



nickelodeon.  
TEENAGE MUTANT NINJA  
**TURTLES**

79103



1



2



3



4





[LEGO.com/brickseparator](https://LEGO.com/brickseparator)





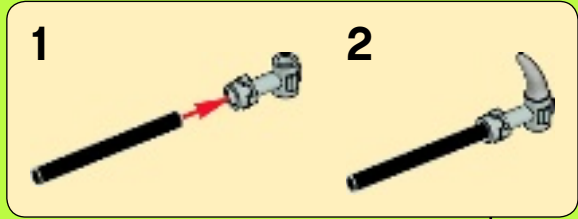



1



2



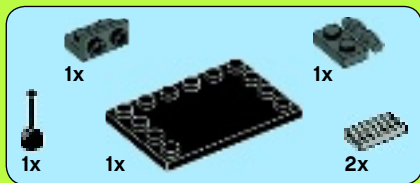

**3**

**1**



**2**

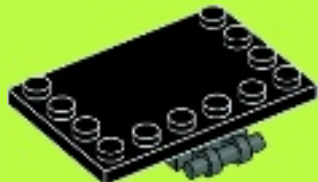

**3**



**4**

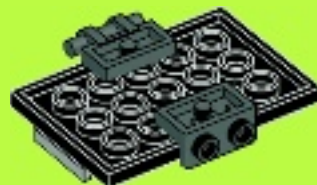

5



6

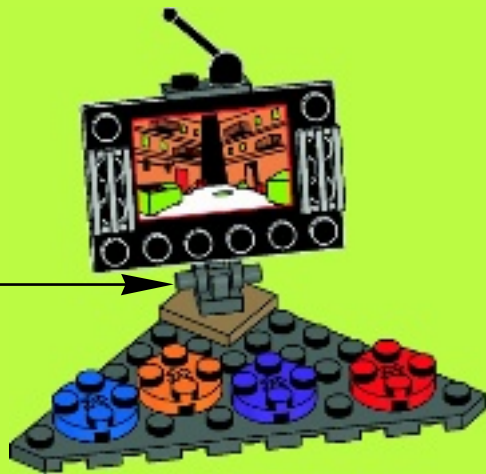
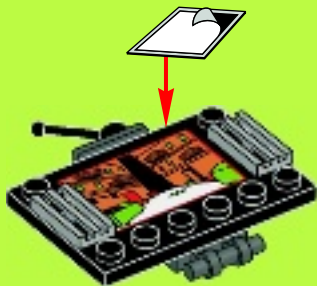



1

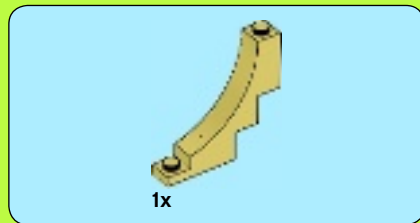

2

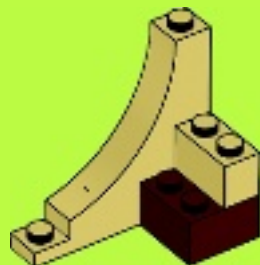



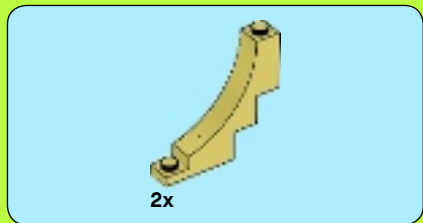

3

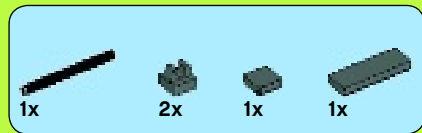
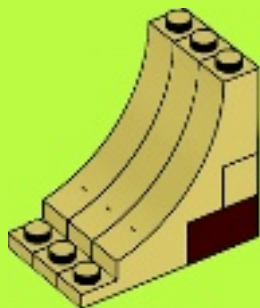

4





1x



2x

1

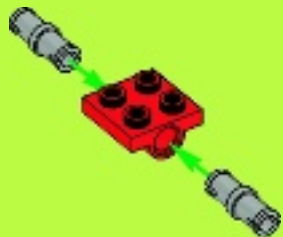

2x

2





1x

3



4x

4



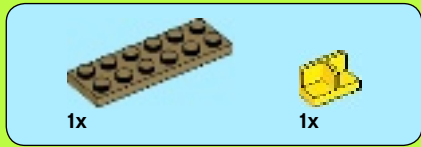

5

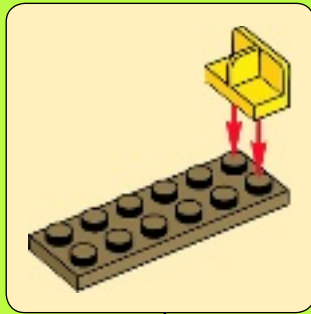

6

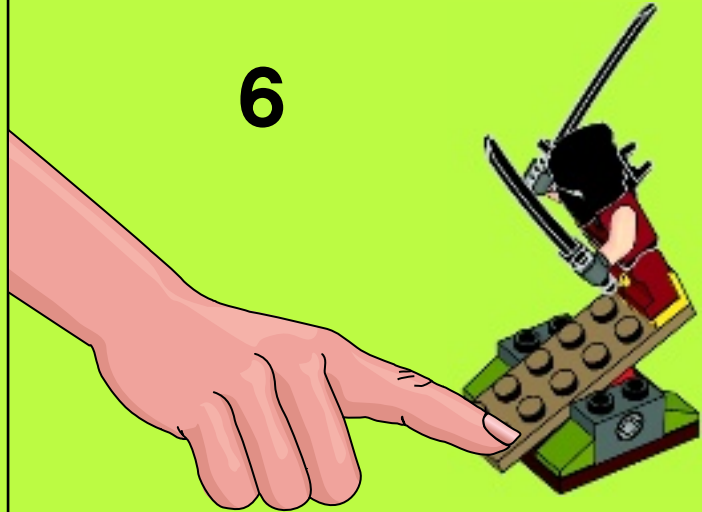



1x



1x

# 1



1x



1x

# 2







1x

3



1x



1x

4





1x



2x



1x

5



1x



1x

6





2x



1x

7



1x

8





# 9



# 10

1



2





1

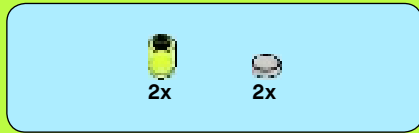

2

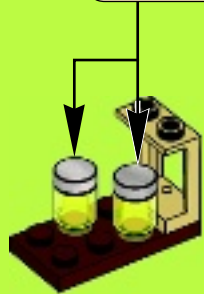





1x

3



1x

4





2x

5



1x

6





1x



1x



1x

7



1x



1x



1x

8





1x

1



2x

2



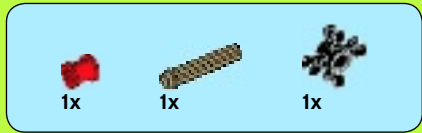

# 3

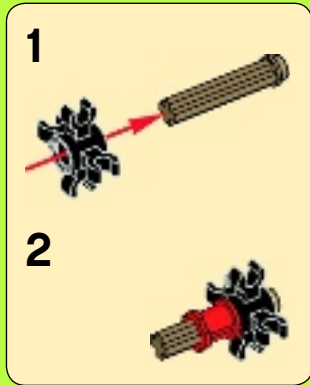

# 4

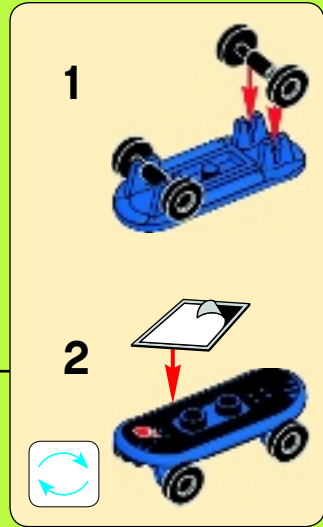





1

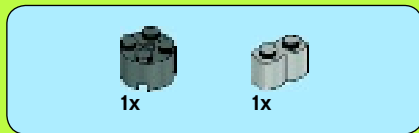

2





1x



2x

3



1x

4





1x



1x

5



1x



1x



3x



1x

6

1

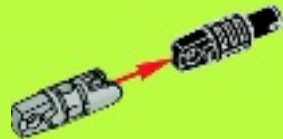

2

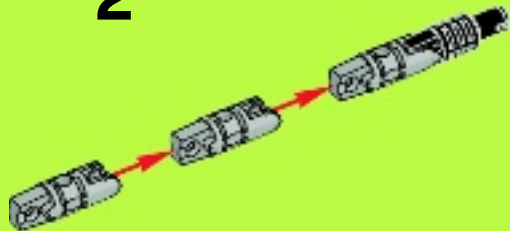

3



4

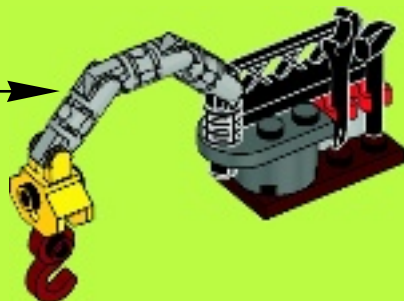
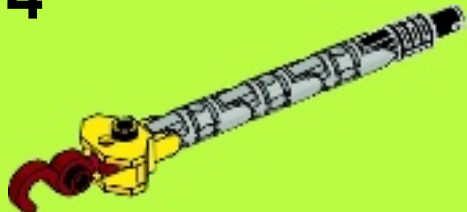

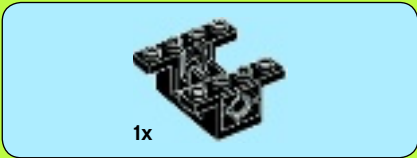

1



2



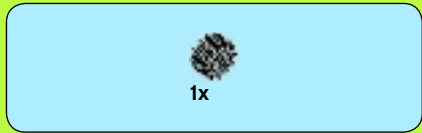

3

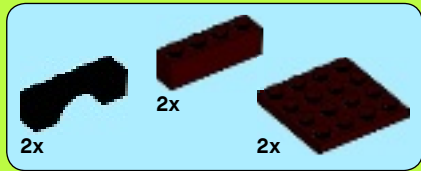

4

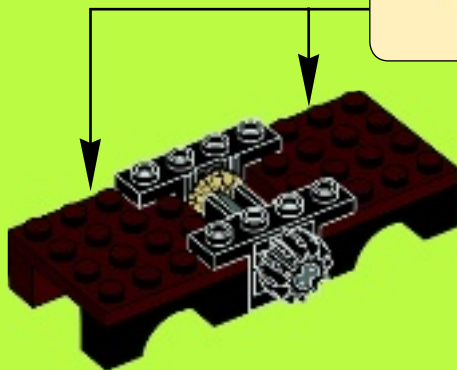
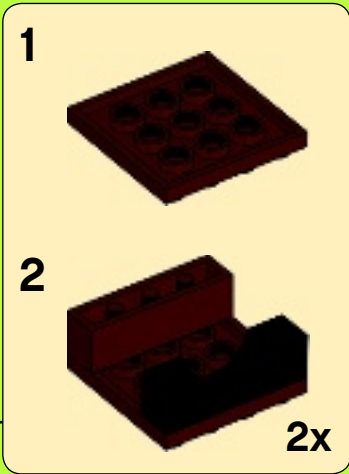



8x

5



2x



2x

6





1x



1x

7

1



2



1x

8







1x

9



2x

10

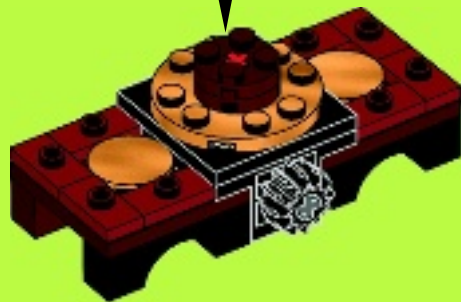

11

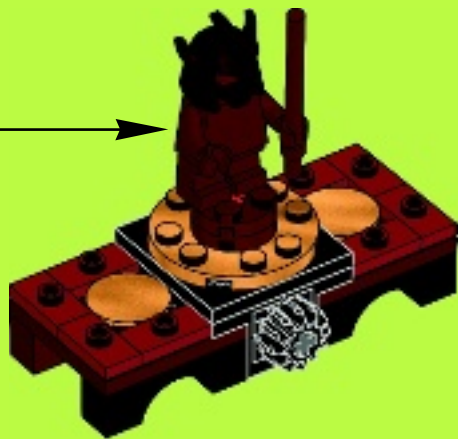
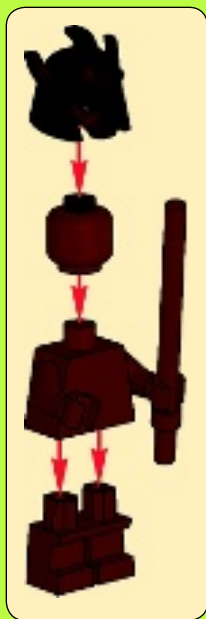

12

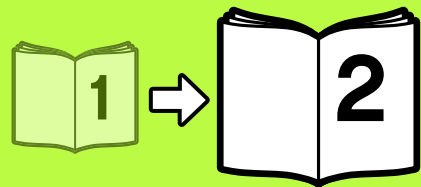
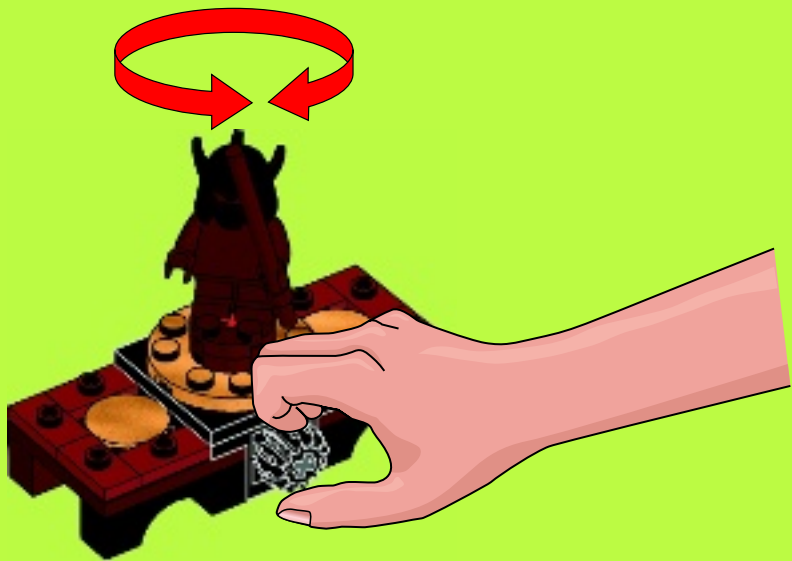



# WIN!

Go to [www.LEGOsurvey.com/product](http://www.LEGOsurvey.com/product) to fill out a survey for a chance to win a cool LEGO® Product.

No purchase necessary.

Open to all residents where not prohibited.



## [www.LEGOsurvey.com/product](http://www.LEGOsurvey.com/product)

### GEWINNE!

Nimm an der Umfrage auf [www.LEGOsurvey.com/product](http://www.LEGOsurvey.com/product) teil und hab die Chance ein cooles LEGO® Produkt zu gewinnen! Die Teilnahme am Gewinnspiel führt zu keinerlei Kaufverpflichtungen. Teilnahme in allen nicht ausgeschlossenen Ländern möglich.

### WIN!

Ga naar [www.LEGOsurvey.com/product](http://www.LEGOsurvey.com/product), vul een enquêteformulier in en maak kans op een cool LEGO® product. Geen aankoopverplichting. Iedereen mag deelnemen, uitgezonderd ingezetenden van landen waar een enquêteverbod geldt.

### GAGNE!

Visite [www.LEGOsurvey.com/product](http://www.LEGOsurvey.com/product) pour répondre à un questionnaire et avoir une chance de gagner un produit LEGO® très cool! Aucune obligation d'achat. Ouvert à tous les résidents des pays autorisés.

### 当てよう!

[www.LEGOsurvey.com/product](http://www.LEGOsurvey.com/product) にアクセスして、アンケートにご記入ください。当選者にはレゴ®製品を差し上げます。お買い上げの必要はありません。禁止されていない限り、すべての皆様にご利用いただけます。

6036750 / 6036752

LEGO and the LEGO logo are trademarks of the/son des marques de commerce de/son marcas registradas de LEGO Group. ©2013 The LEGO Group.

©2013 Viacom International Inc. All Rights Reserved. Teenage Mutant Ninja Turtles and all related titles, logos and characters are trademarks of Viacom International Inc. ©2013 Viacom International Inc. Tous droits réservés. Les Tortues Ninja et tous les titres, logos et personnages qui s'y rapportent sont des marques de commerce de Viacom International Inc. ©2013 Viacom International Inc. Todos los derechos reservados. Teenage Mutant Ninja Turtles y todos los títulos, logotipos y personajes relacionados son marcas comerciales de Viacom International Inc.



LEGO.com





nickelodeon  
TEENAGE MUTANT NINJA  
TURTLES

79103





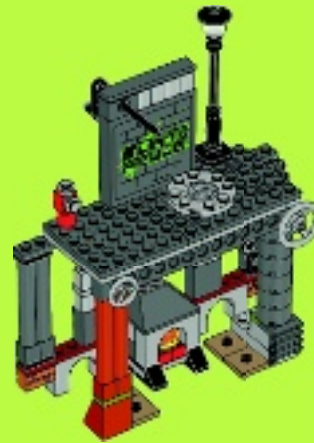

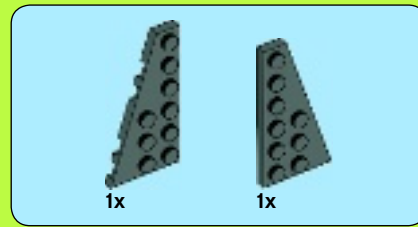
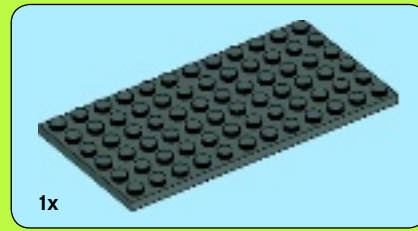

**2**

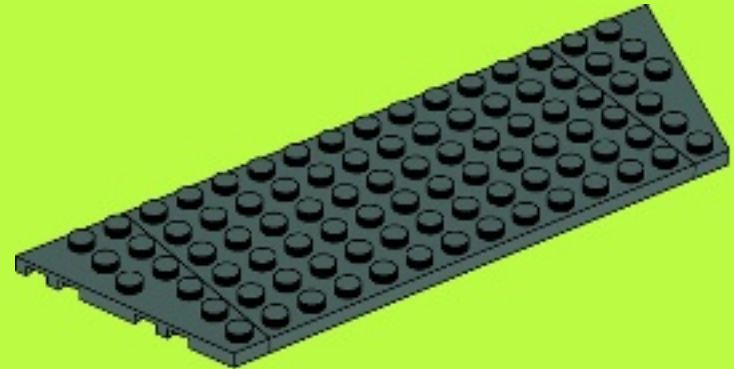



2x

3



4x



2x

4

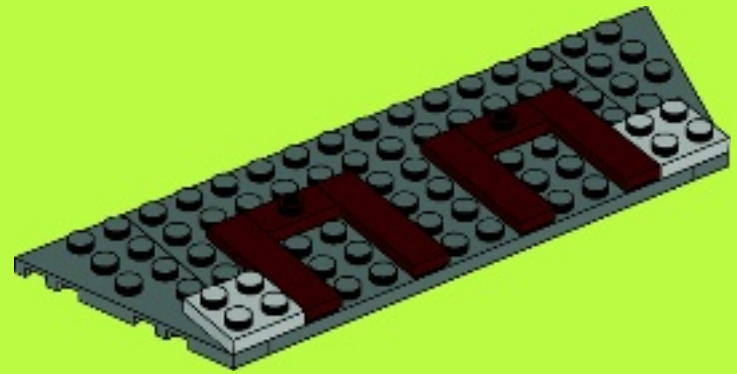





5

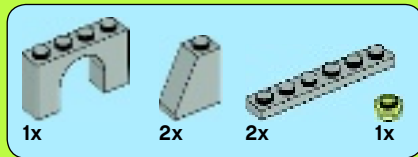
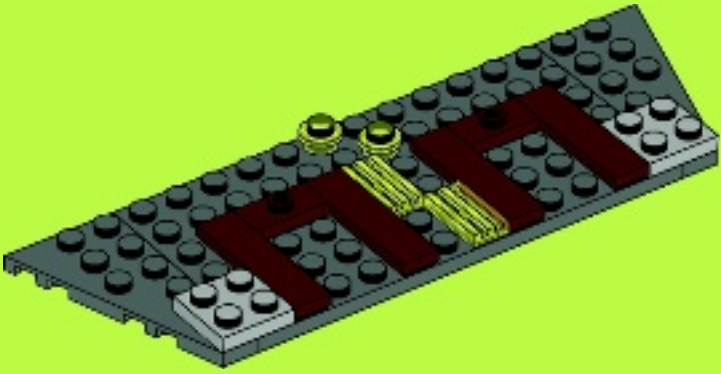

6

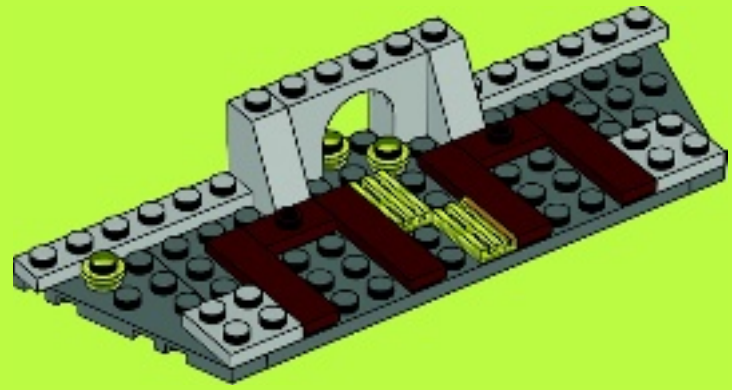

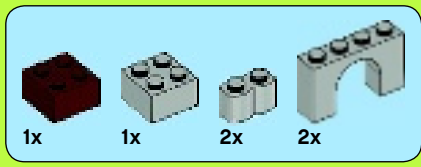

7

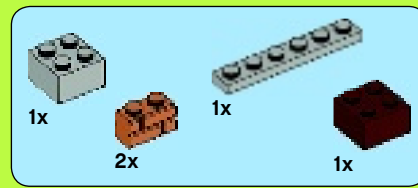
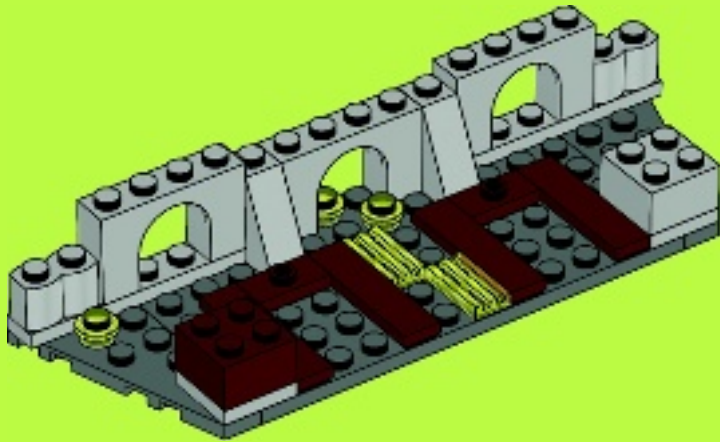

8

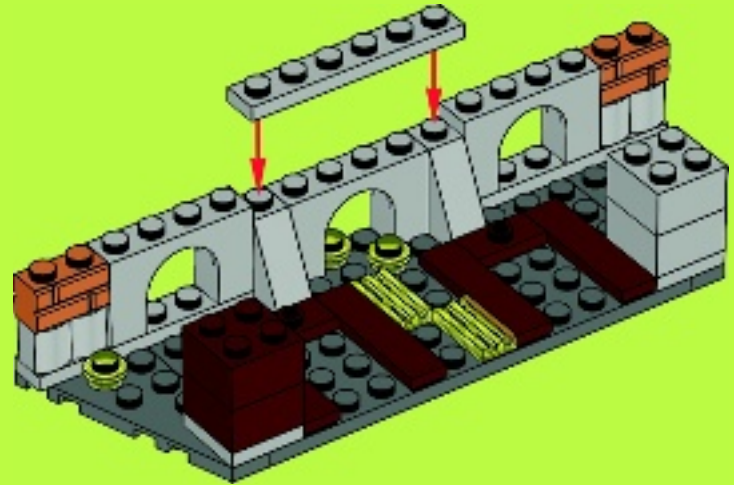



9

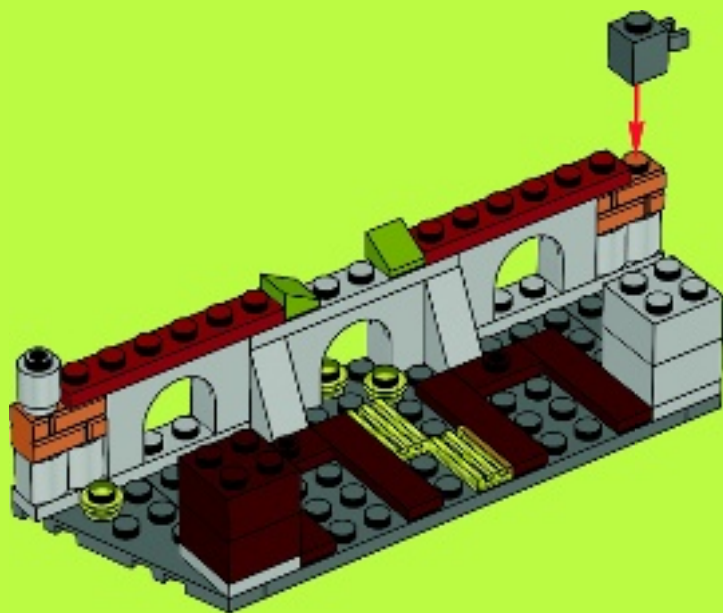

10

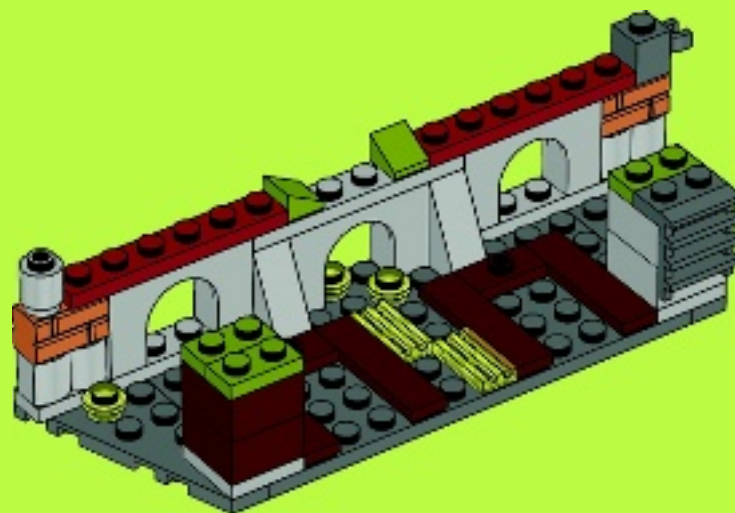

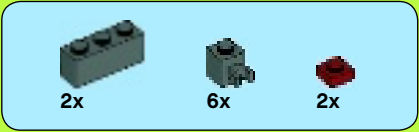

# 11

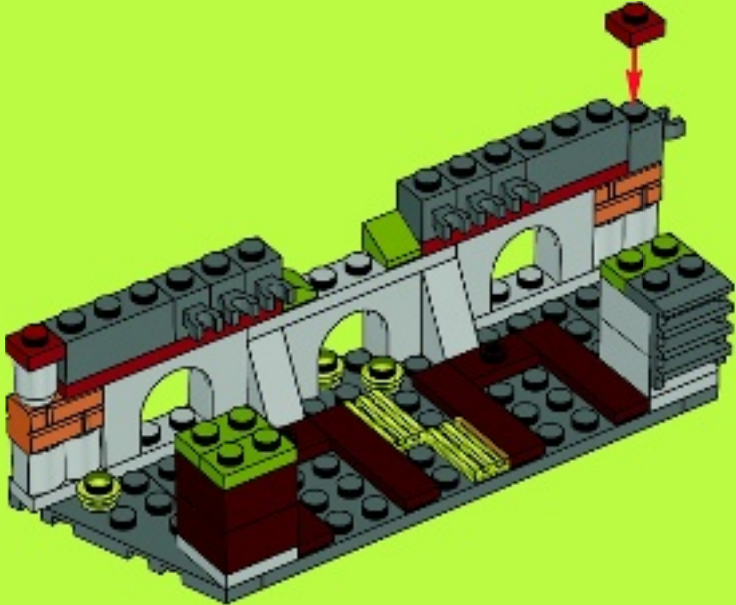

# 12

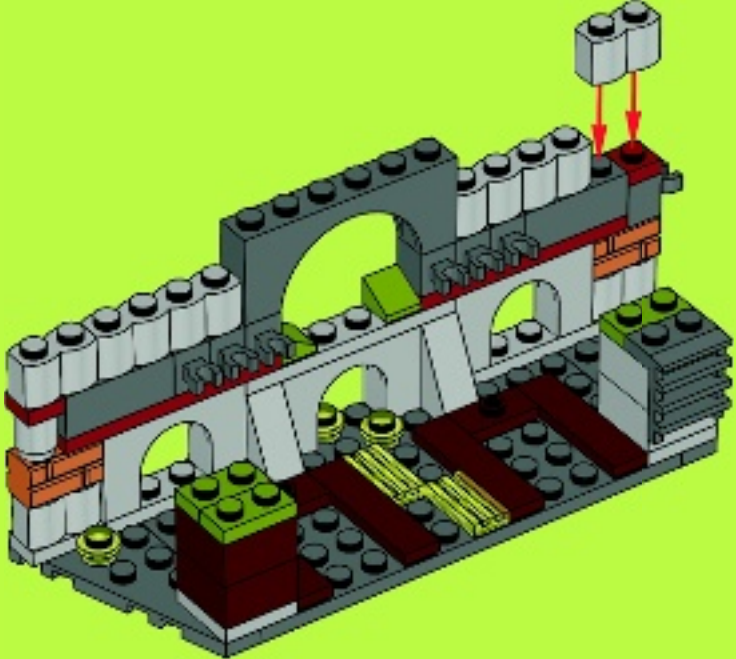

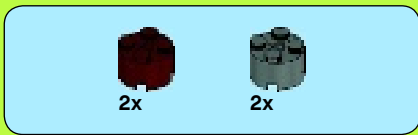

# 13

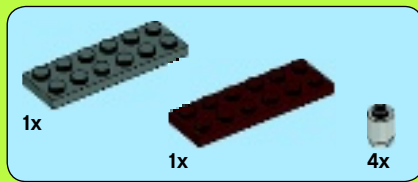
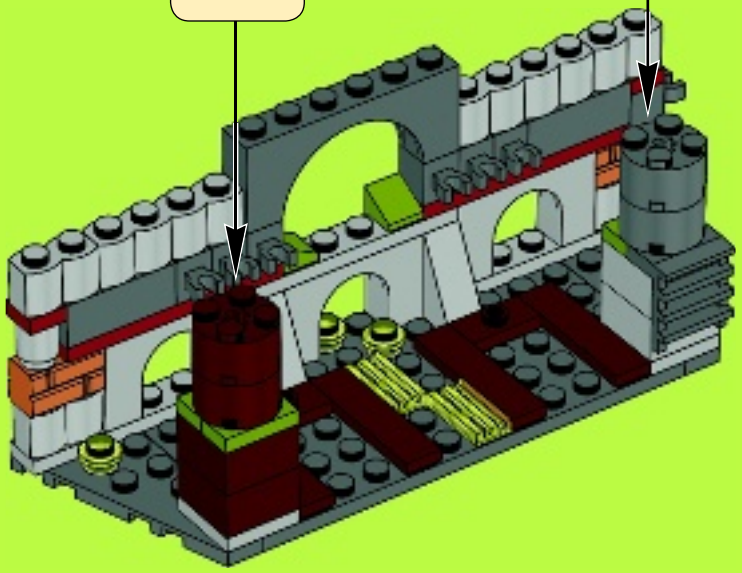
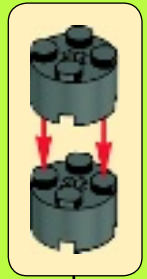

# 14

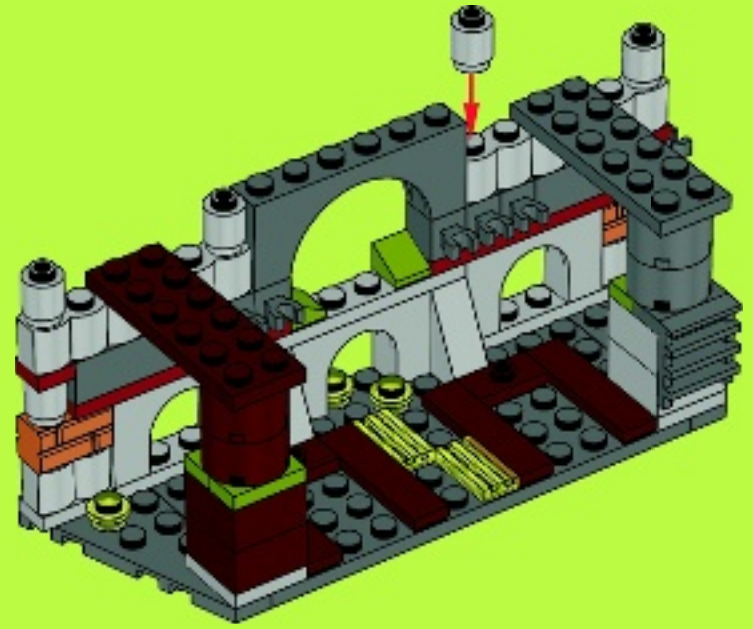





# 15

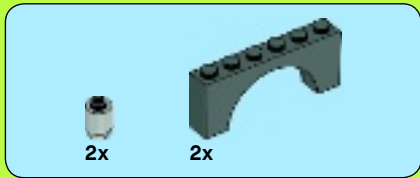
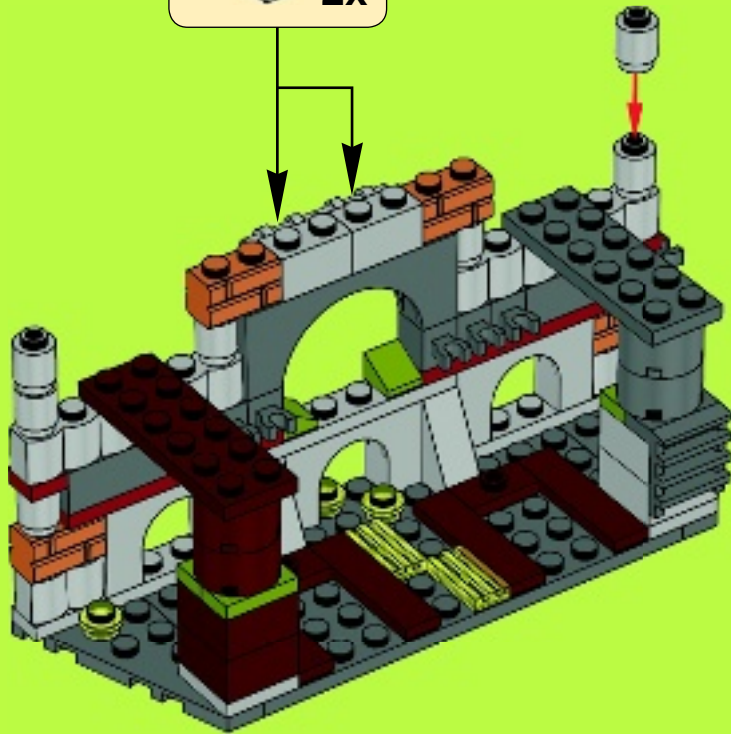

# 16

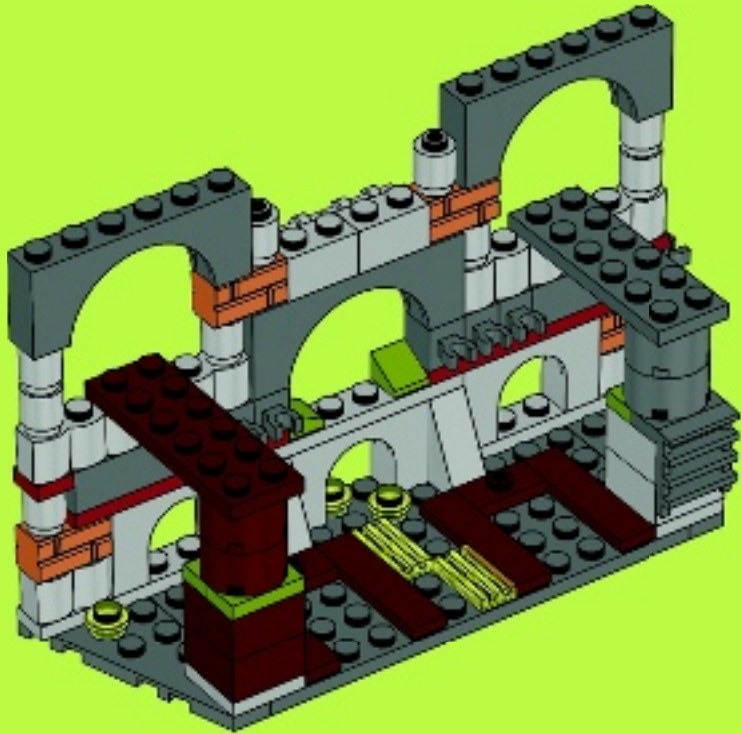



17

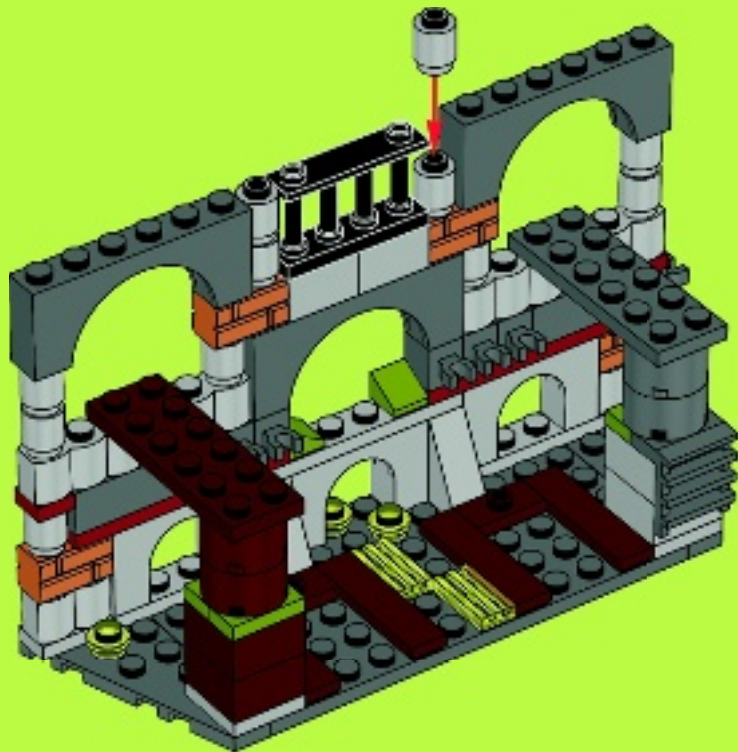

18

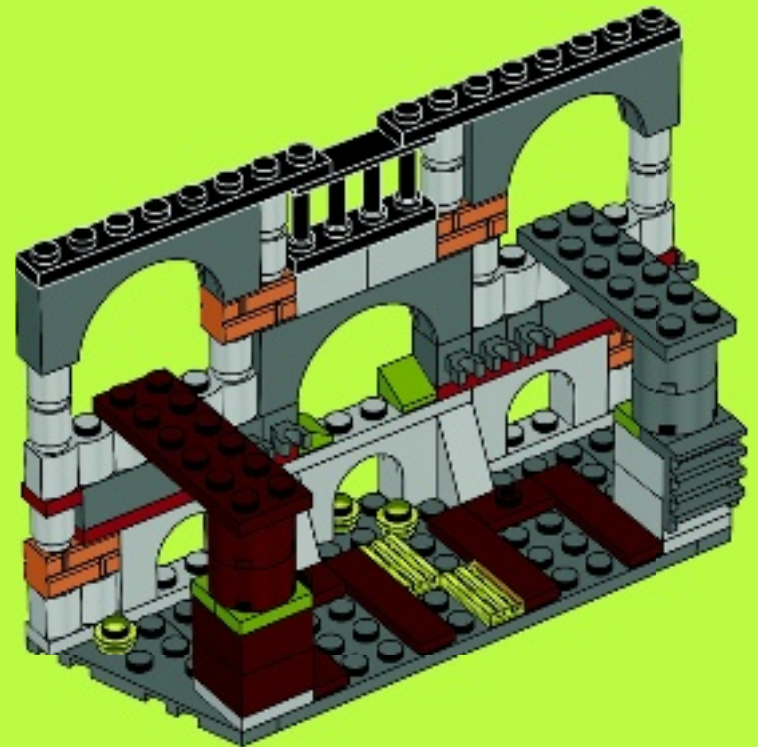



4x

# 19

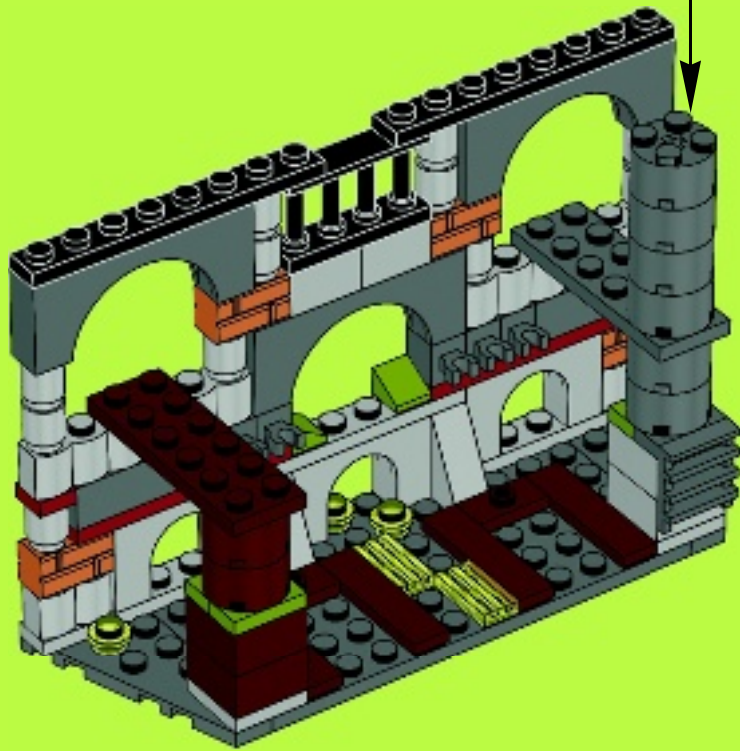
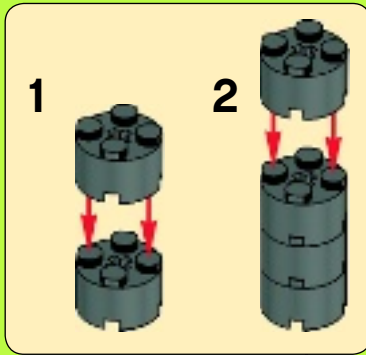

2x

# 20

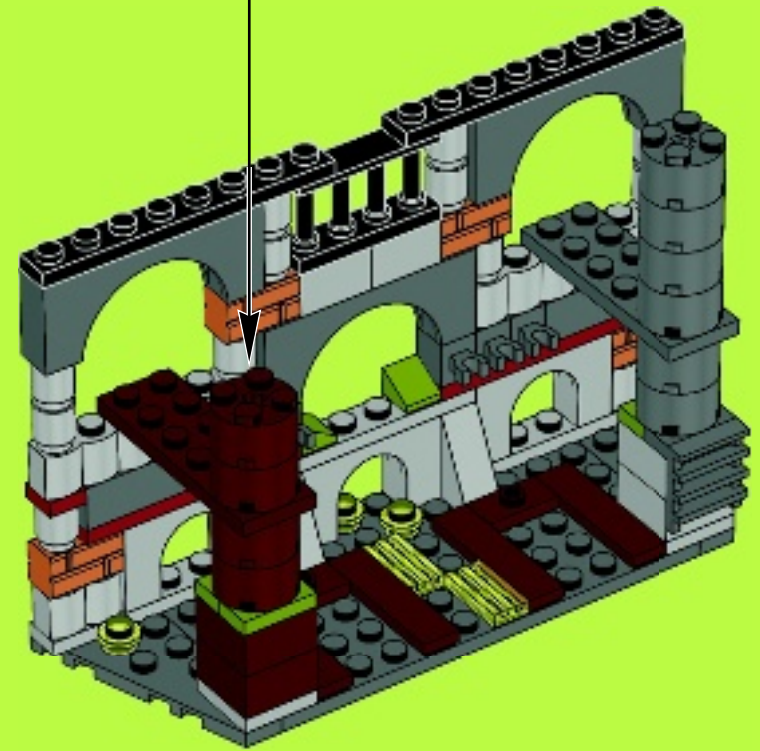





4x

# 21

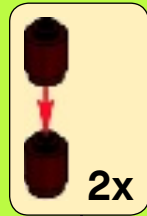

2x

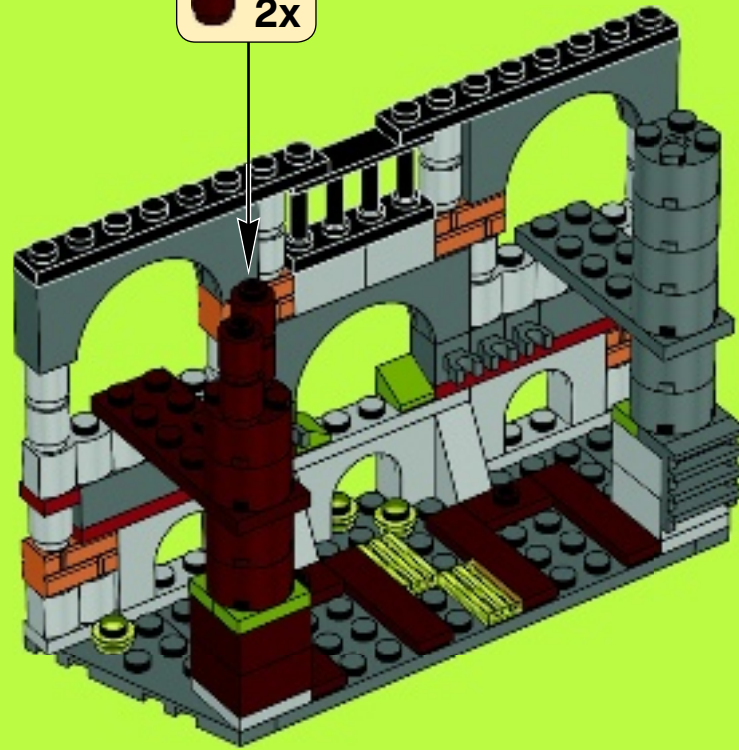

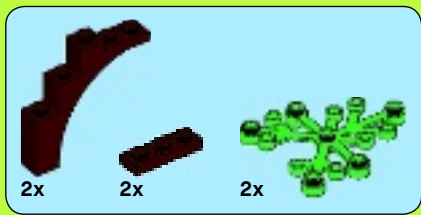

# 22

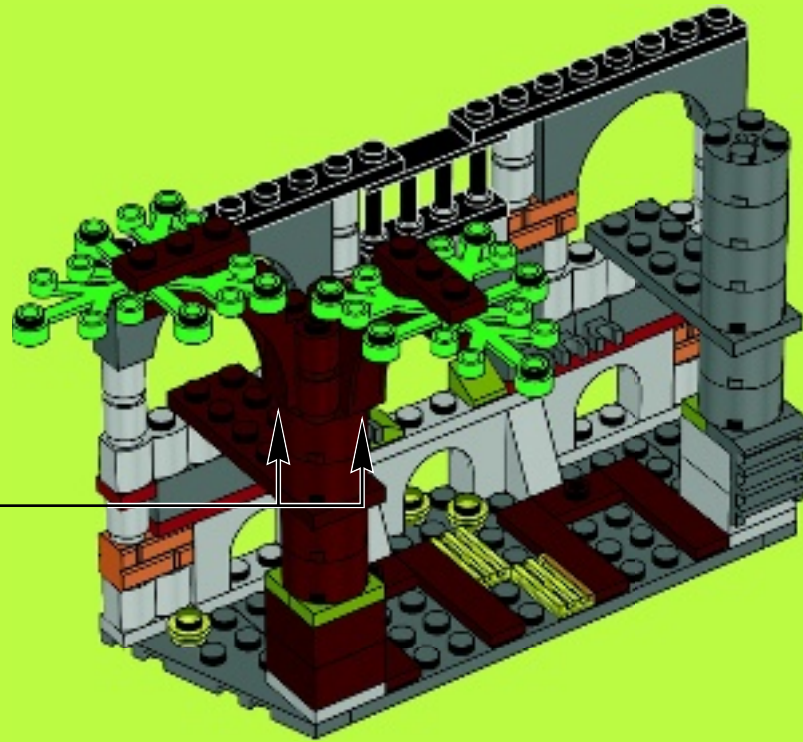
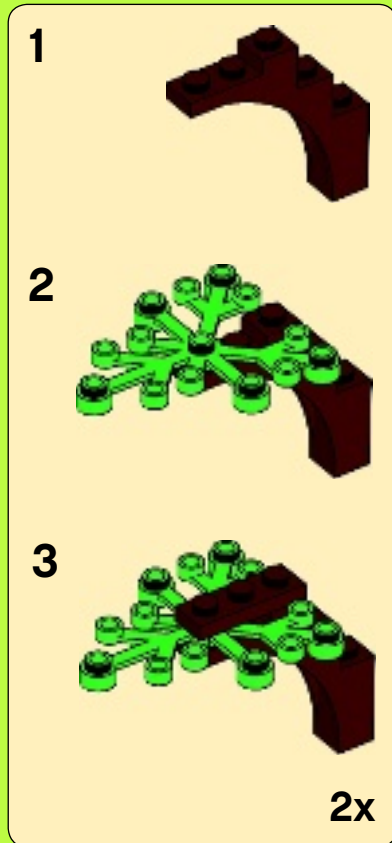

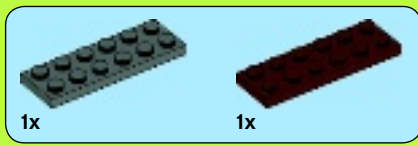

# 23



# 24

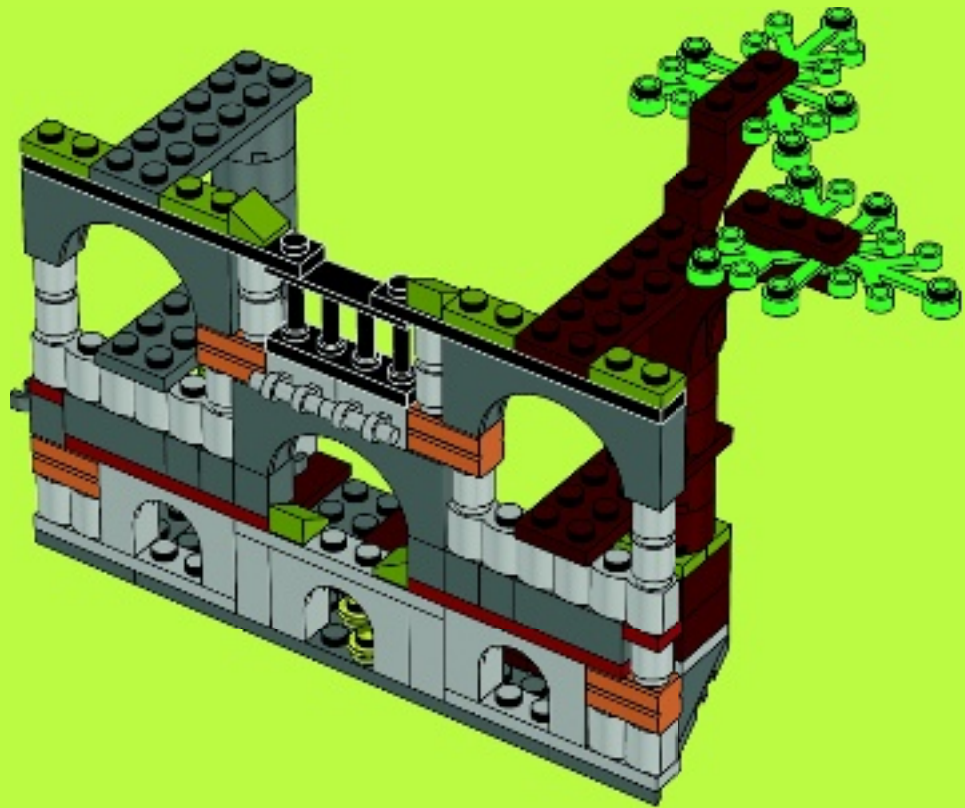

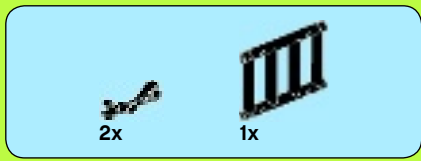

# 25

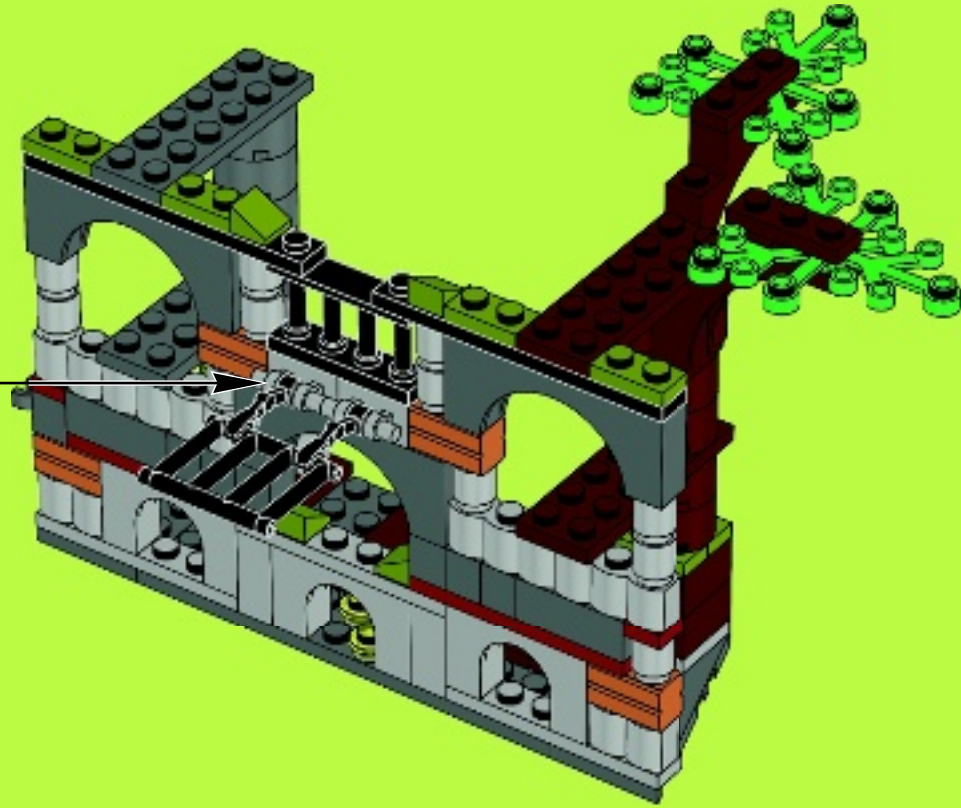
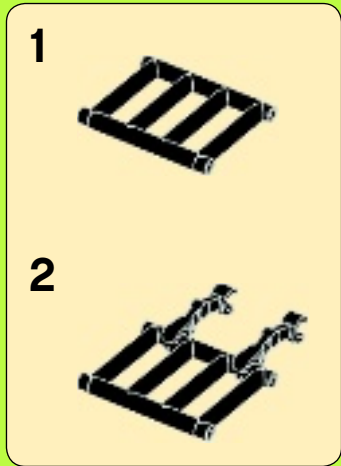





26

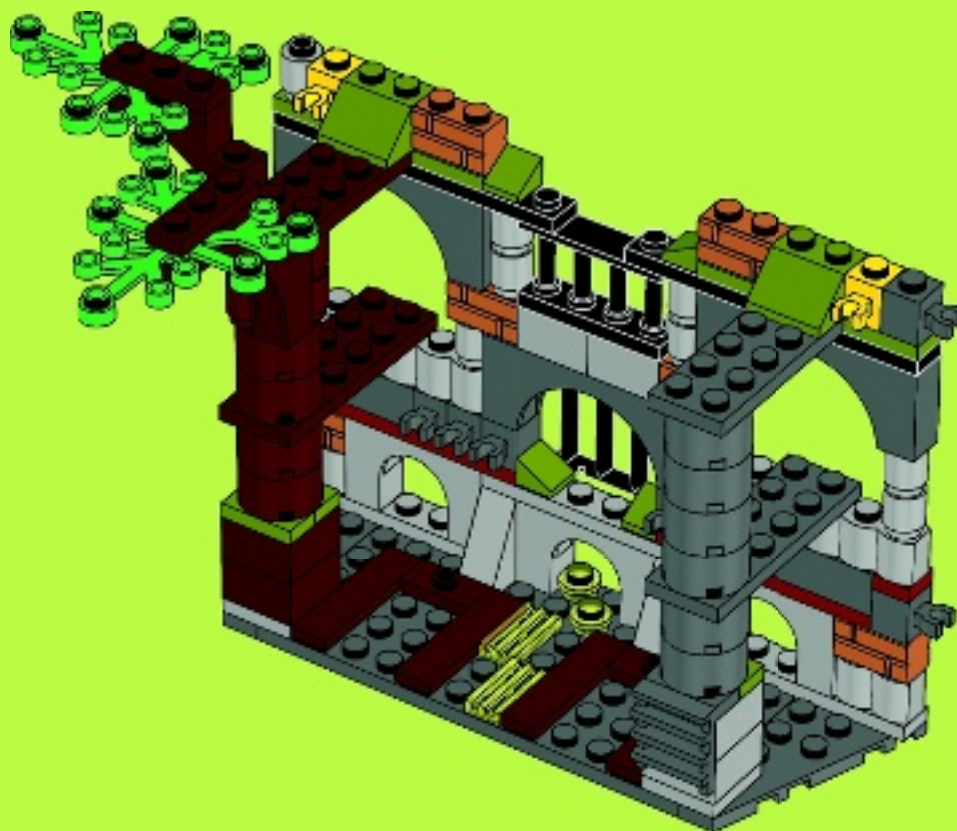

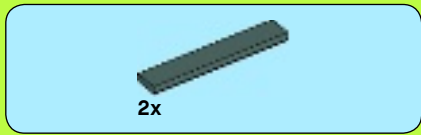

27

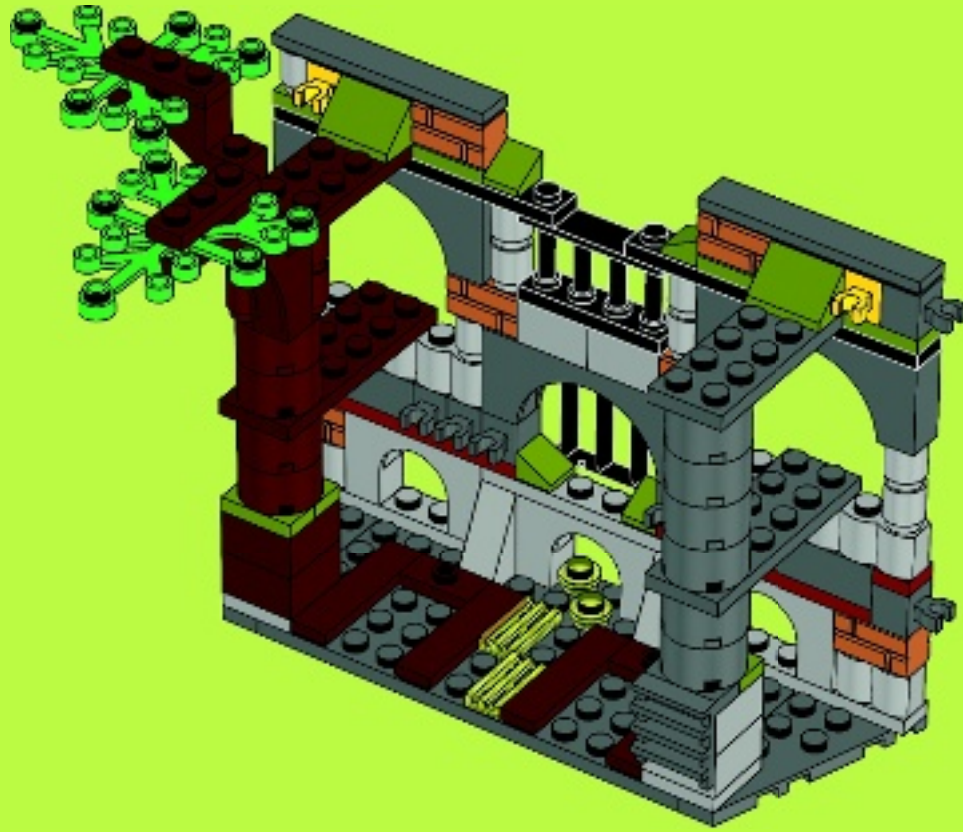

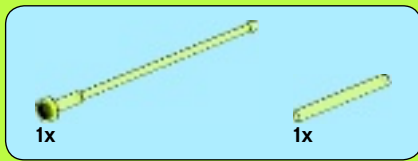

28

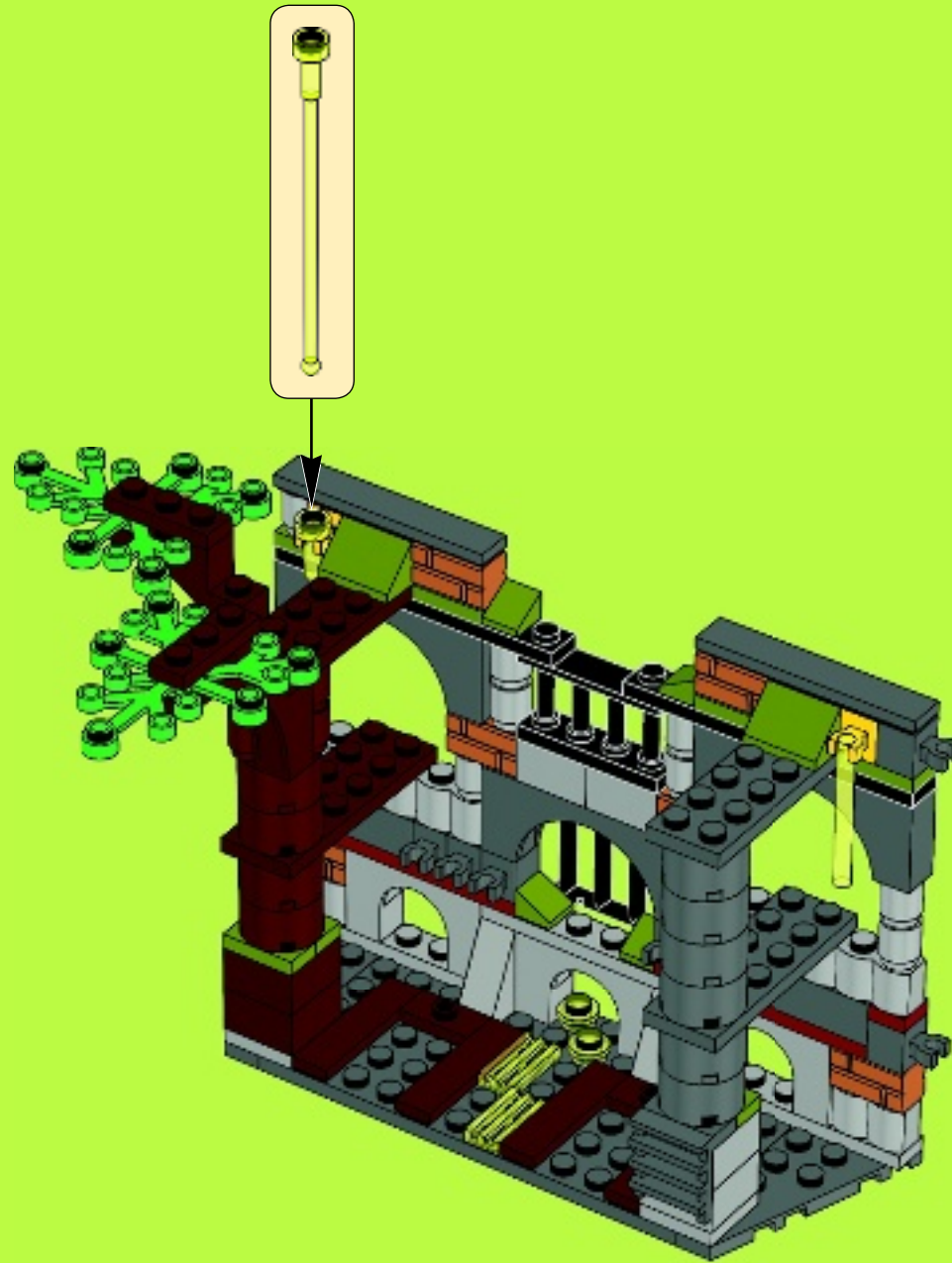

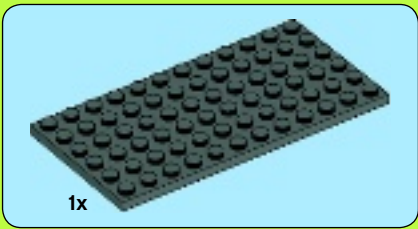

1

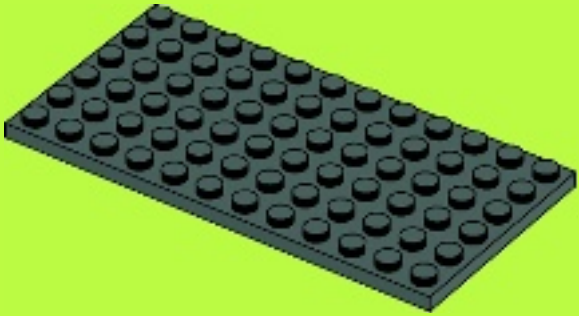
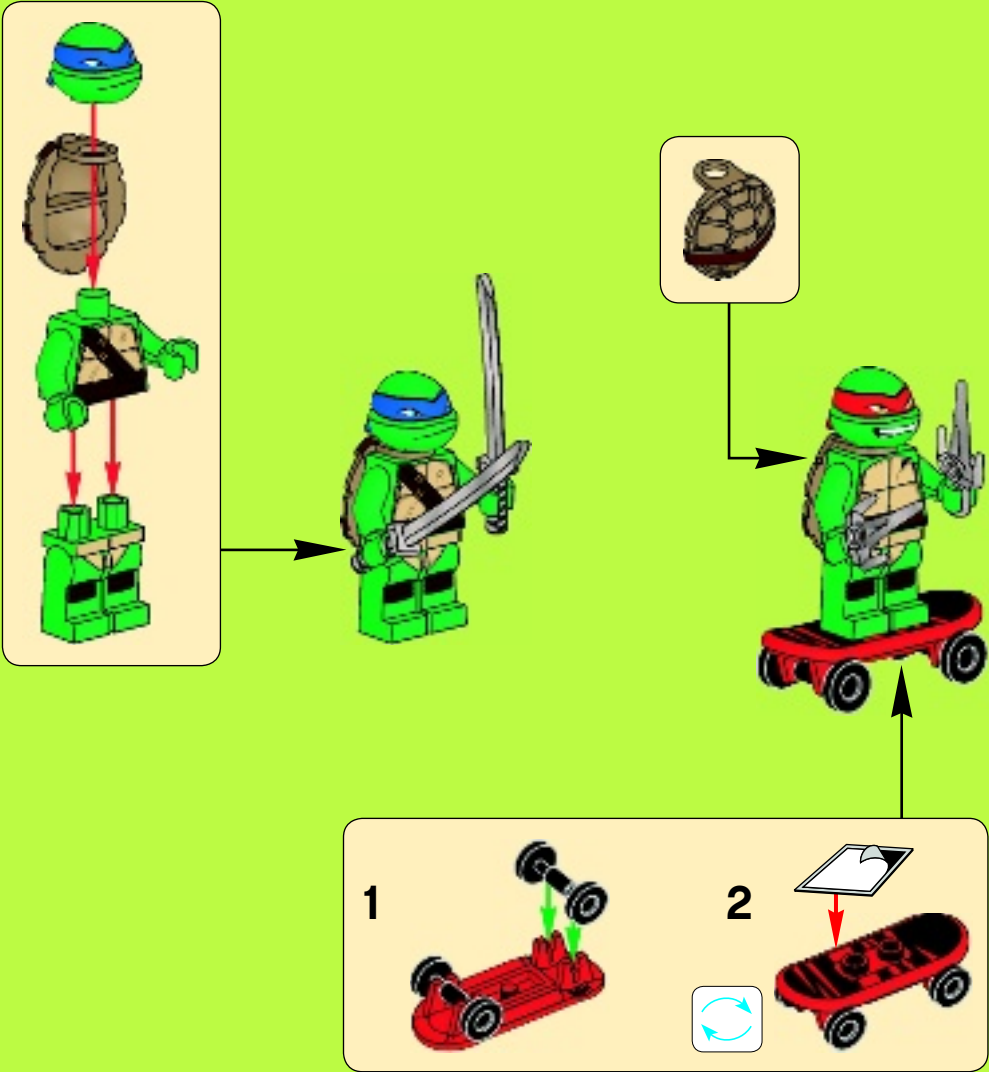



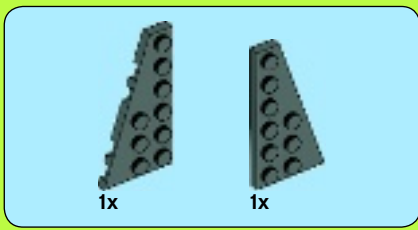

2

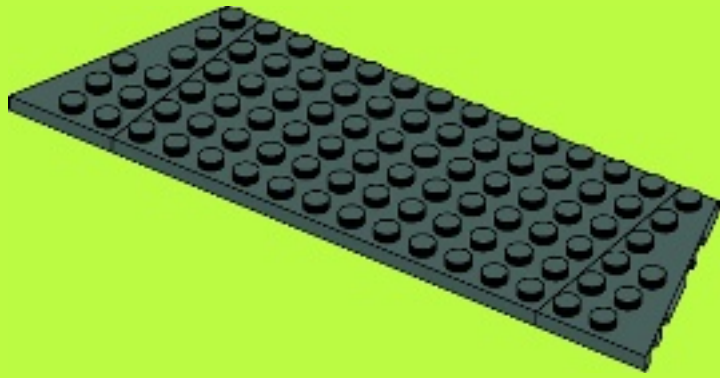

3

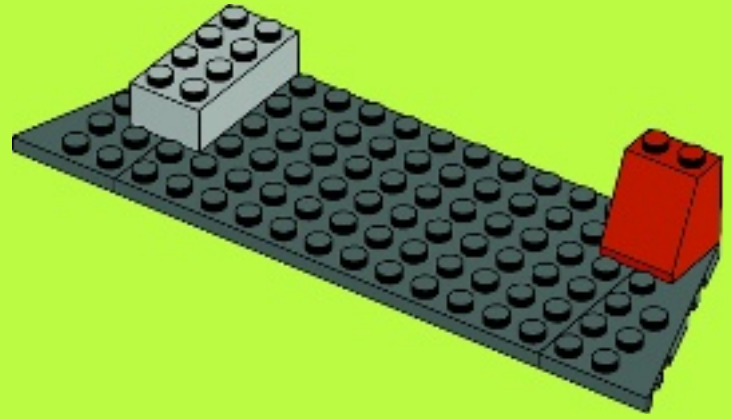

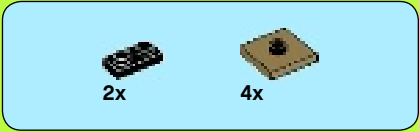

4

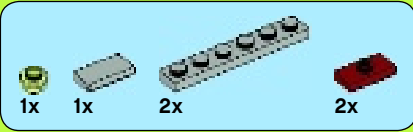
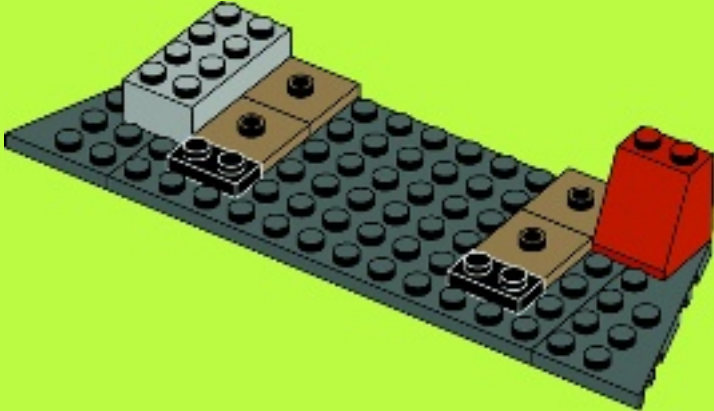

5

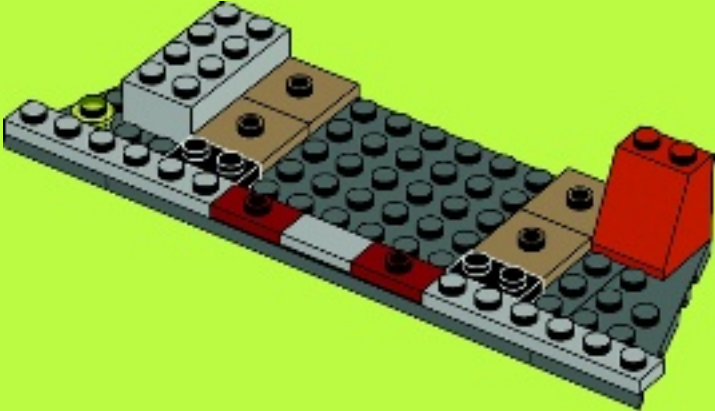



6

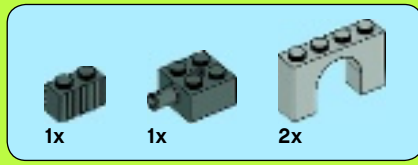
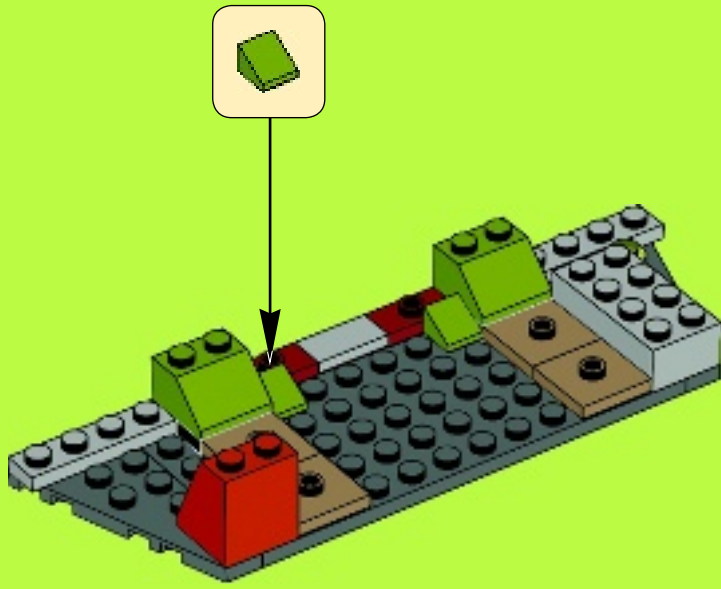

7

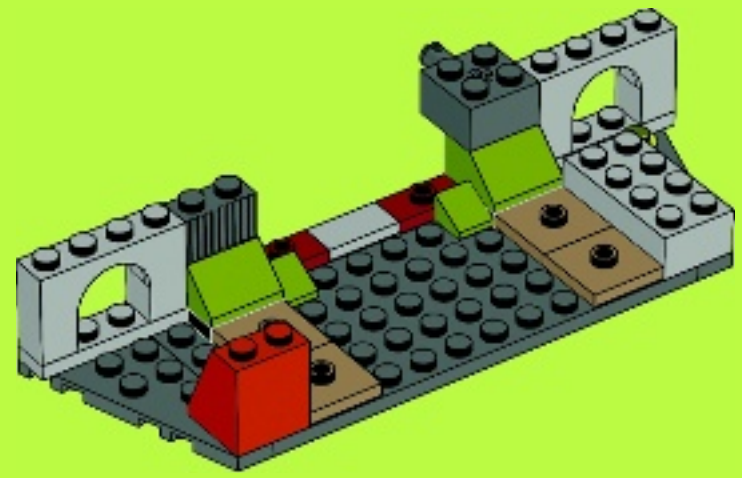

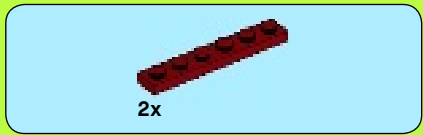

8

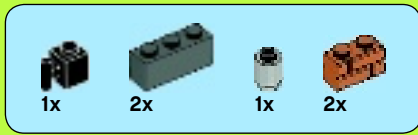
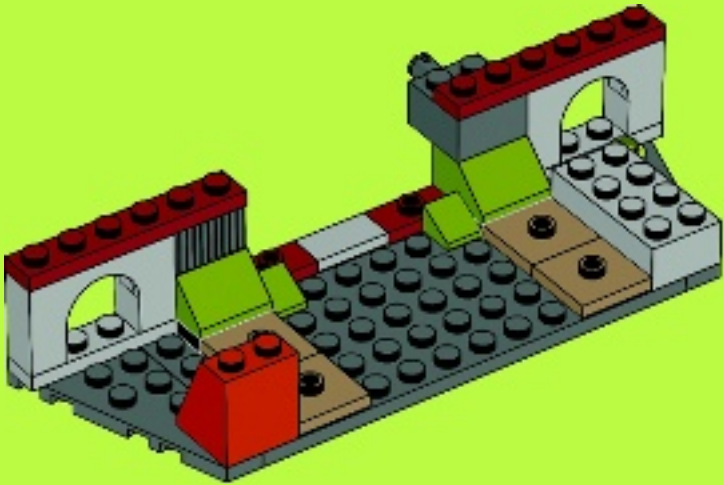

9

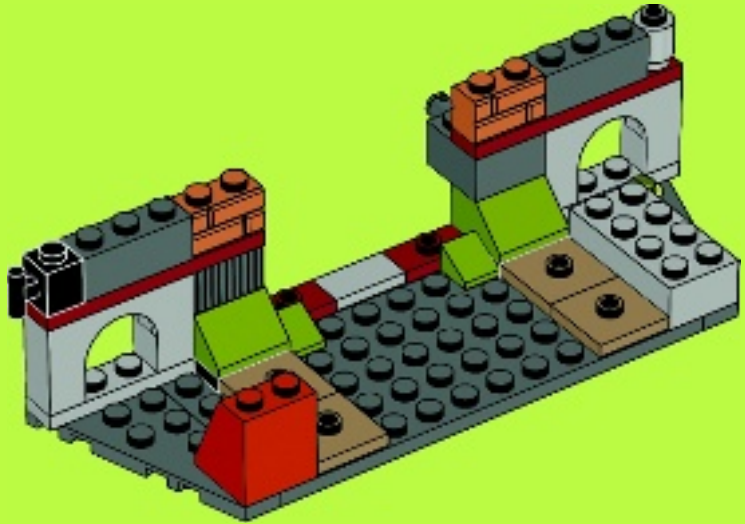

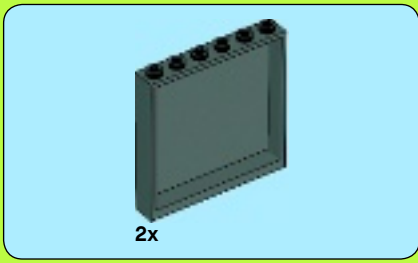

# 10

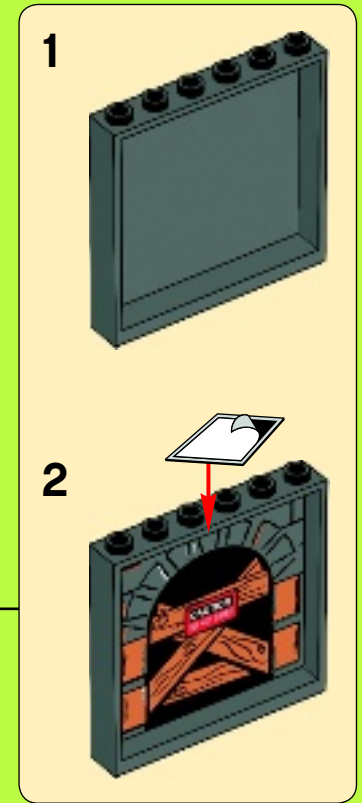
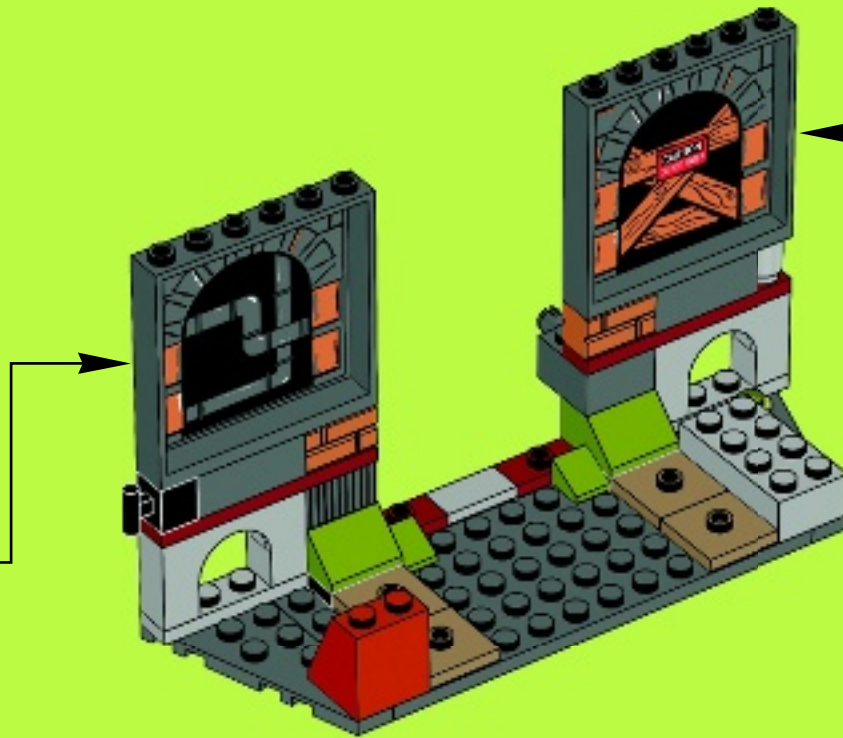
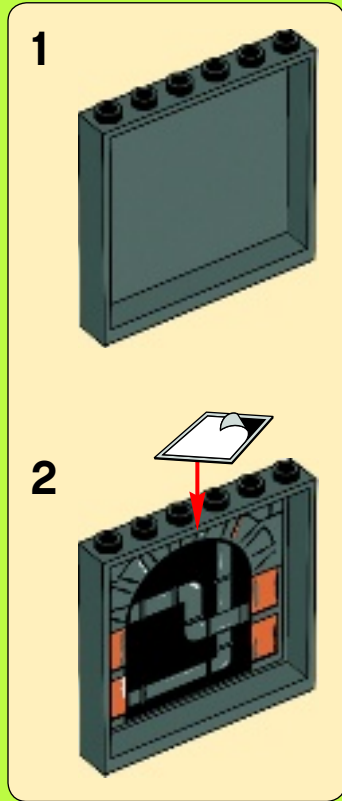



1x

# 11

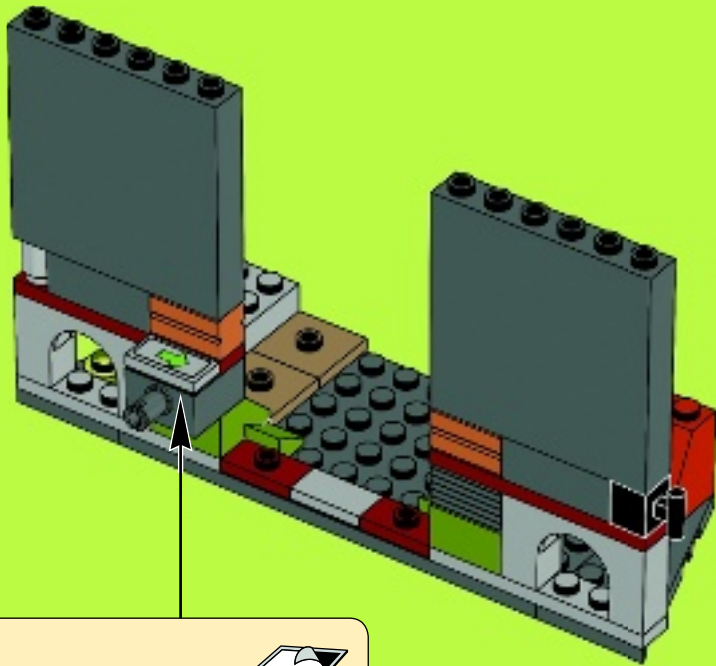

1

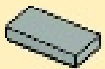

2

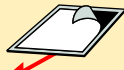

1x



1x

# 12

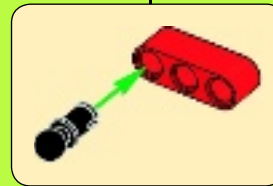
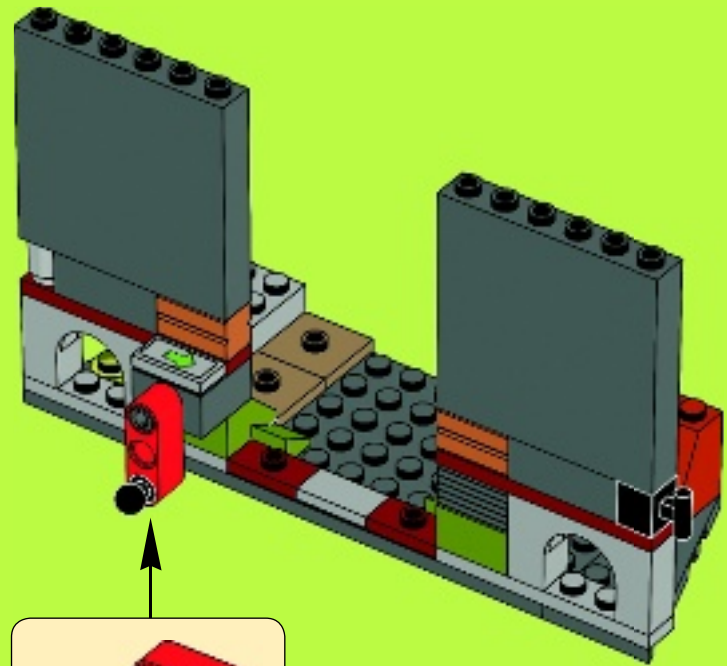

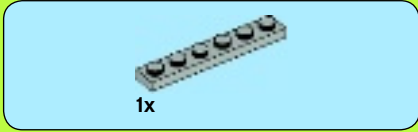

1

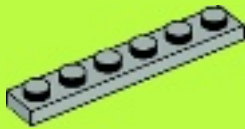

2

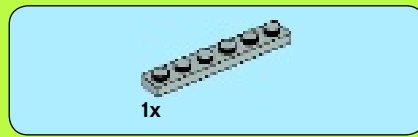
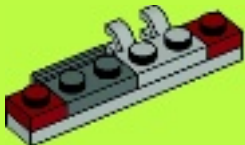

3

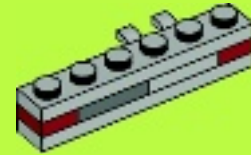

4

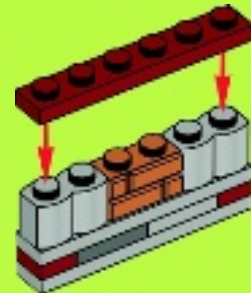



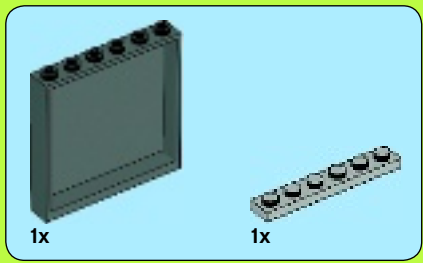

5

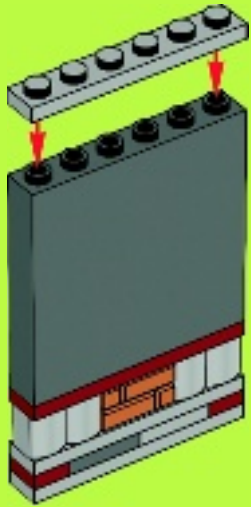

6

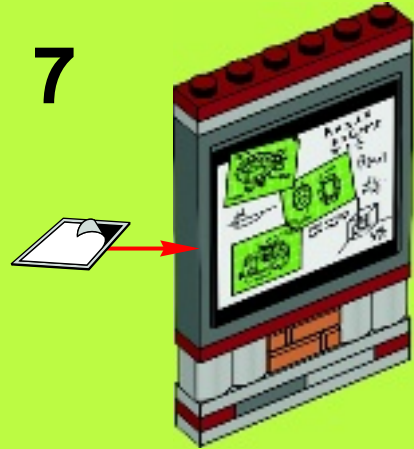
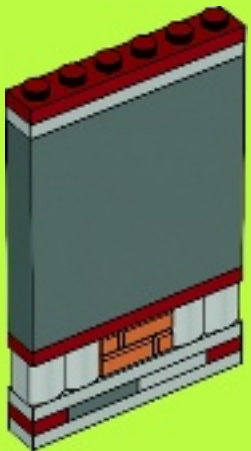

8

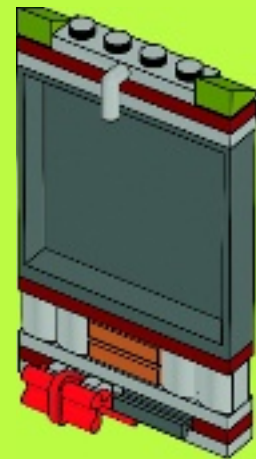



13

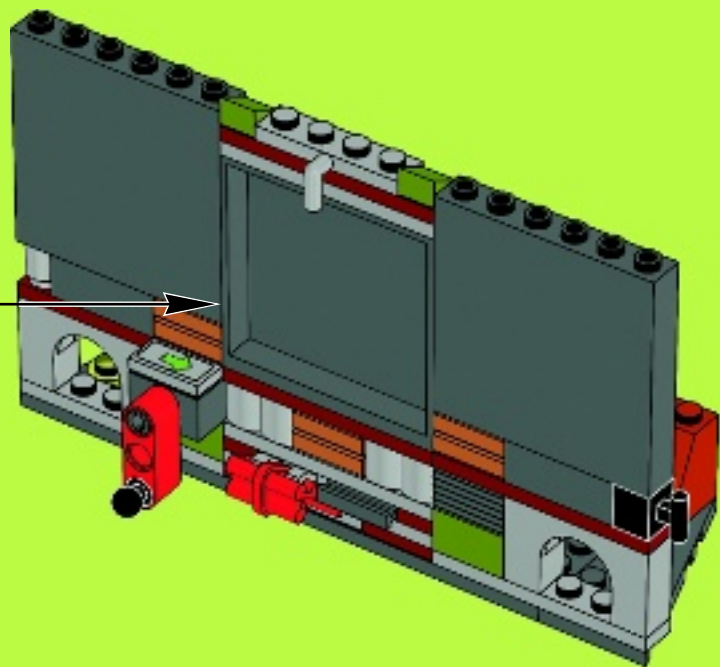

14

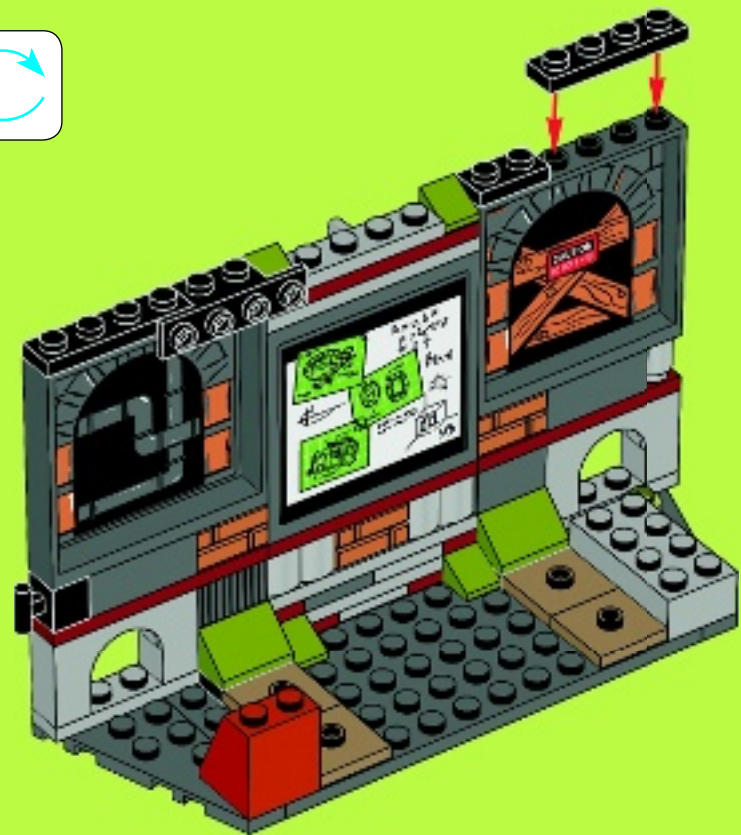



1

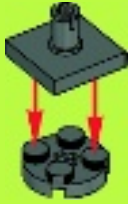

2

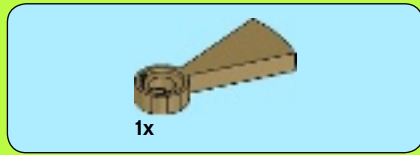
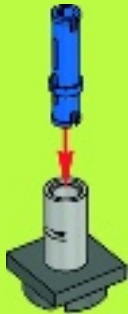

3

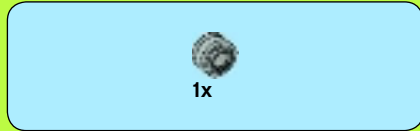
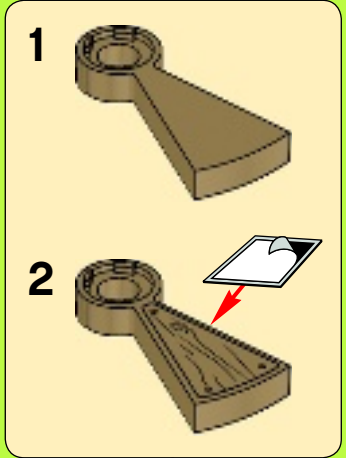
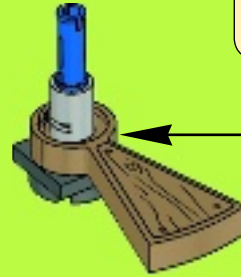

4





5

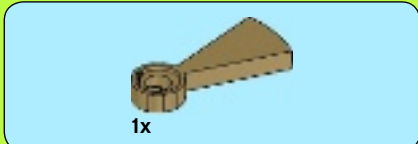

6

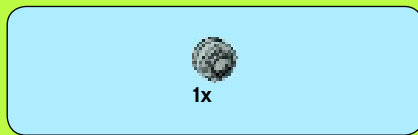
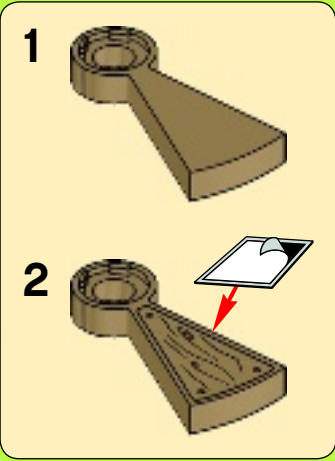
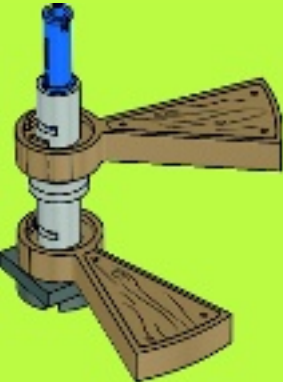

7

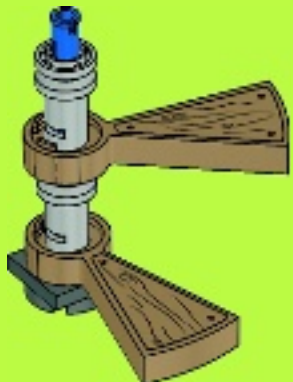

8

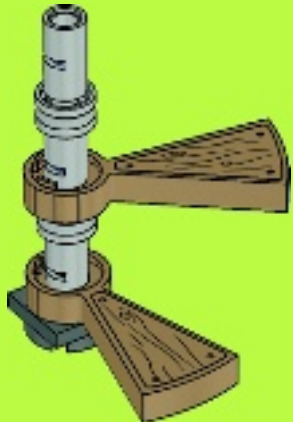

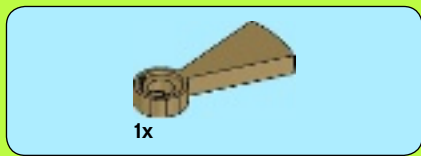

9

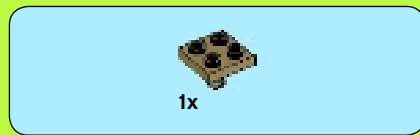
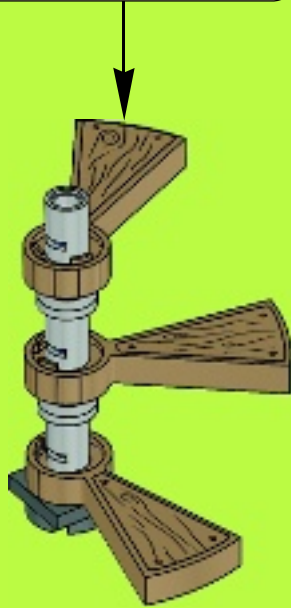
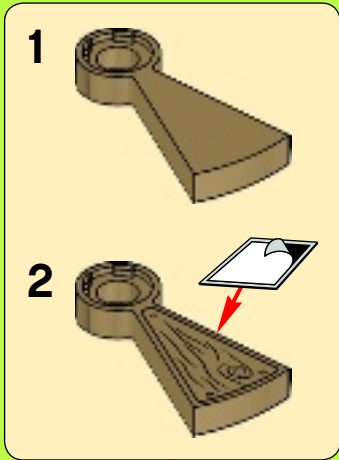

10

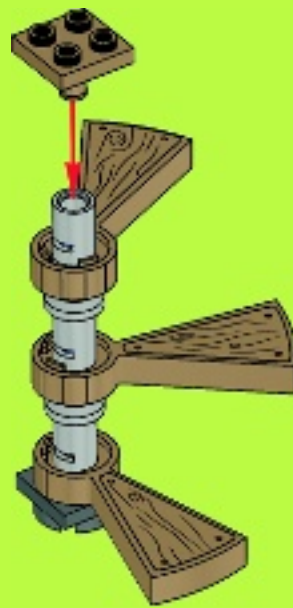



1x

11

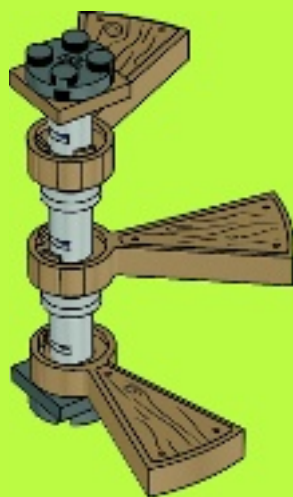

15

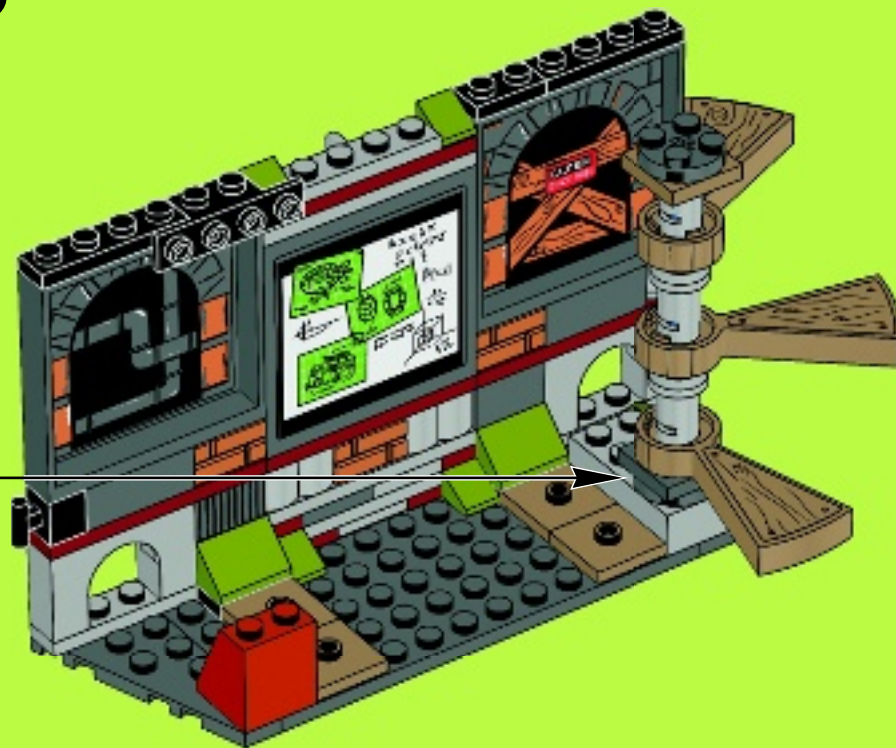



# 16

1



2



3



4



5



6



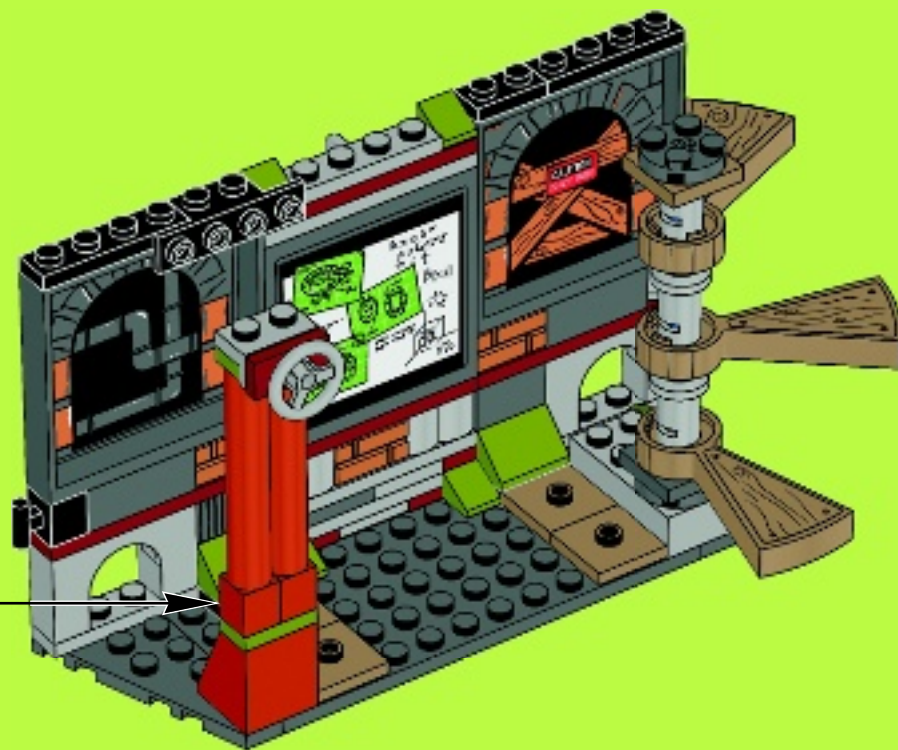





1x



1x



2x

# 17

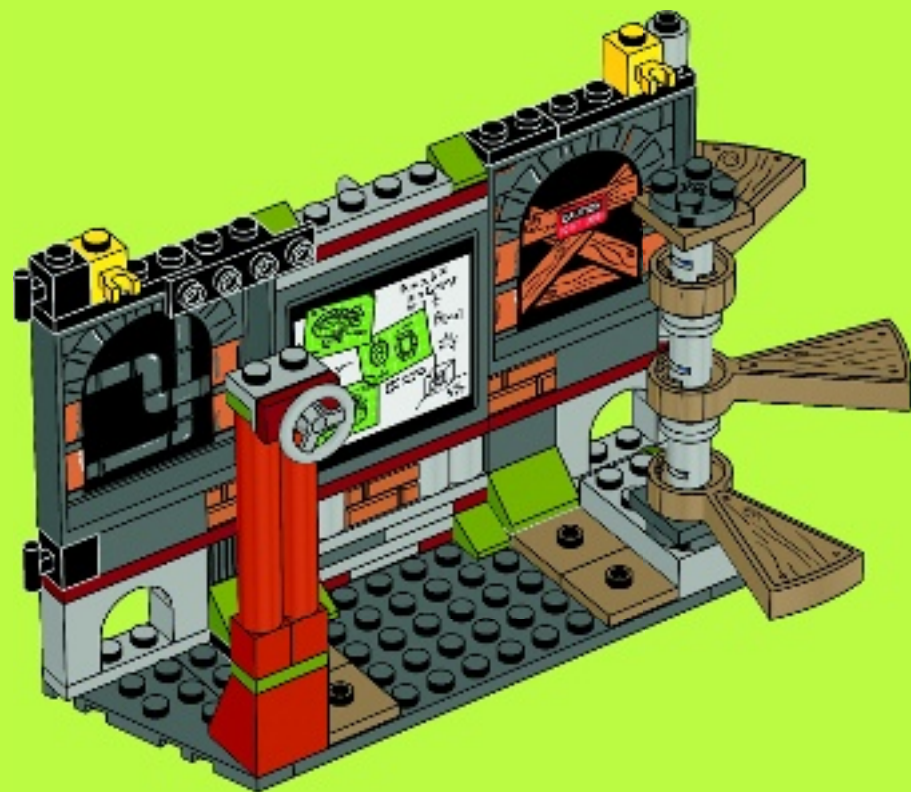

2x



2x

# 18

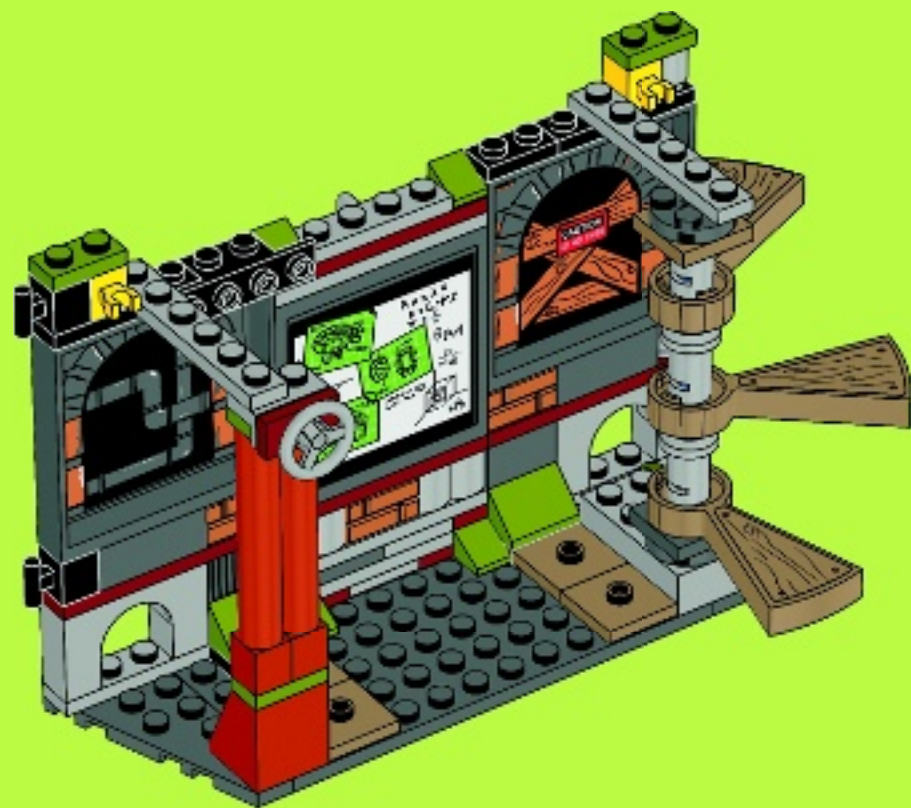



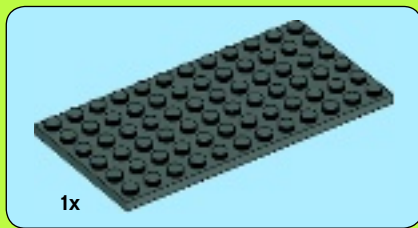

19

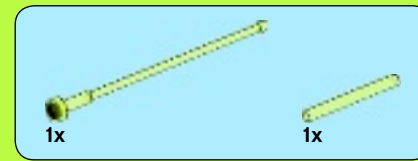
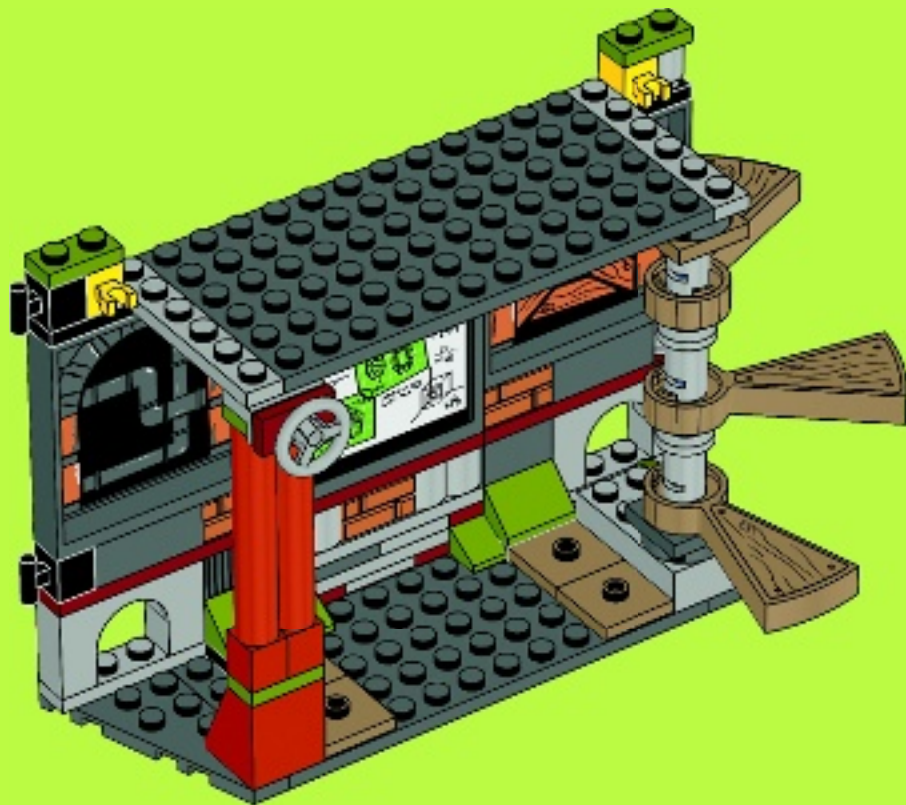

20

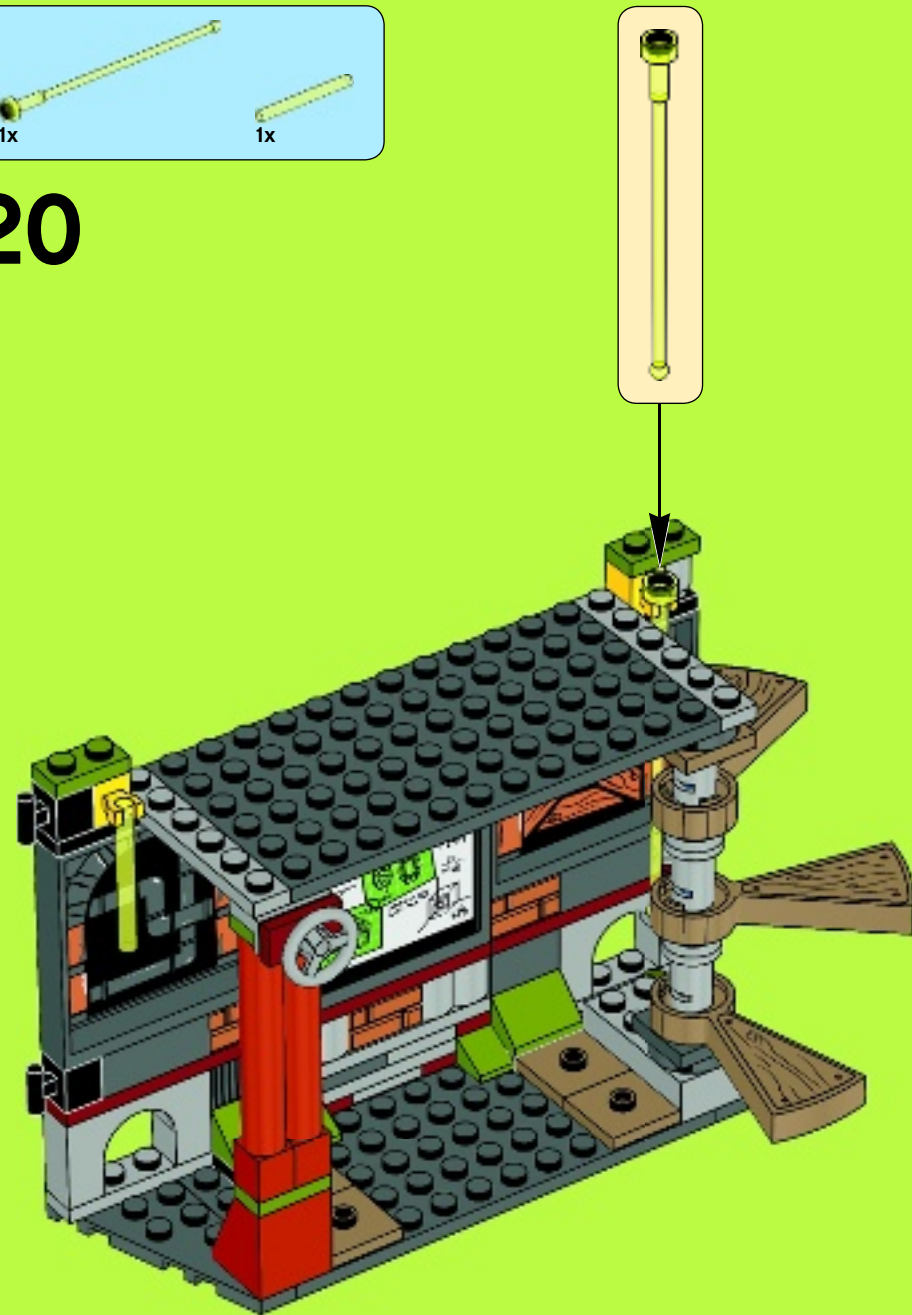

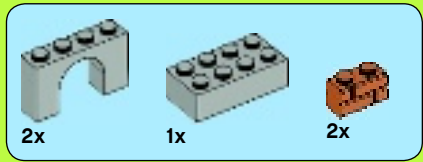
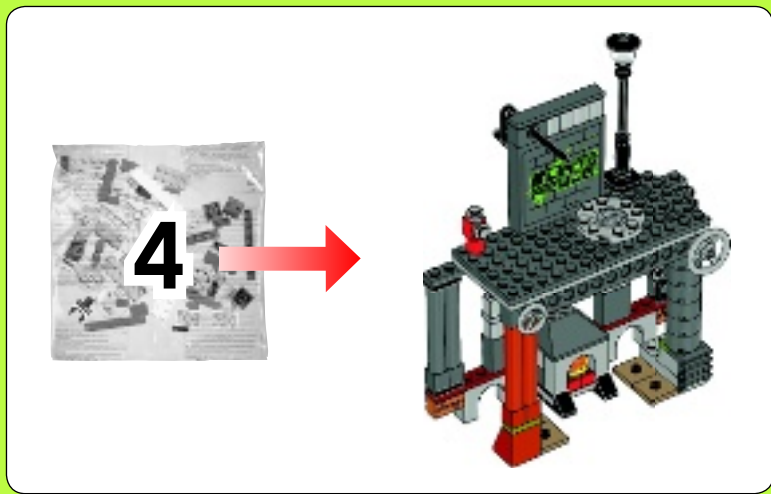

21

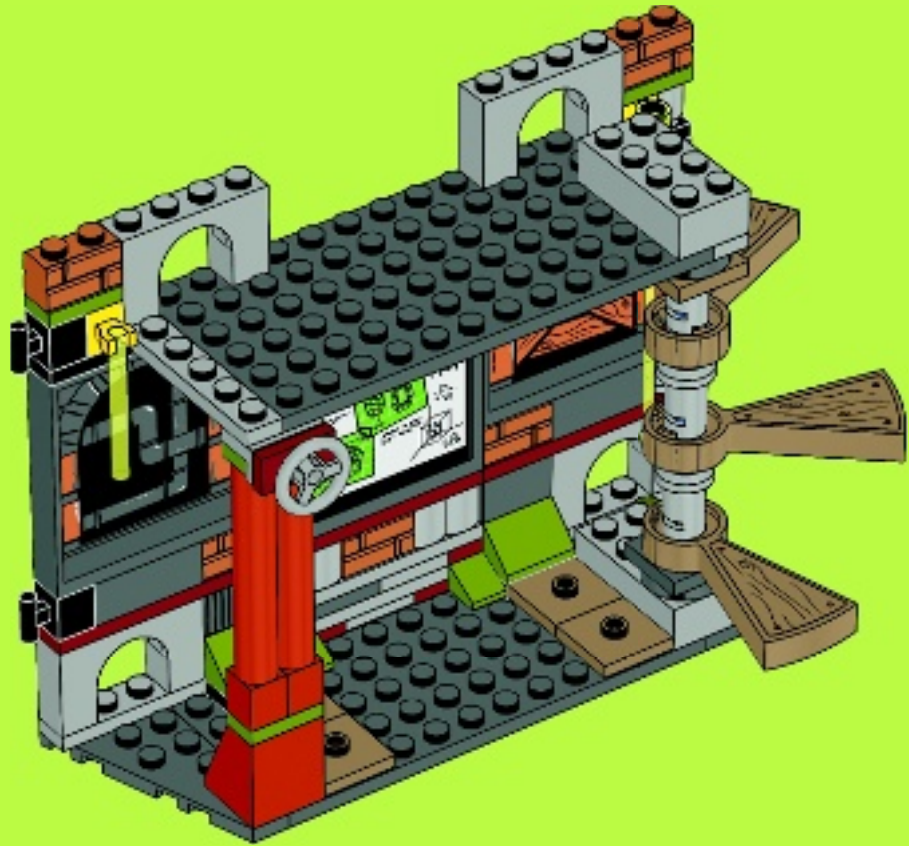



# 22

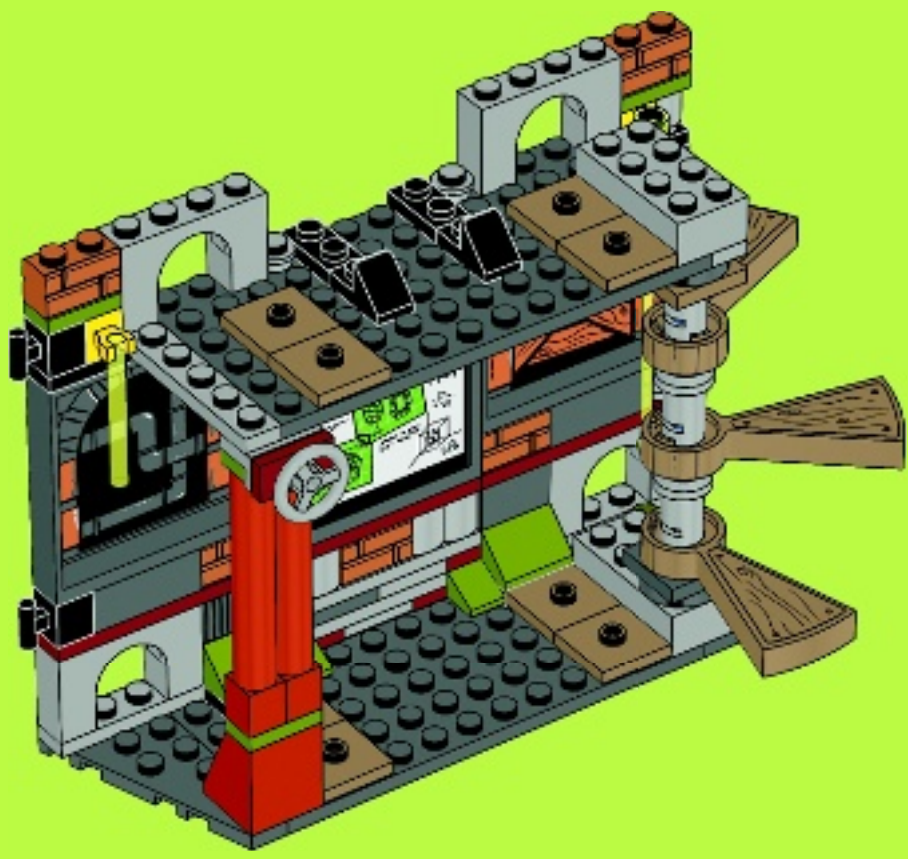





1x



1x

# 23

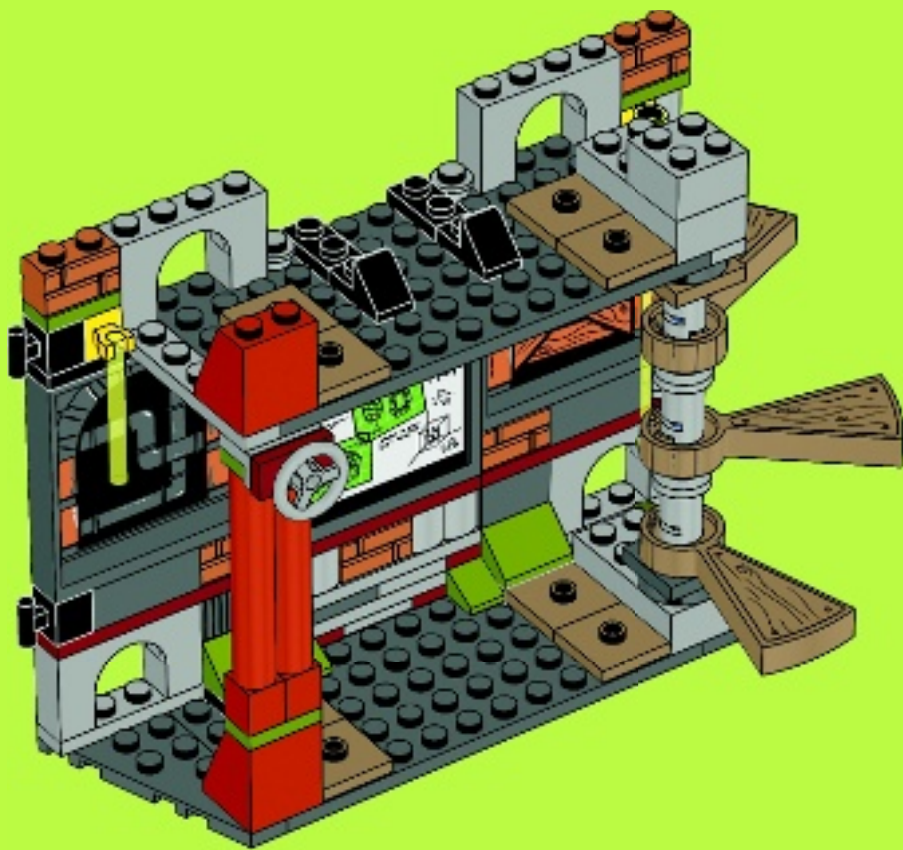

2x



1x



2x

# 24

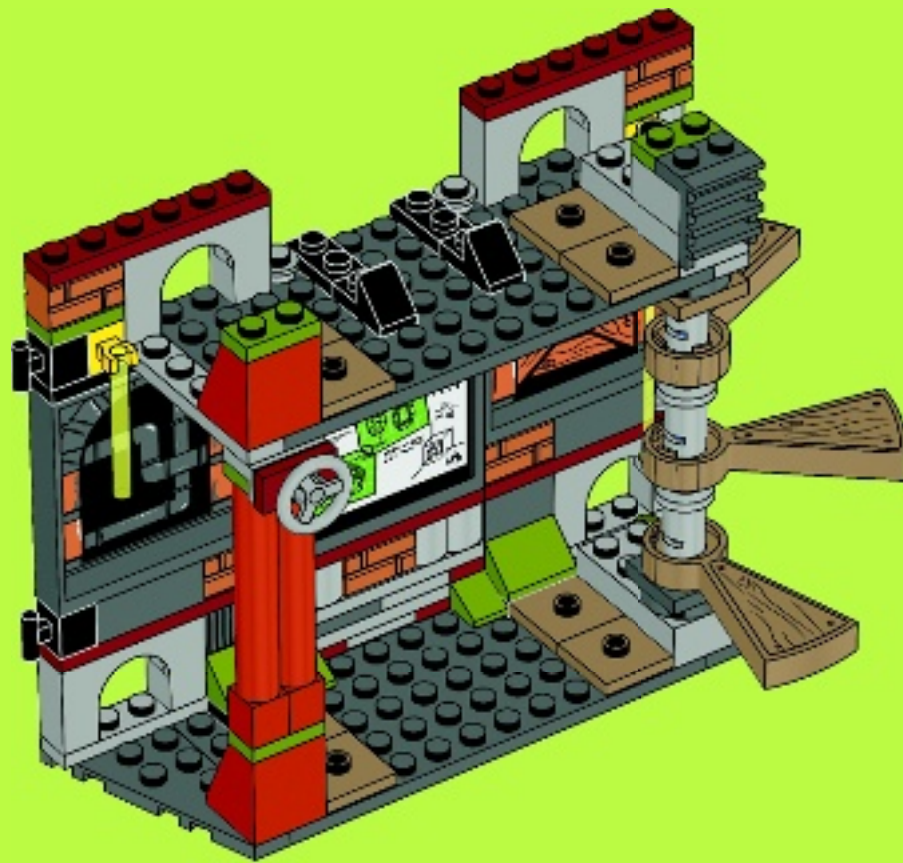



1



2

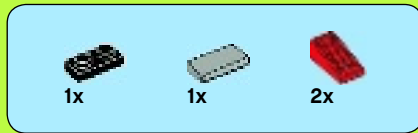

3

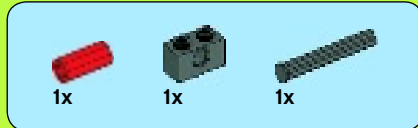

4

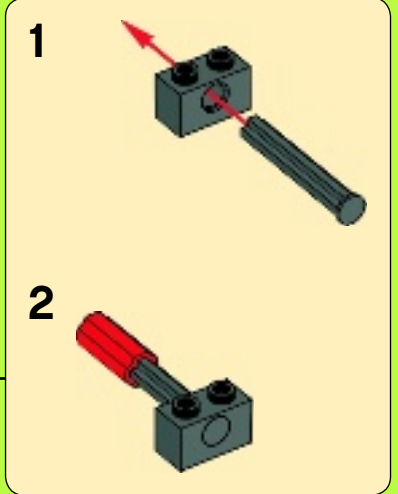
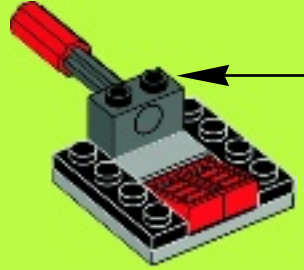



2x

5

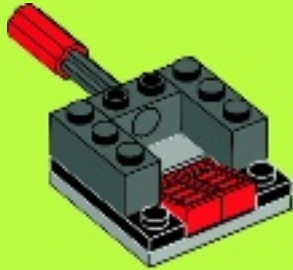

2x

6



2x

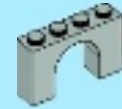

1x

7

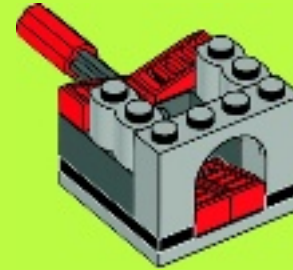

1x

8

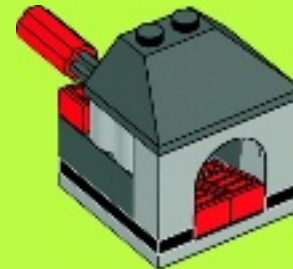



2x

9

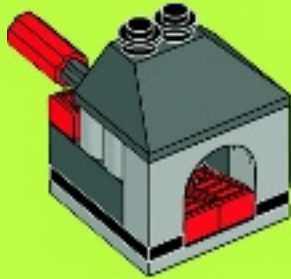

2x

10



1x



1x

11

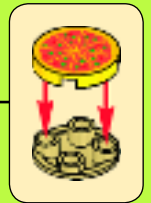

12

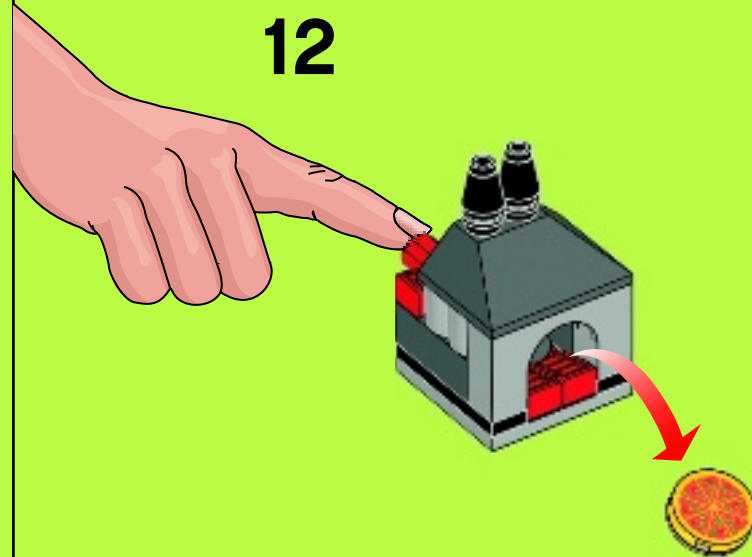



25

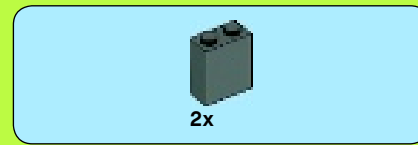
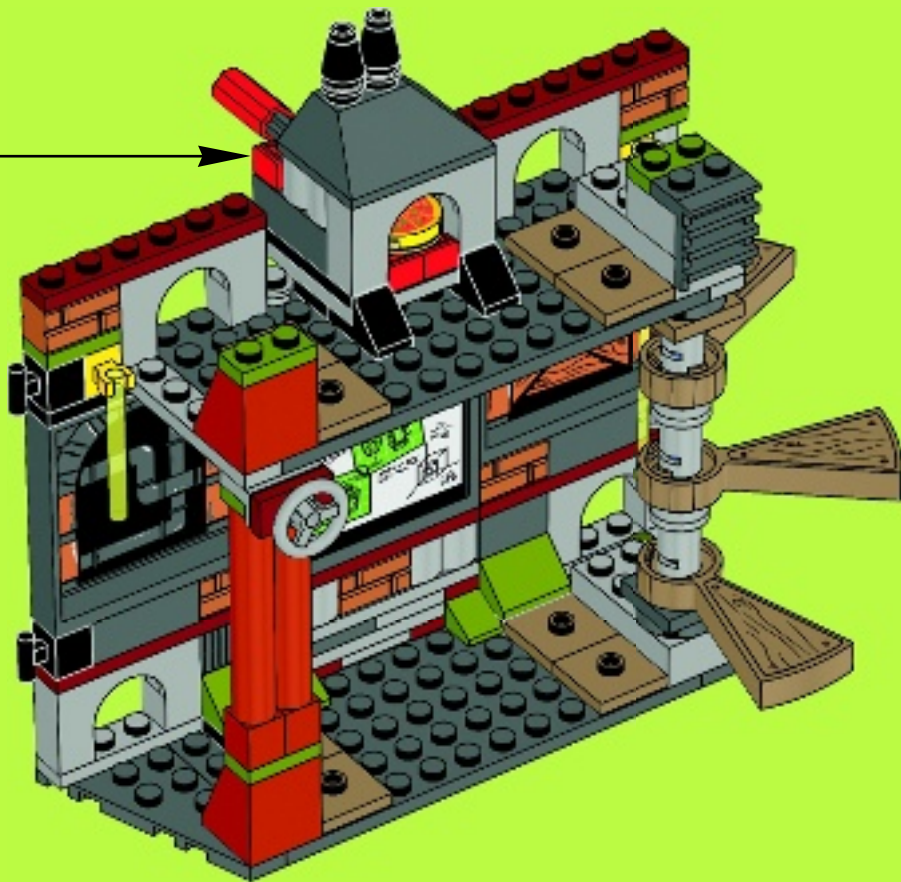

26

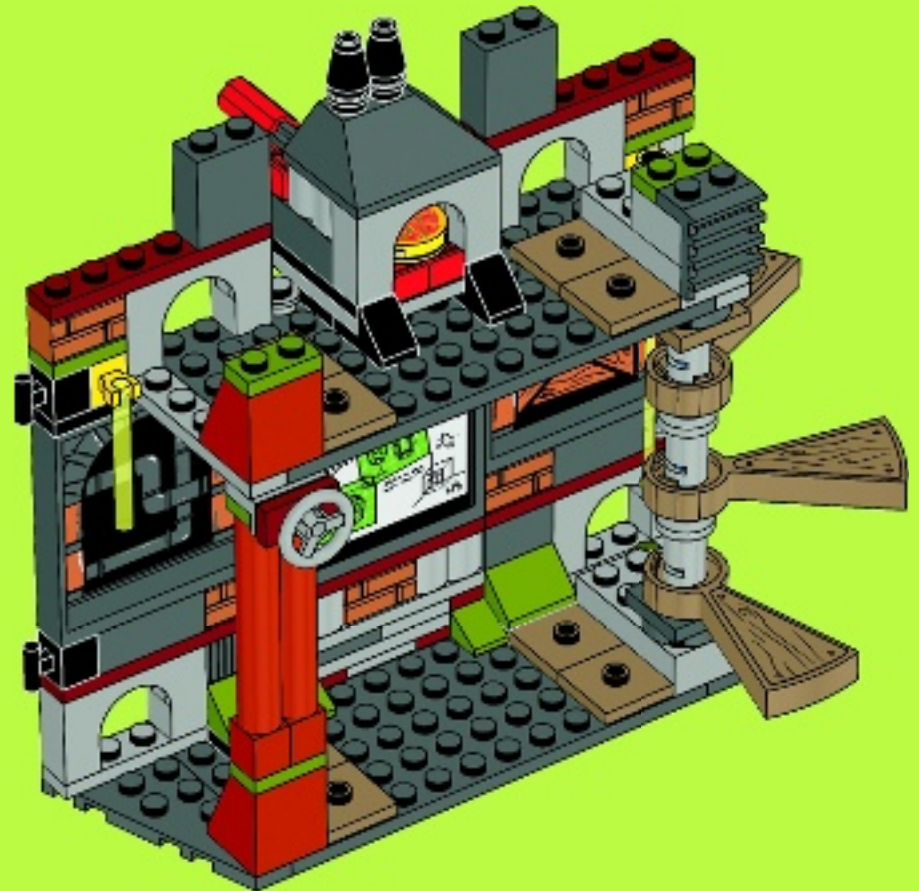

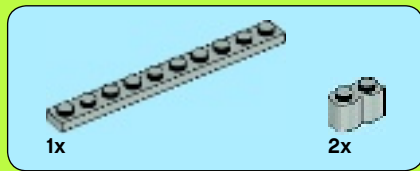

27

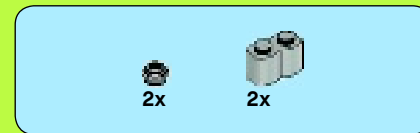
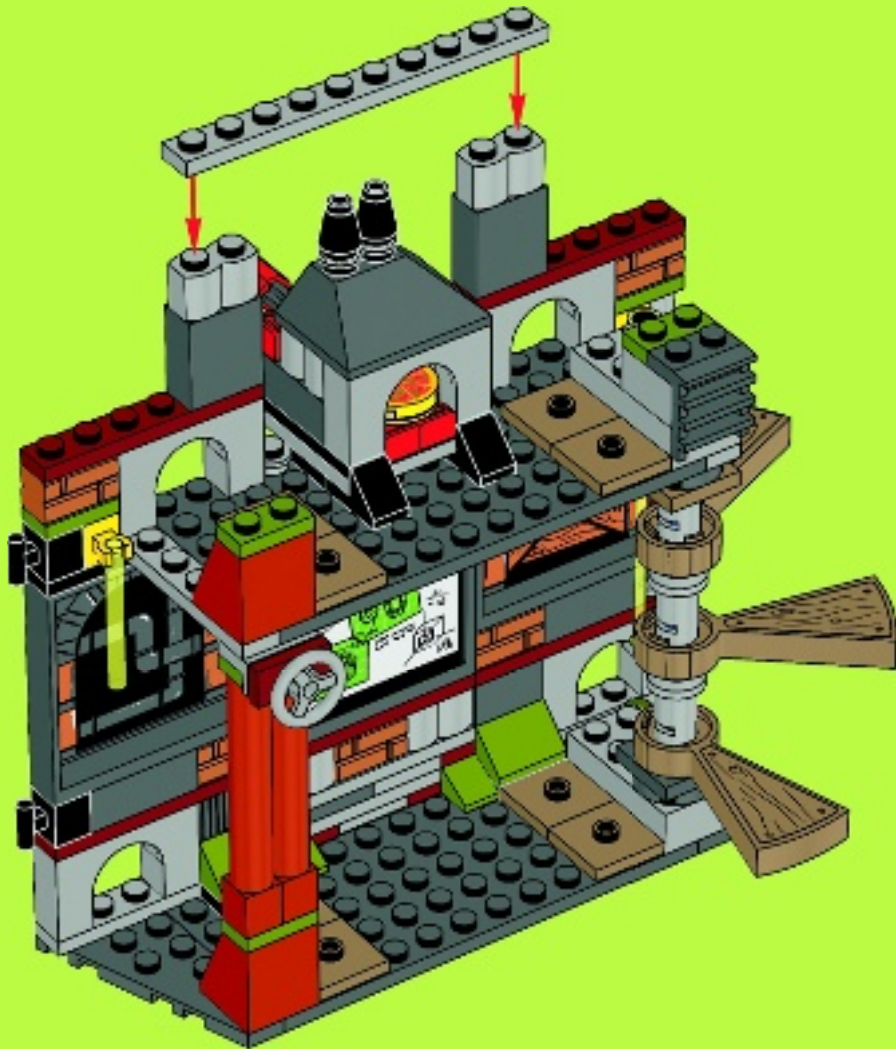

28

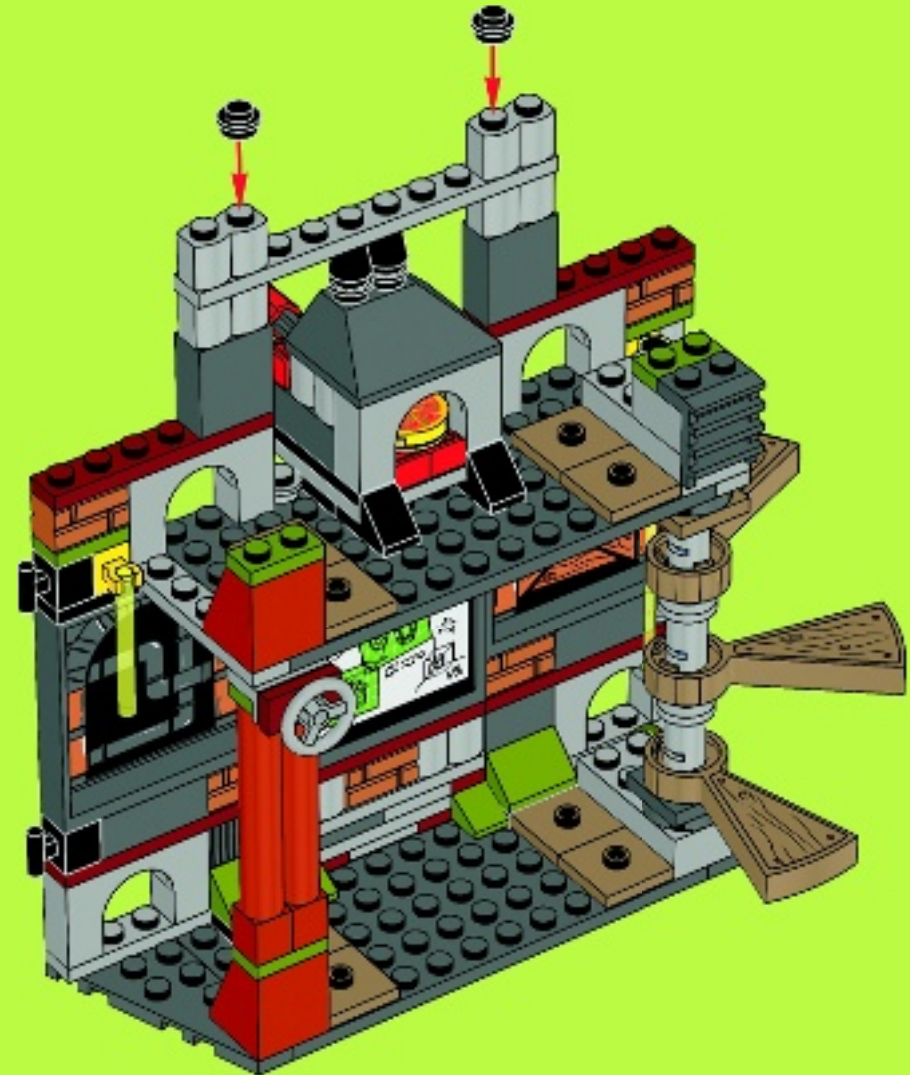



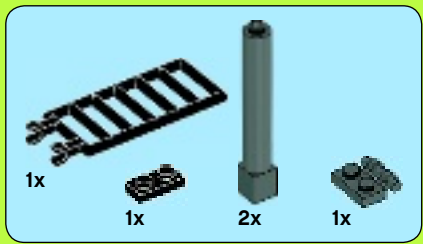

29

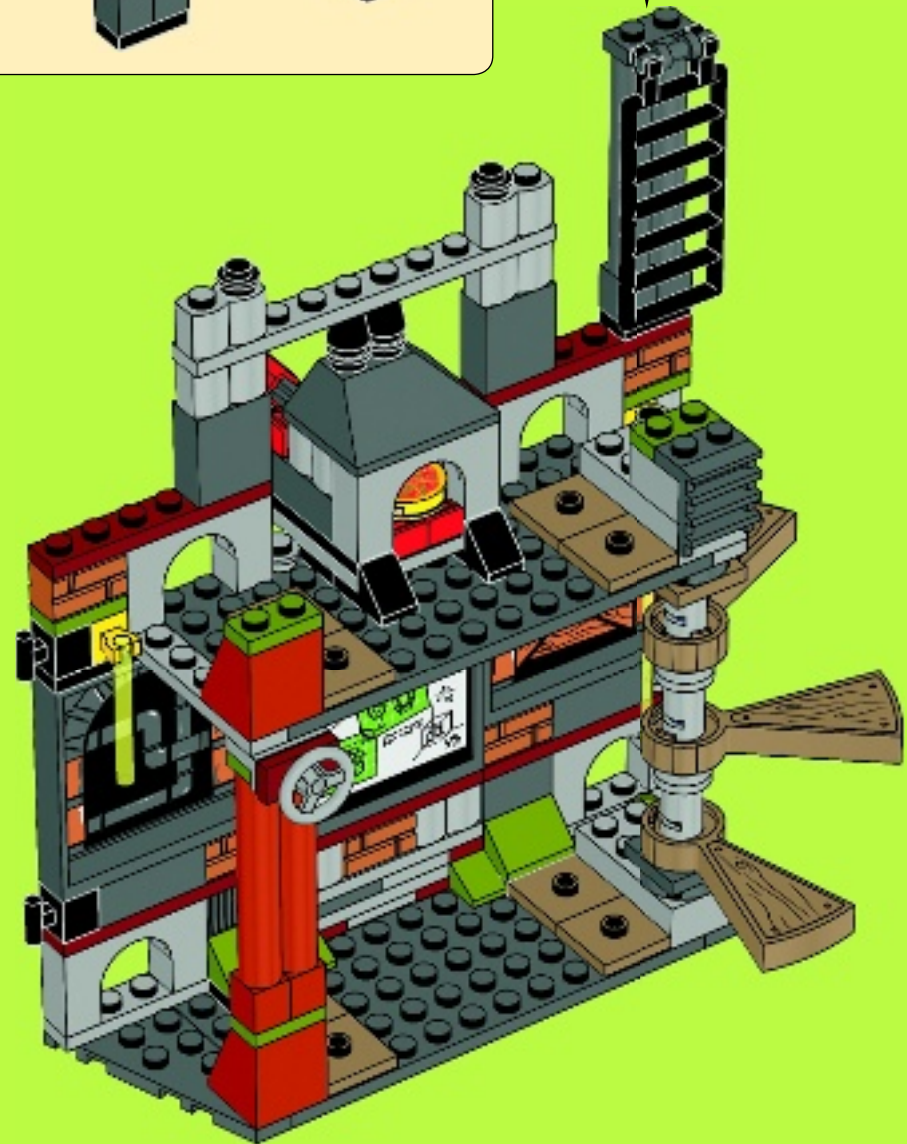
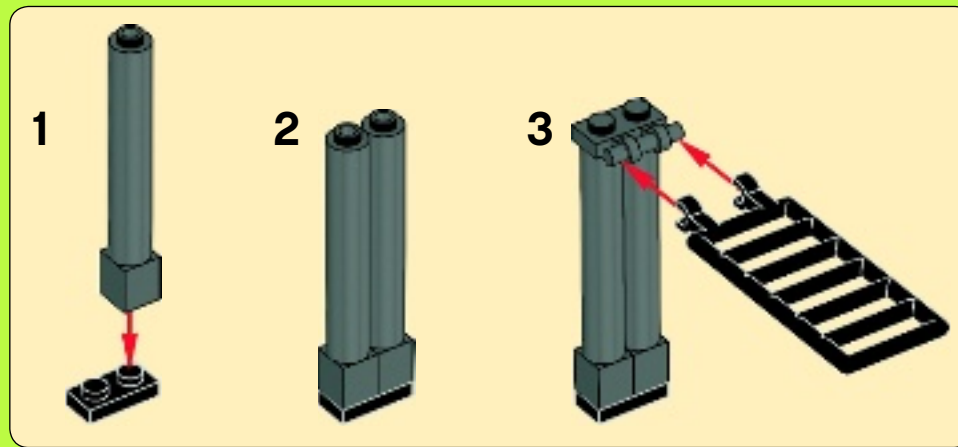

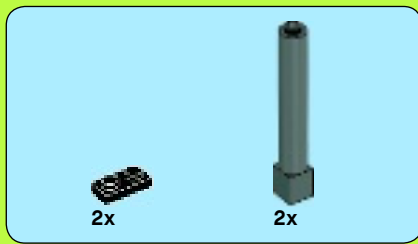

# 30

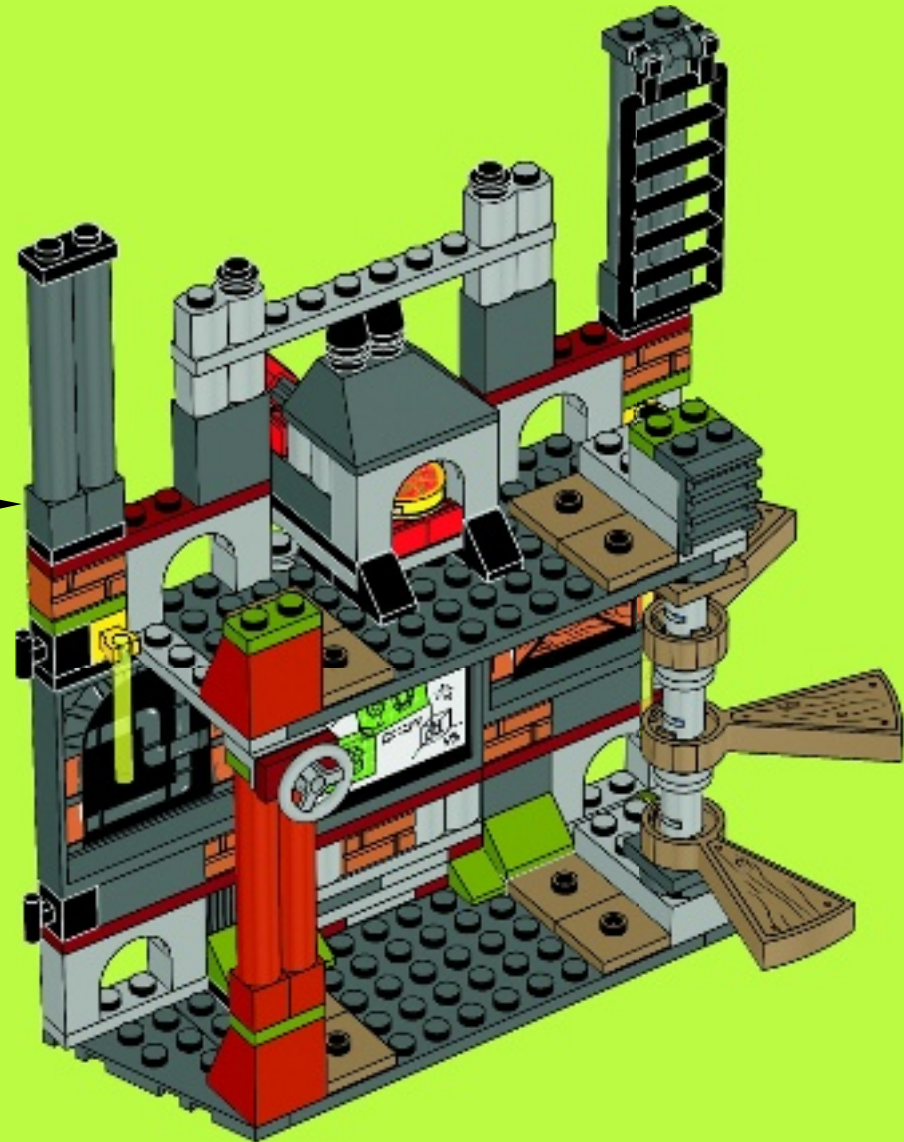
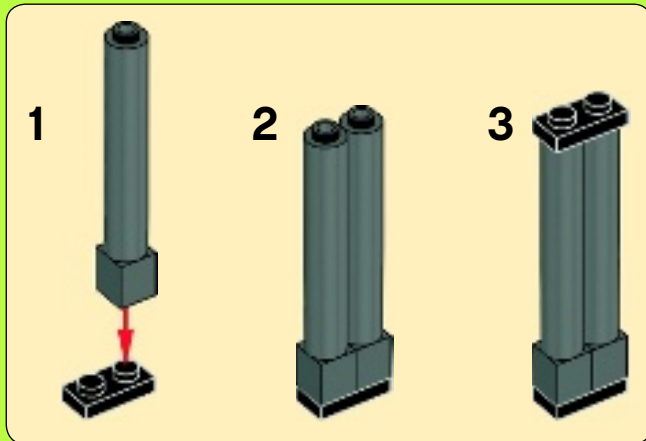



1x



6x

# 31

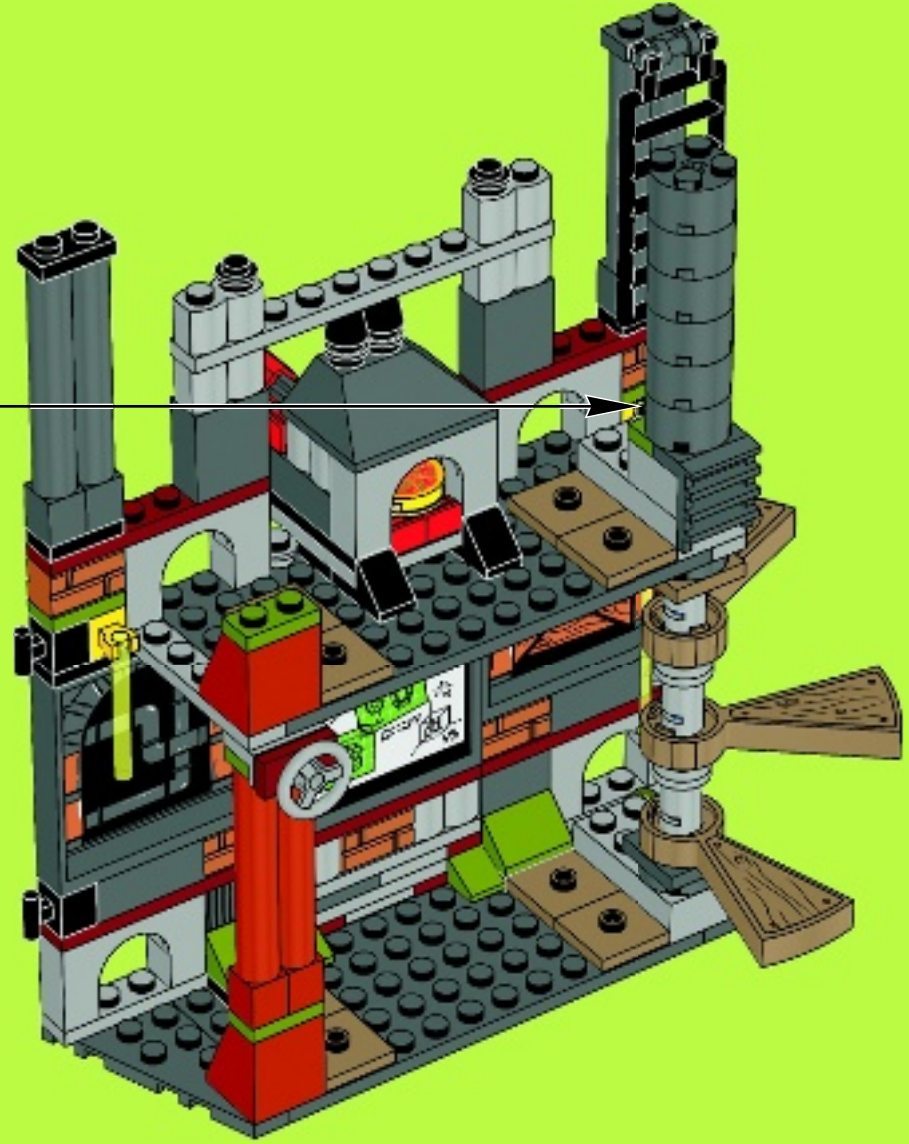
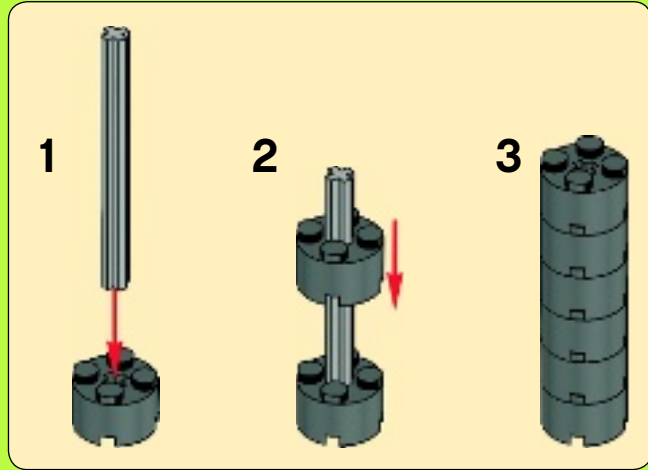



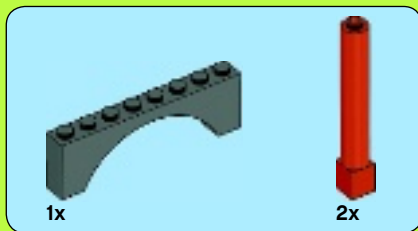

32

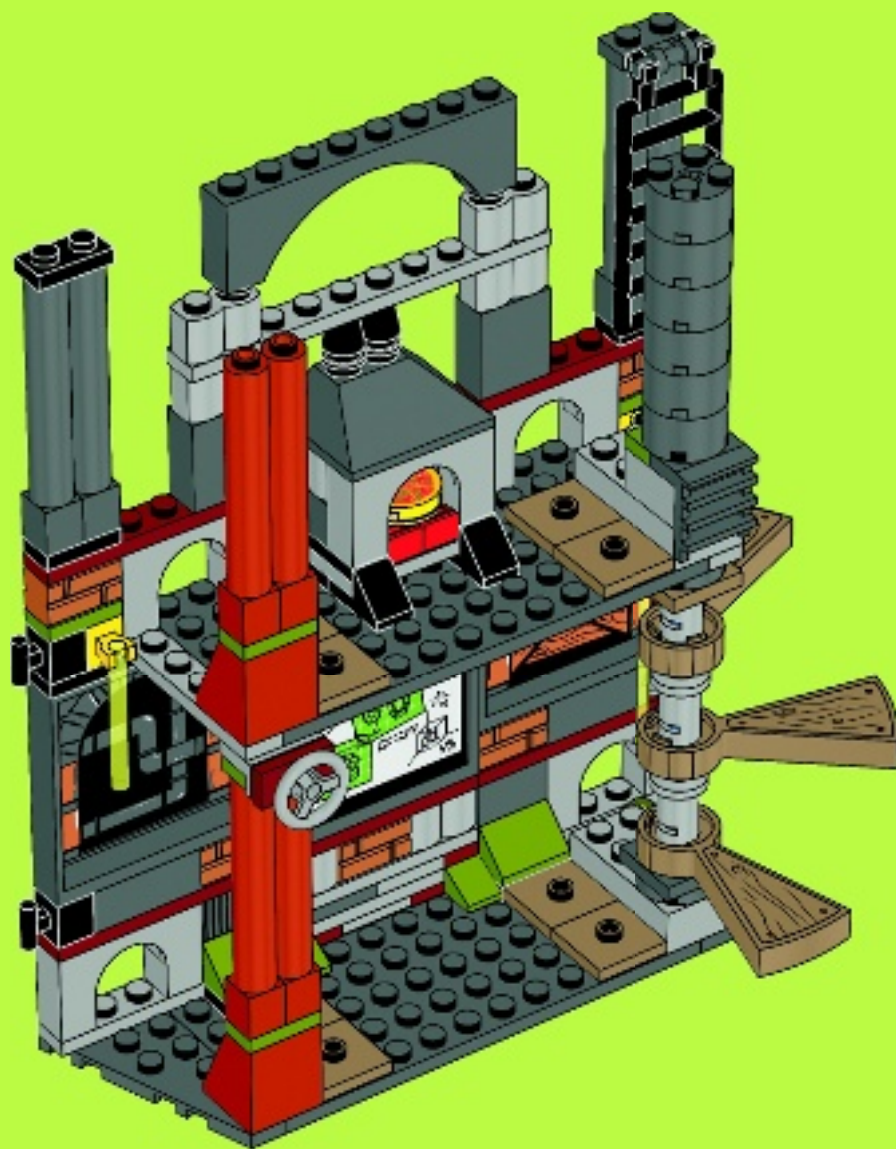

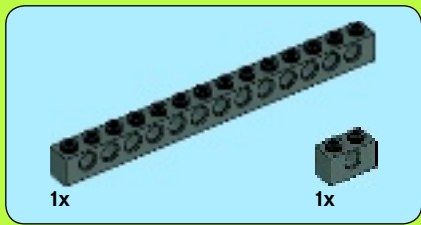

33

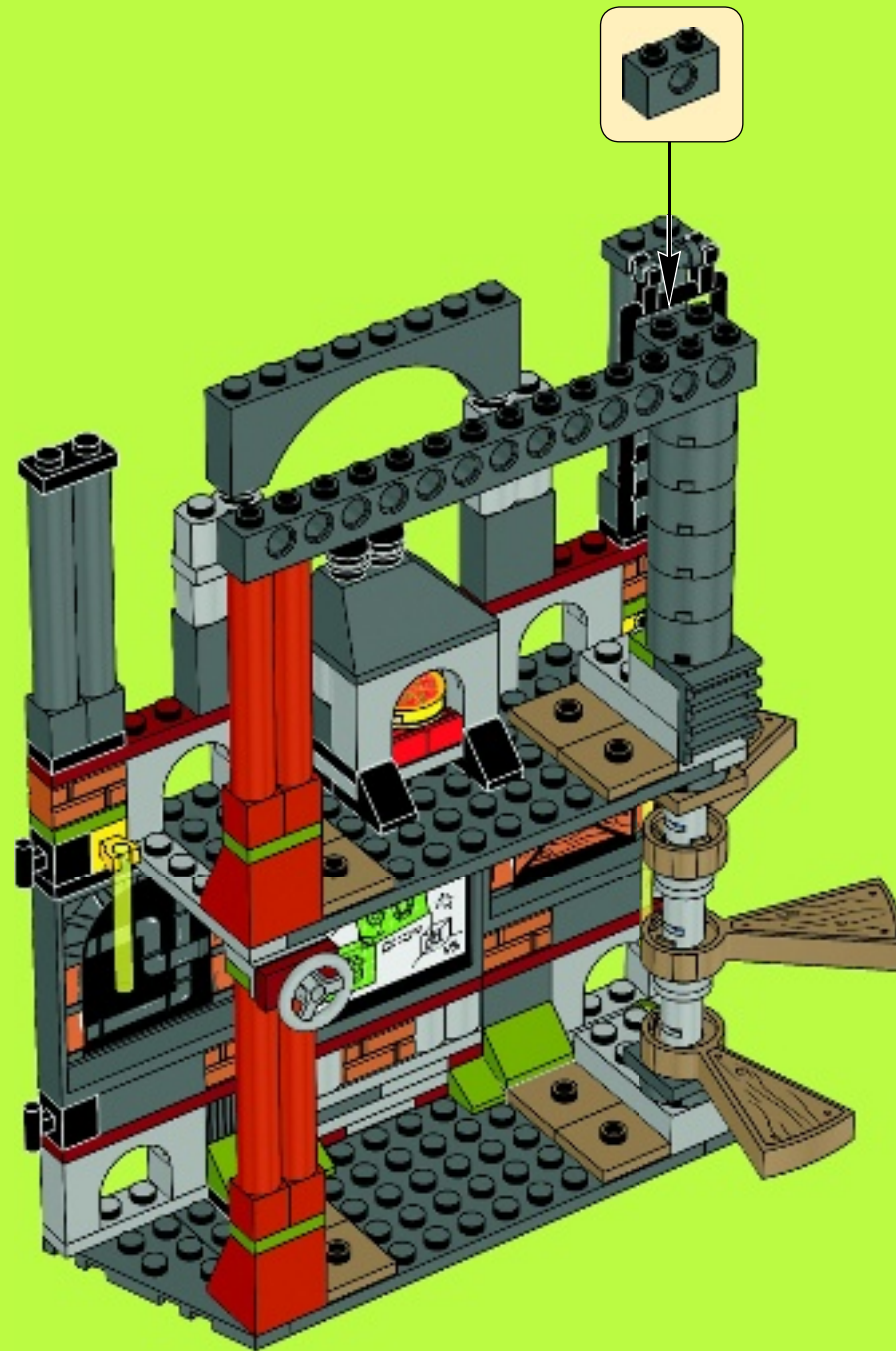





34

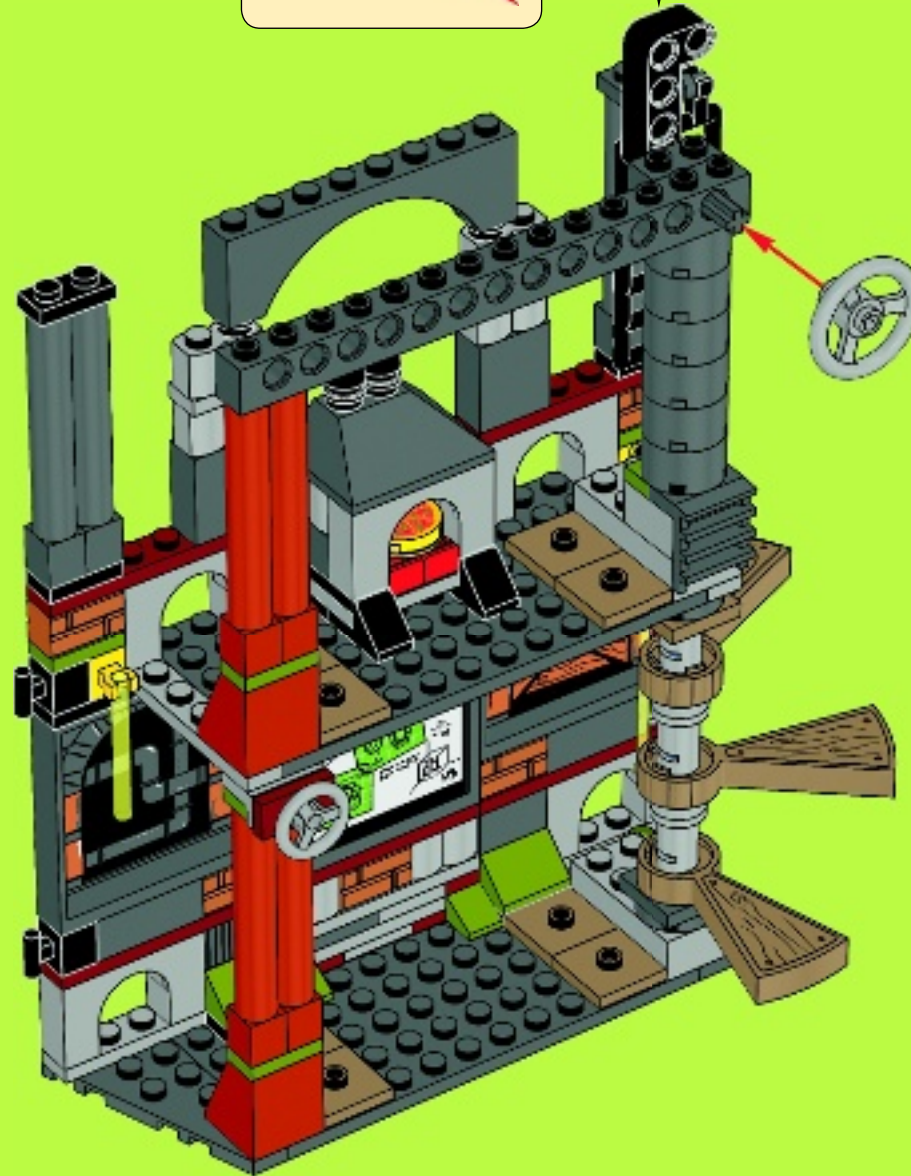
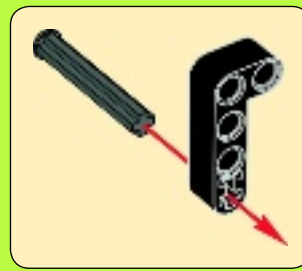

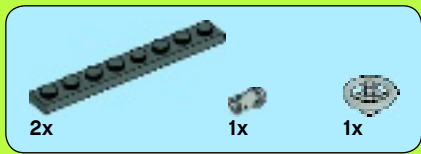

35

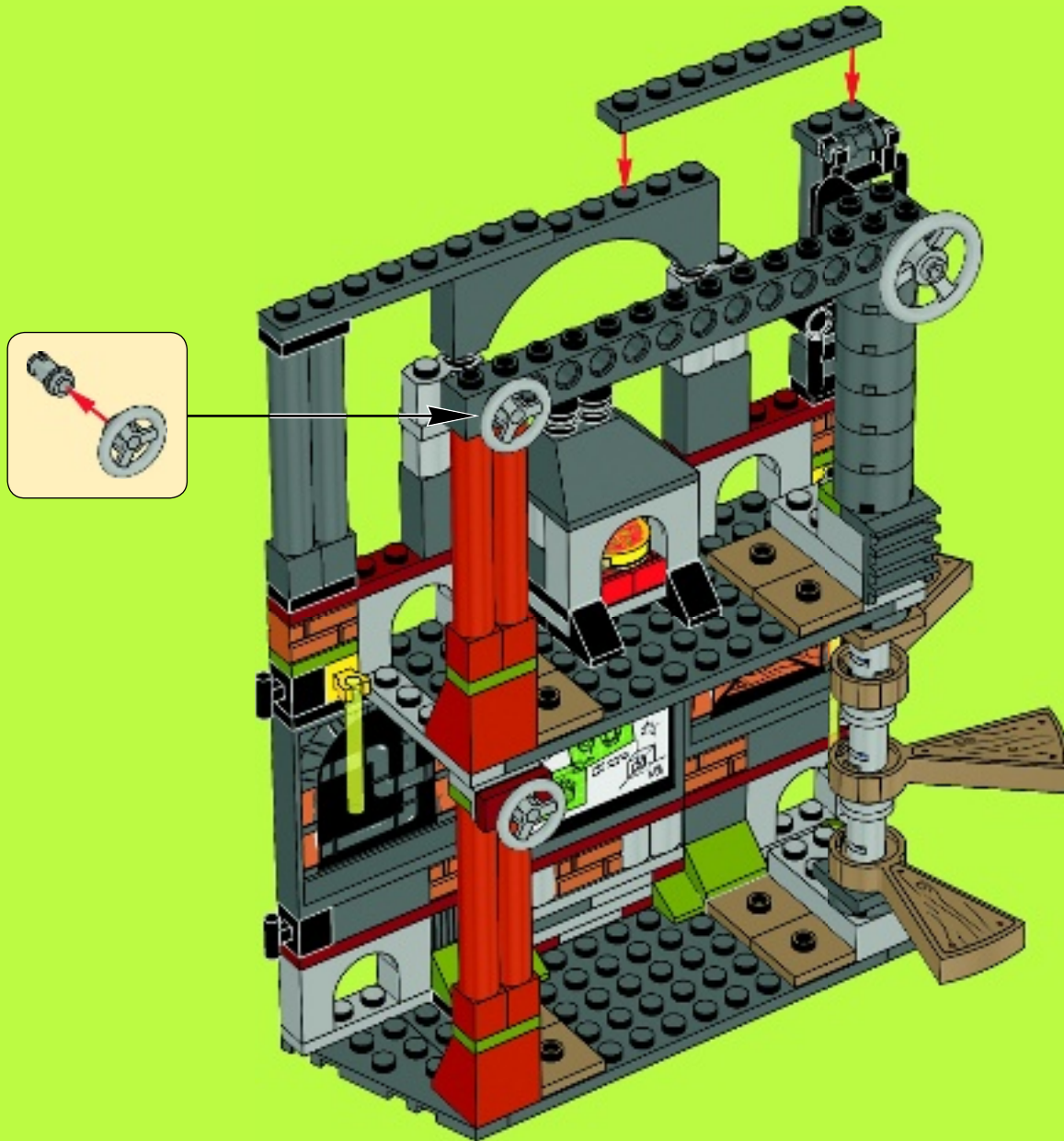

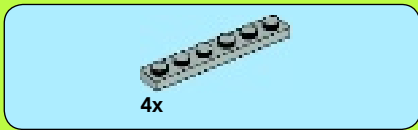

36

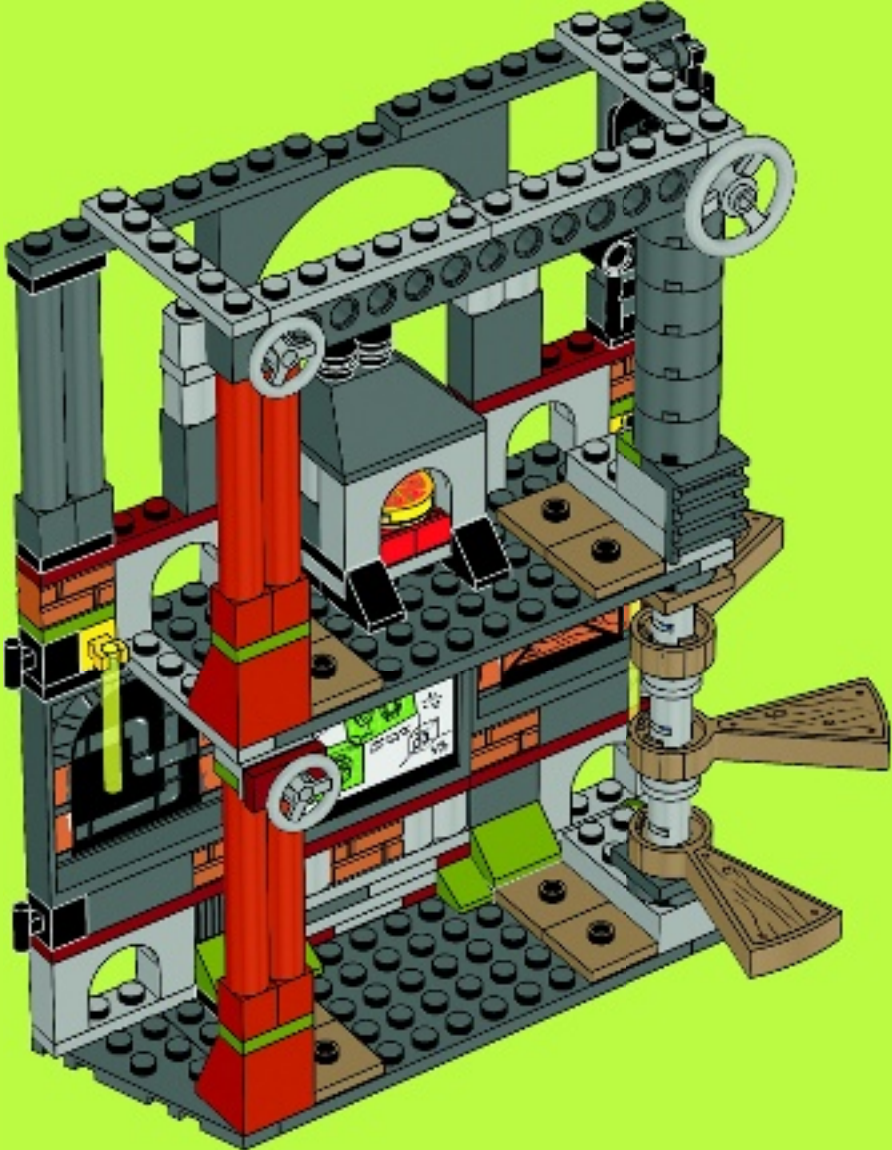



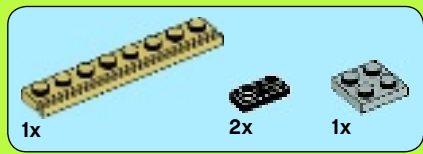

37

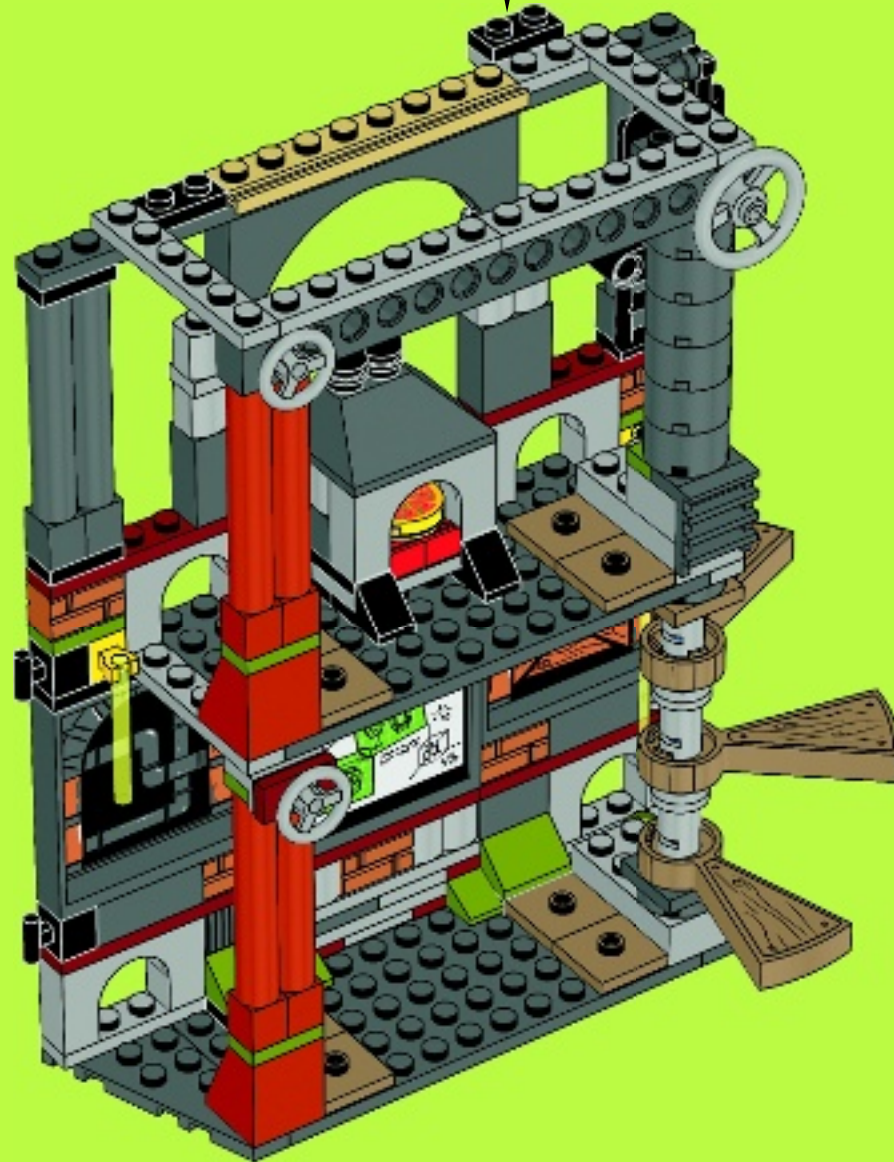
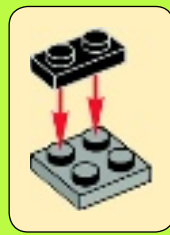

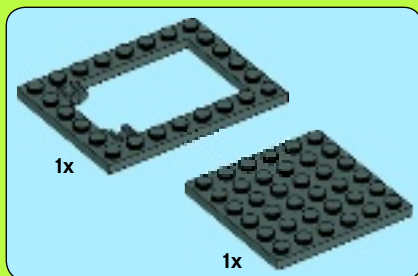

38

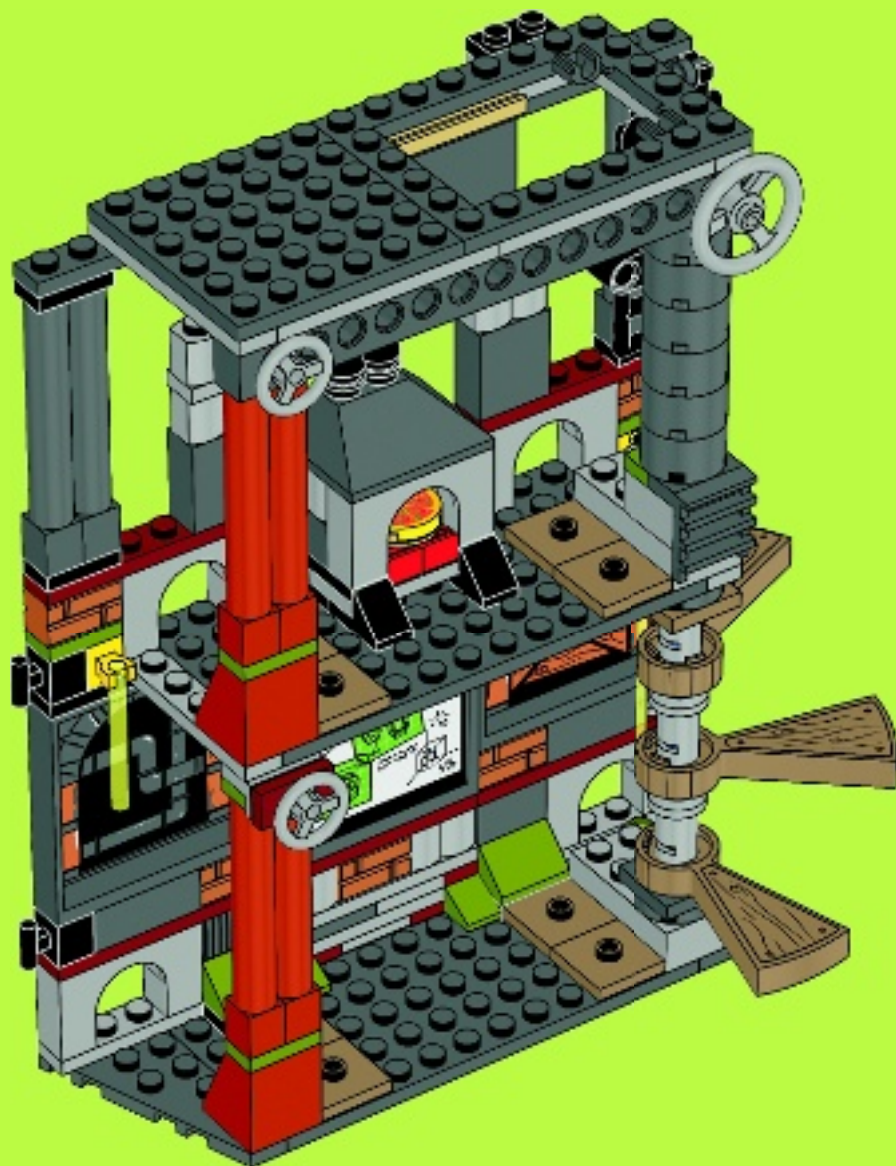

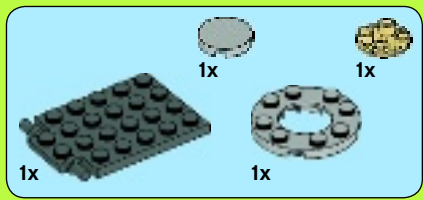

39

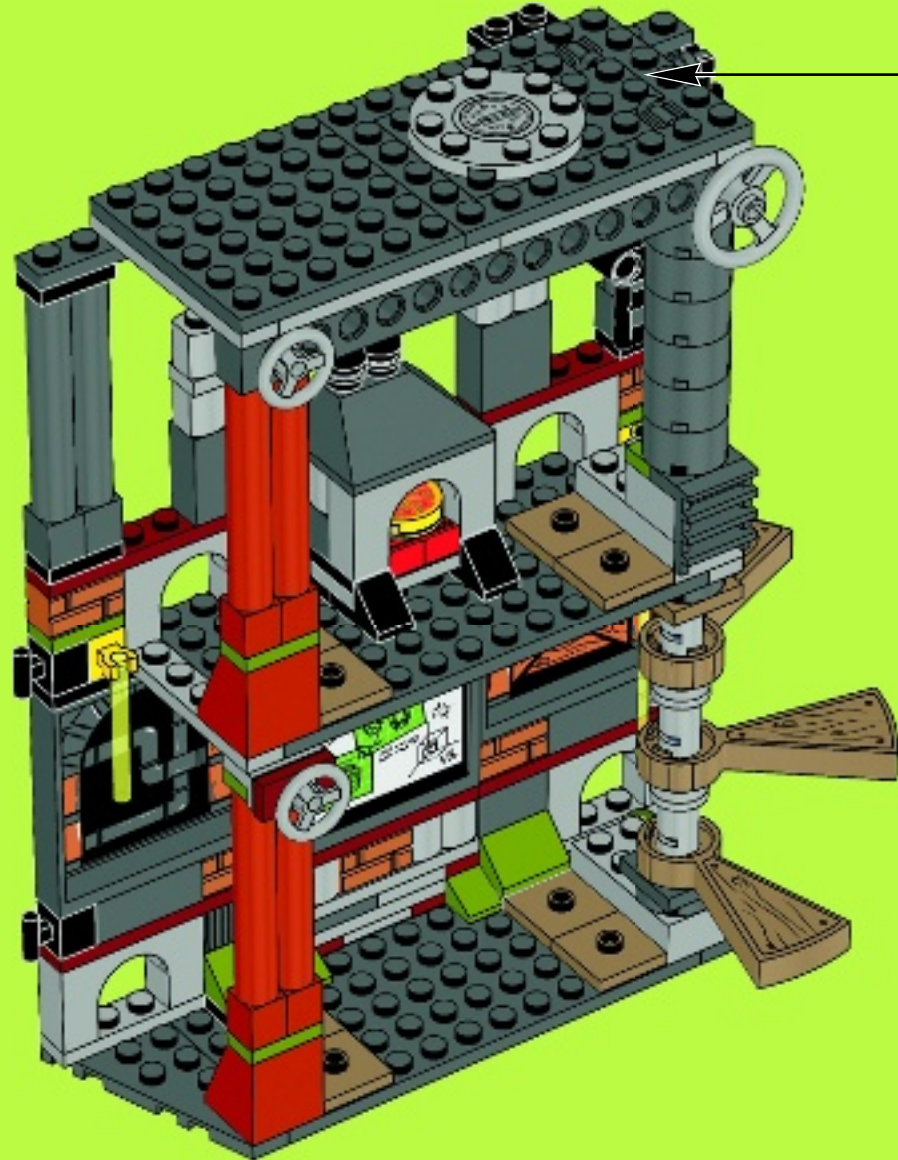
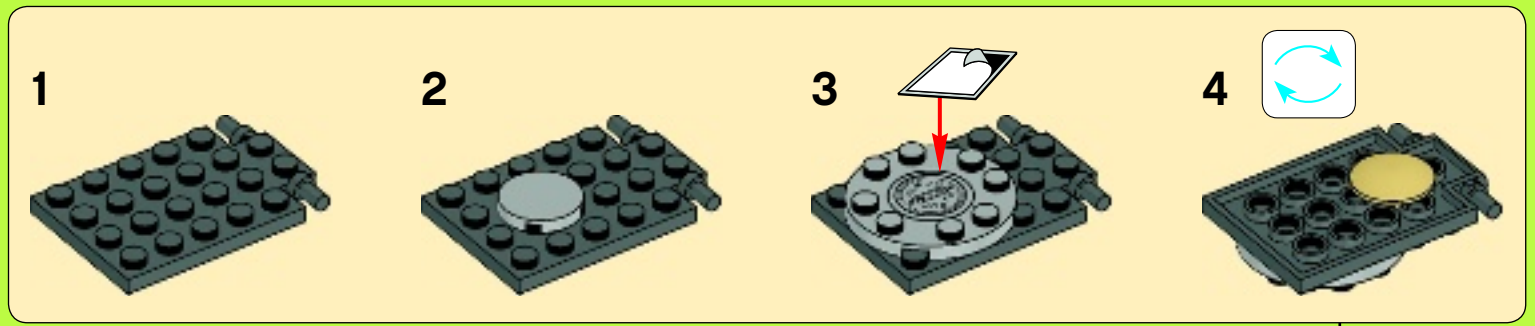





40

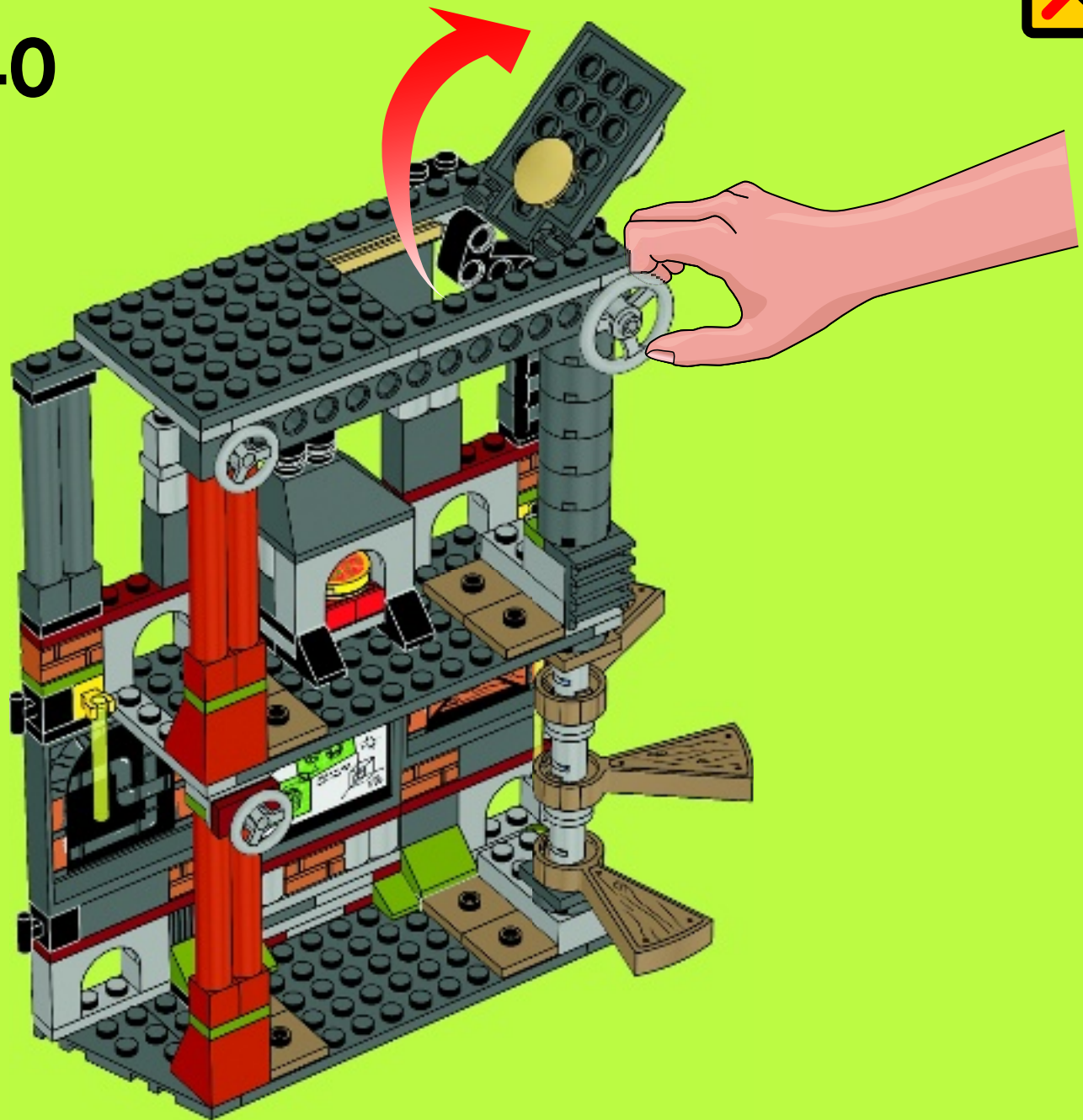



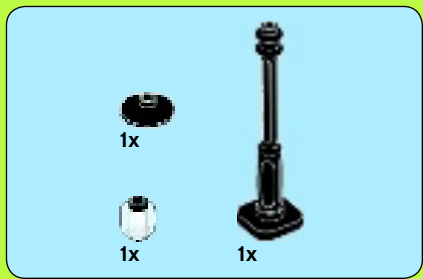

41

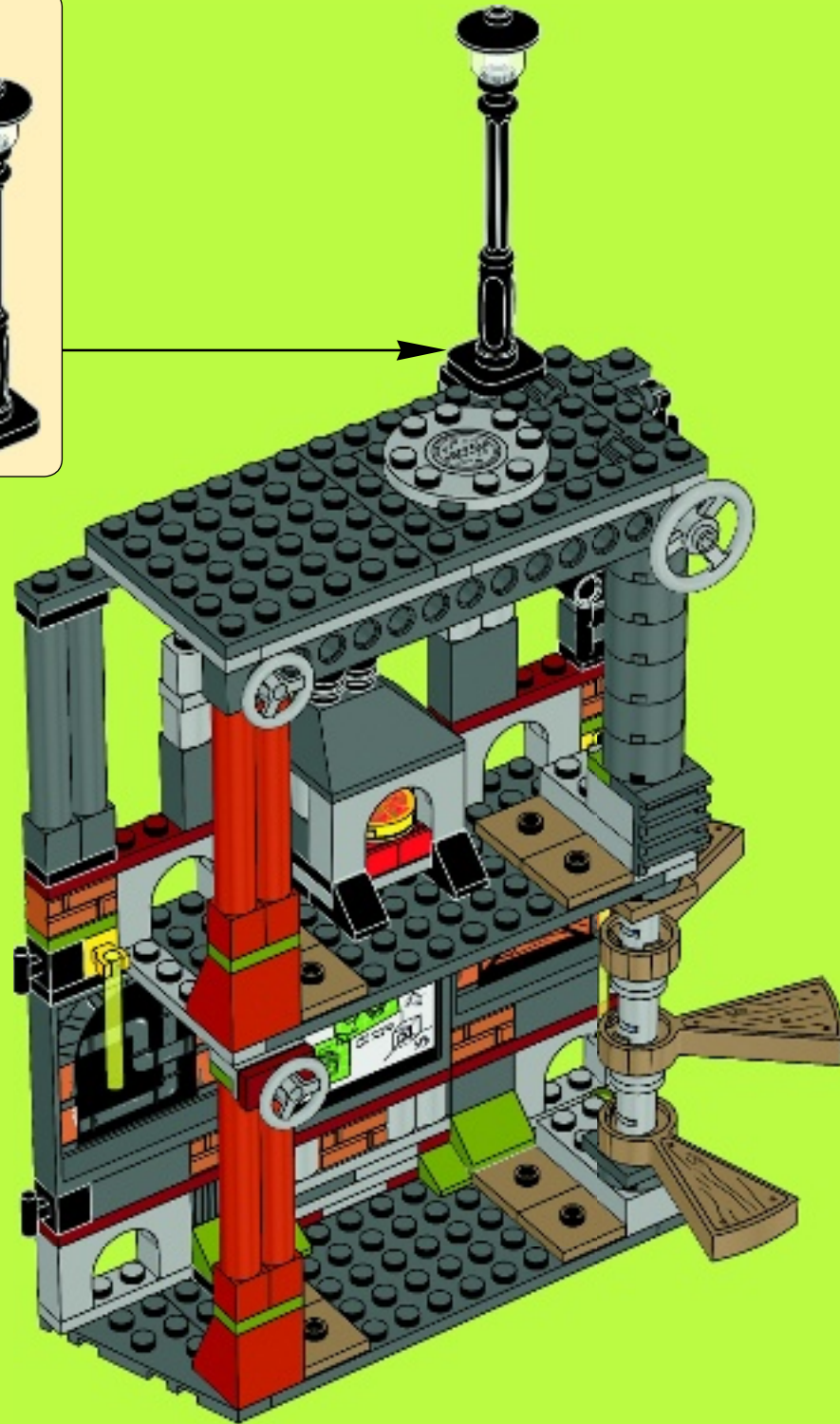
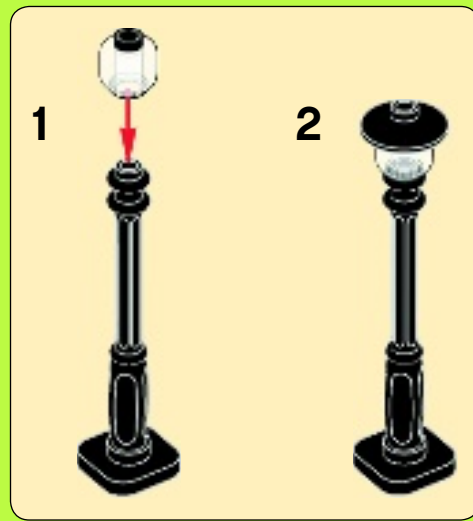

1x  1x  2x 

42

1  2 

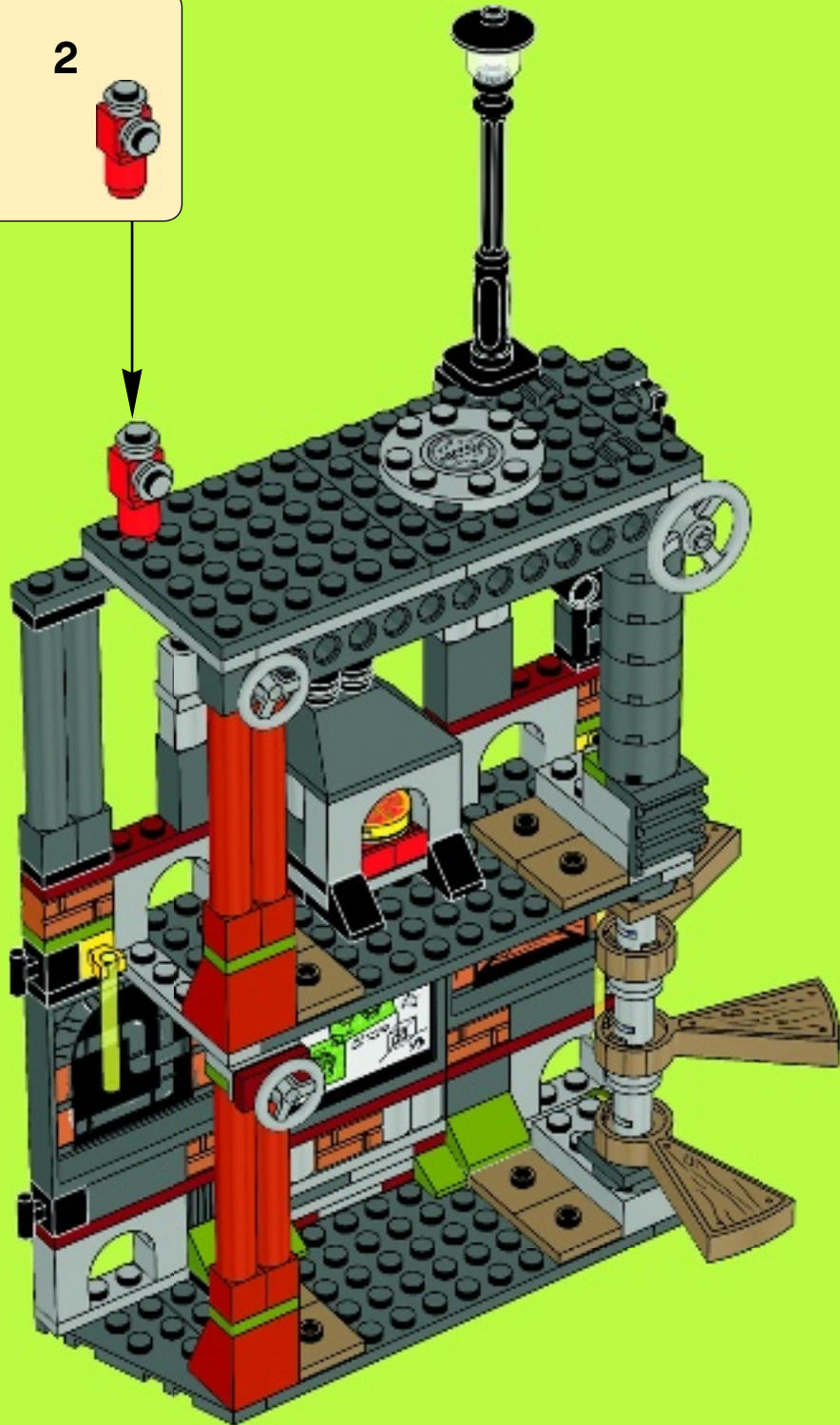

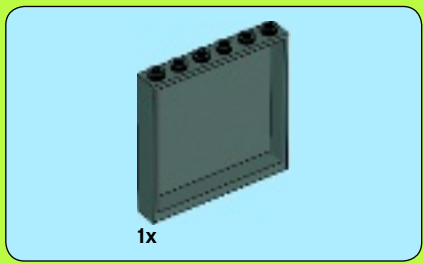

1

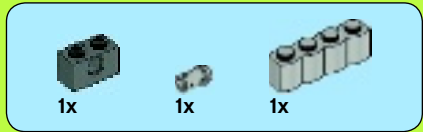

2

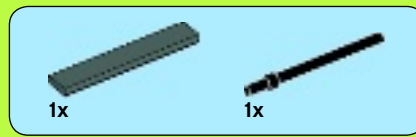
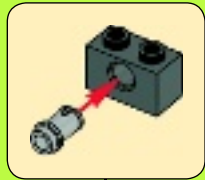

3

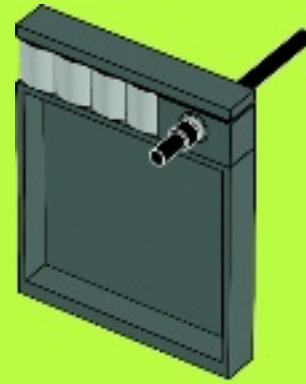

4





5

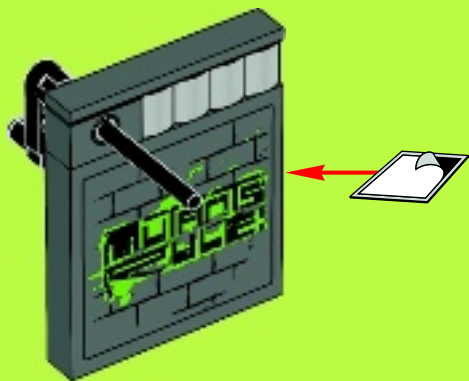

43

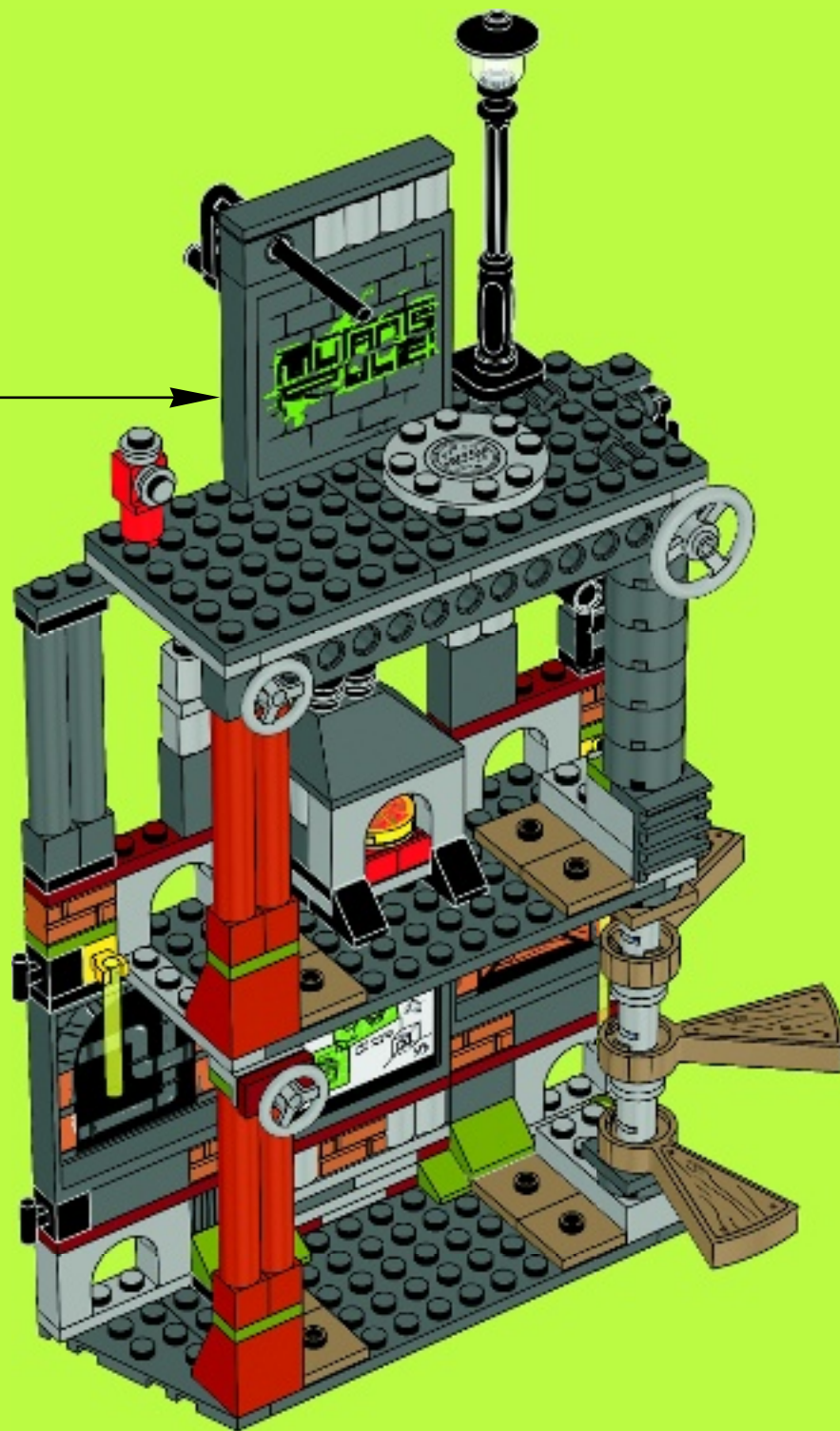

44

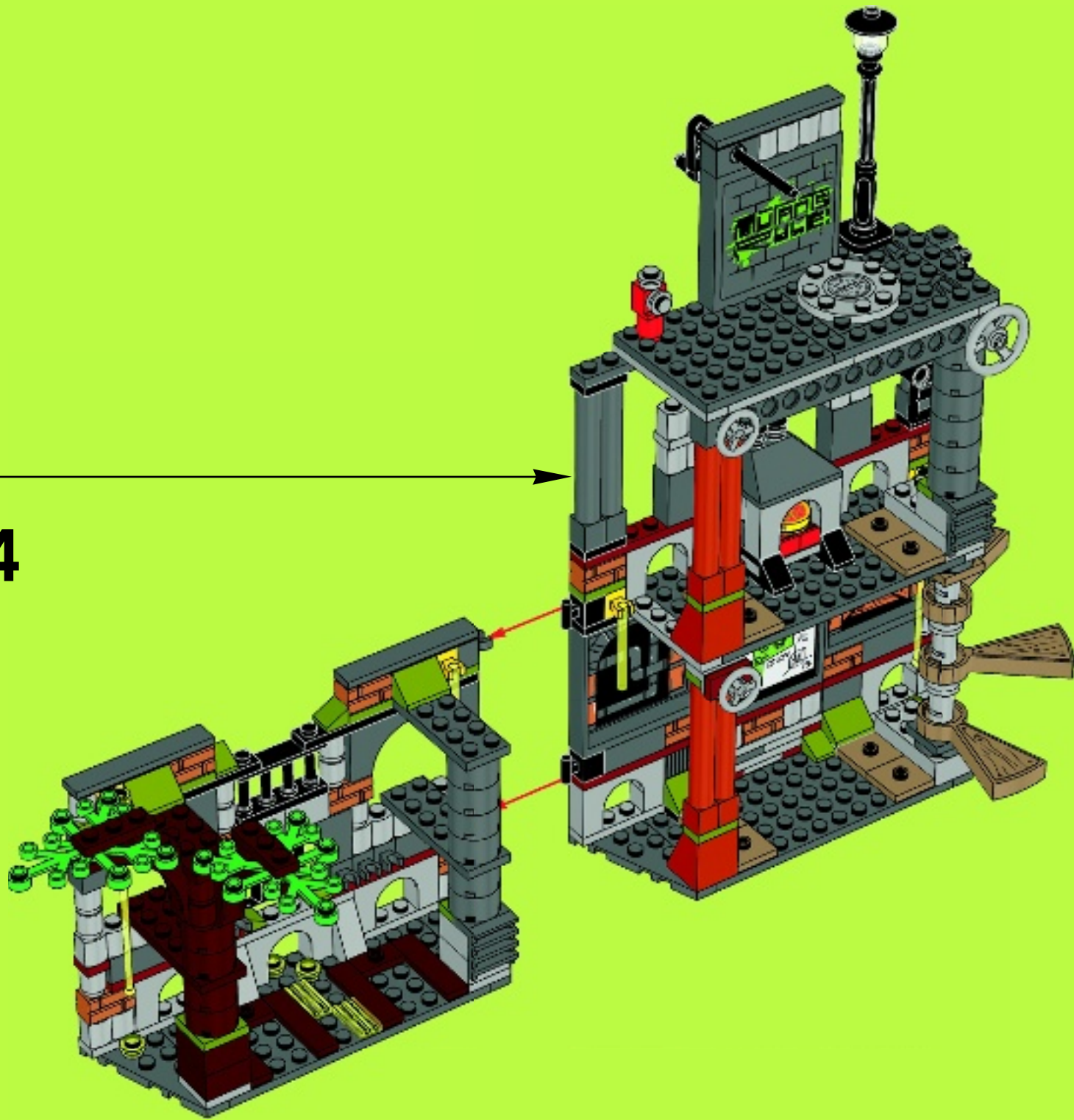







1x  
4195659

2x  
4520636

1x  
4162465

3x  
4570498

1x  
4161443

2x  
4278422

4x  
4642933

2x  
4565452

2x  
292126

2x  
4529236

2x  
4653087

13x  
302326



**Customer Service**  
**Kundenservice**  
**Service Consommateurs**  
**Servicio Al Consumidor**  
**LEGO.com/service or dial**

00800 5346 5555 :

1-800-422-5346 :

4x  
371026

2x  
346026

1x  
4100378

1x  
4144575

6x  
614126

1x  
474026

1x  
4521681

1x  
459926

1x  
4185652

1x  
4282746

1x  
4187209

2x  
73587

1x  
602026

2x  
4140303

1x  
4538722

1x  
9339

1x  
6030249

1x  
6022943

1x  
6030459

2x  
4223247

1x  
452226

2x  
4114206

4x  
249626

1x  
4143372

1x  
6049760

1x  
4159335

1x  
4517986

1x  
6022202

1x  
400626

1x  
4500902

1x  
4120017

1x  
4563044

1x  
4184169

1x  
4177431

1x  
81867

1x  
4621603

1x  
4256320

1x  
4163290

4x  
4515354

1x  
306224

4x  
6030306

2x  
4656509

1x  
4543086

2x  
4210660

2x  
4210978

6x  
4211104

8x  
4580437

1x  
4210636

1x  
4211046

4x  
4180811

15x  
4249139

5x  
4211111

2x  
4603504

1x  
4211137

1x  
6013539

1x  
4508553

3x  
6040252

1x  
4220973

2x  
4211002

2x  
4210998

1x  
4211134

3x  
4256149

1x  
4210848

3x  
6030710

1x  
6000606

1x  
4211129

1x  
4568734

1x  
4225733

3x  
4210651

1x  
4595710

1x  
4595708

2x  
4211042

2x  
4290149

2x  
4290150

1x  
4547222

4x  
4505068

2x  
4560177



 1x 6030534	 1x 300421	 1x 306223	 1x 3005740	 1x 6030431	 2x 4211210	 3x 4526985	 1x 4251149
 1x 6022951	 2x 407021	 1x 403223	 1x 3001140	 4x 4539114	 1x 4216668	 1x 4211805	 1x 4211480
 2x 4579099	 3x 306221	 1x 459923	 2x 4107106	 11x 4539063	 2x 4211225	 3x 4211387	 2x 4211350
 1x 6013297	 2x 4588003	 1x 4172695	 2x 4272661	 8x 4539062	 4x 4211183	 2x 4211385	 3x 4211414
 1x 4600519	 1x 281721	 2x 4514553	 4x 3005749	 1x 6024651	 4x 4211166	 13x 4211385	 1x 6009014
 2x 4623775	 1x 403221	 1x 379428	 2x 4124054	 1x 6024655	 2x 6012805	 2x 4550325	 1x 4654582
 1x 6030236	 1x 459921	 2x 4272665	 2x 256949	 1x 6030581	 4x 4211166	 2x 4211580	 1x 4556157
 11x 4656783	 1x 4619543	 1x 4522673	 9x 4578032	 1x 6008602	 2x 6012805	 3x 4211833	 1x 4261605
 2x 4655241	 1x 4538780	 2x 6025395	 1x 4550329	 1x 6030521	 2x 4219726	 14x 4211412	 4x 4211525
 1x 6030333	 1x 6030305	 1x 6024647	 1x 4541618	 1x 4654448	 2x 4211152	 2x 4515374	 1x 6028015
 3x 4612900	 4x 4540382	 1x 6030247	 3x 6028024	 1x 4221771	 6x 4211186	 8x 6031056	 1x 4640844
 2x 4646867	 1x 4153718	 1x 6030247	 3x 6028024	 1x 4221771	 3x 4243838	 3x 4211397	 2x 4211701
 1x 4612901	 1x 4227155	 1x 6023045	 1x 6023060	 1x 4211218	 2x 4211247	 1x 4211396	 3x 4550251
 12x 6002841	 1x 4142865	 1x 6023045	 1x 6023060	 1x 4211218	 4x 4211194	 1x 4211396	 1x 4580510
 4x 6016474	 1x 4513174	 1x 6023033	 1x 6023062	 2x 4211159	 1x 4538724	 14x 4211438	 2x 4211483
 13x 6016483	 2x 4129872	 2x 6023033	 1x 6031821	 1x 6023052	 1x 4270443	 1x 4243797	 2x 4211758
							 2x 4211807

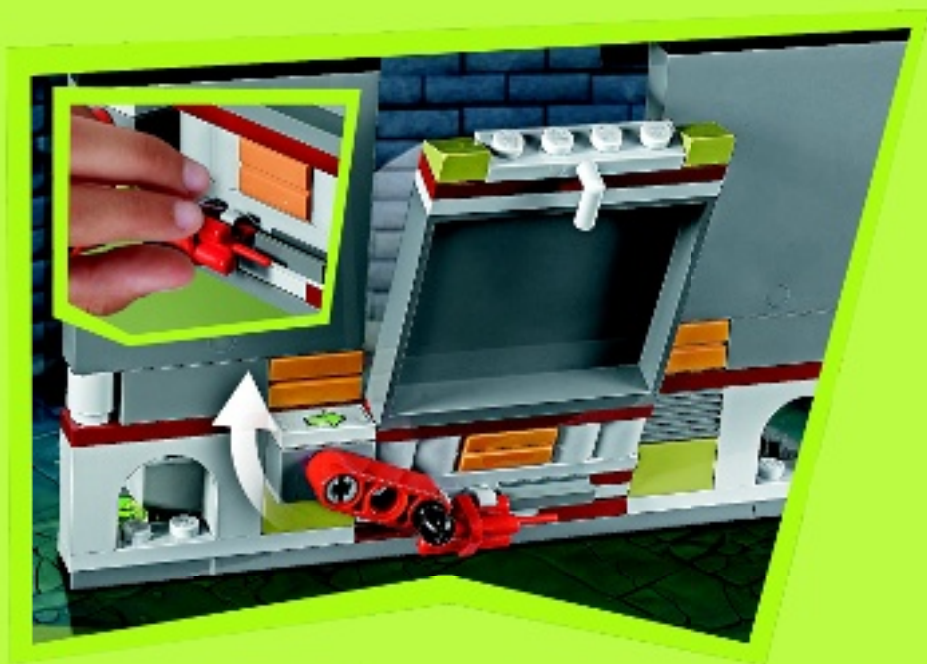







79104



79101



79100



79105



79103



79102







nickelodeon.  
TEENAGE MUTANT NINJA  
**TURTLES**





79100



79100



79100



79101



79101



79101



79102



79102



79102



79103



79103



79103



79103



79103



79104



79104



79104



79104



79104



79105



79105



79105



79105





[www.LEGOclub.com/Max](http://www.LEGOclub.com/Max)

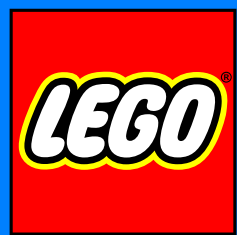

**club**<sup>TM</sup>

**FREE\*! GRATIS! GRATUIT!**

\*Paid subscription in Australia and New Zealand.  
\*Abonnement payant en Australie et Nouvelle-Zélande.







**LEGO.COM/TURTLES**

LEGO and the LEGO logo are trademarks of the LEGO Group. ©2013 The LEGO Group.

6090109

©2013 Viacom Overseas Holdings C.V. All Rights Reserved. Teenage Mutant Ninja Turtles and all related titles, logos and characters are trademarks of Viacom Overseas Holdings C.V.