

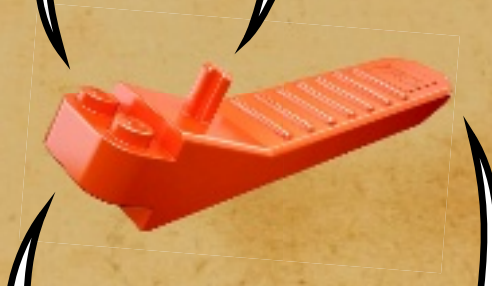

PIRATES

70413





[LEGO.com/brickseparator](http://LEGO.com/brickseparator)



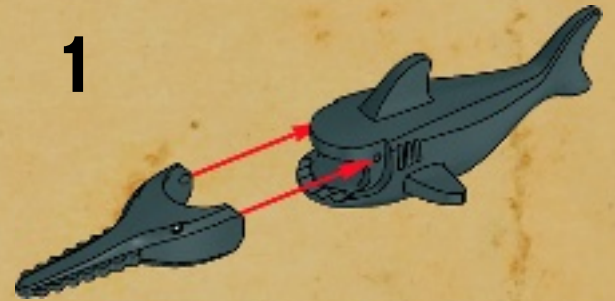
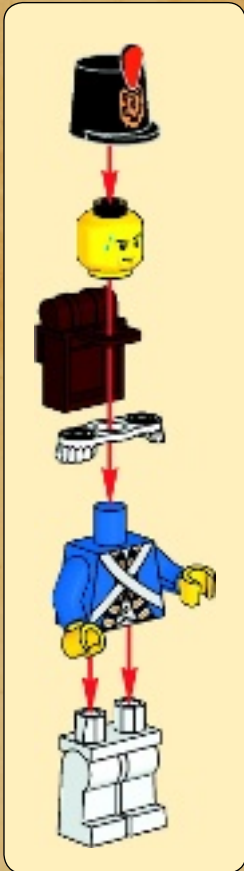



1



2



3

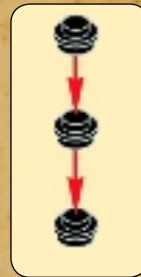



4

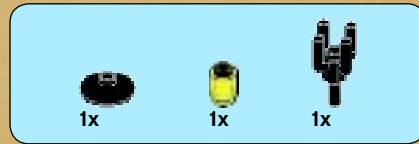
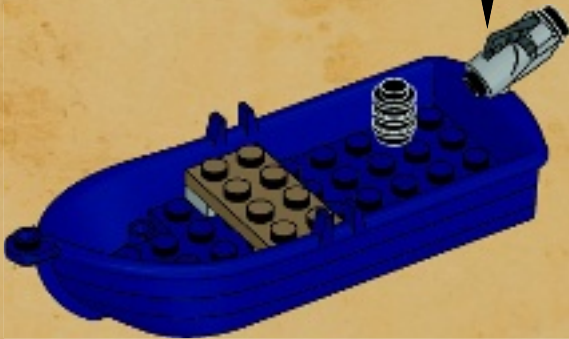
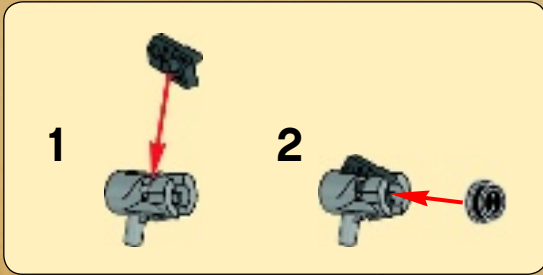

5

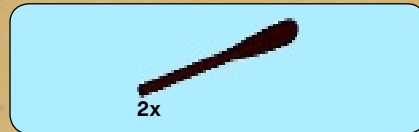
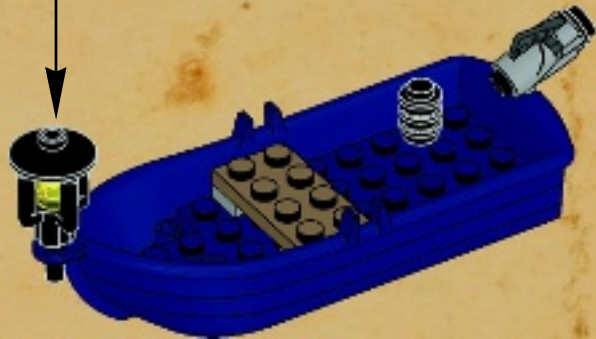
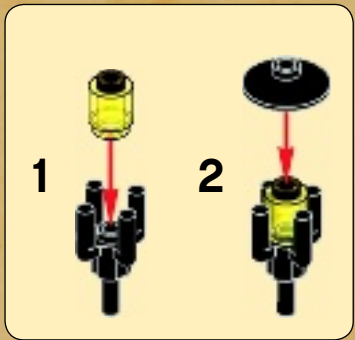

6

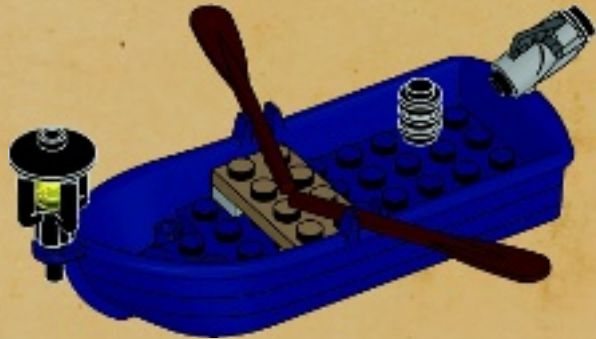

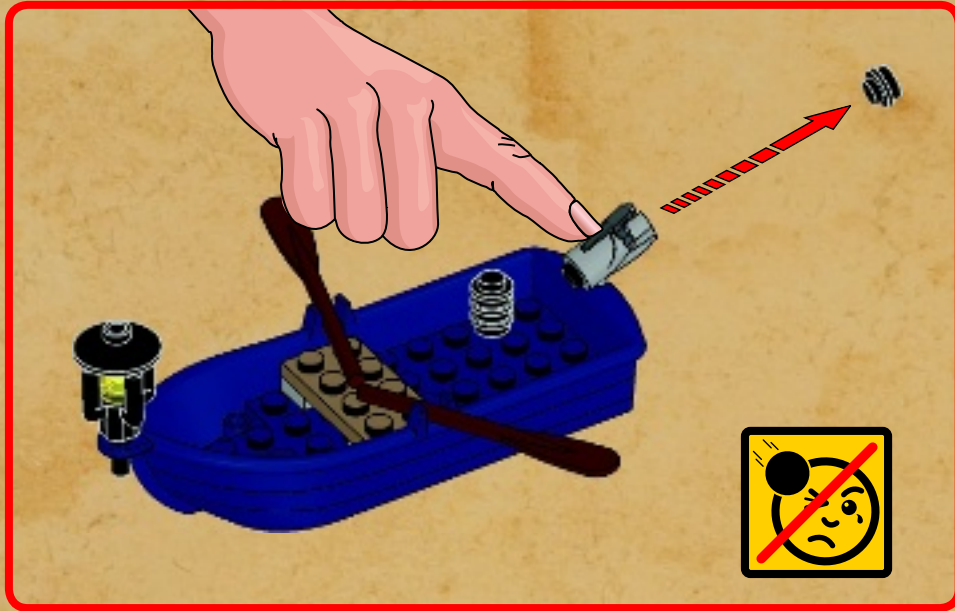

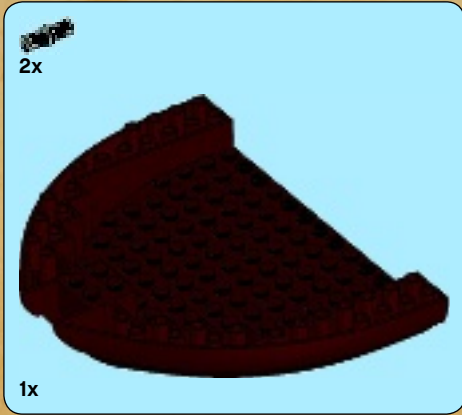

1

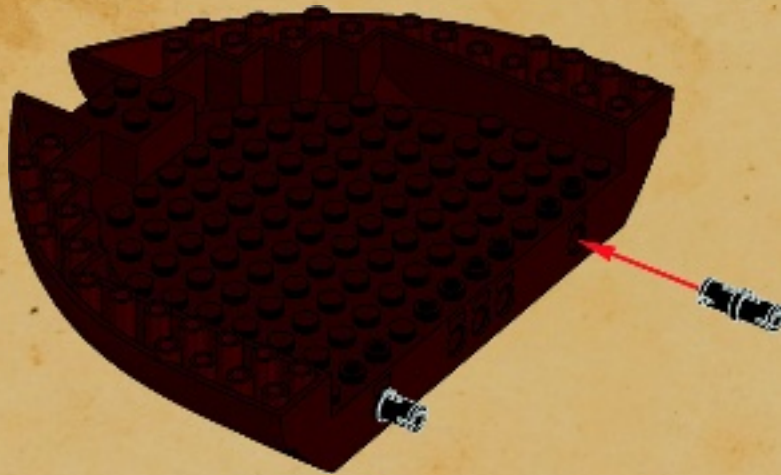

2

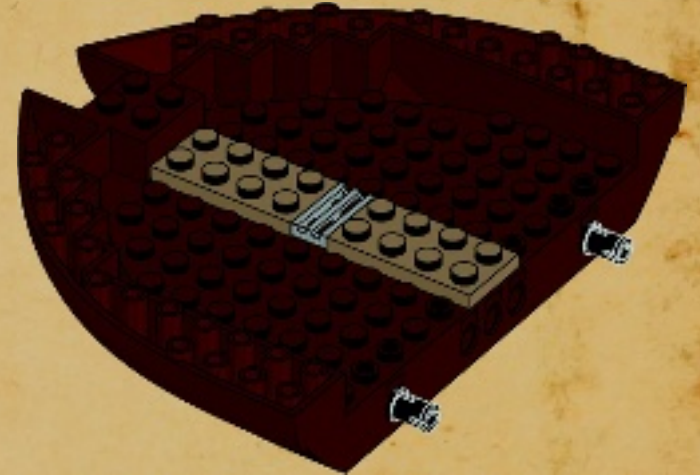



3

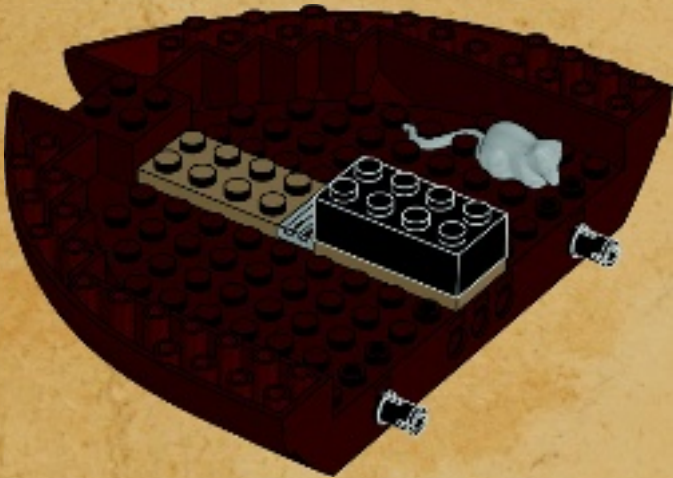

4





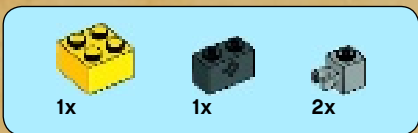

5

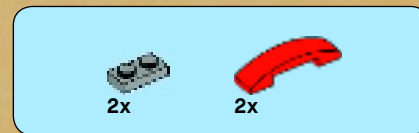
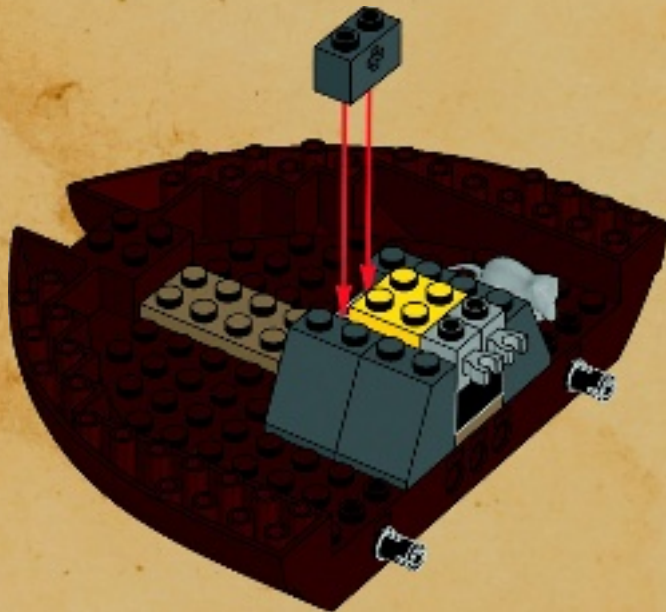

6

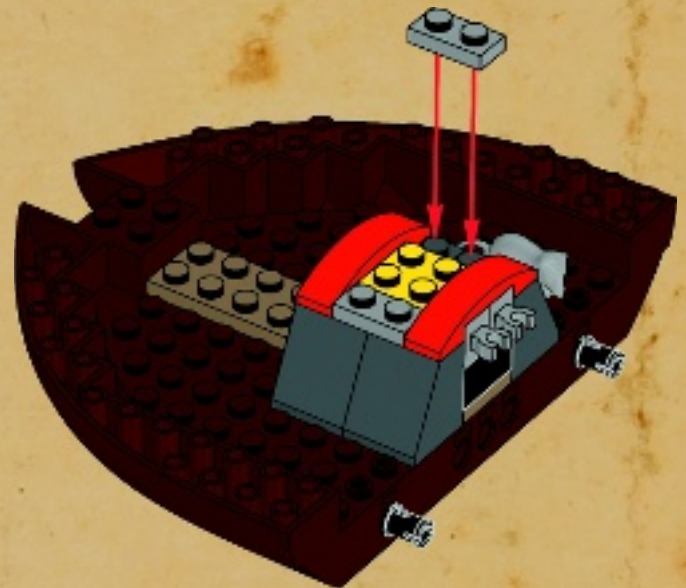

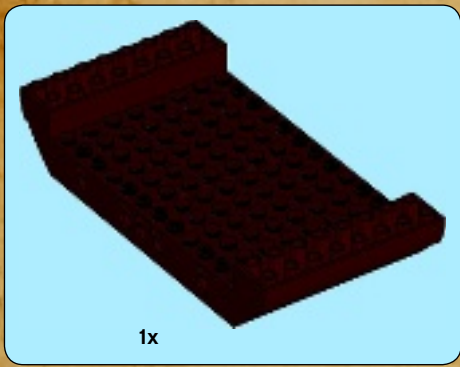

7

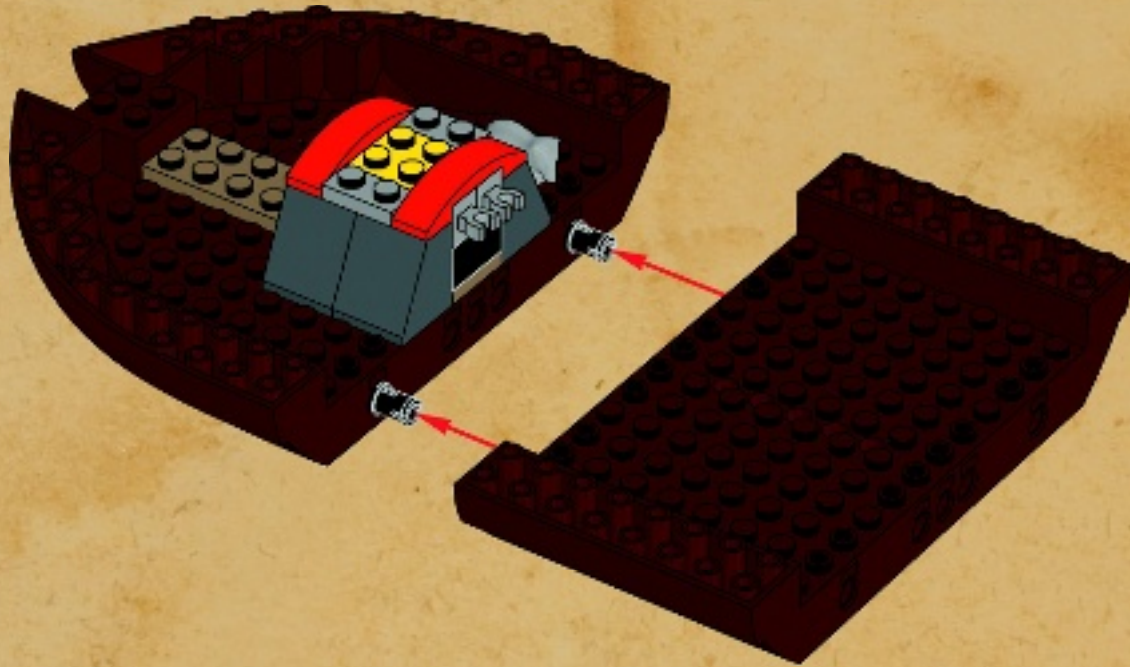

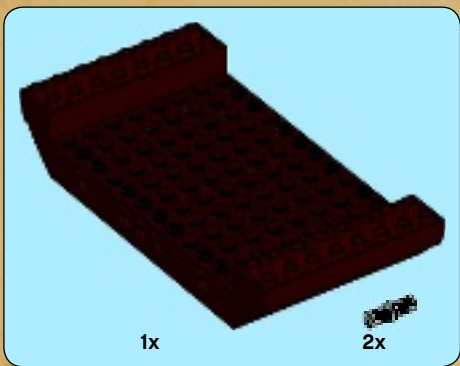

8

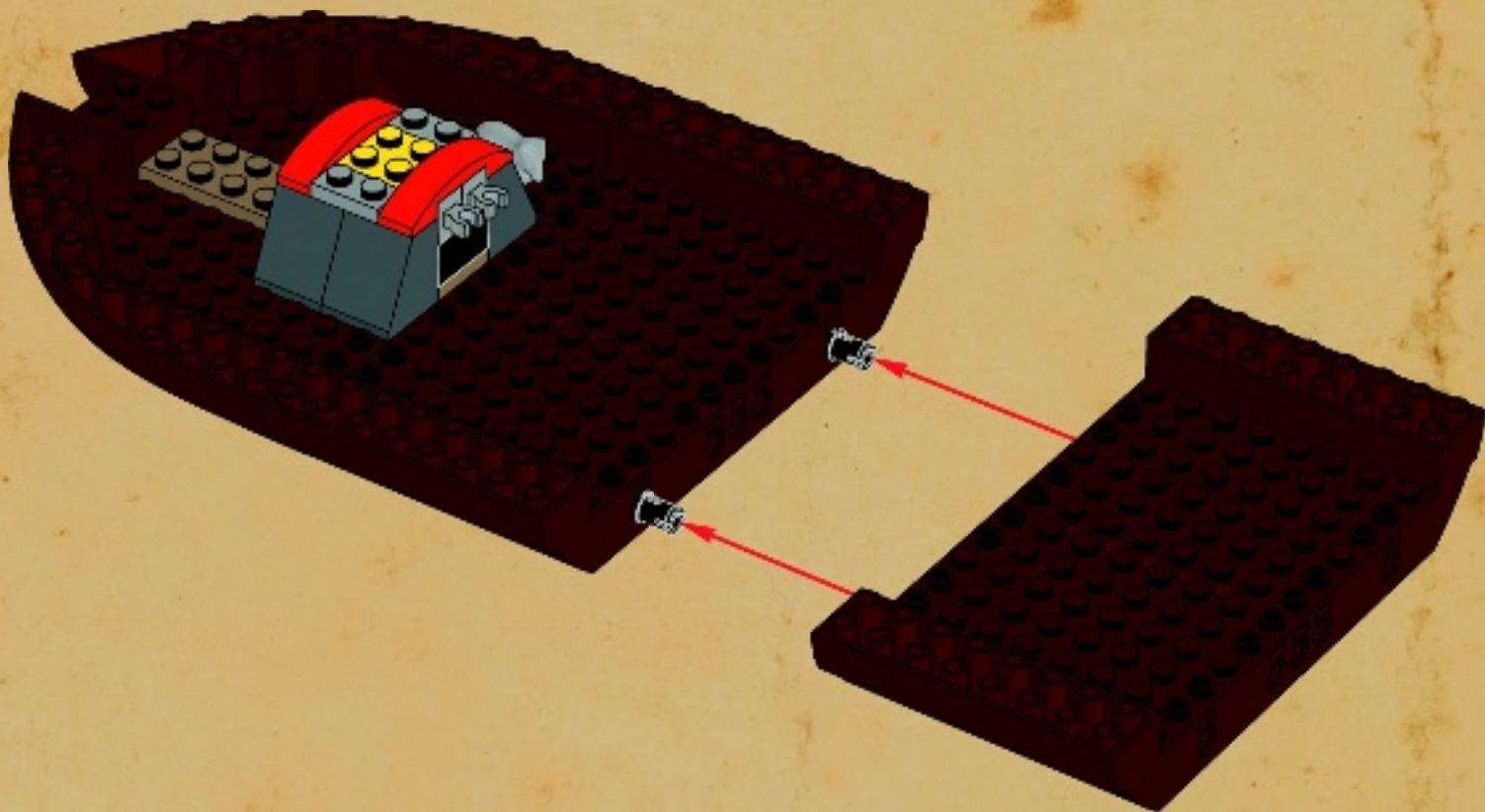

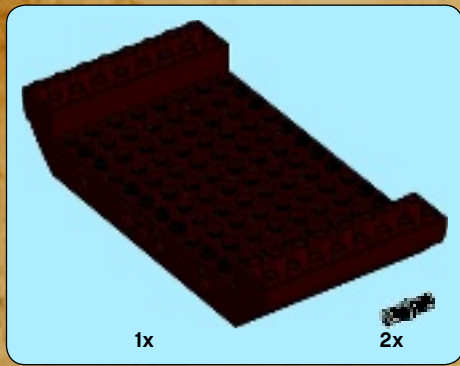

9

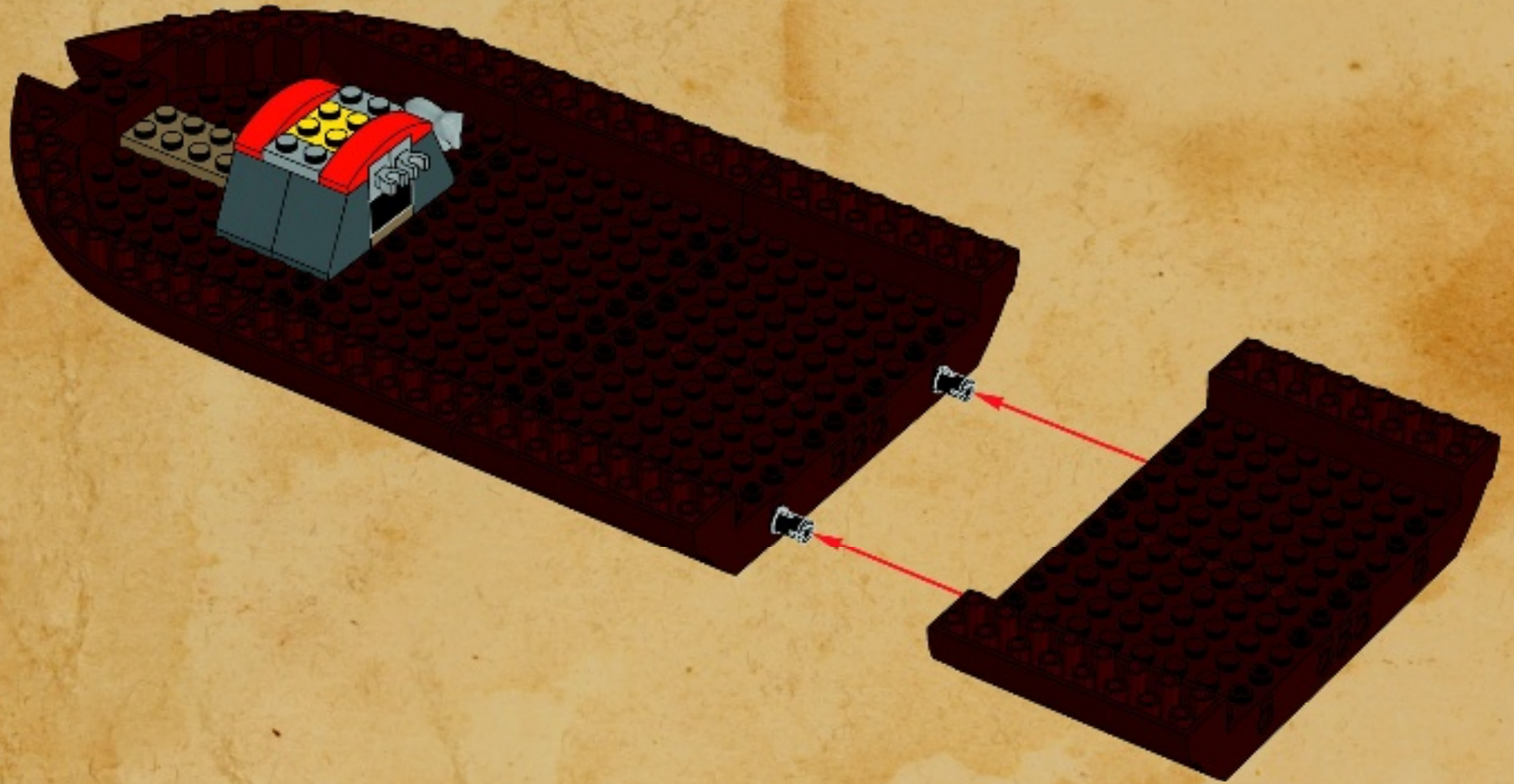

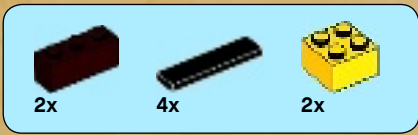

10

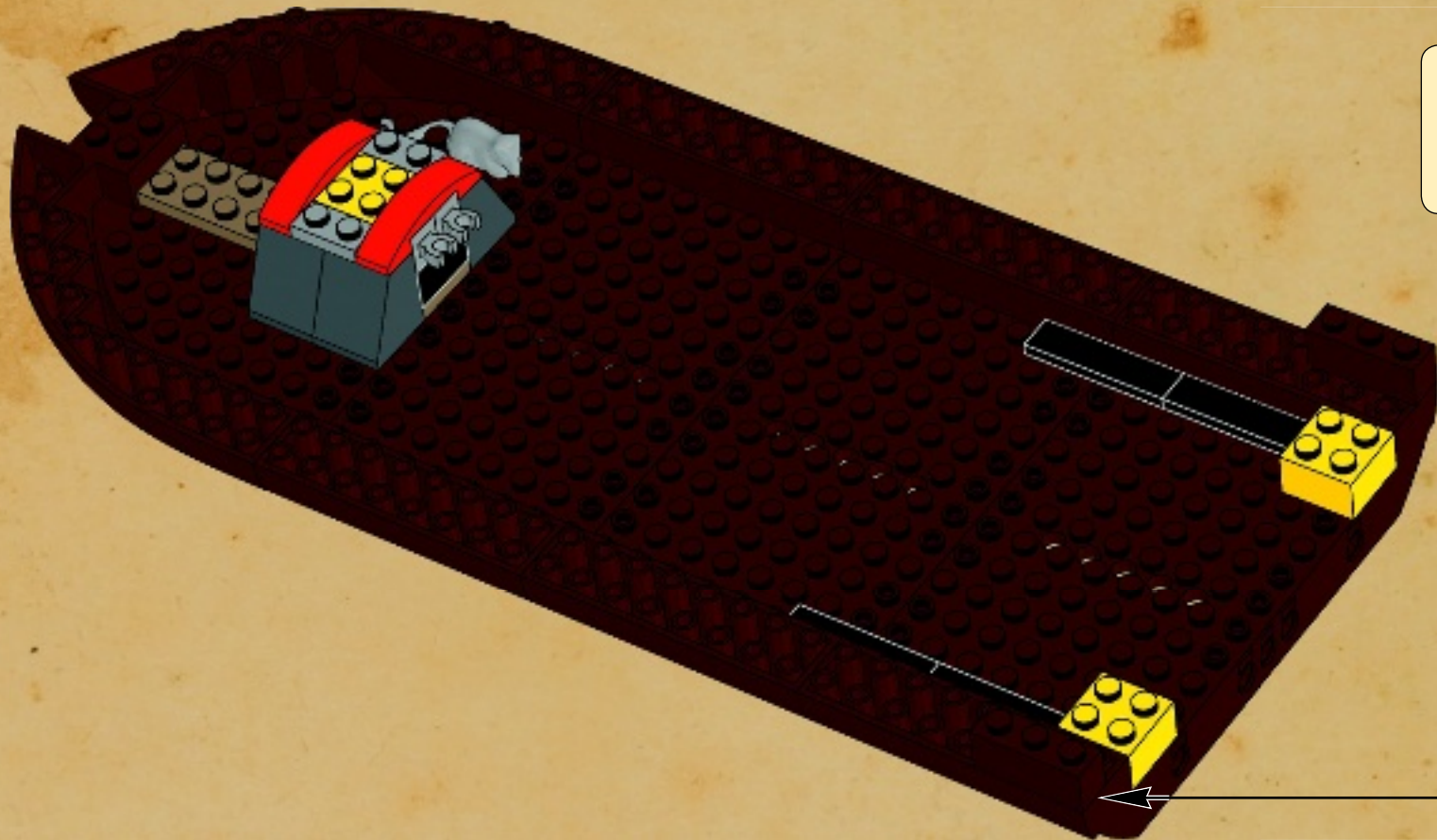

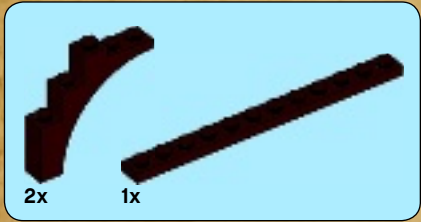

1



2





3

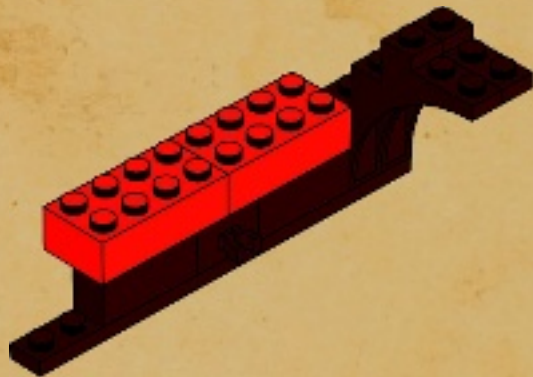

4



11

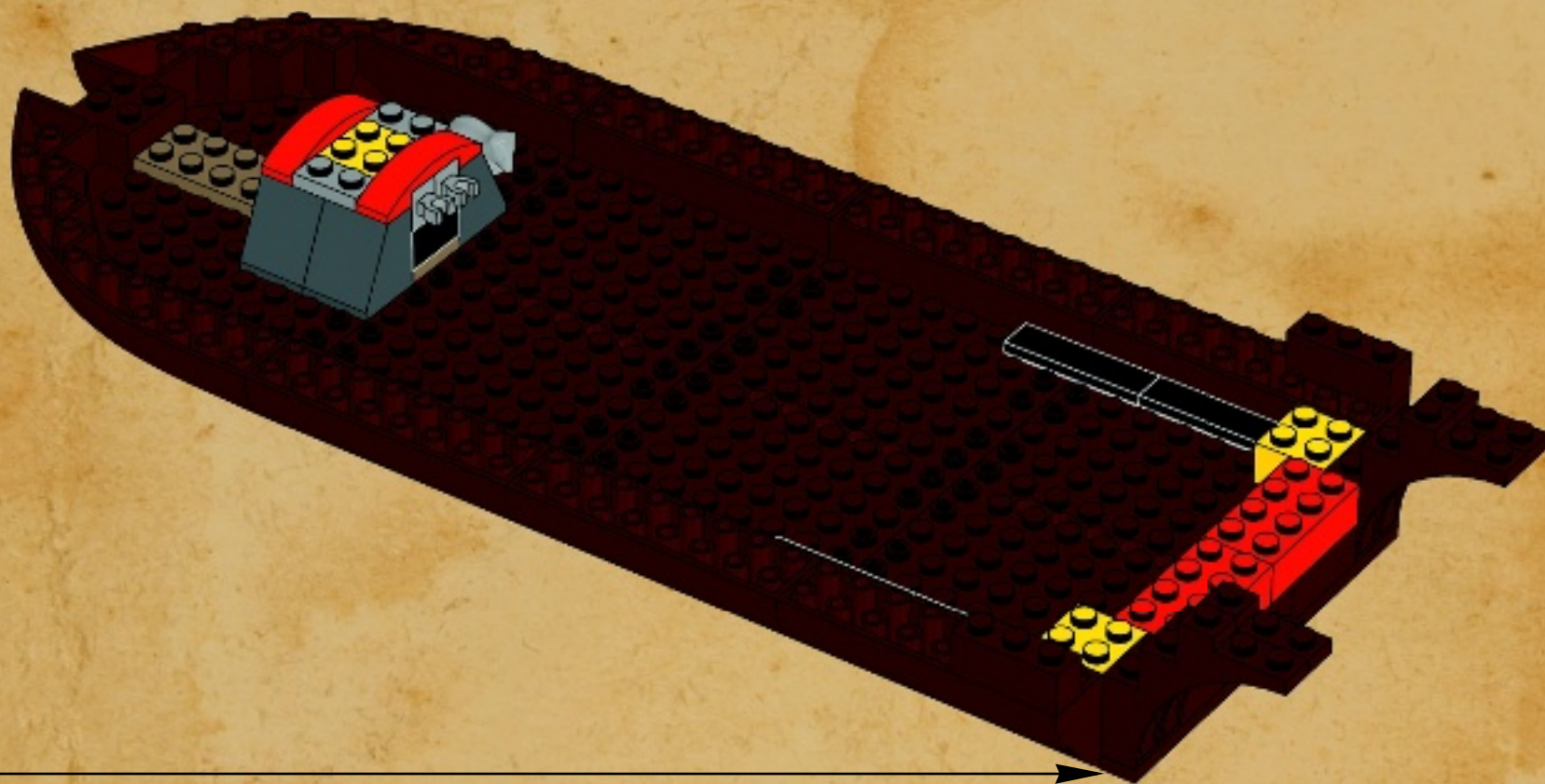





12

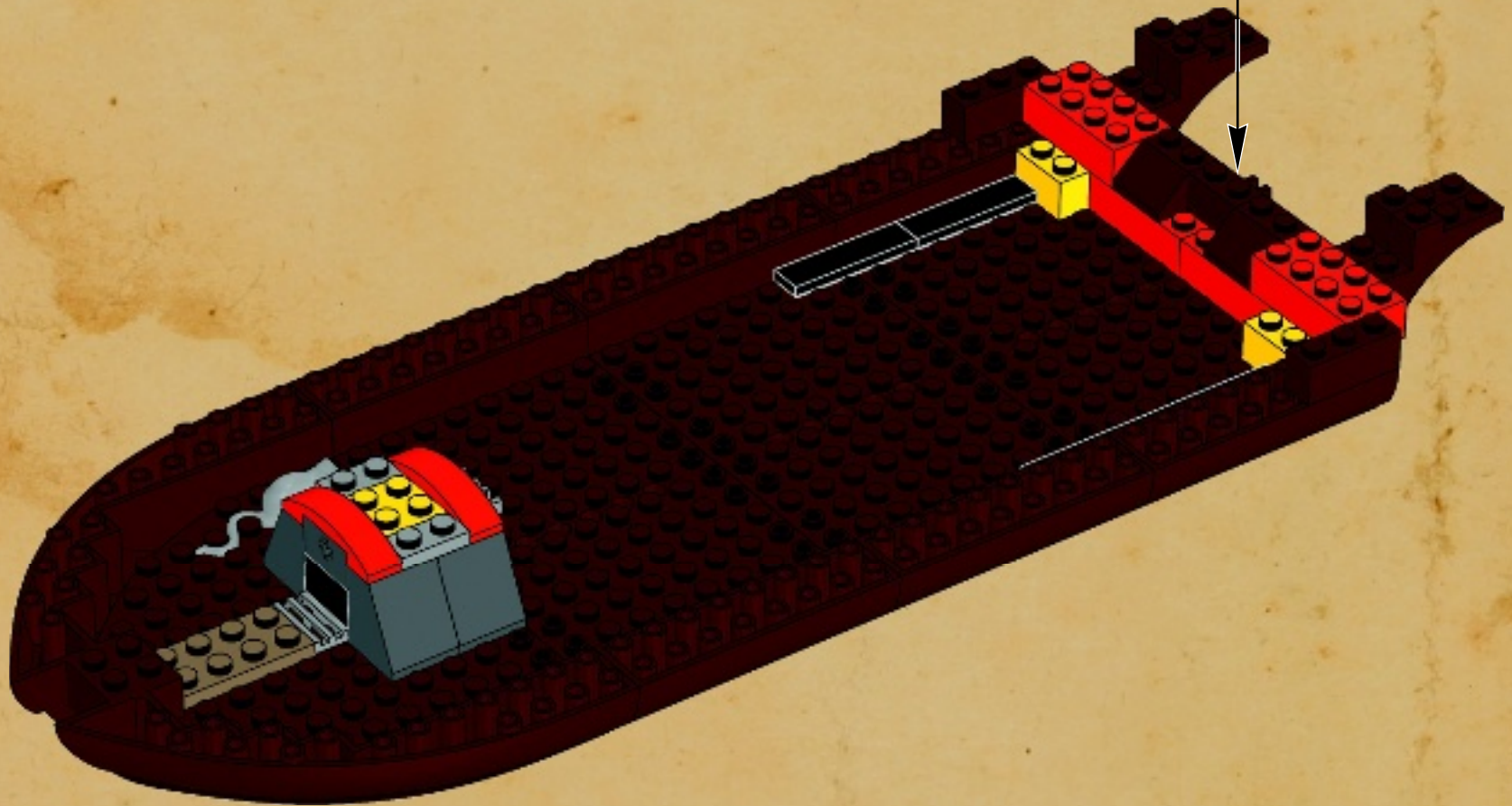

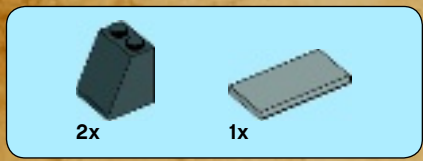

# 13

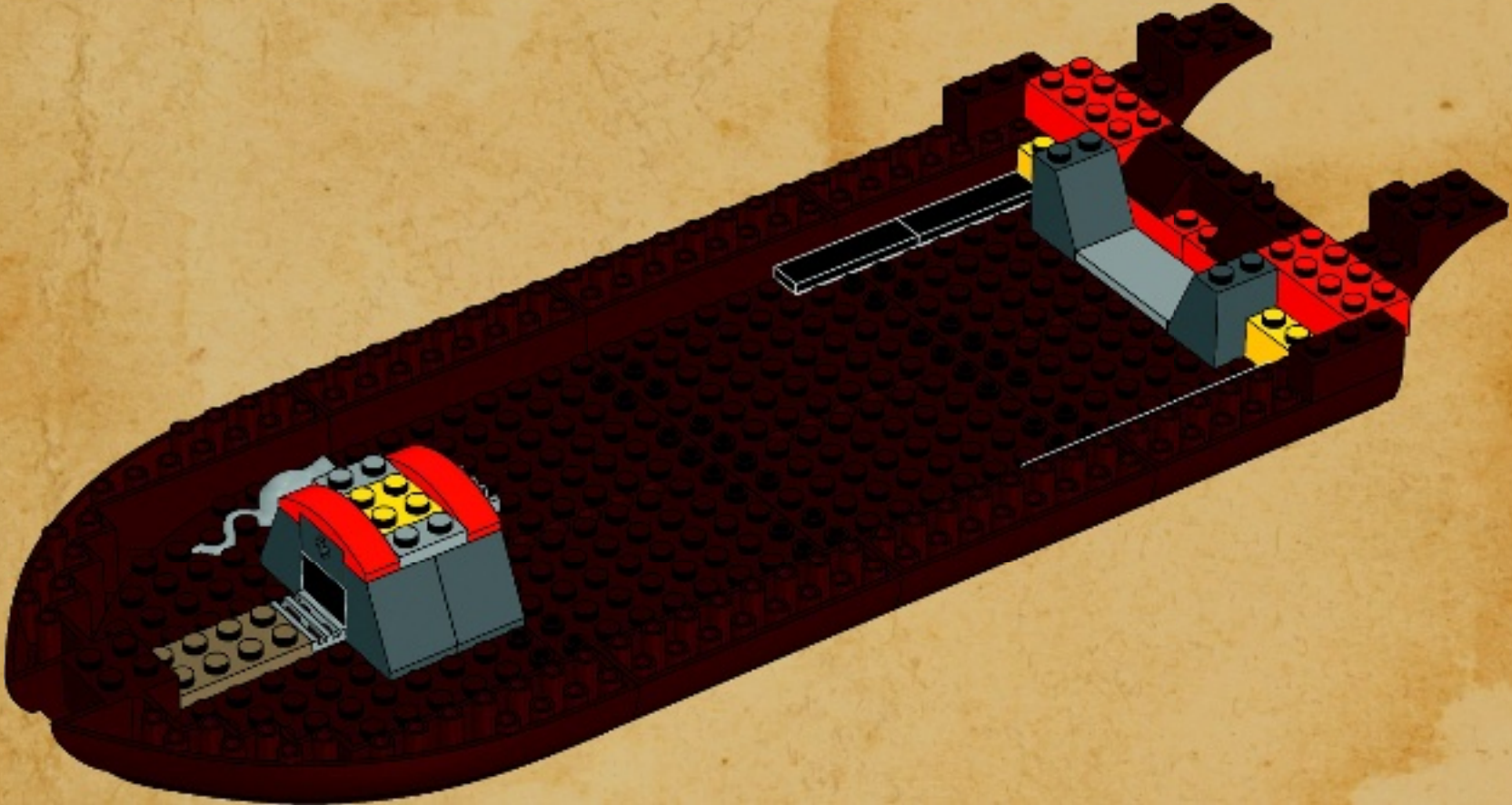

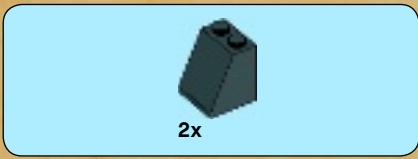

14

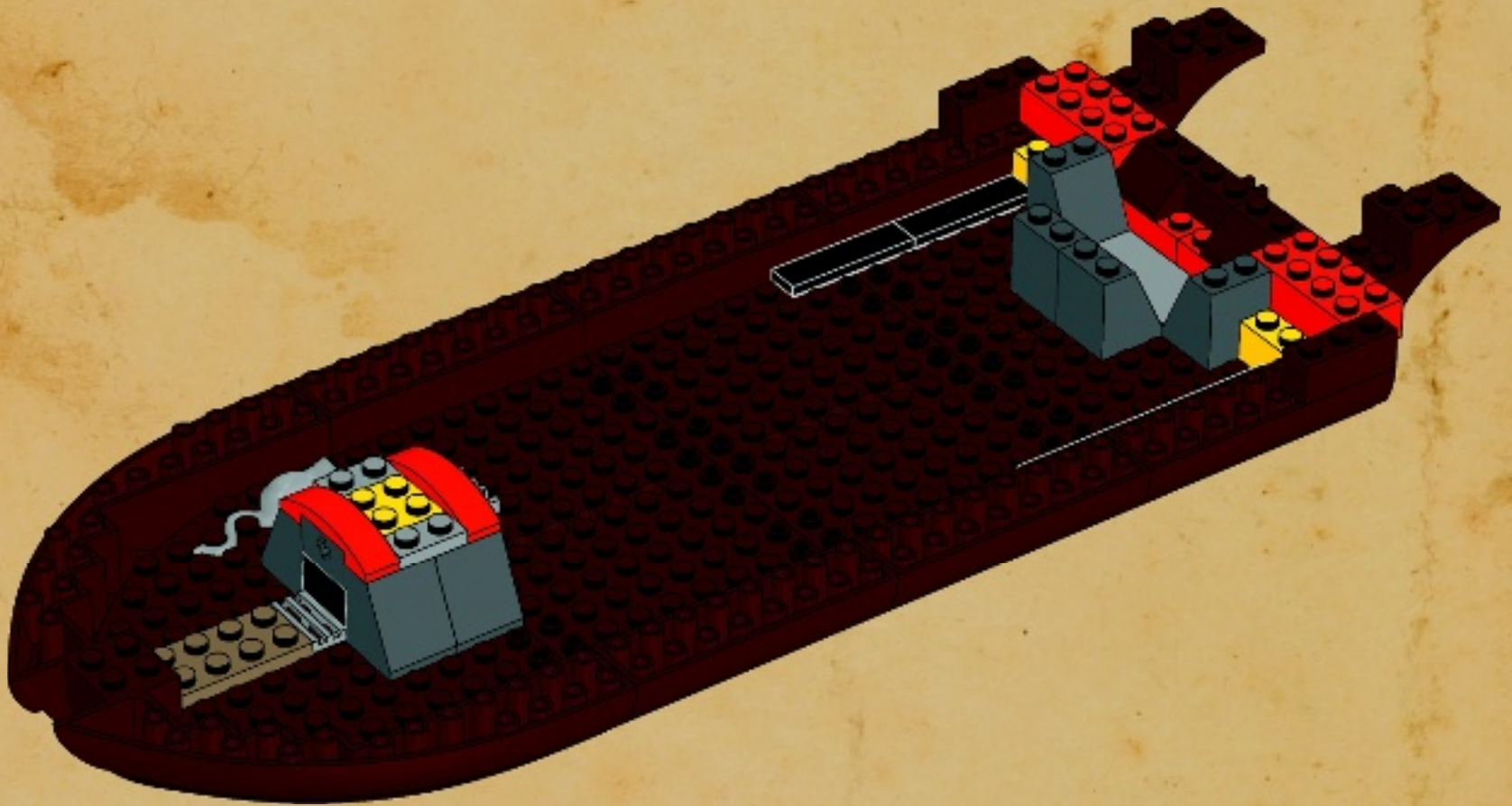



15

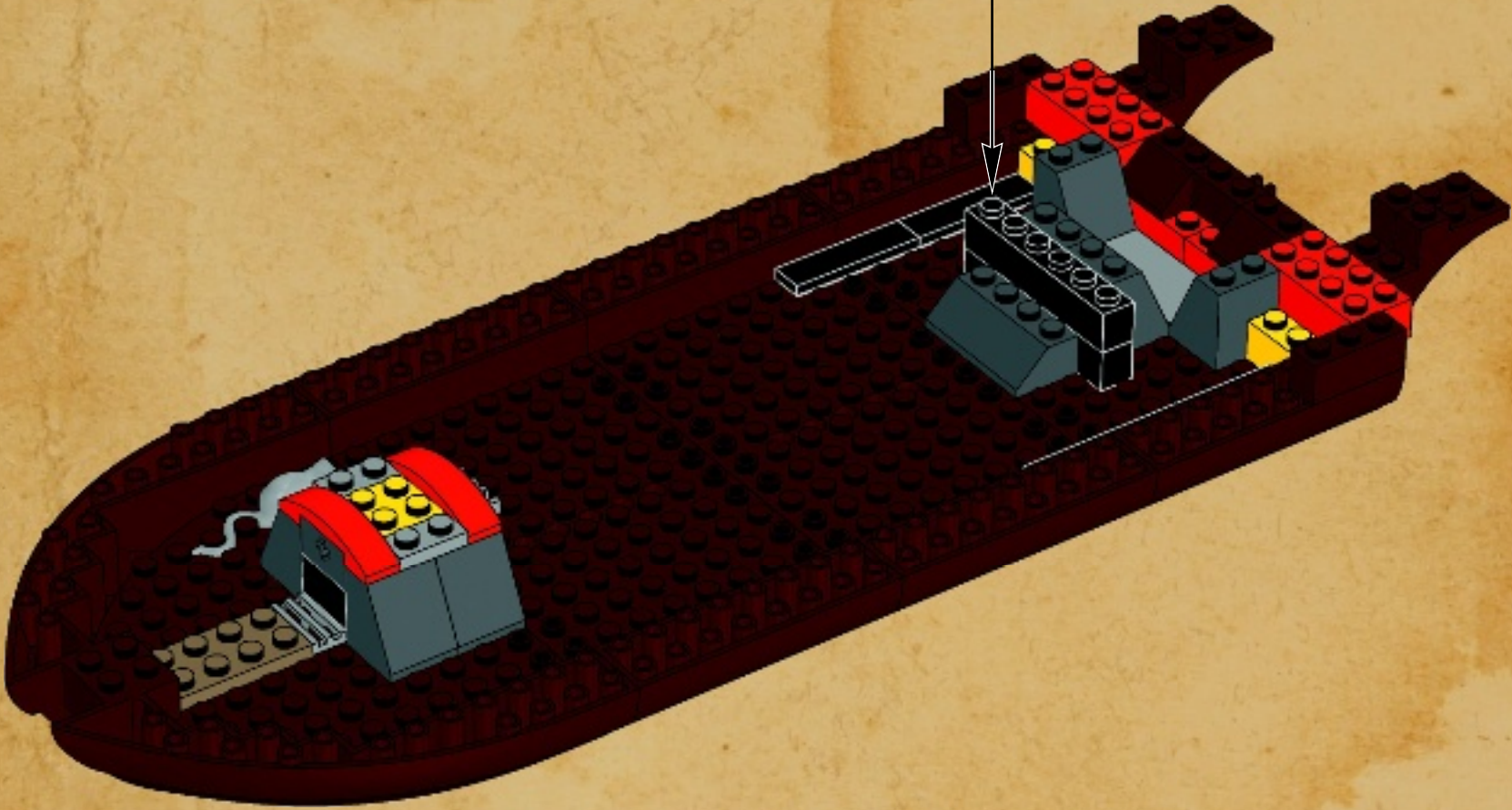
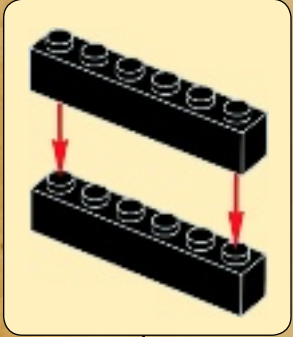



16

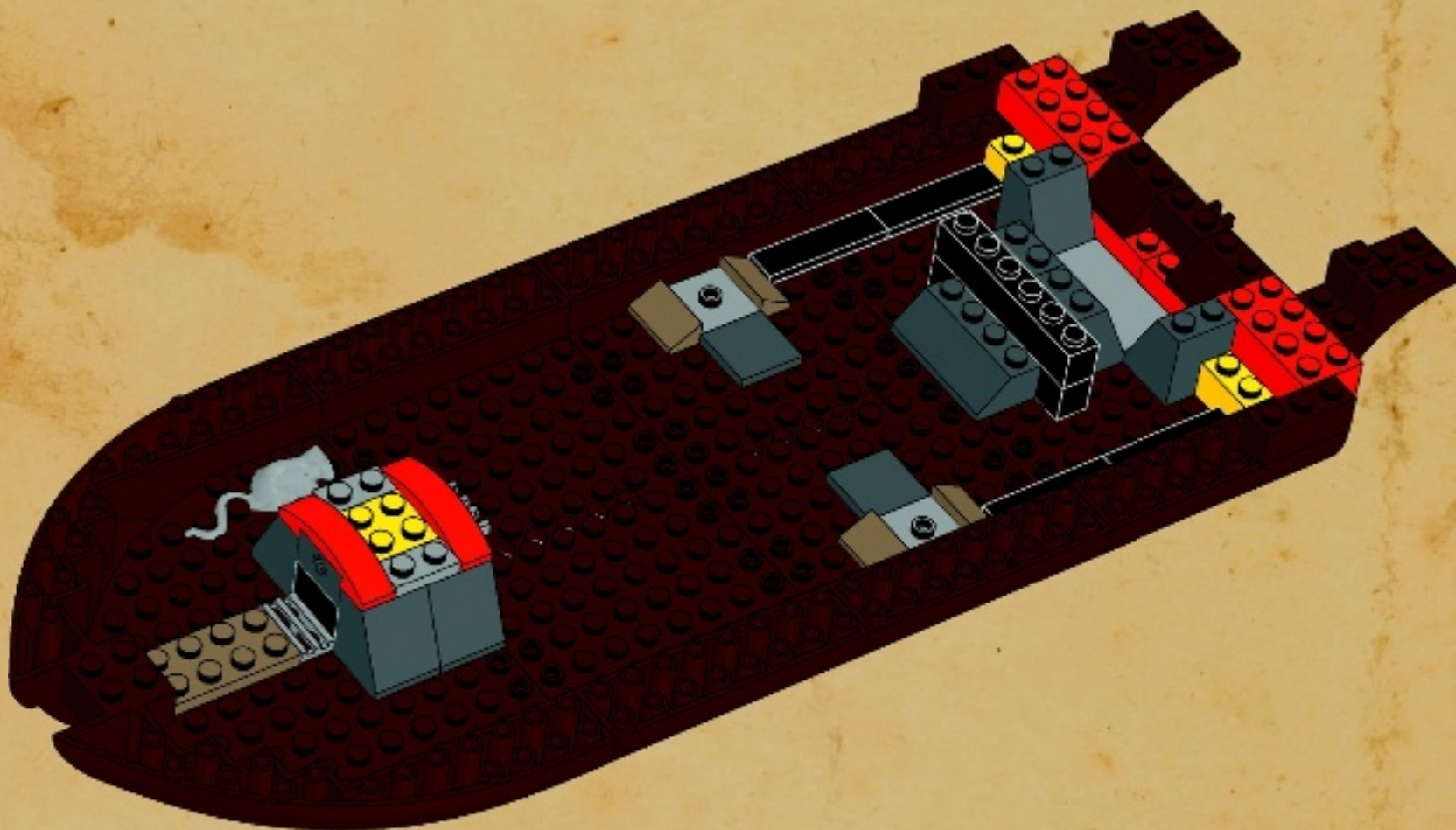

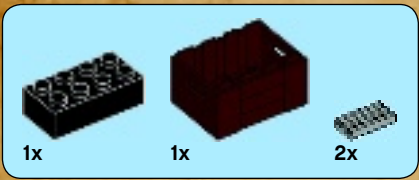

17

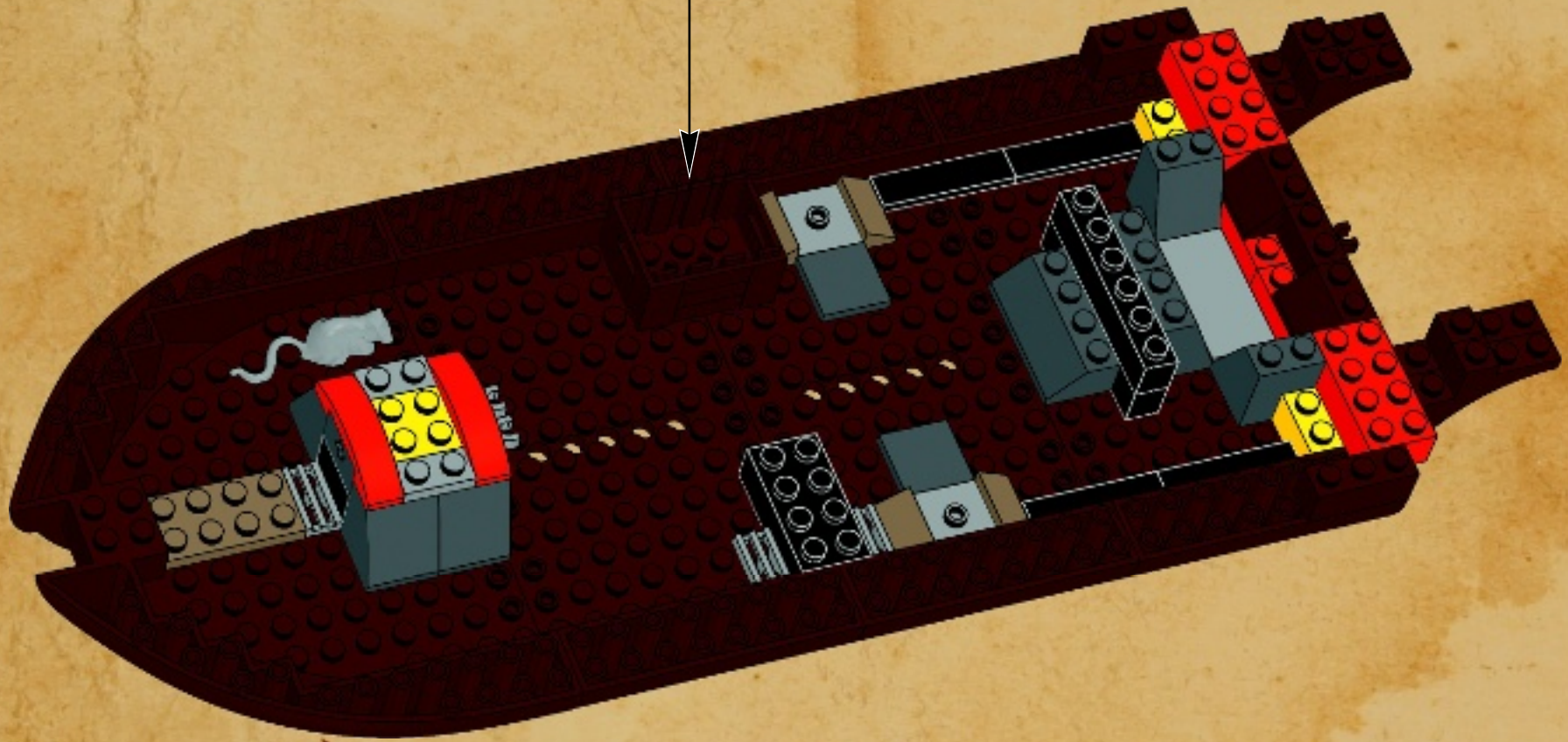



18

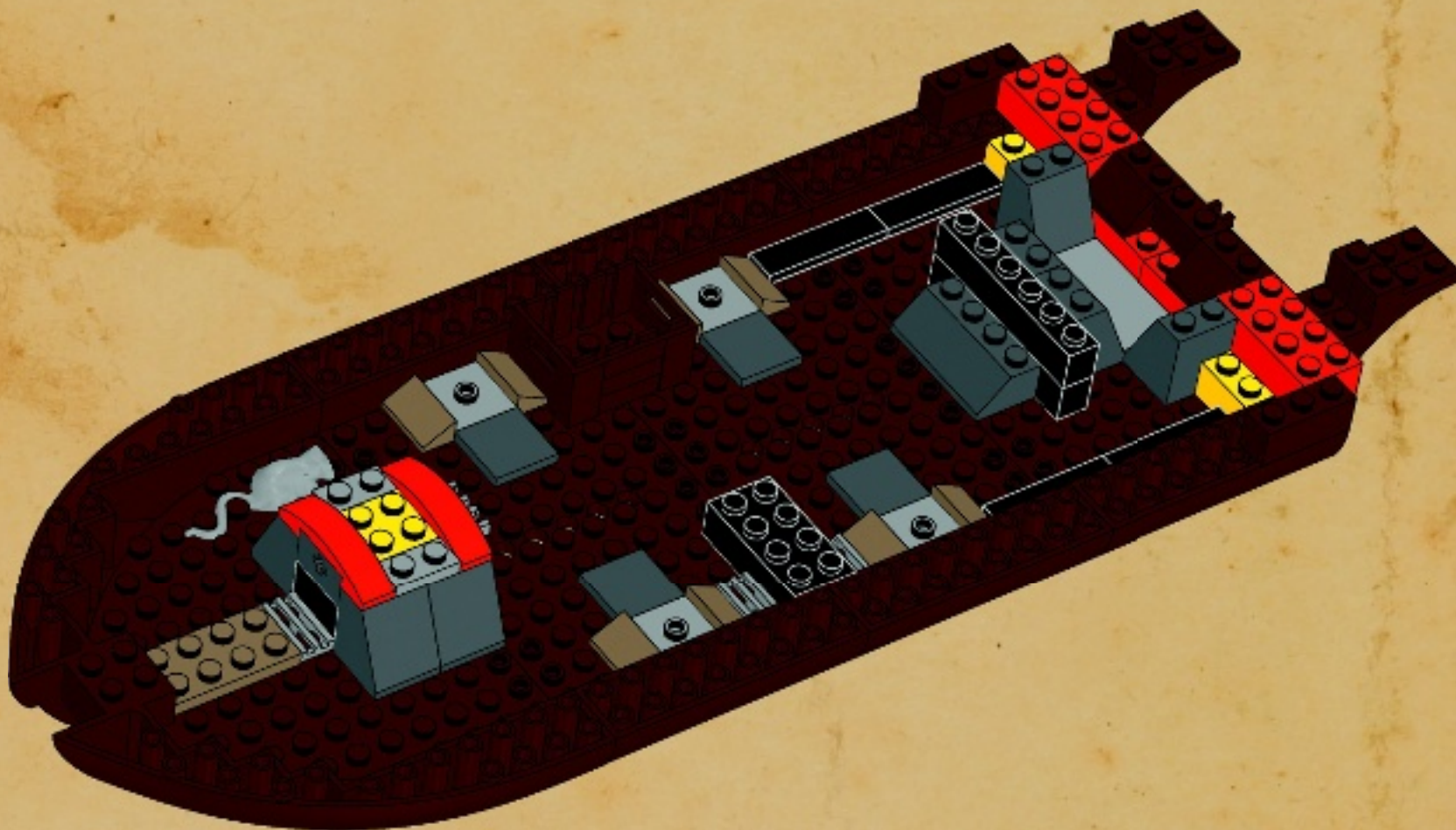



19

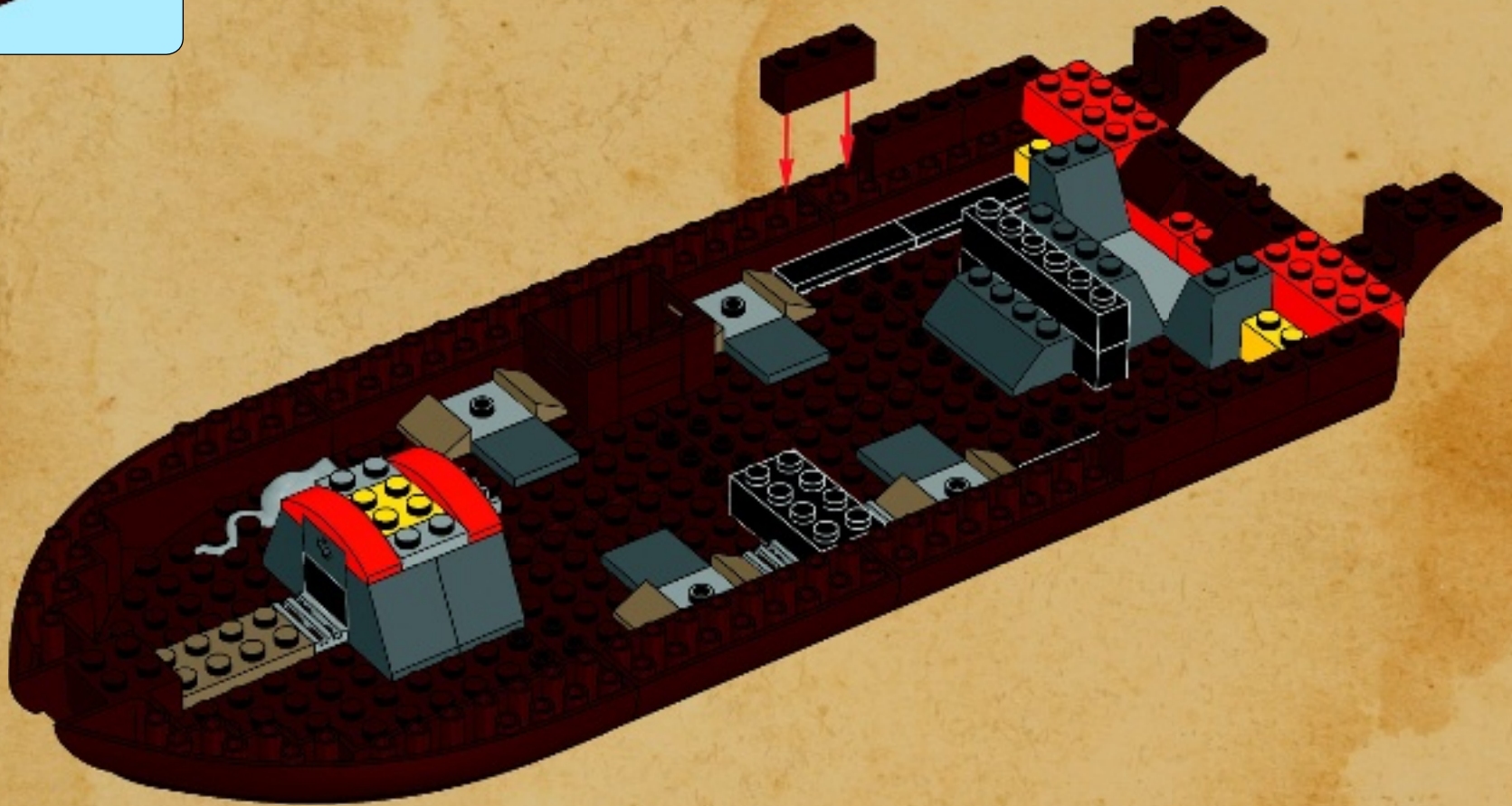



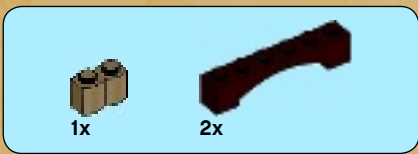

20

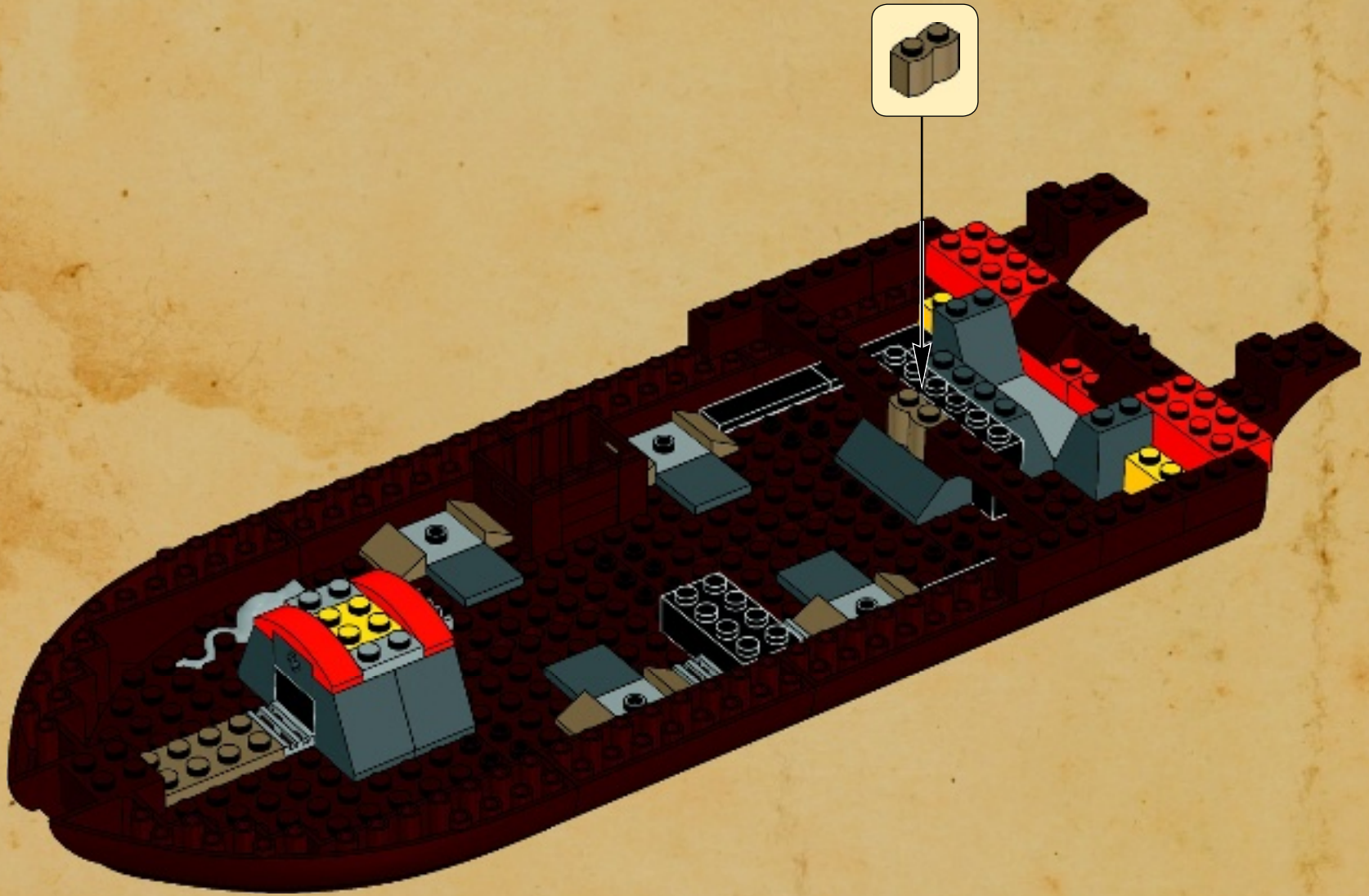



2x



2x



2x

# 21

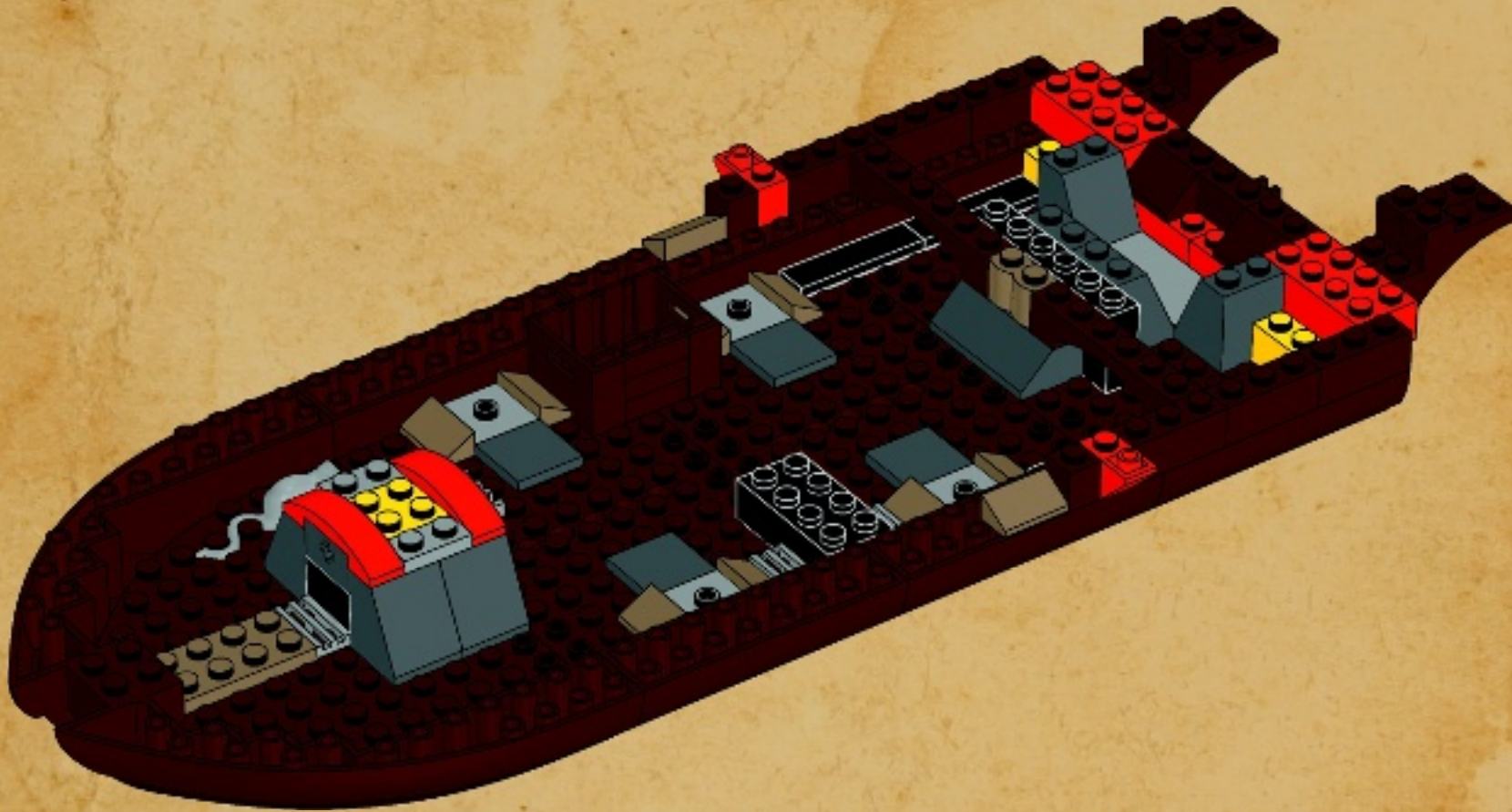

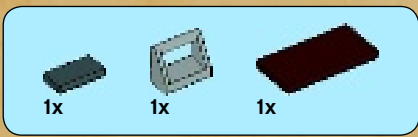

22

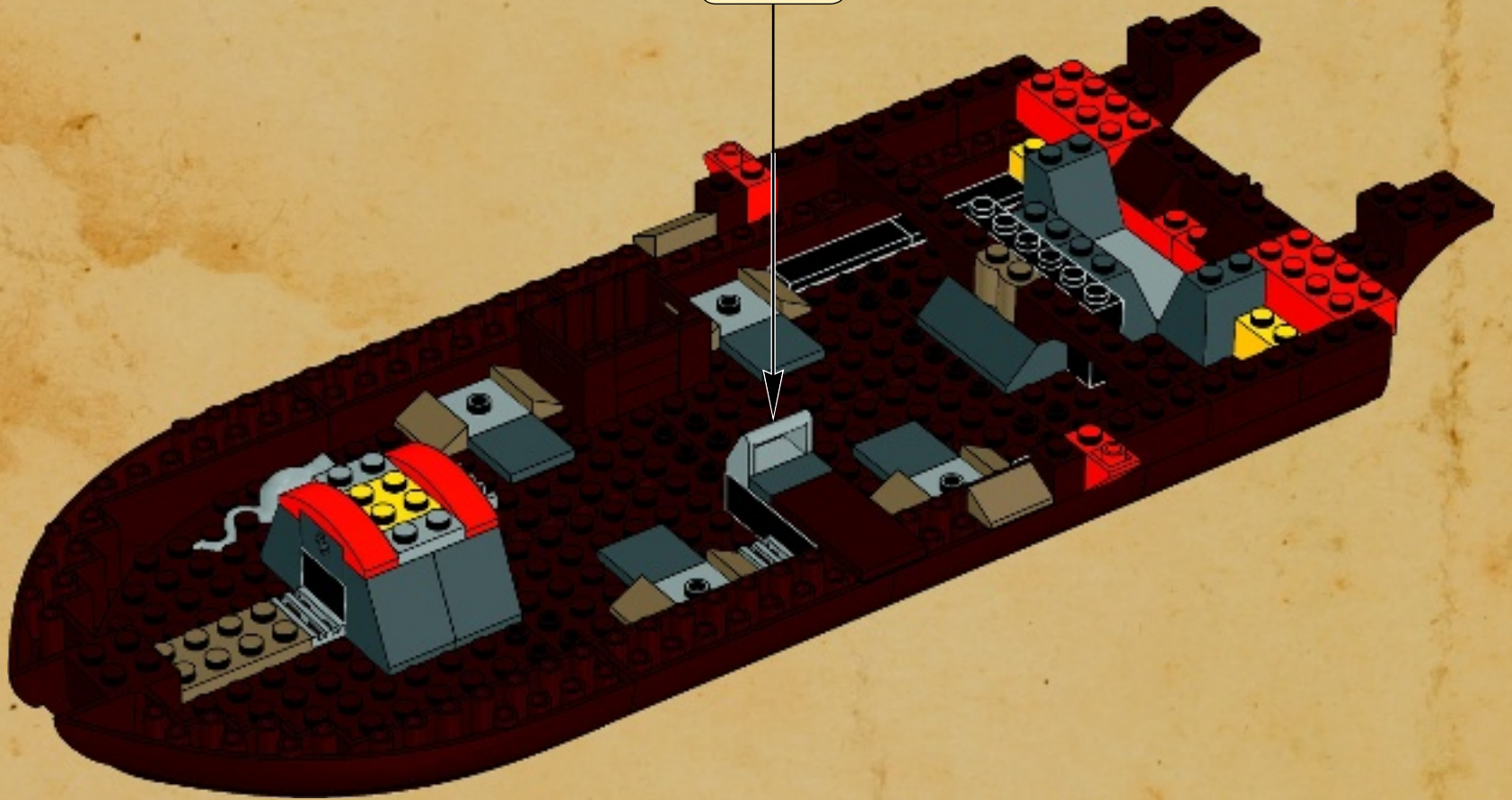
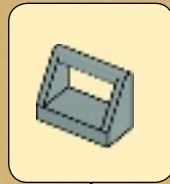

4x  1x 

# 23

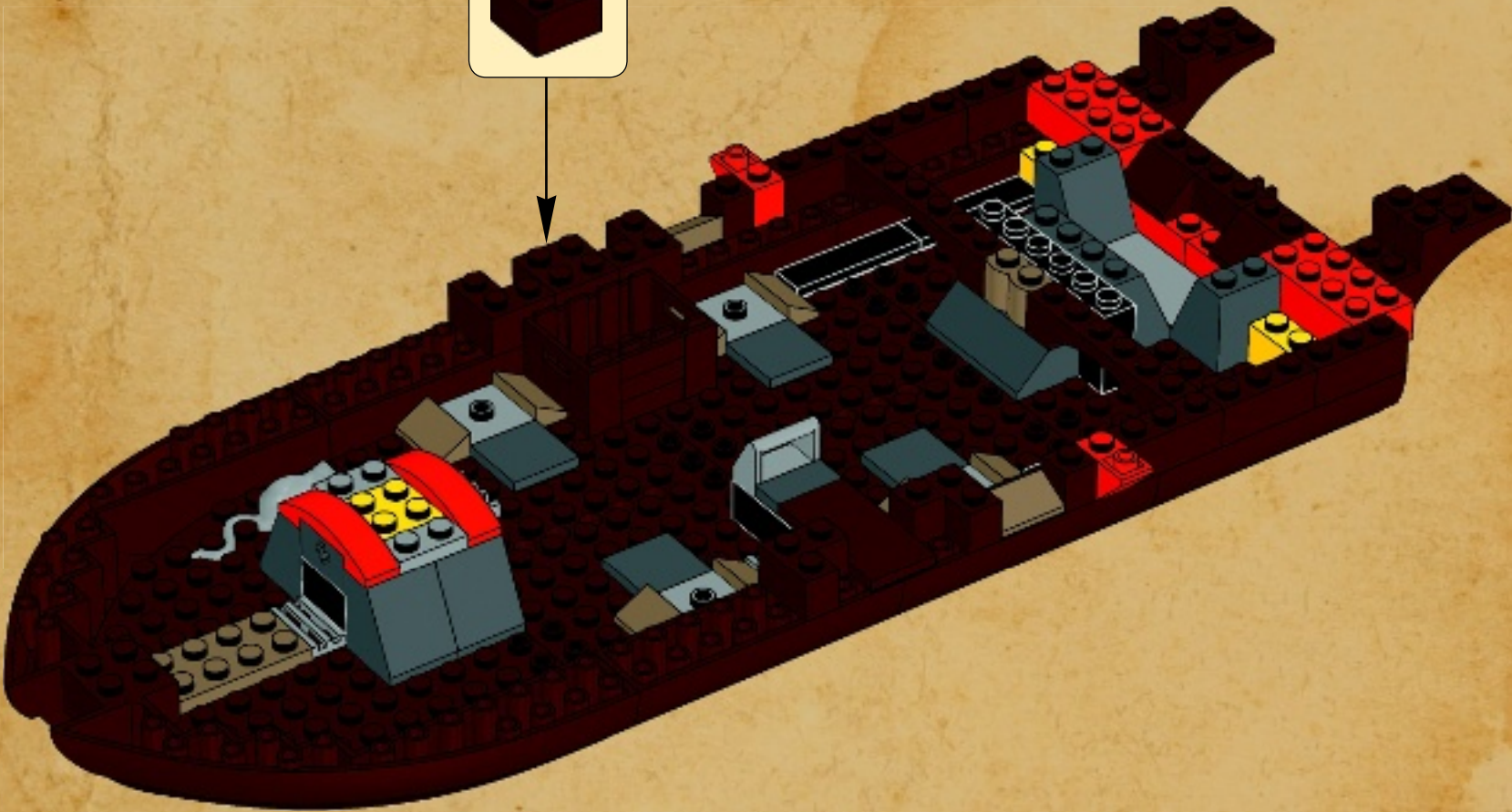



4x

24

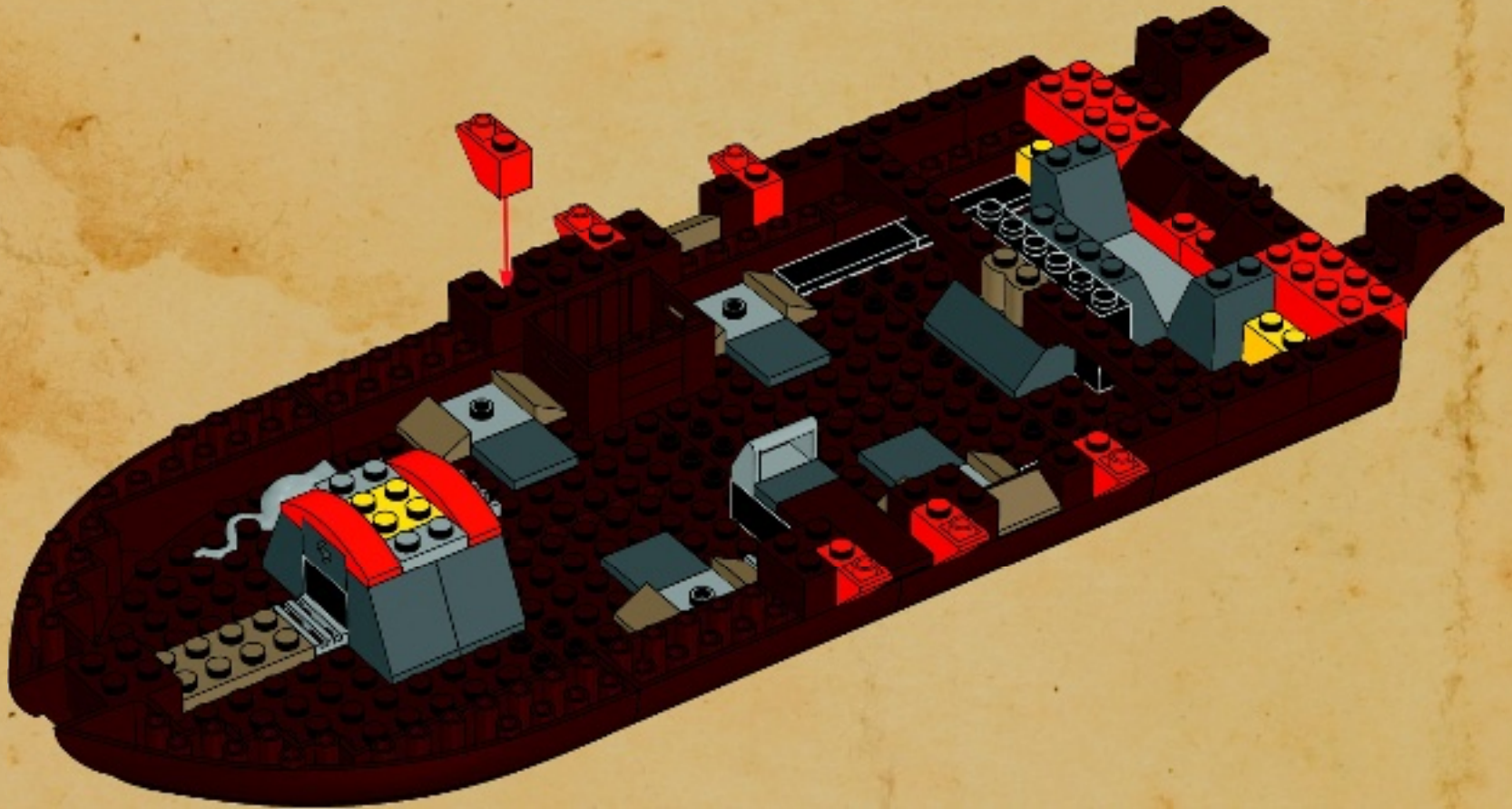

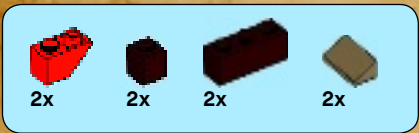

25

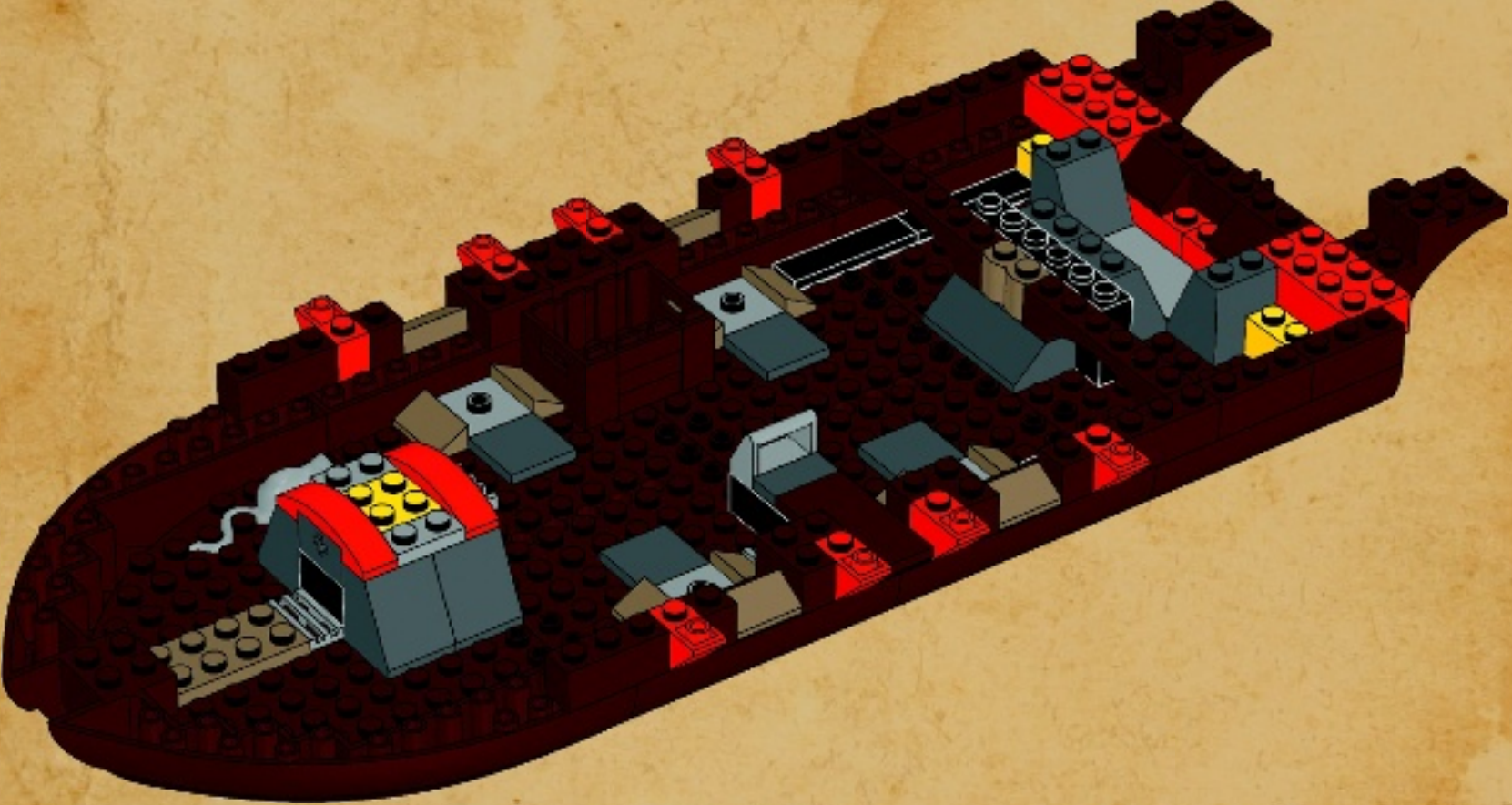



4x



2x

# 26

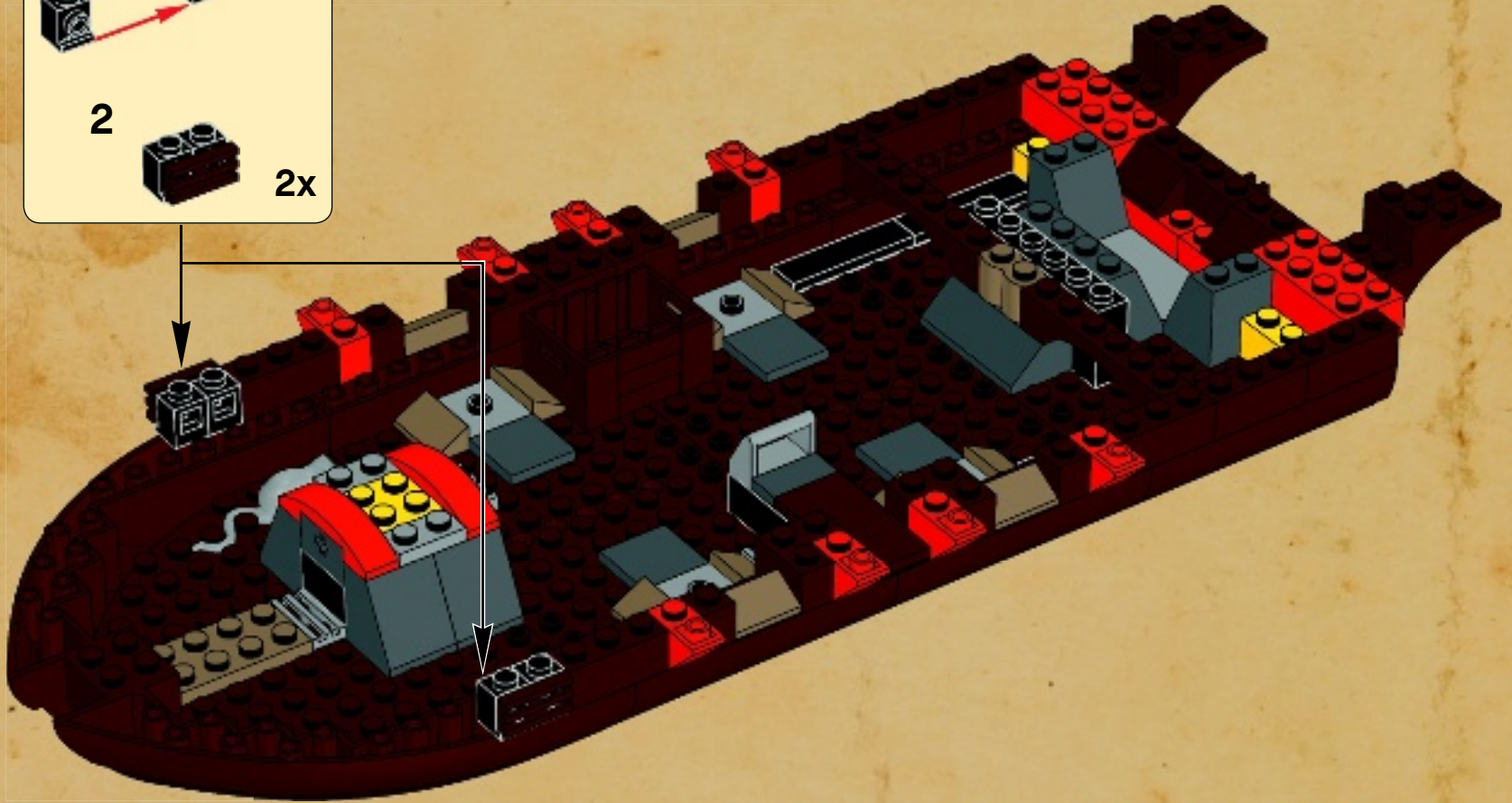
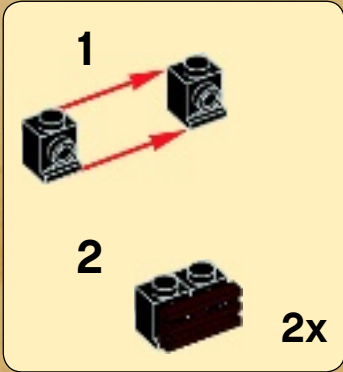

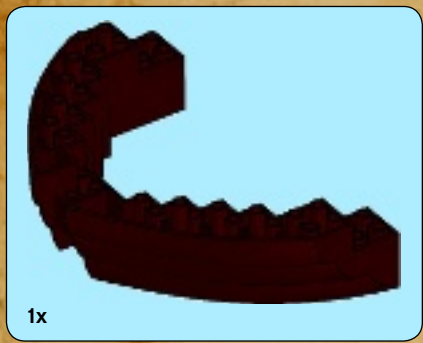

27

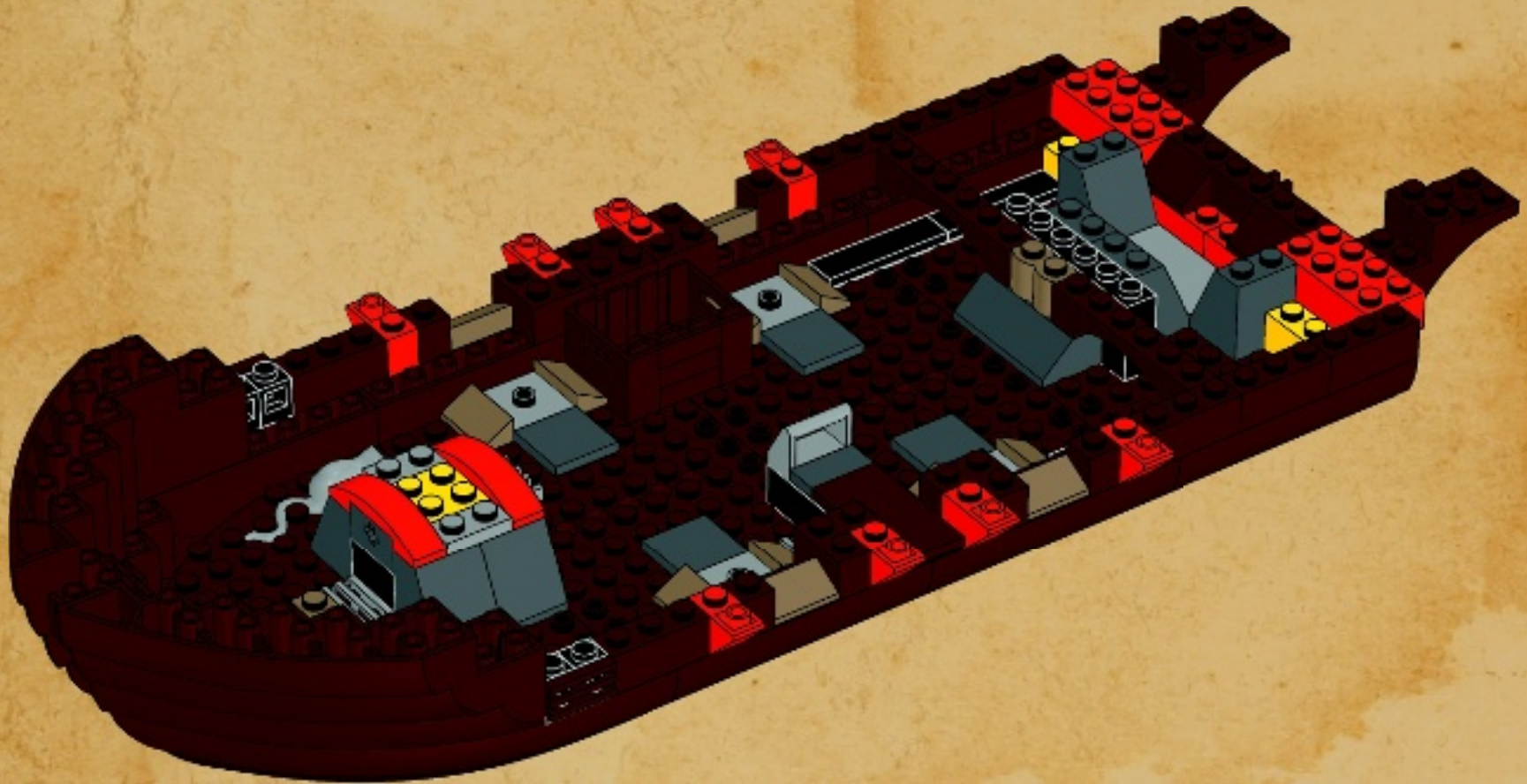





28

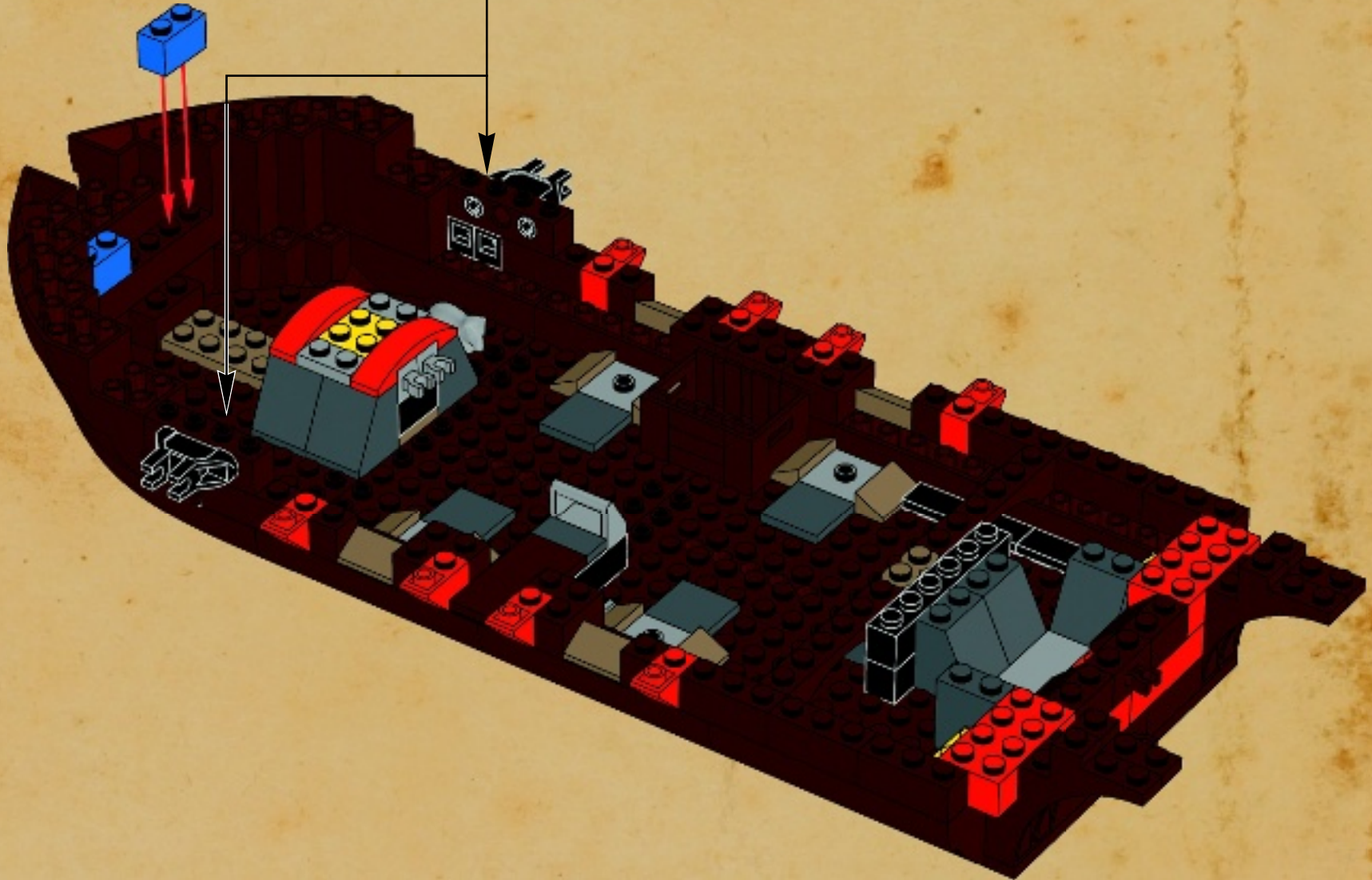
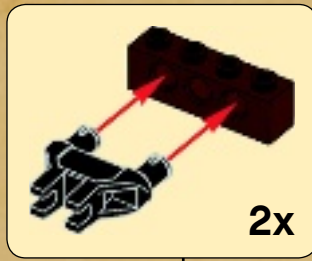

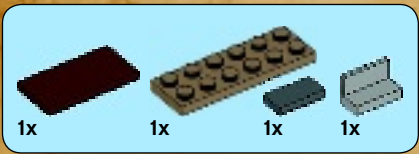

29

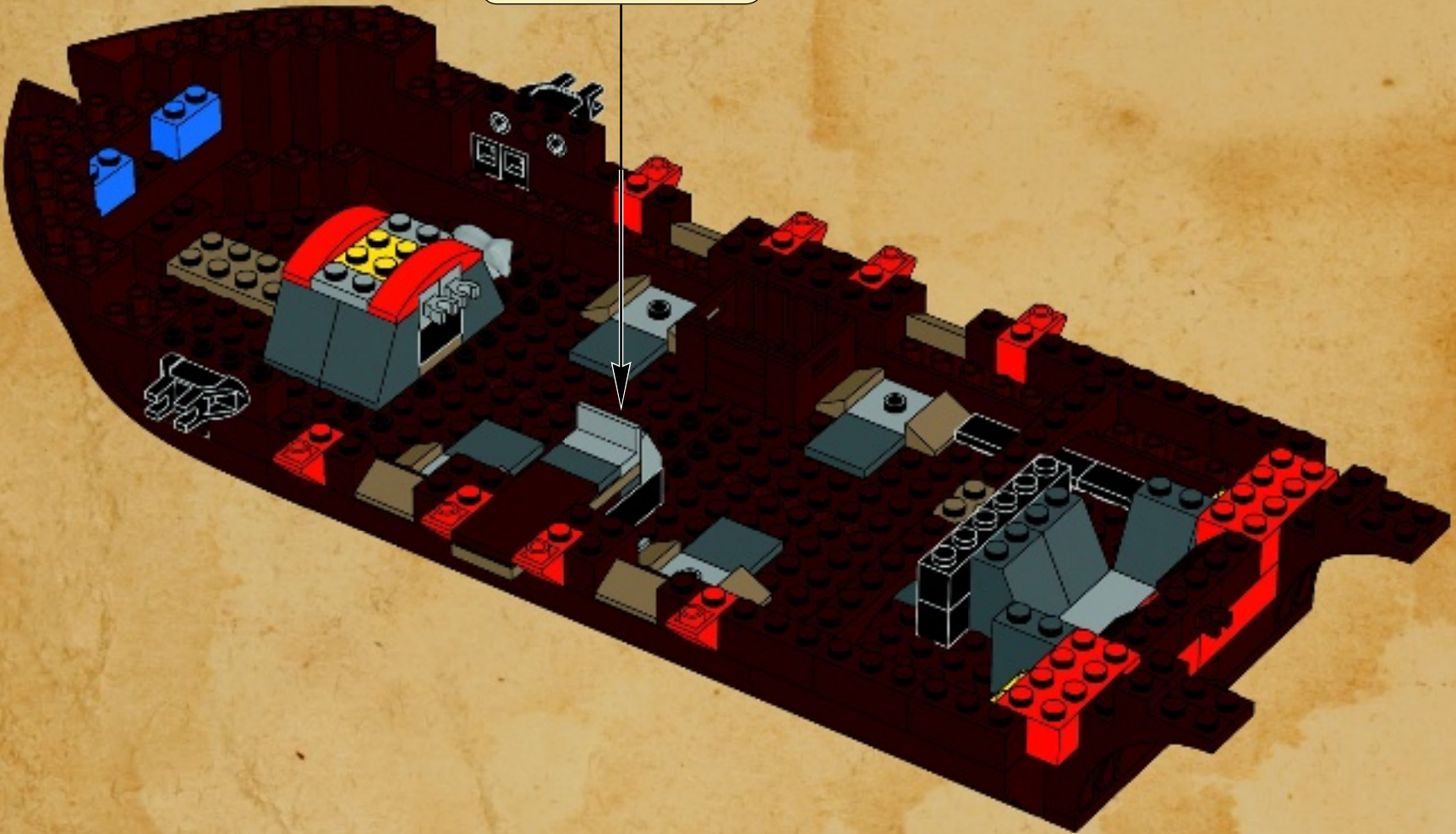
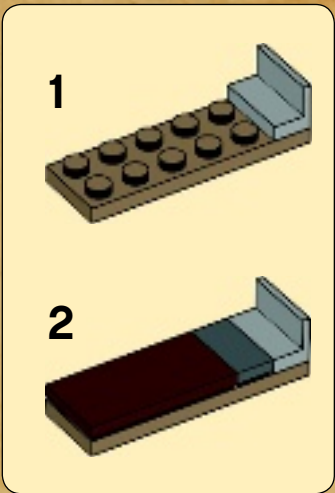

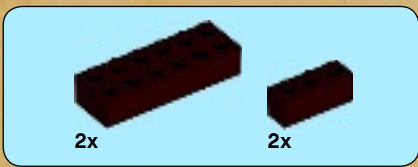

30

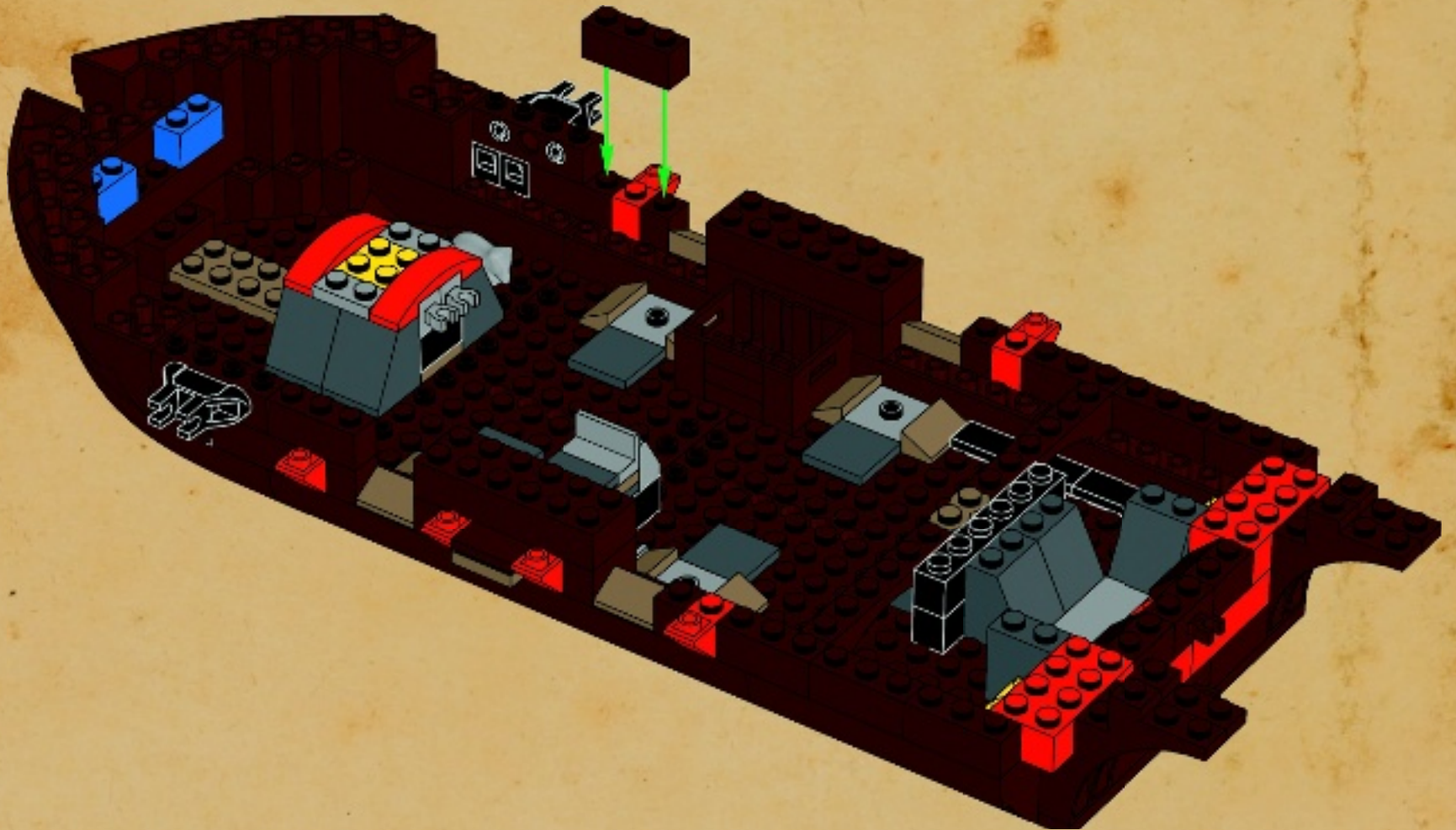



31

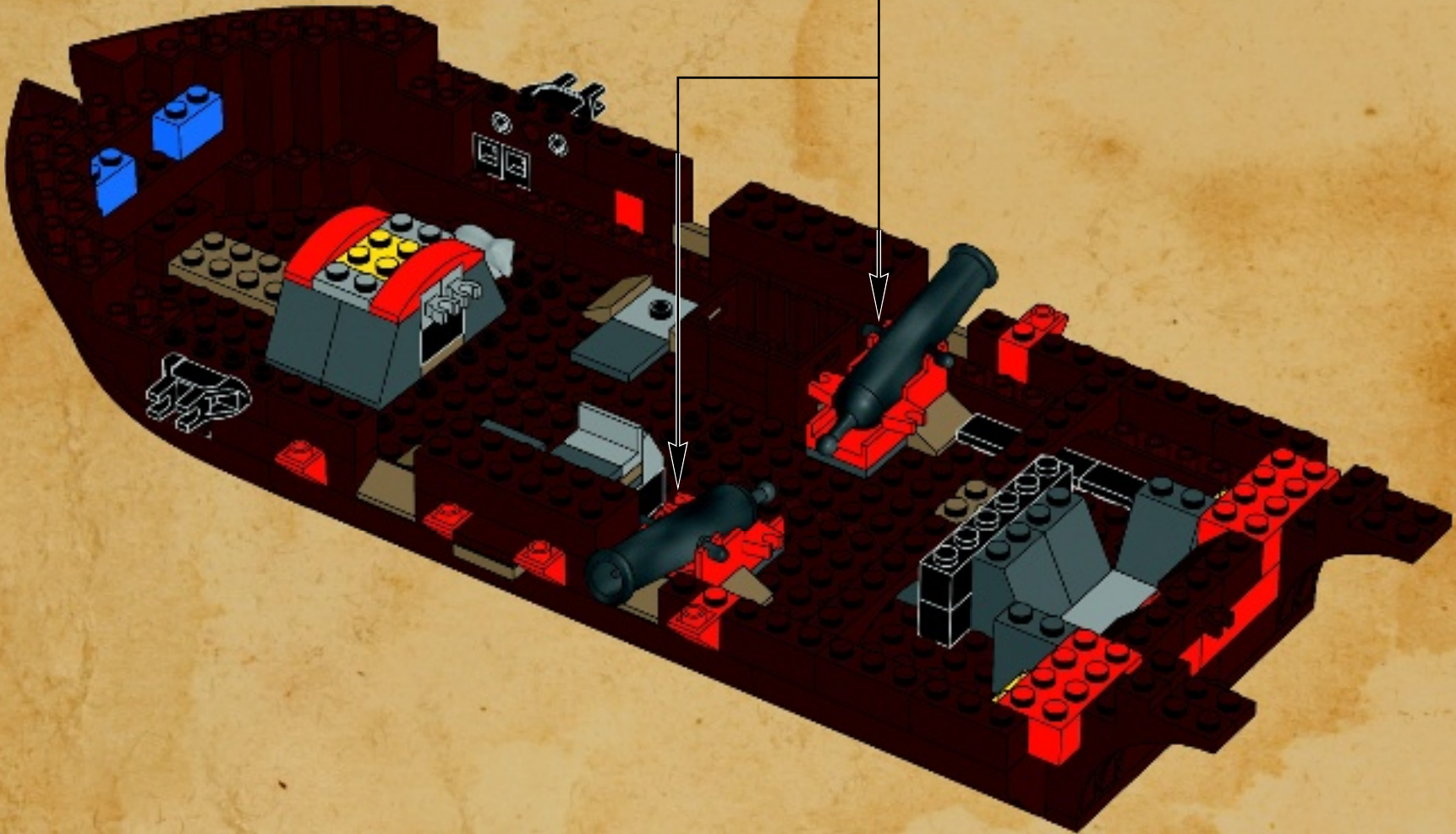
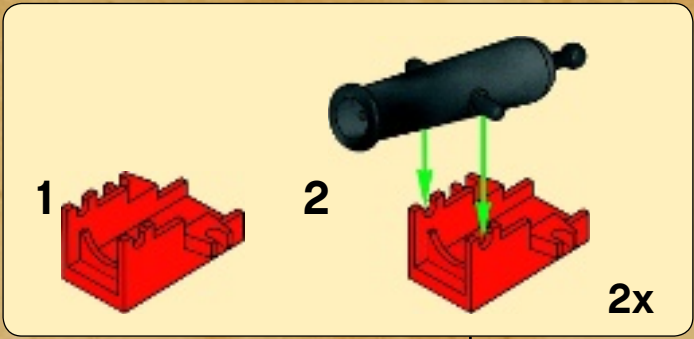



32

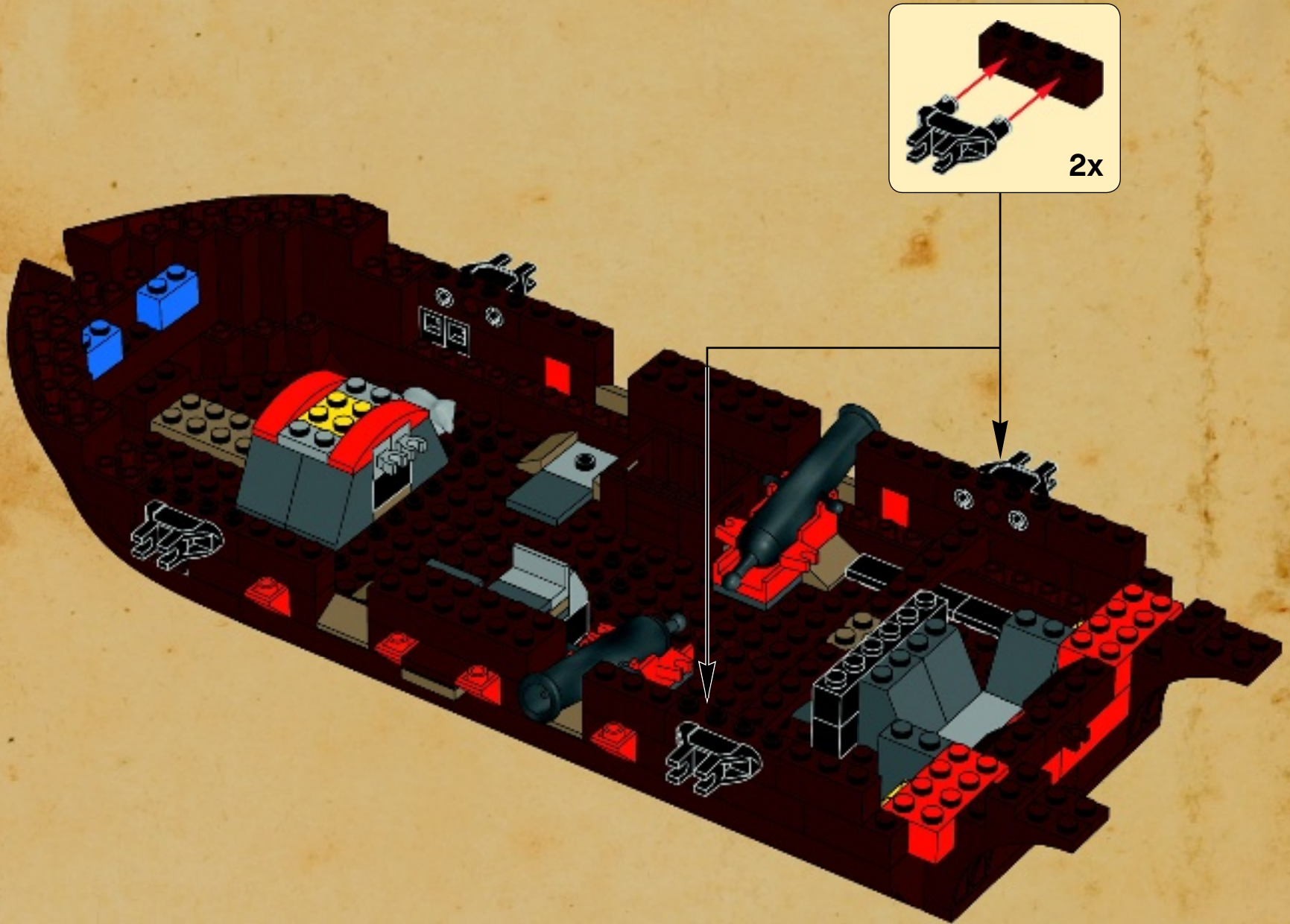



2x



1x

33

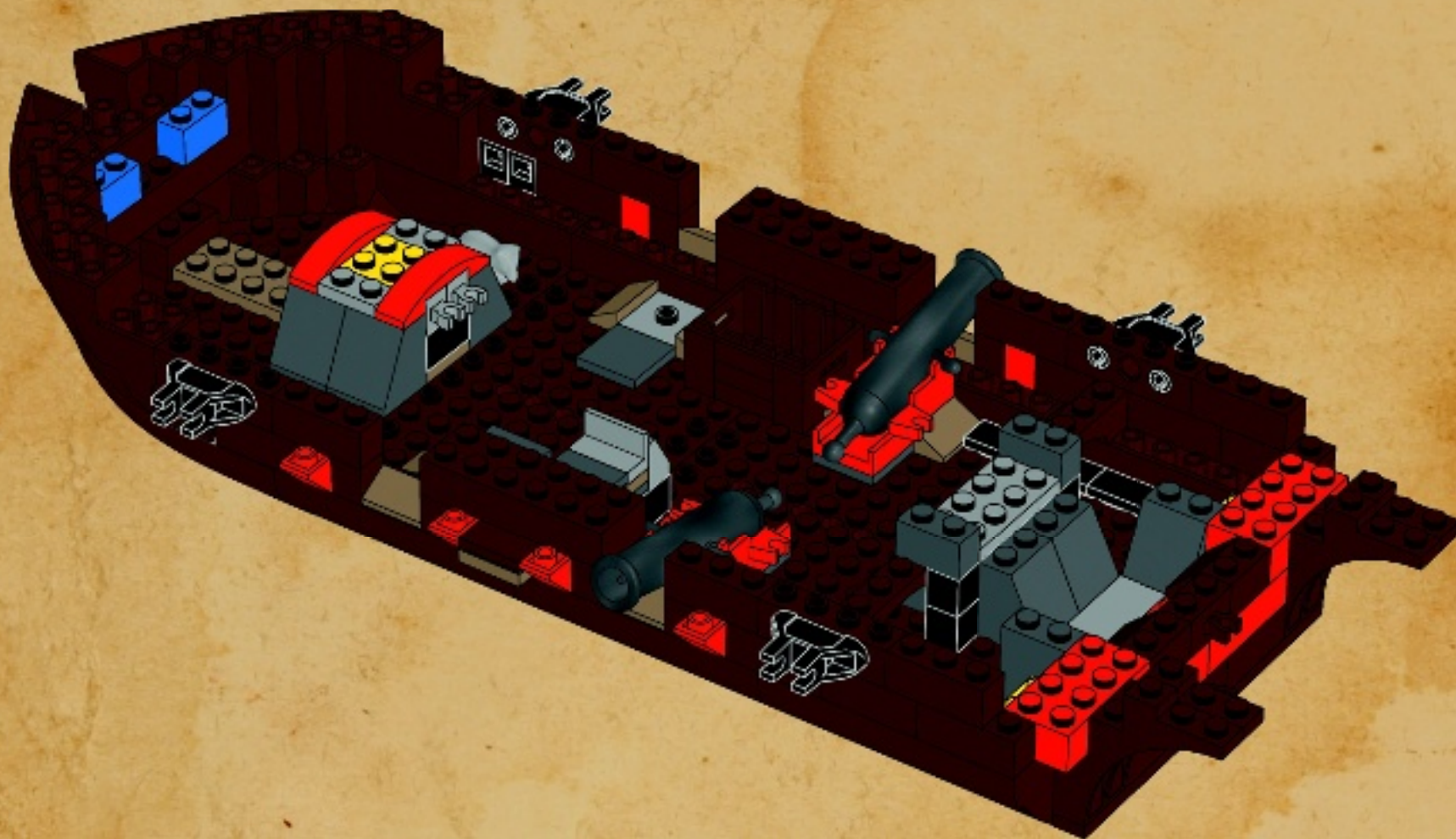



34

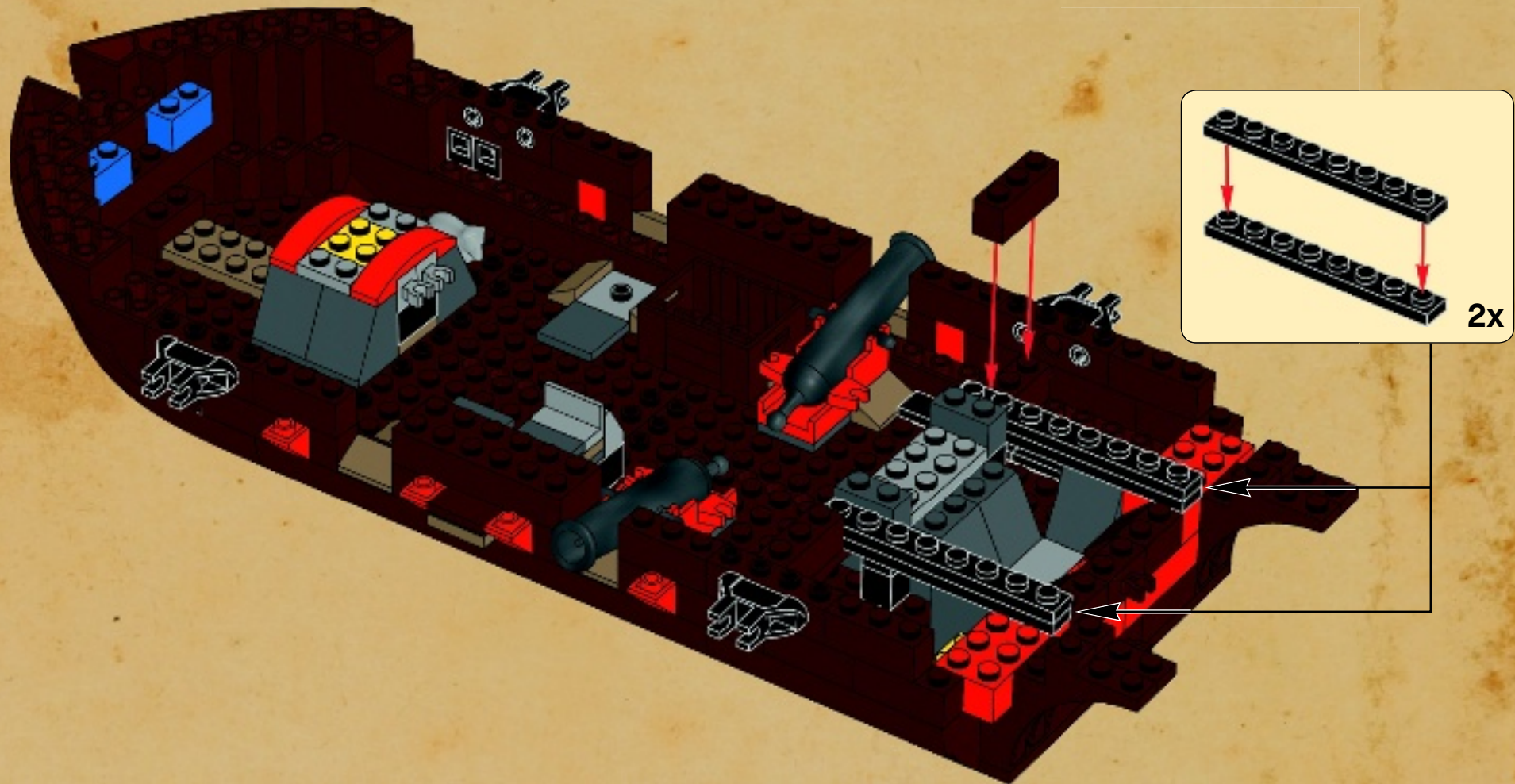

2x 4x 2x

# 35

2x

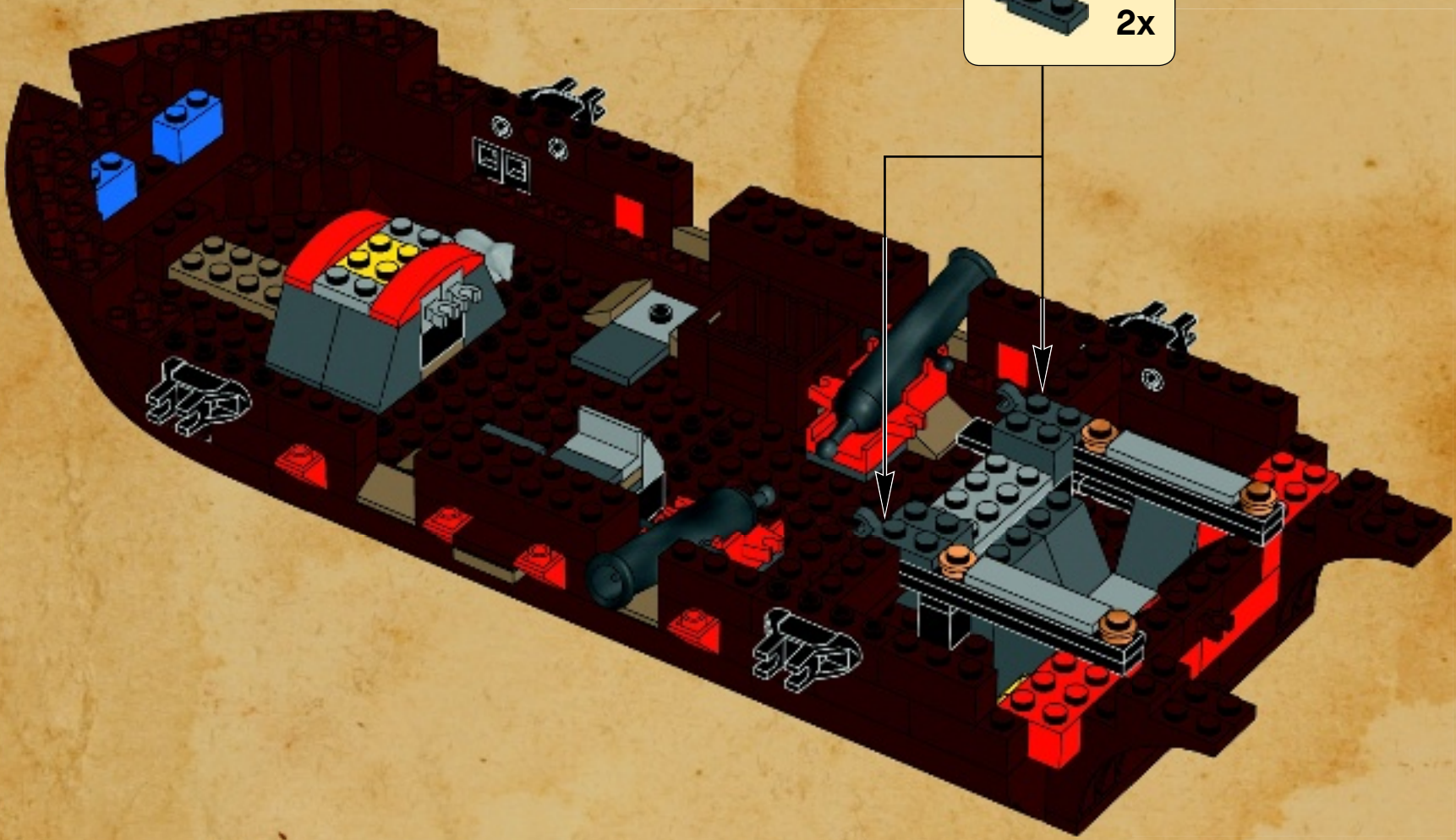



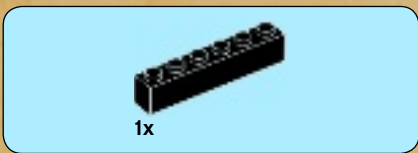

36

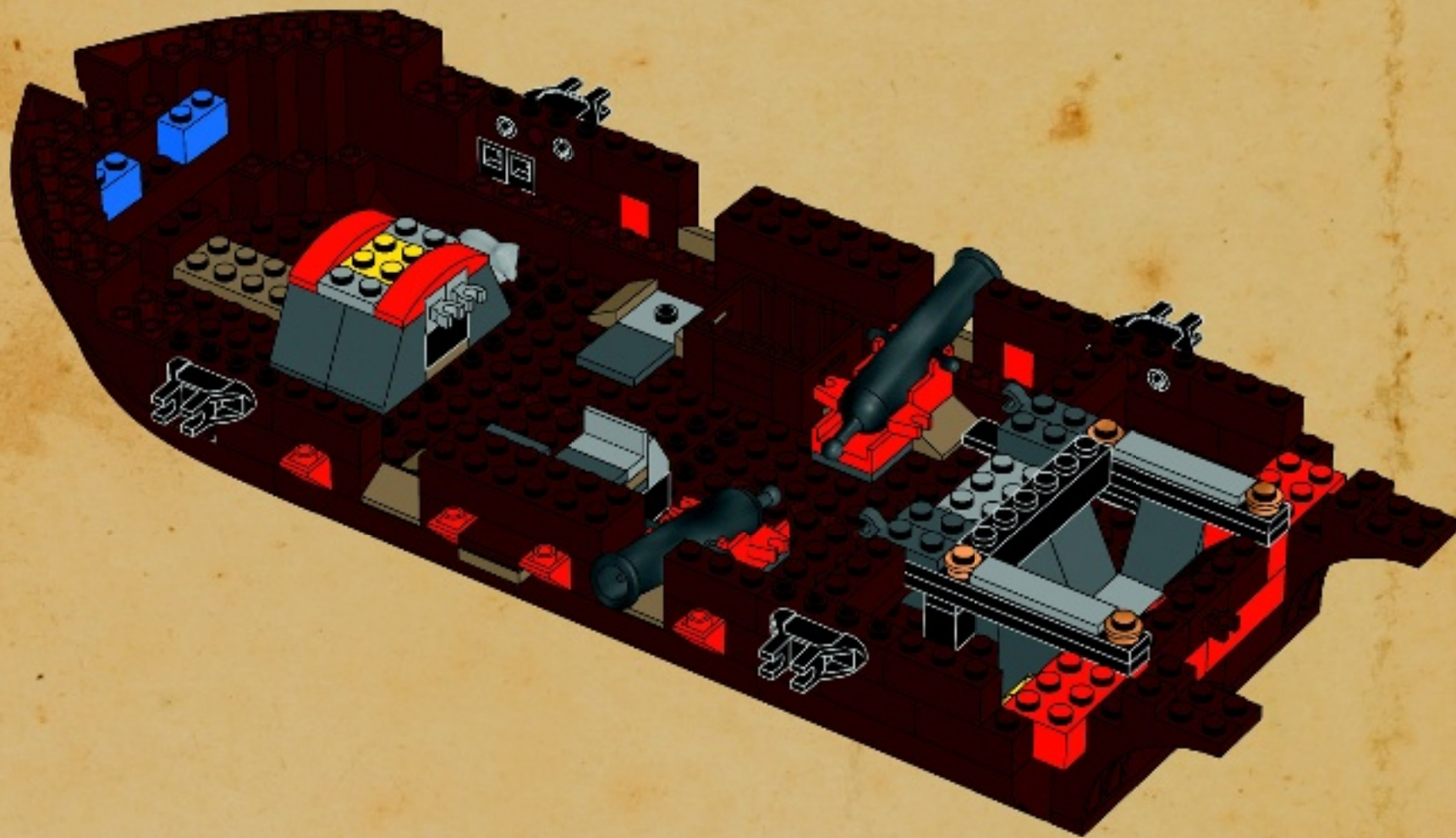



2x



2x

37

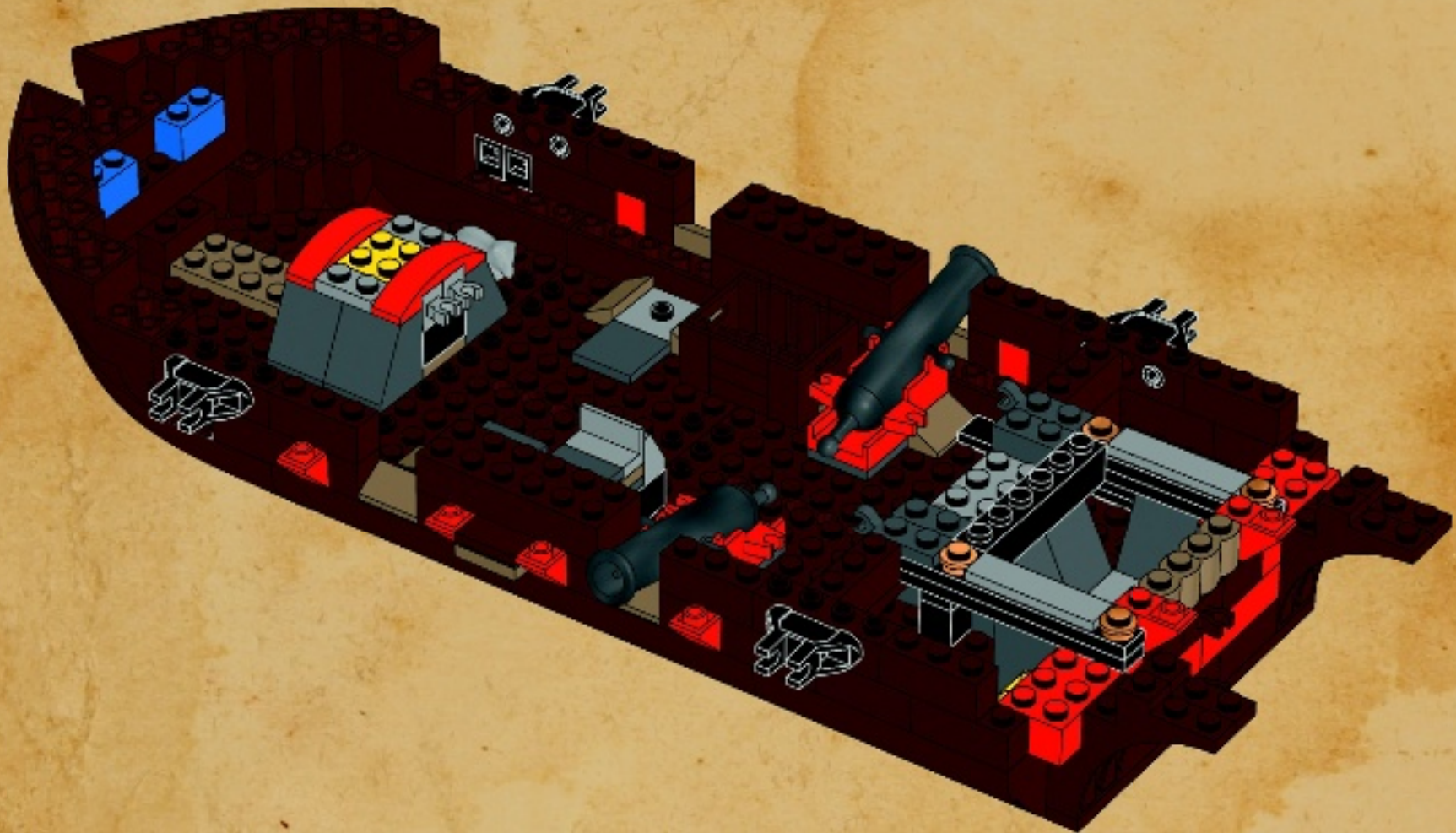



38

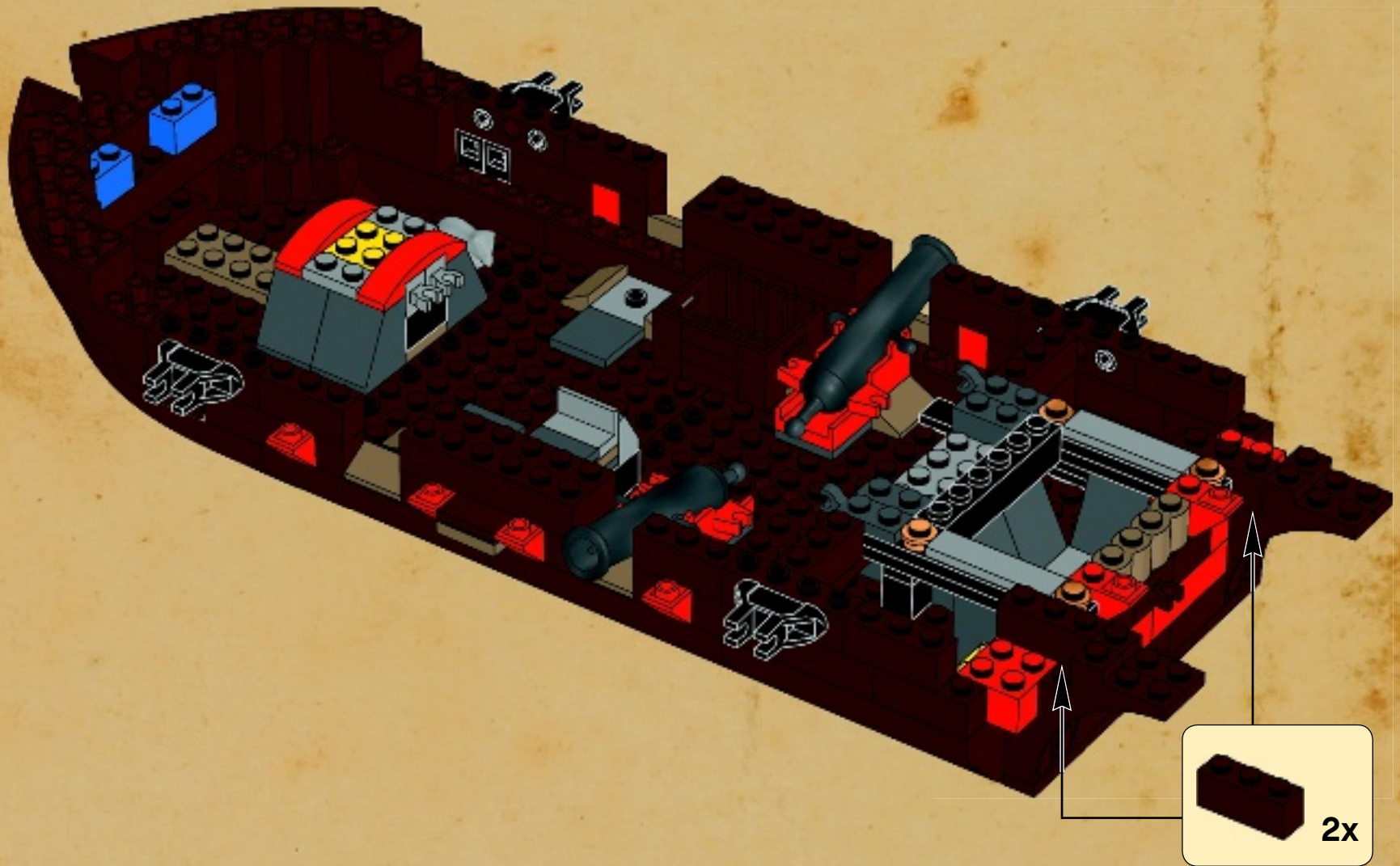



2x

39

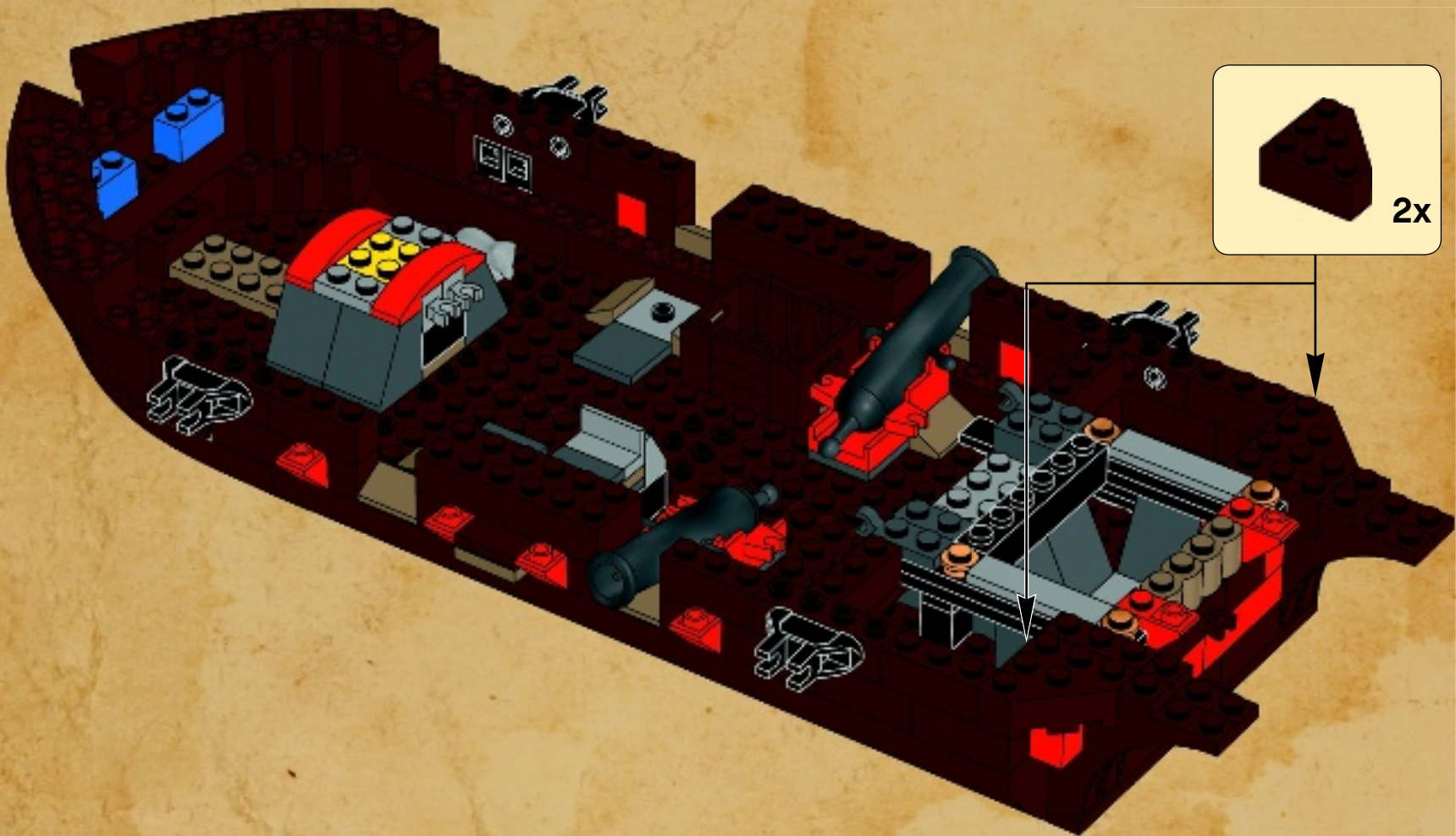

2x

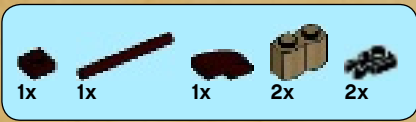

40

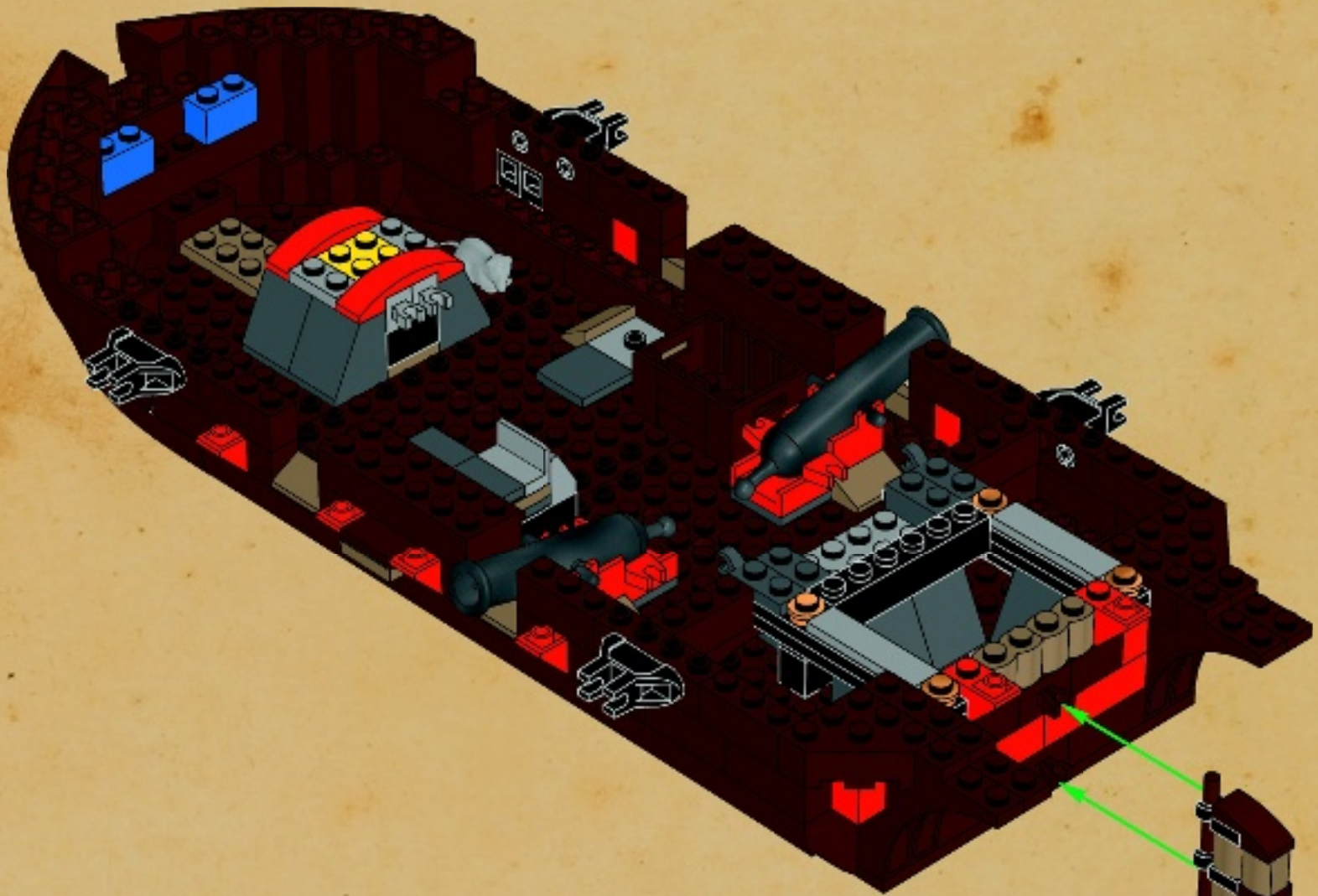
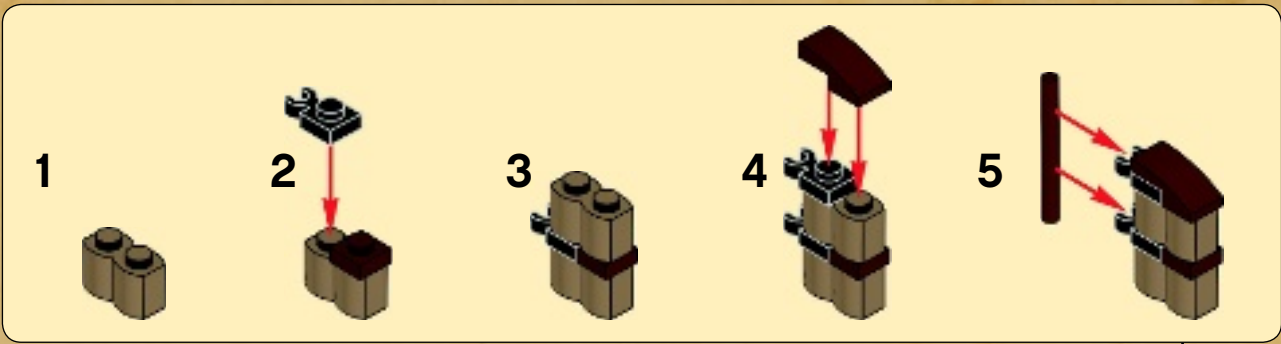

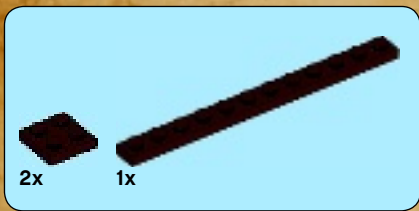

41

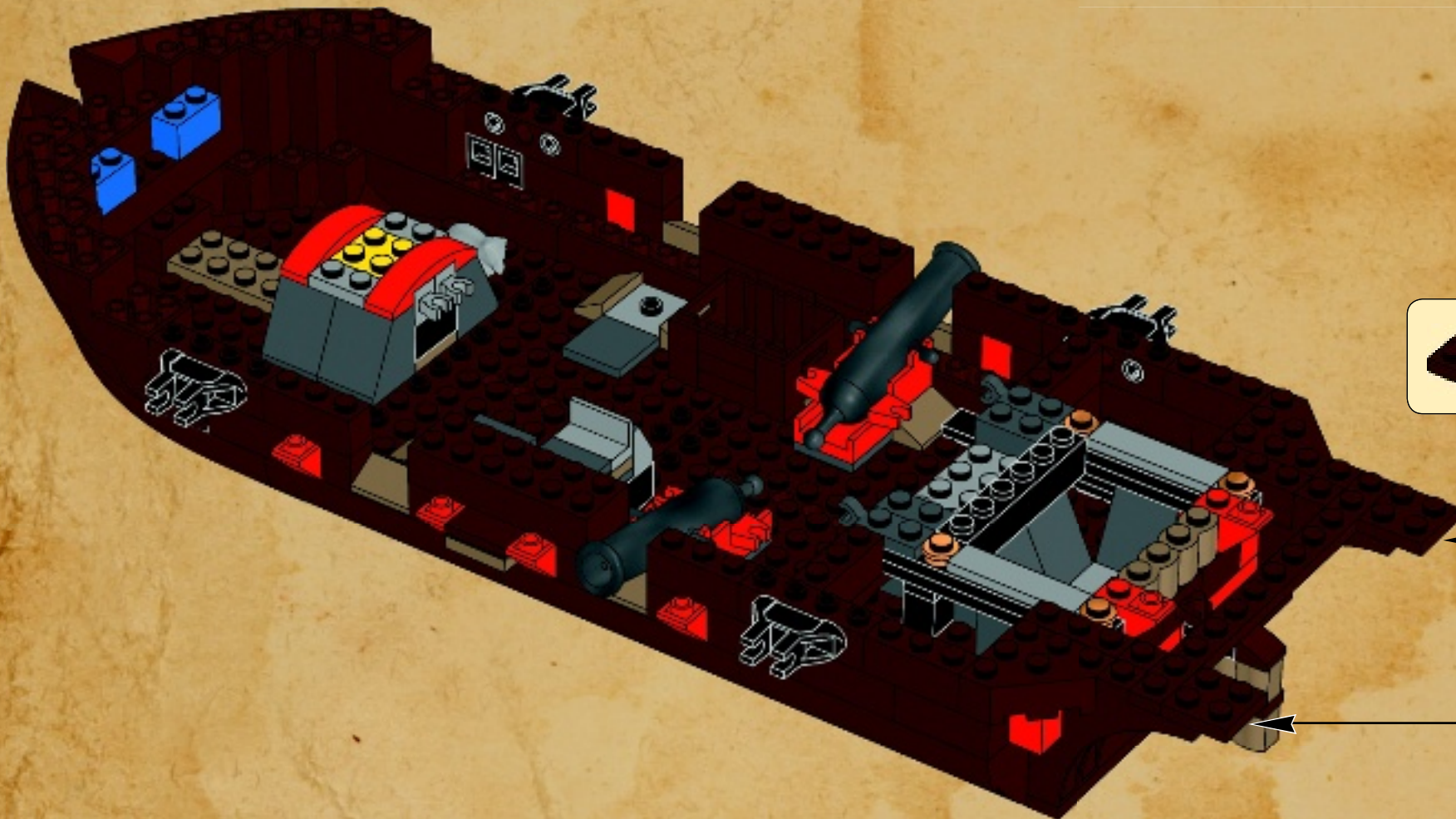

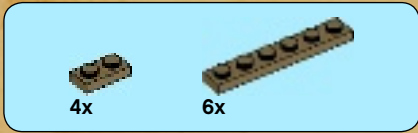
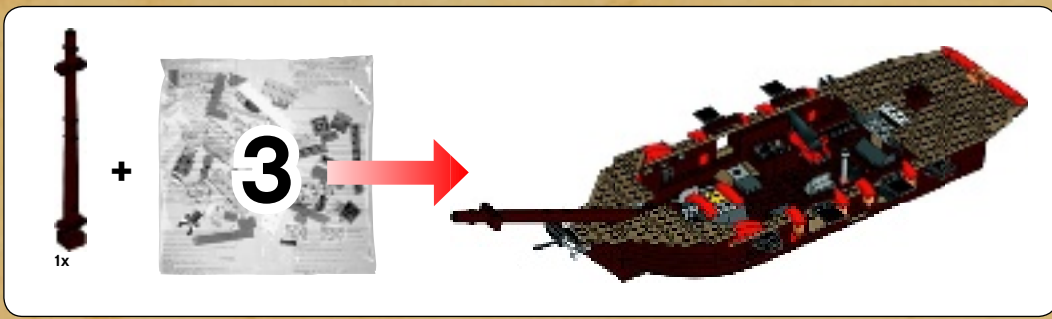

42

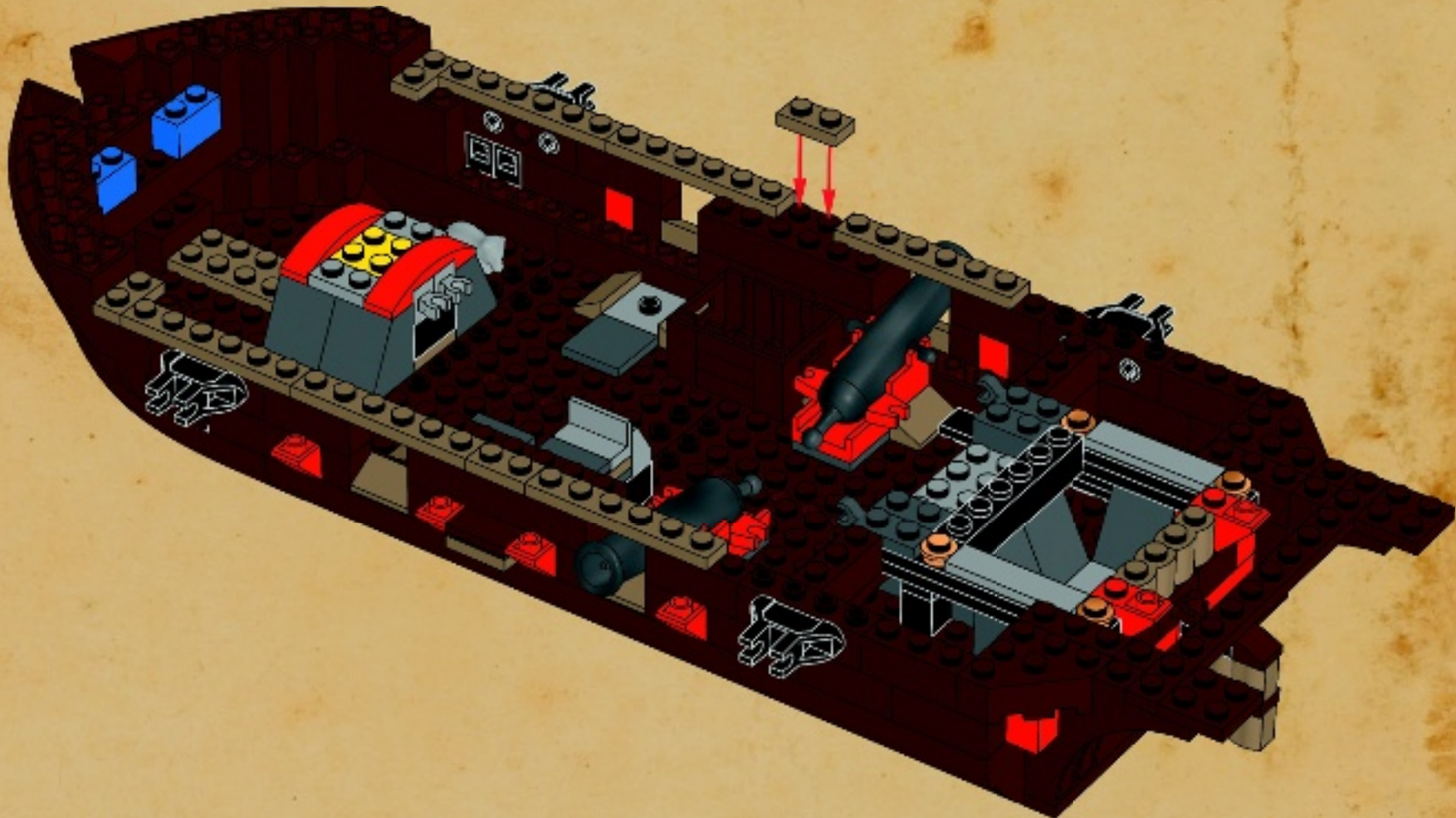



43

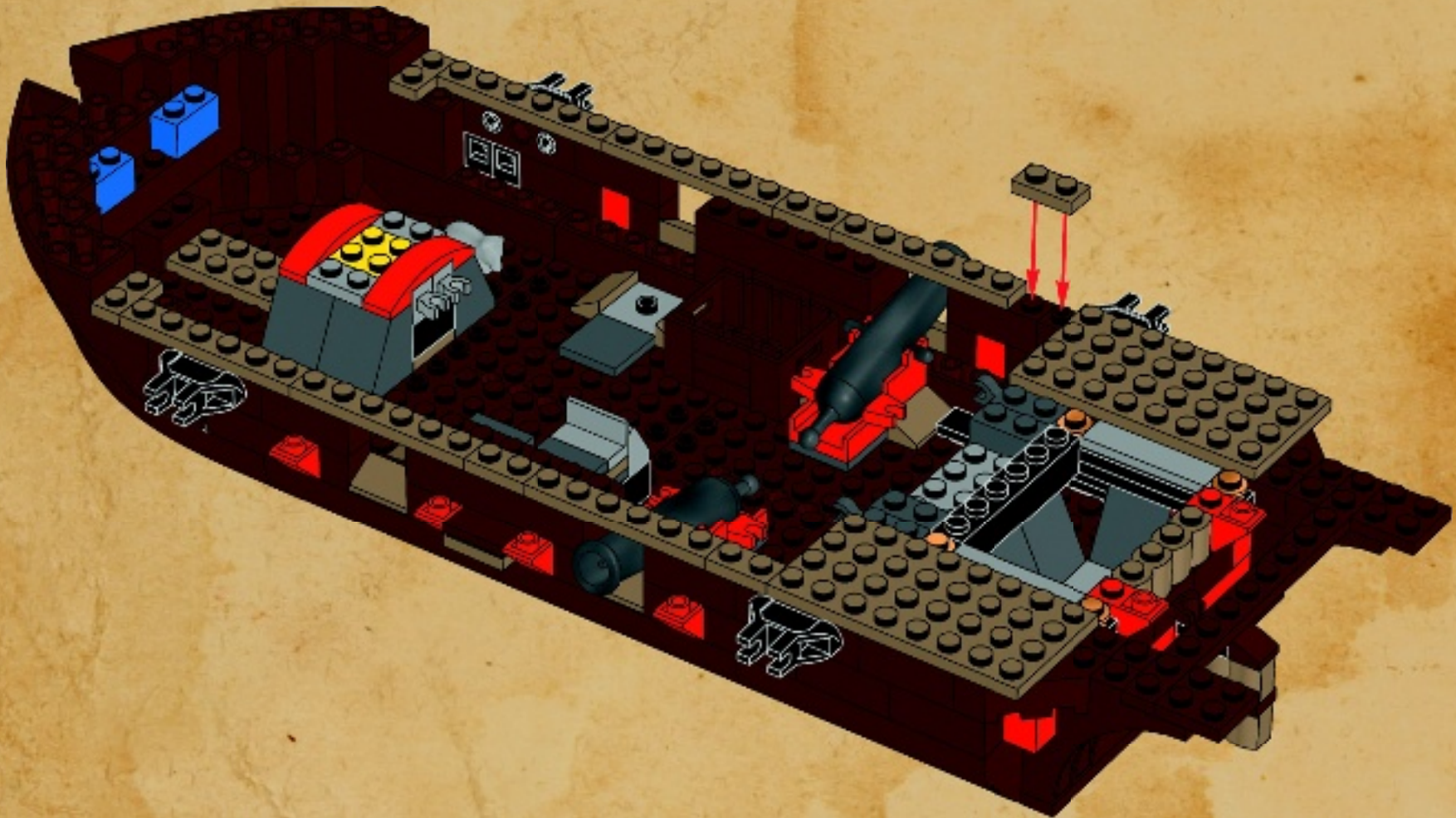





44

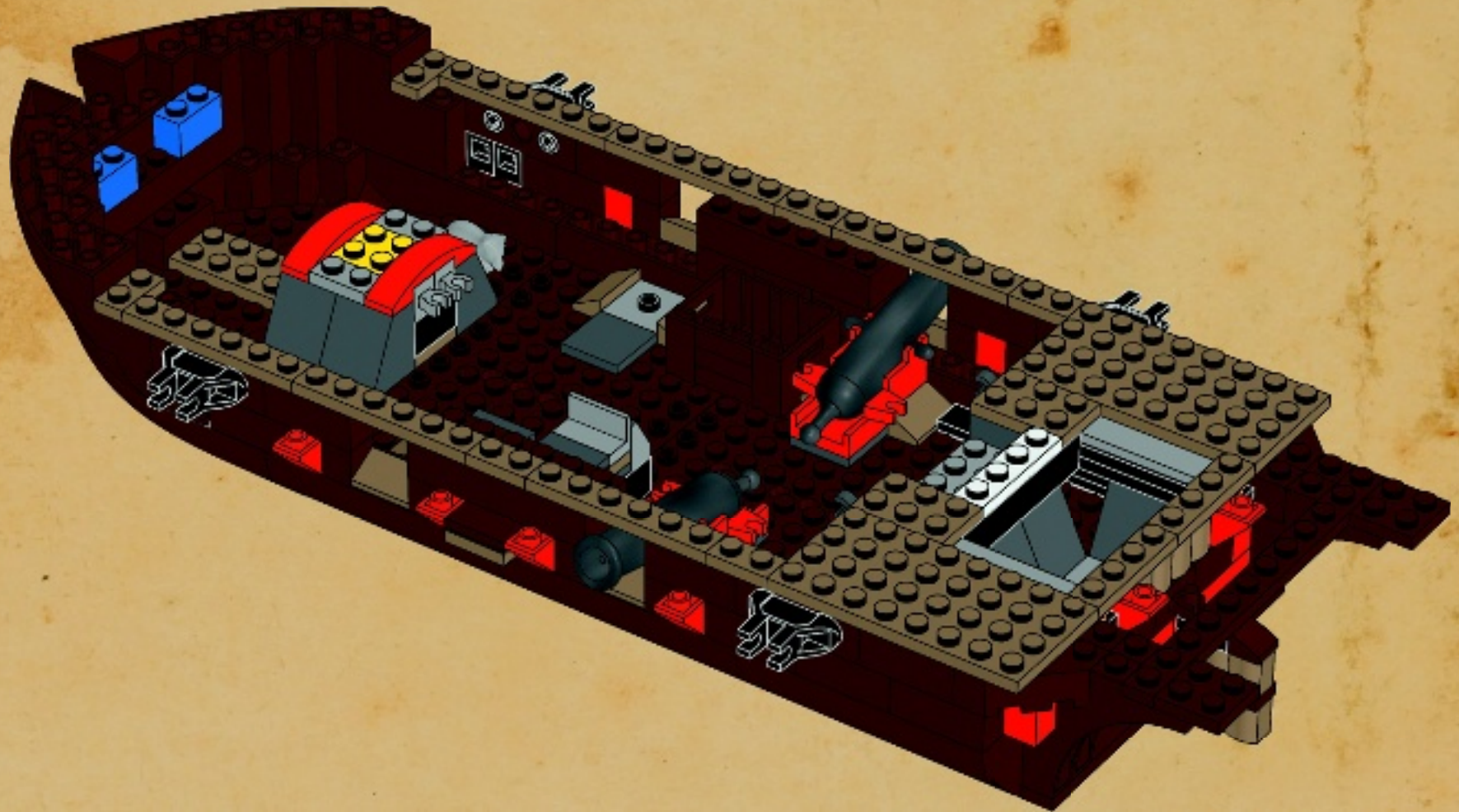

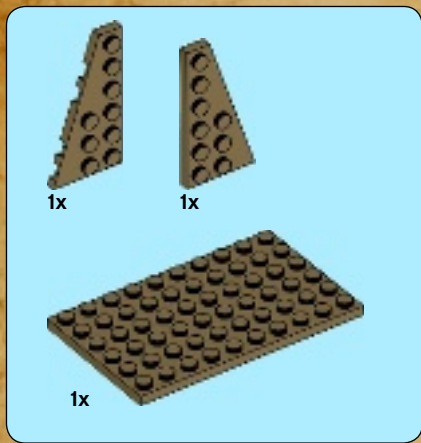

45

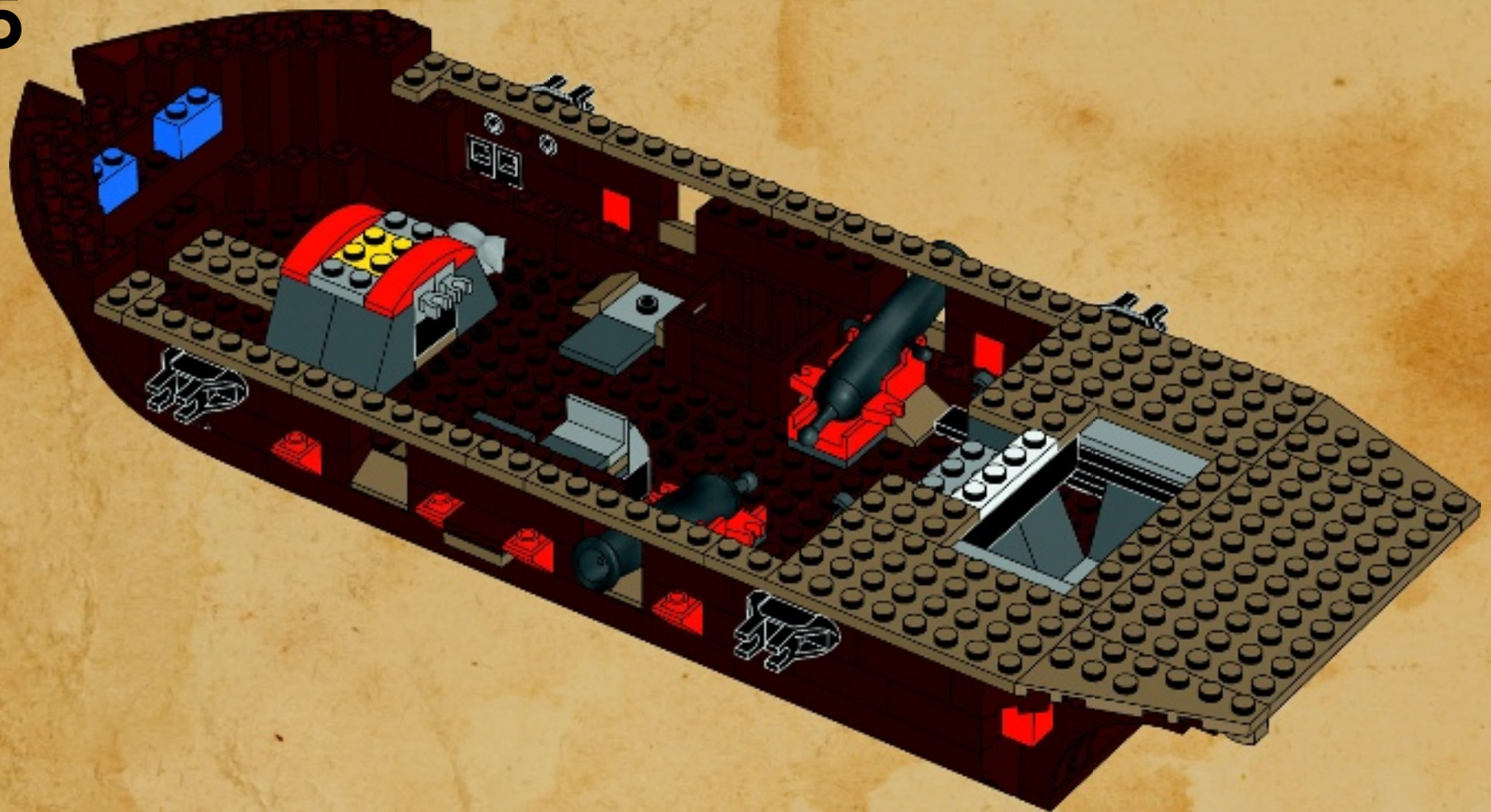



46

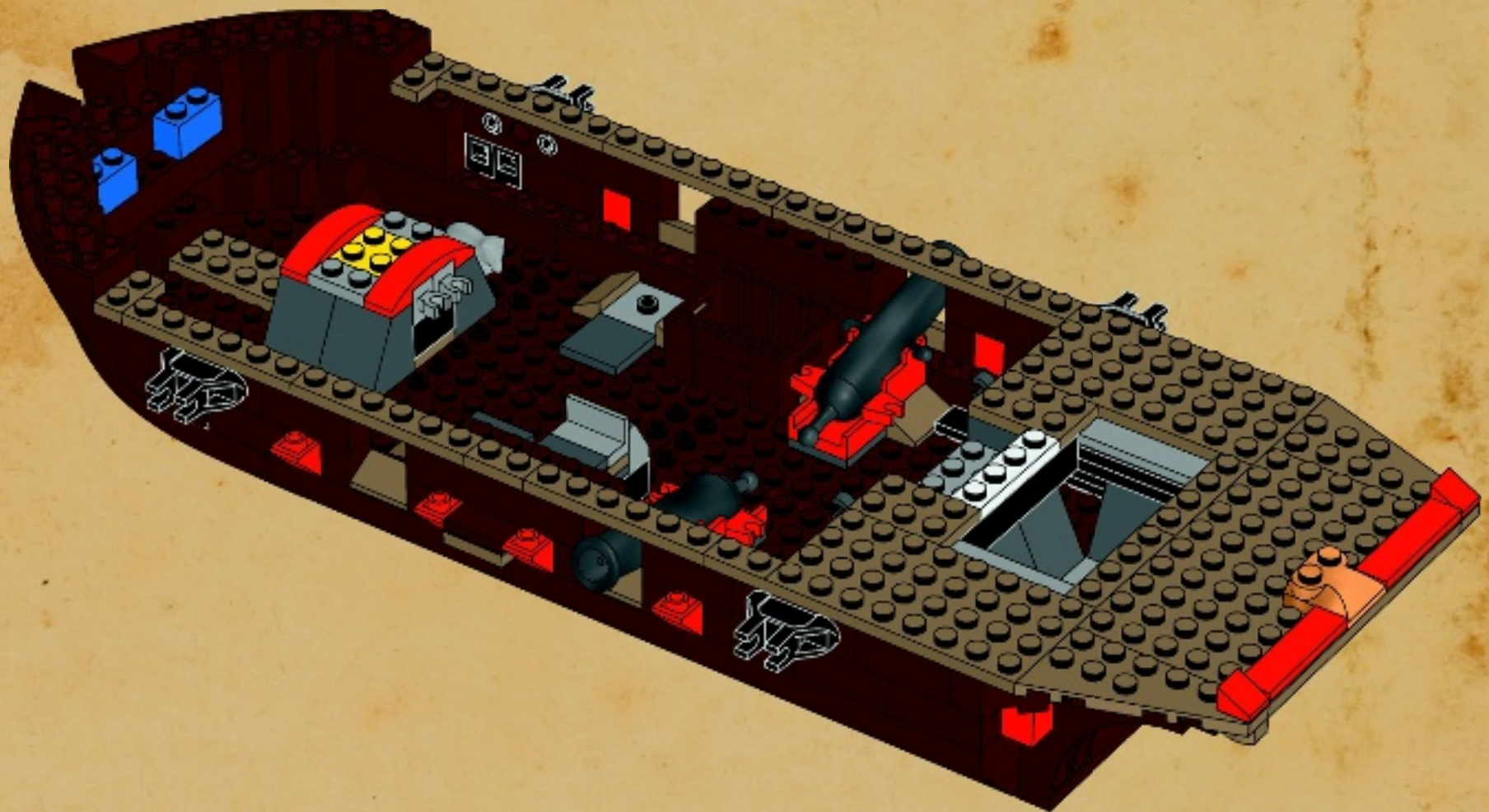



47

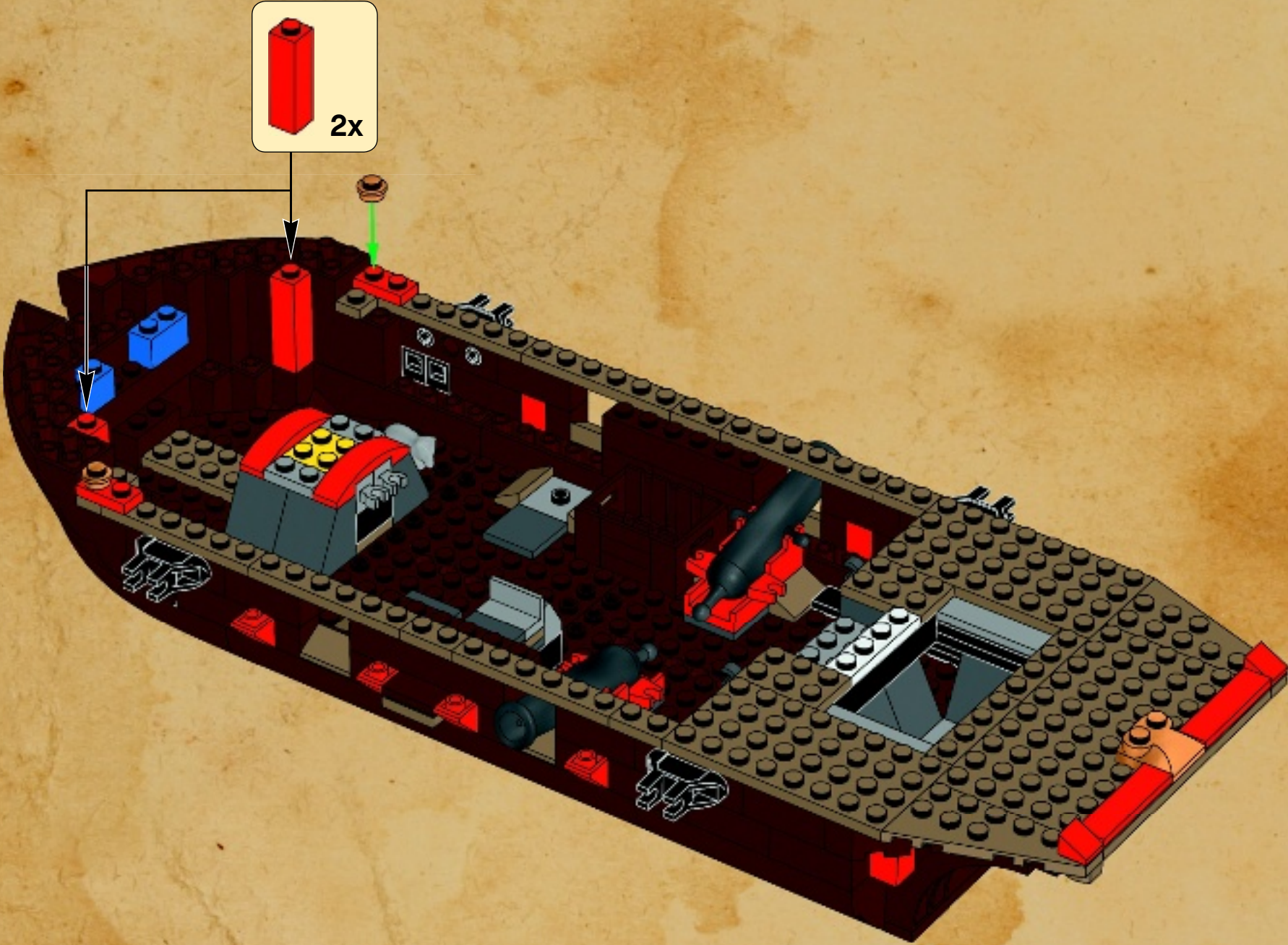
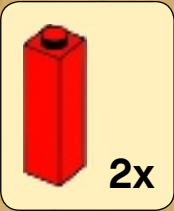



2x



8x

# 48

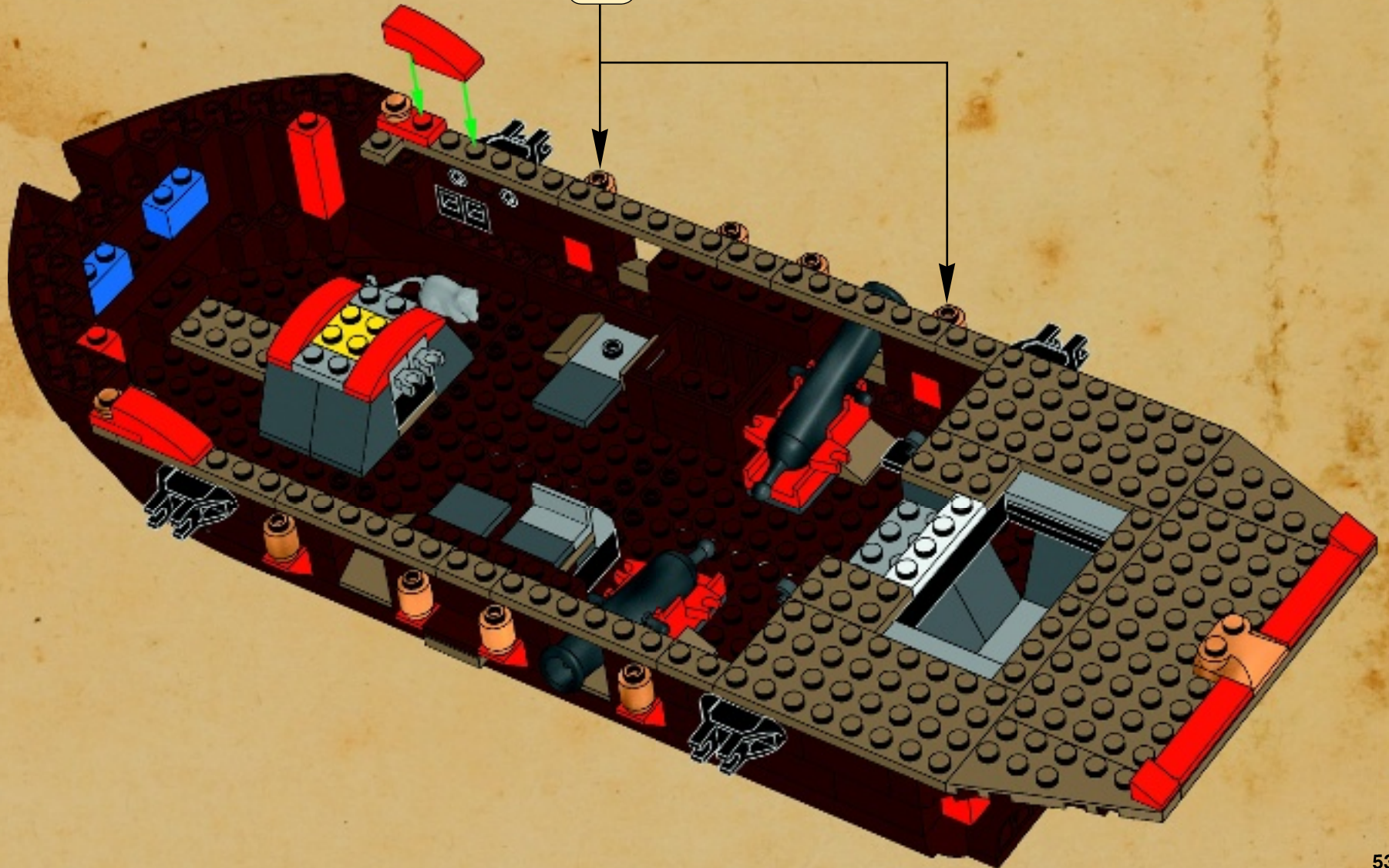



2x



4x



4x

# 49

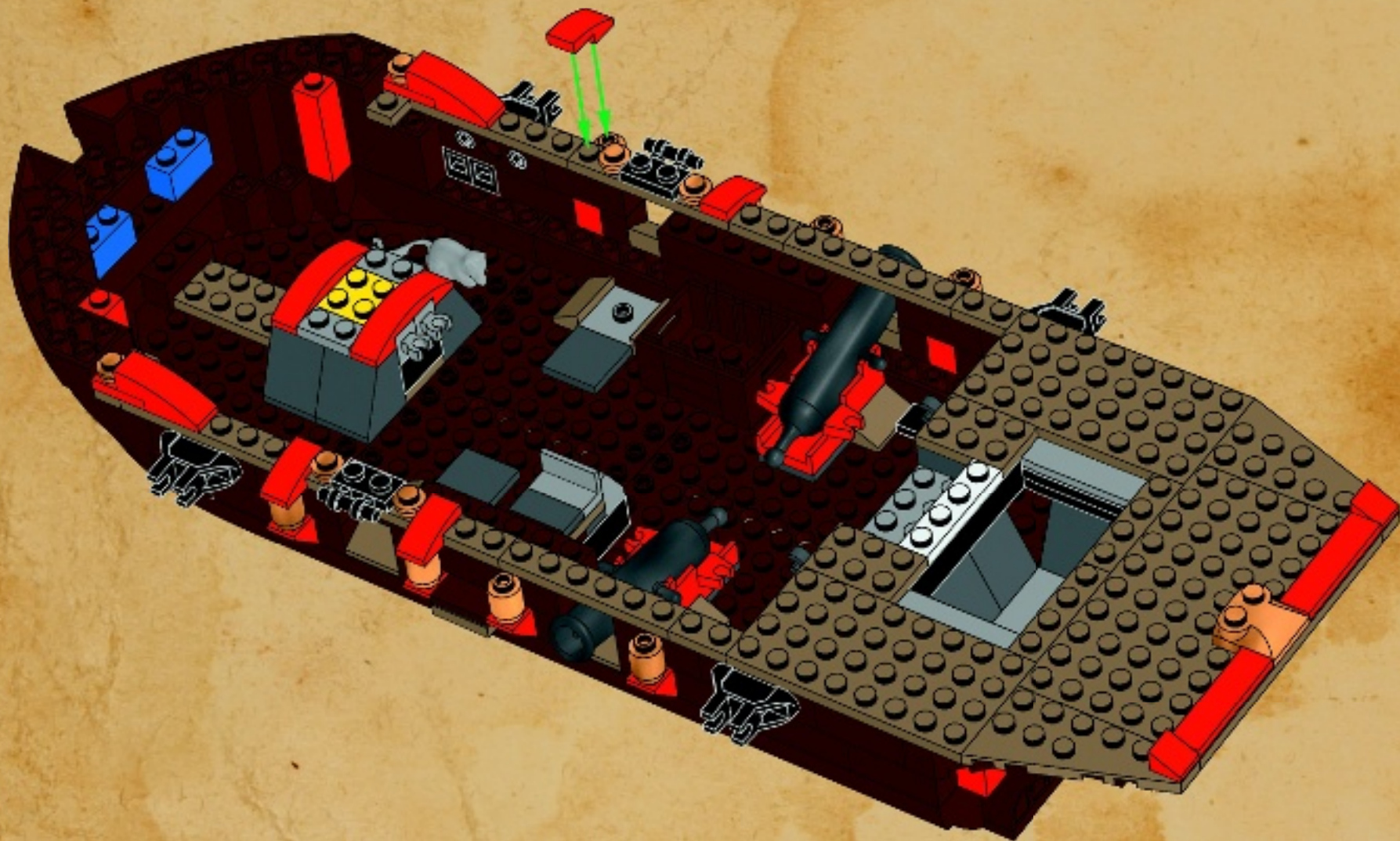

2x  
4x  
4x

50

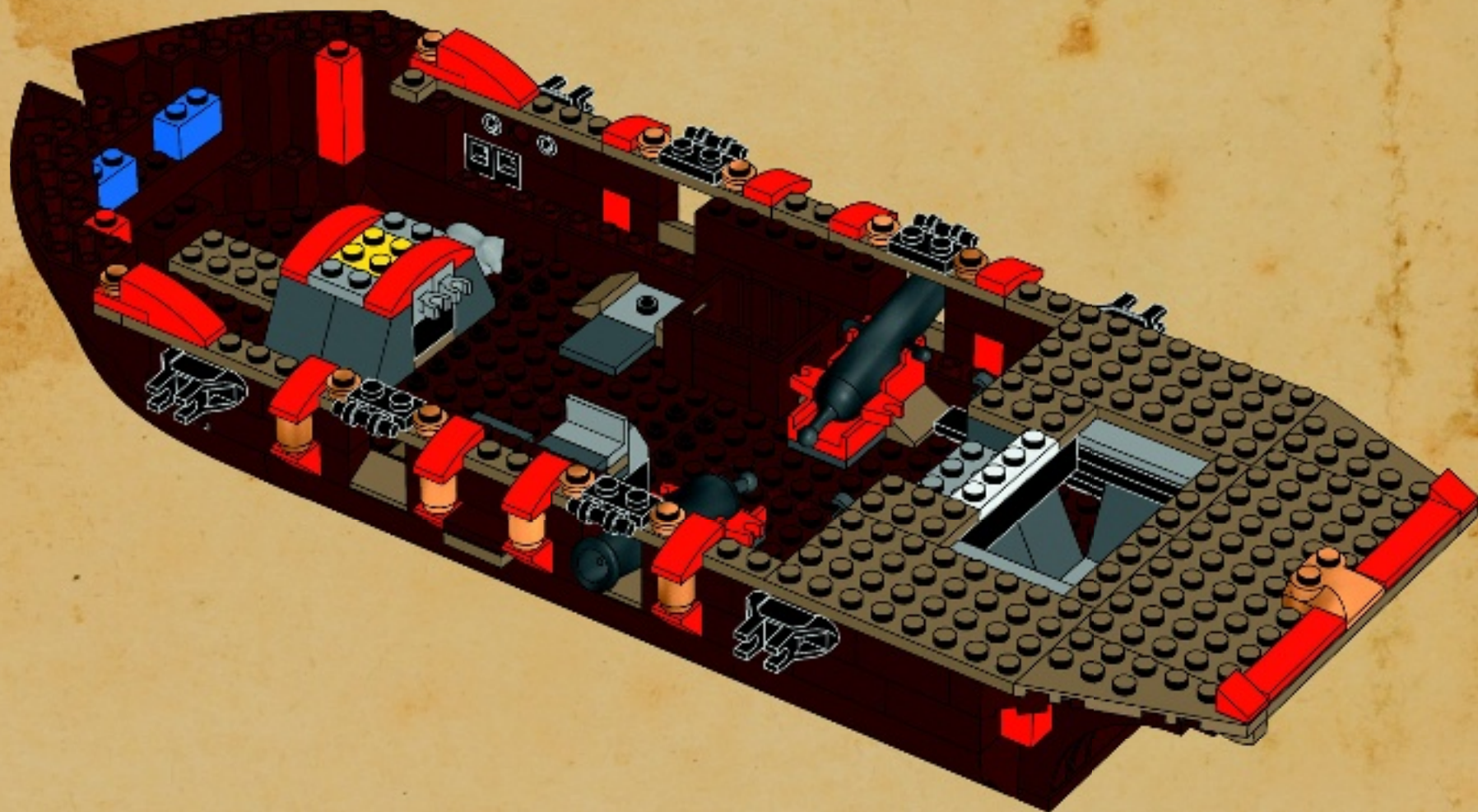

4x



51

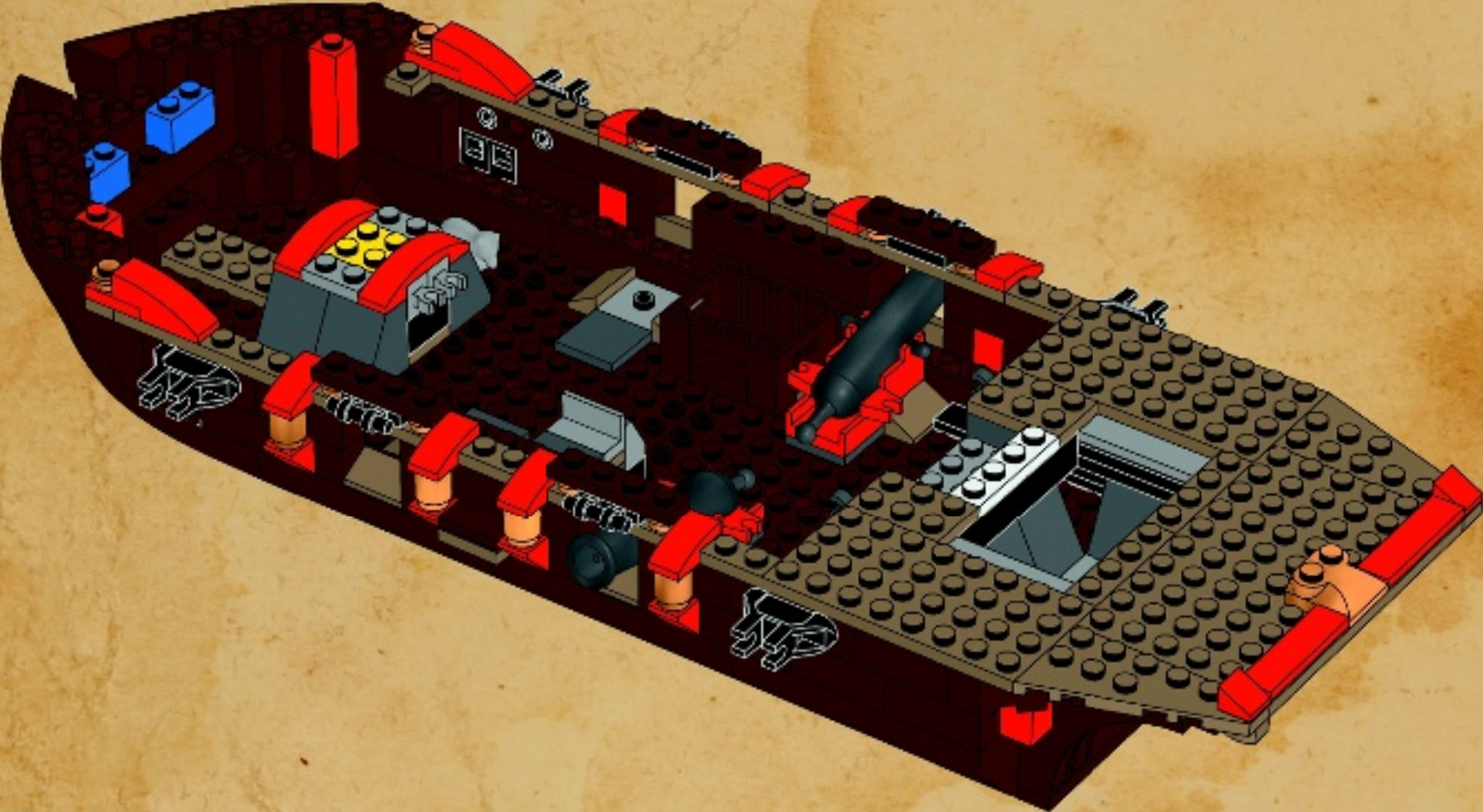





4x

# 52

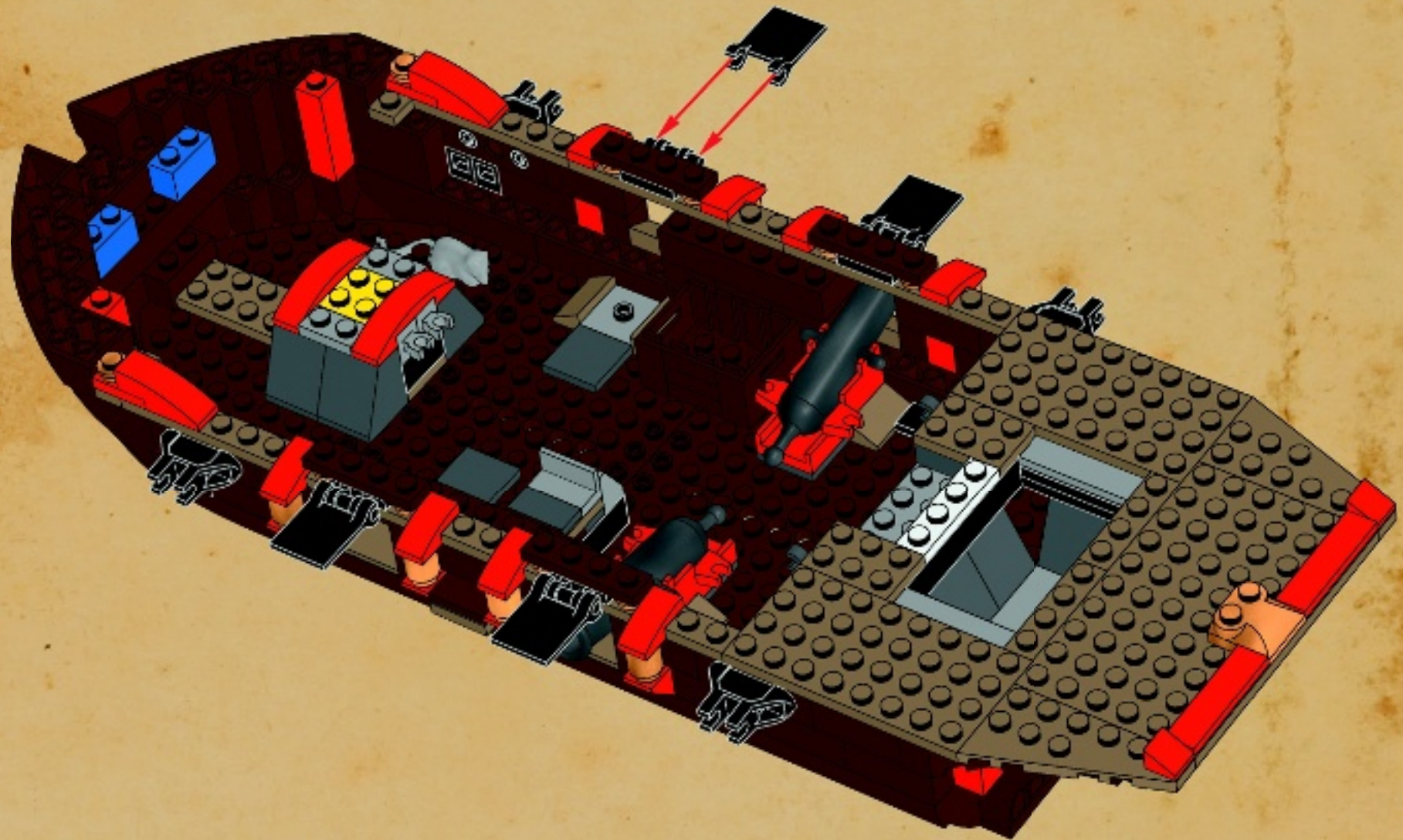

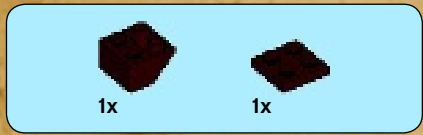

1



2



3



4





5



6

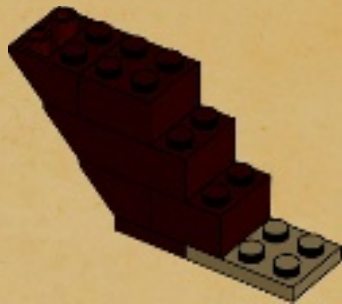

7



8

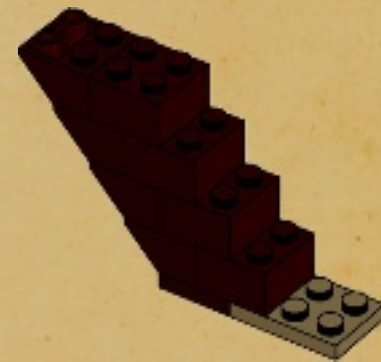

53

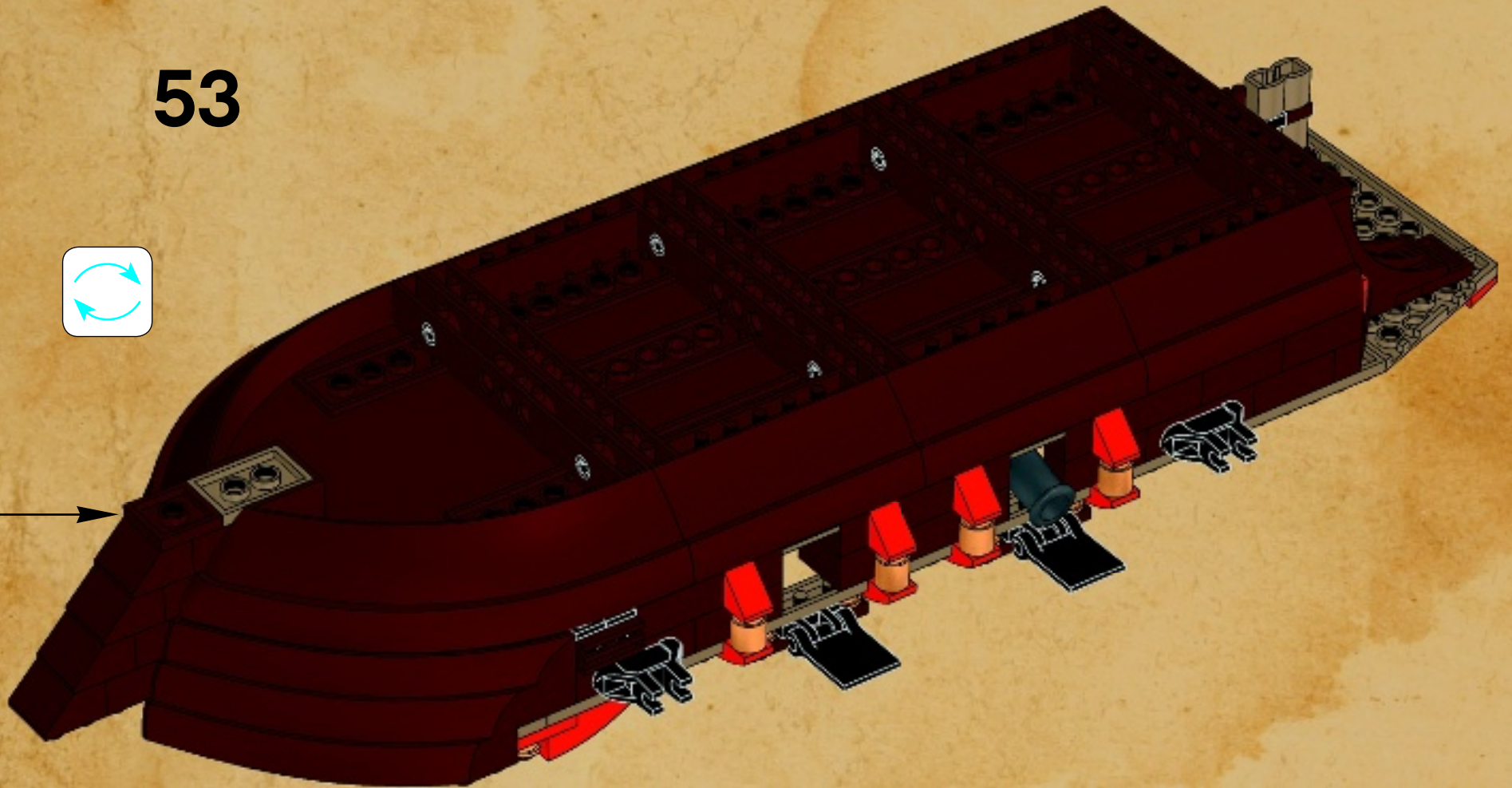



9x

# 54

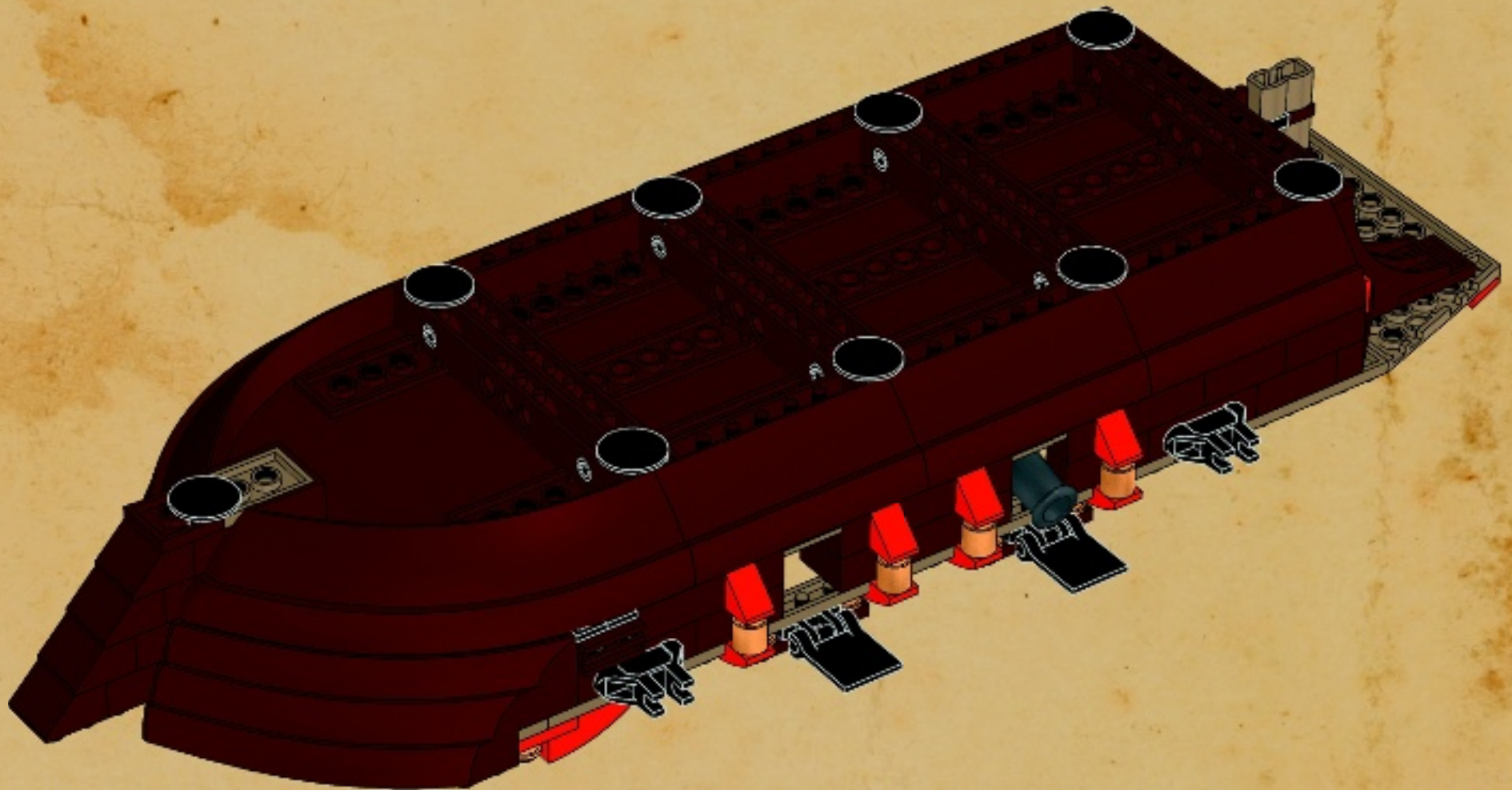

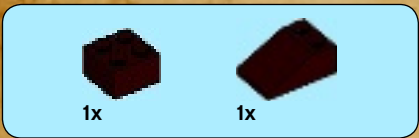

55

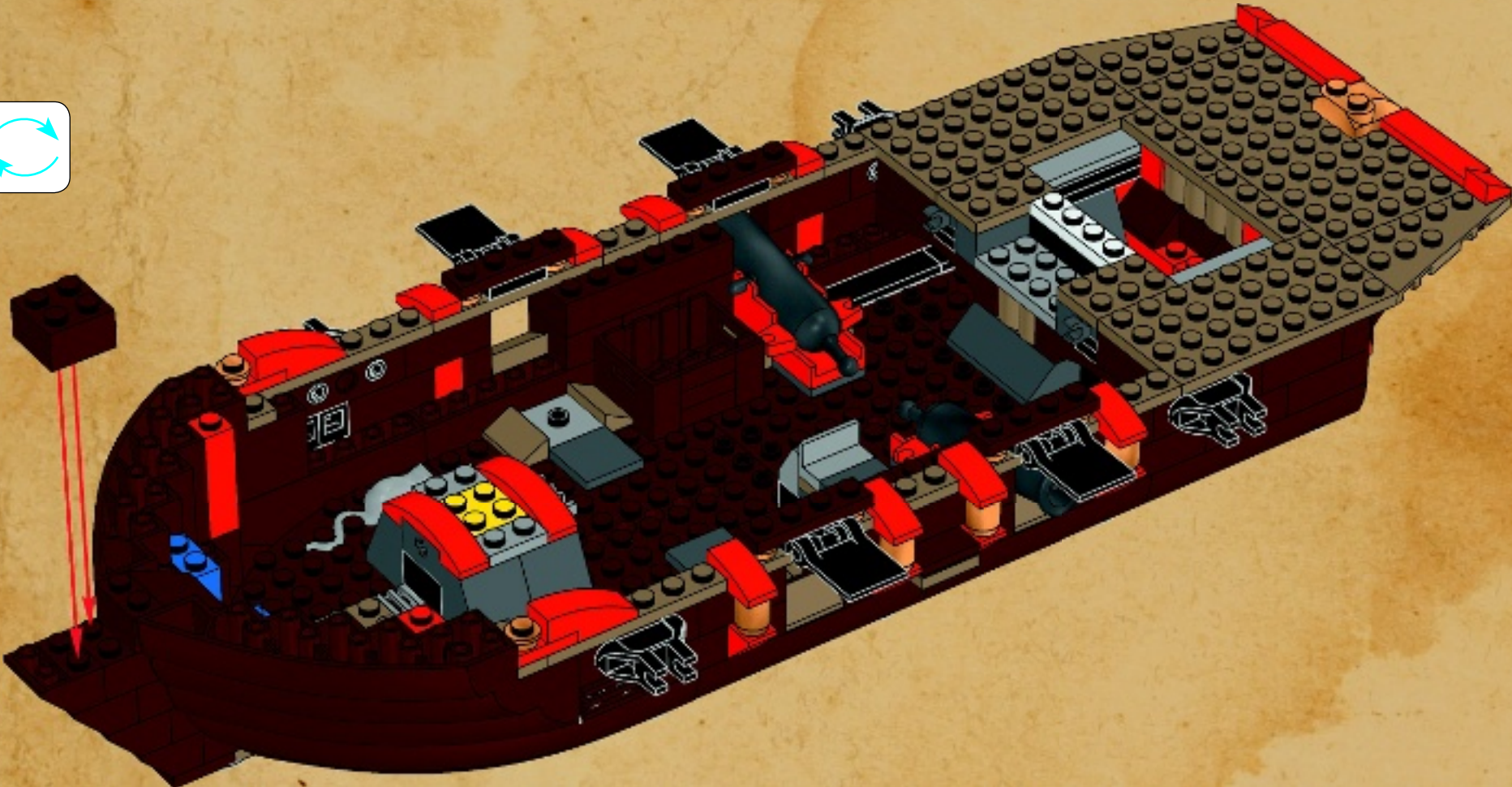

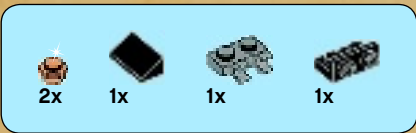

# 56

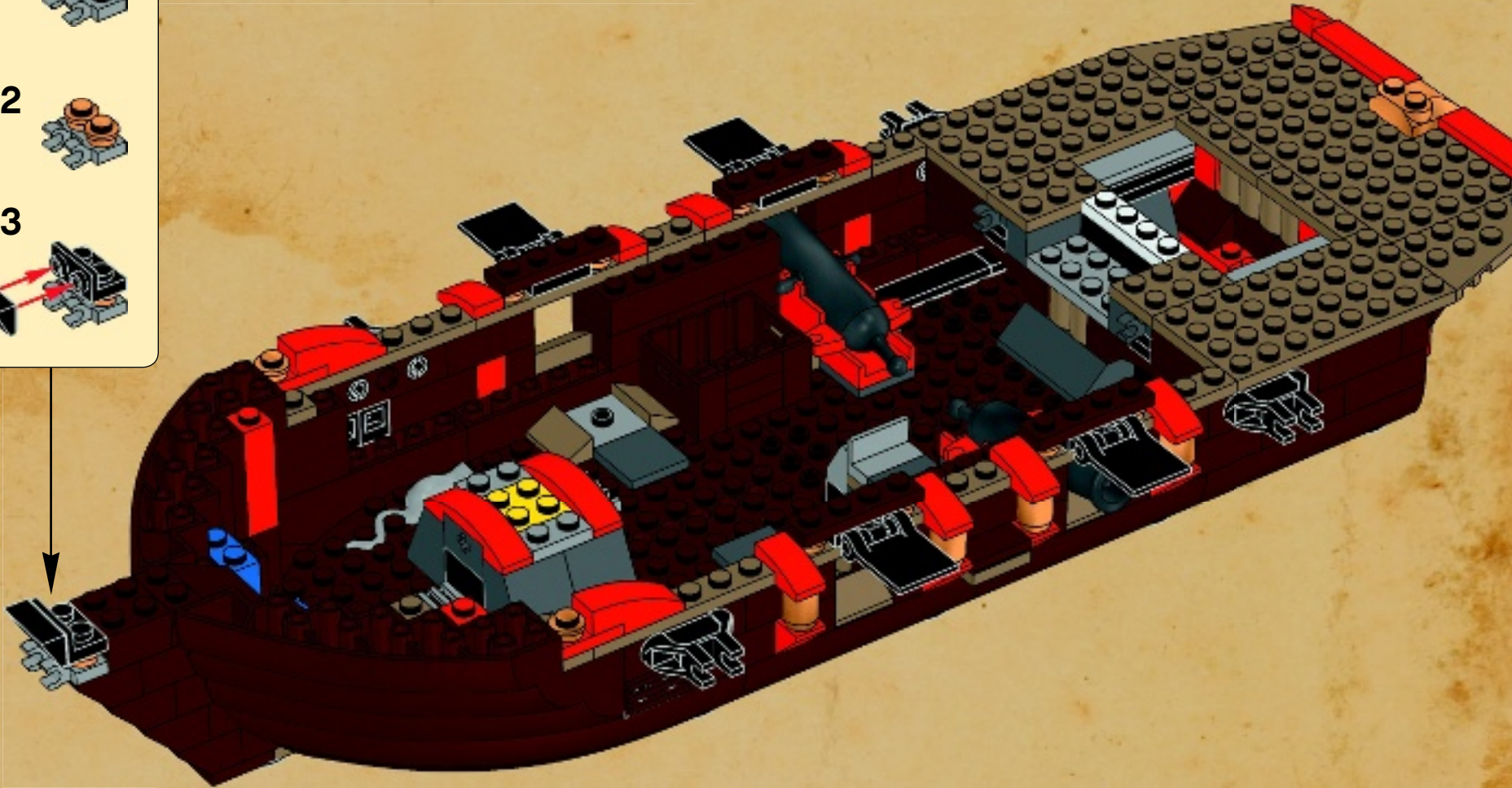



57

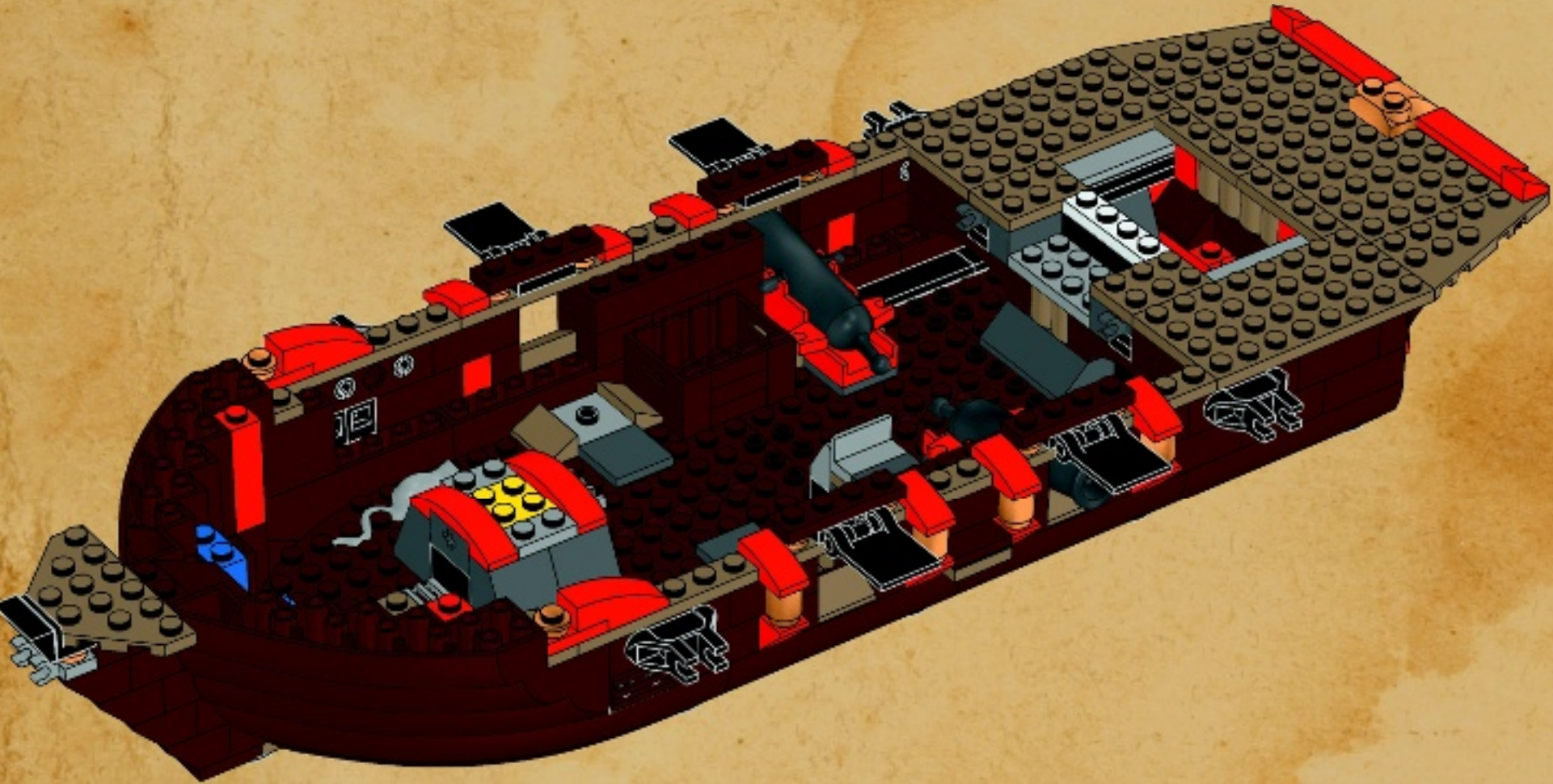



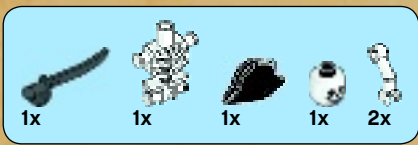

58

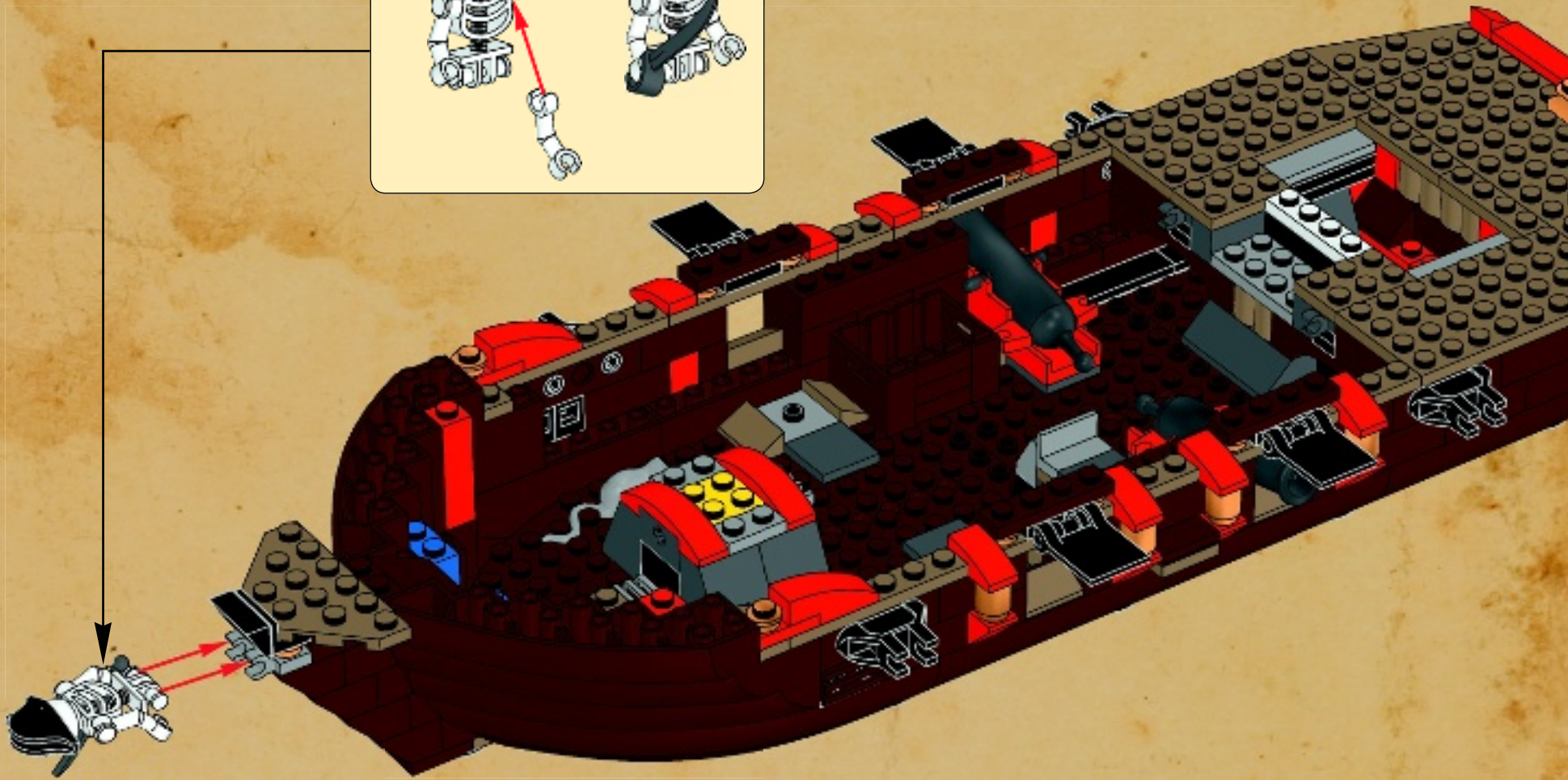
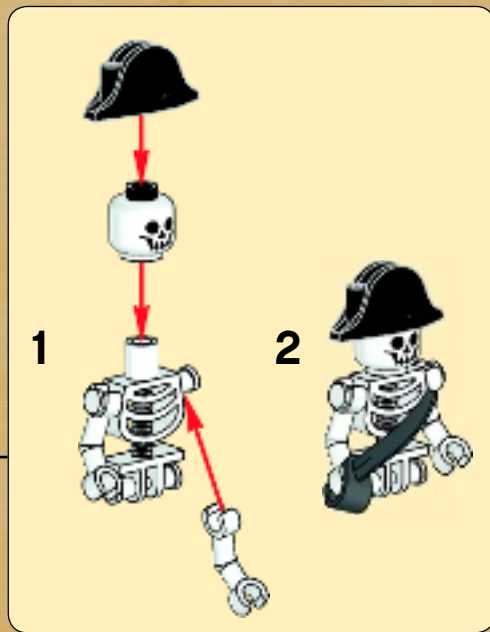

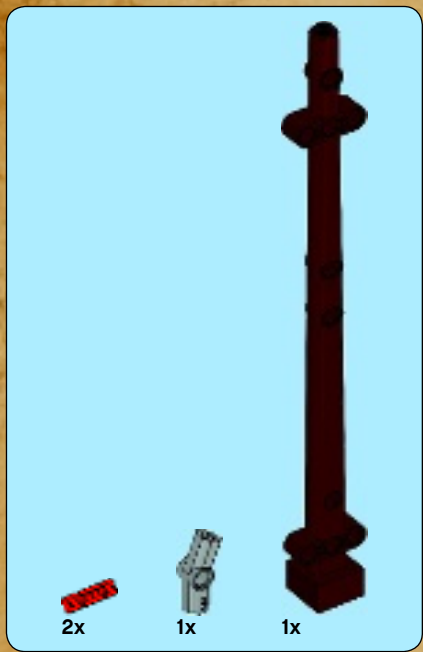

59

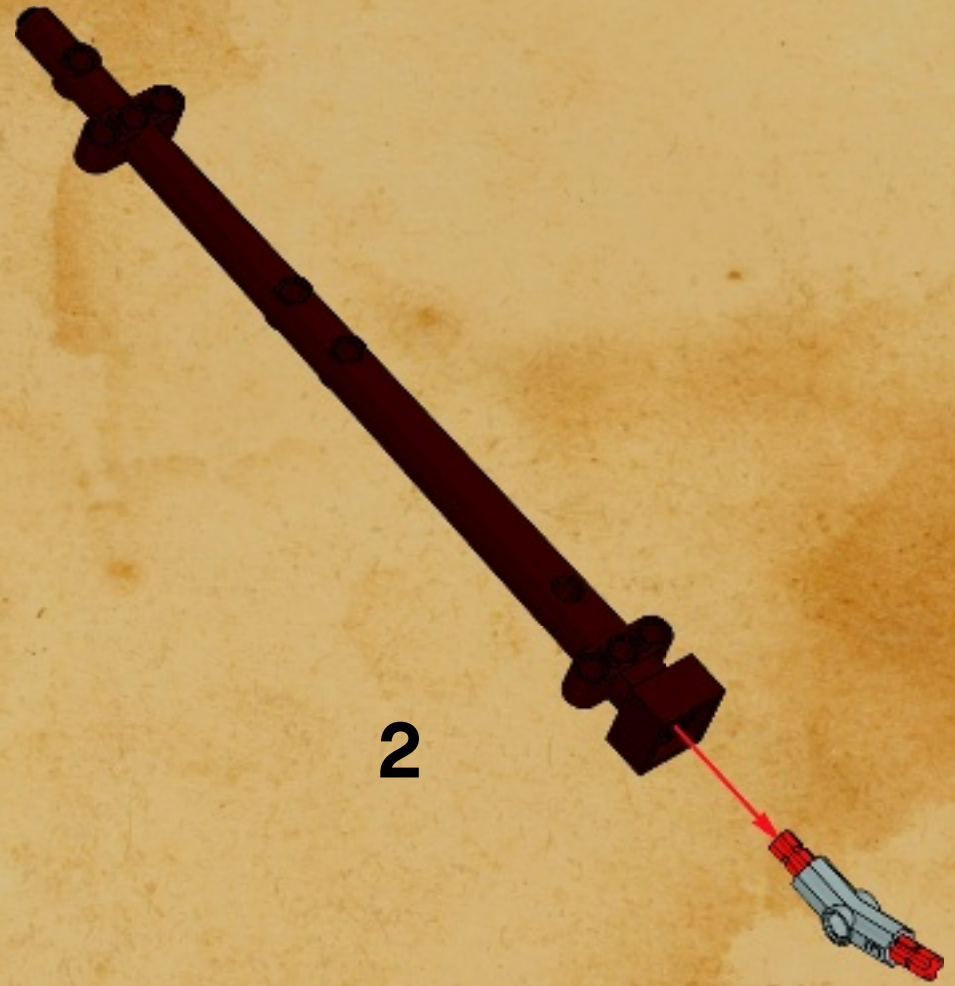
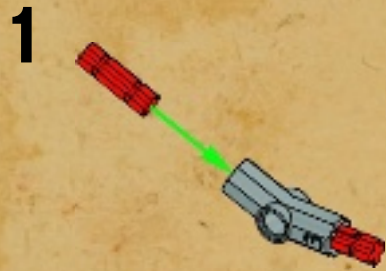

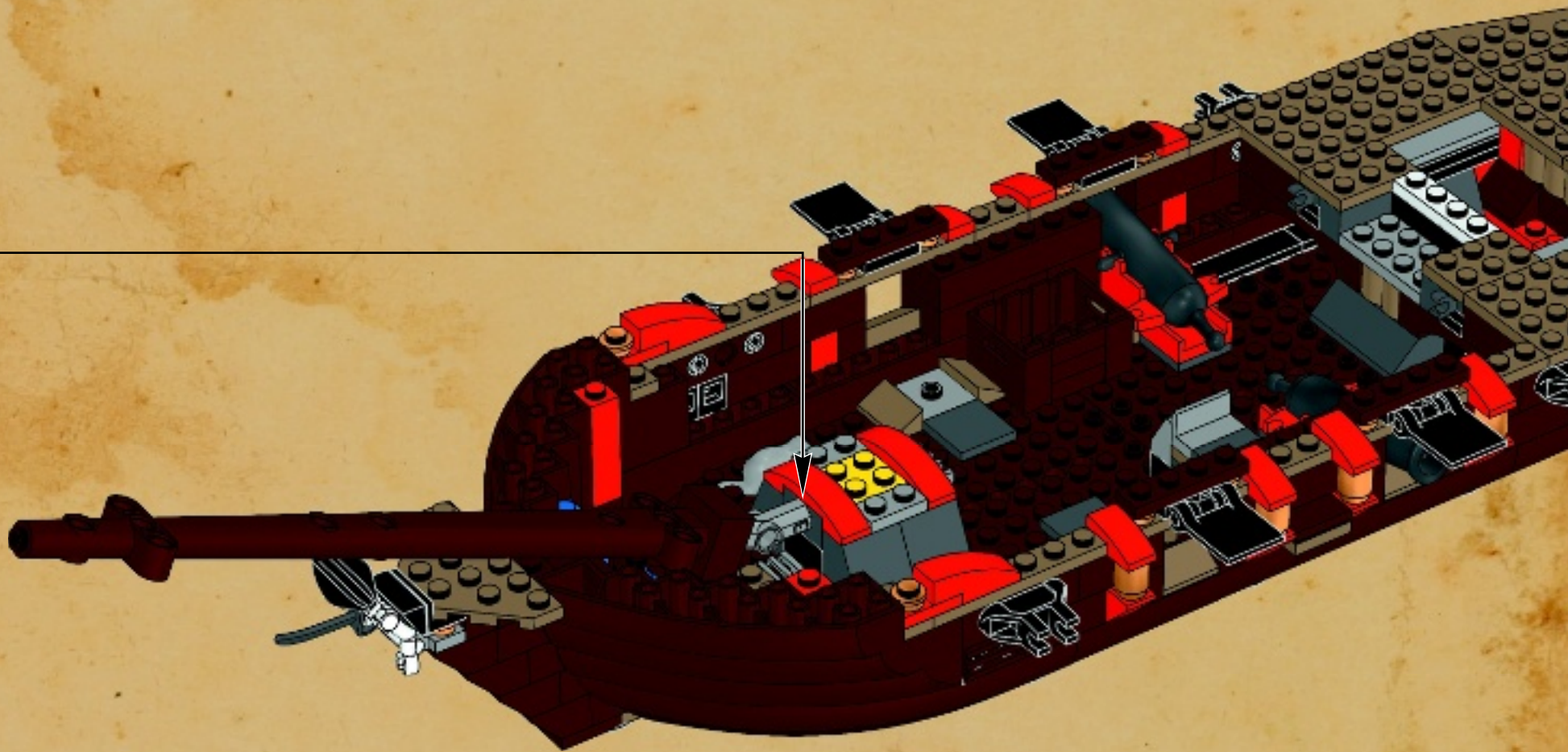

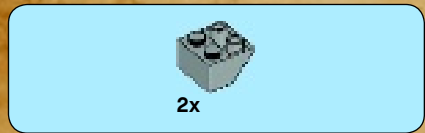

60

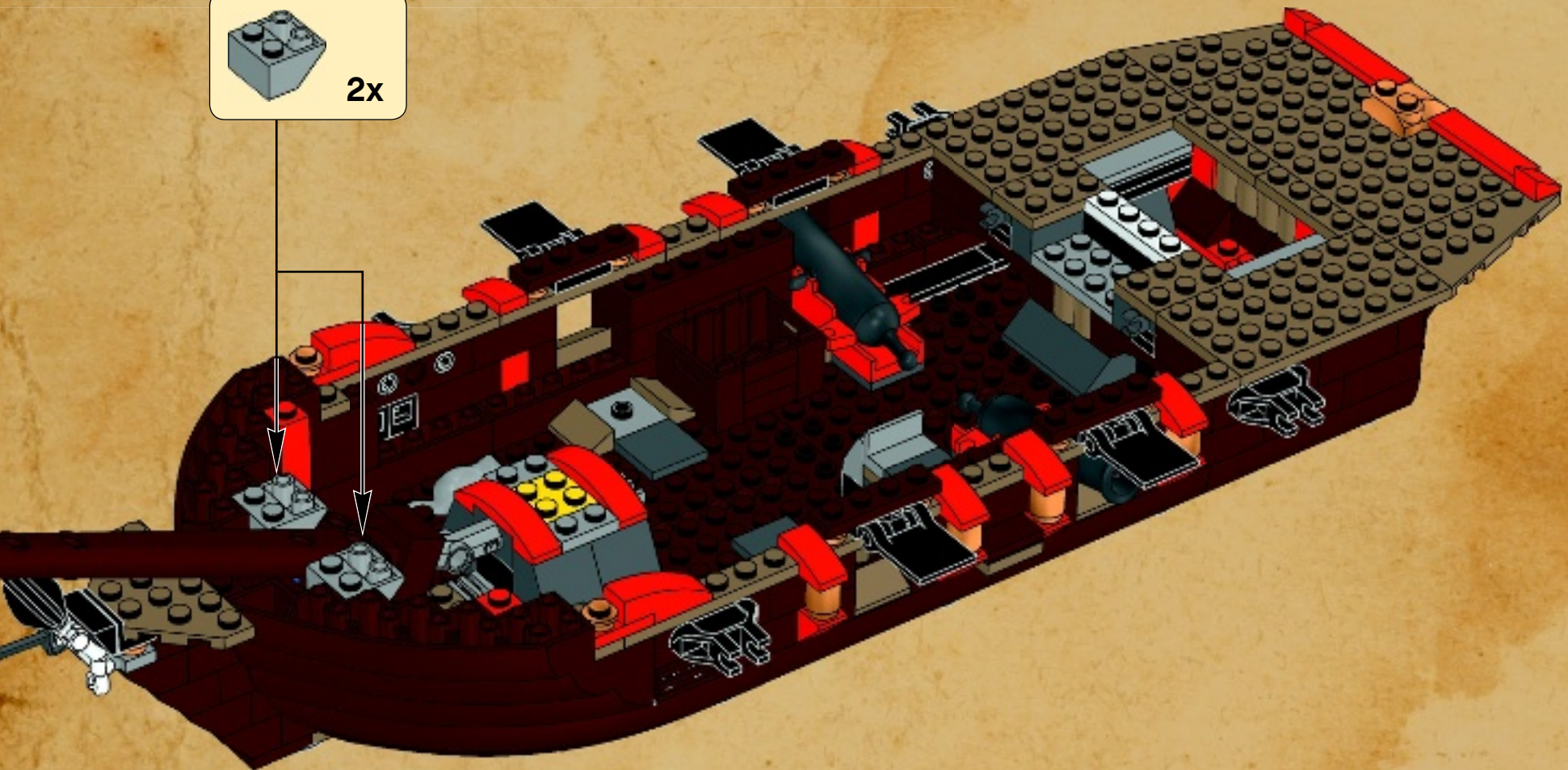
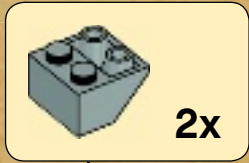

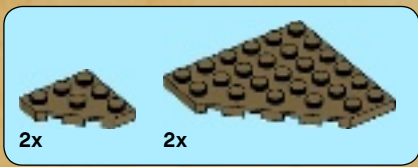

61

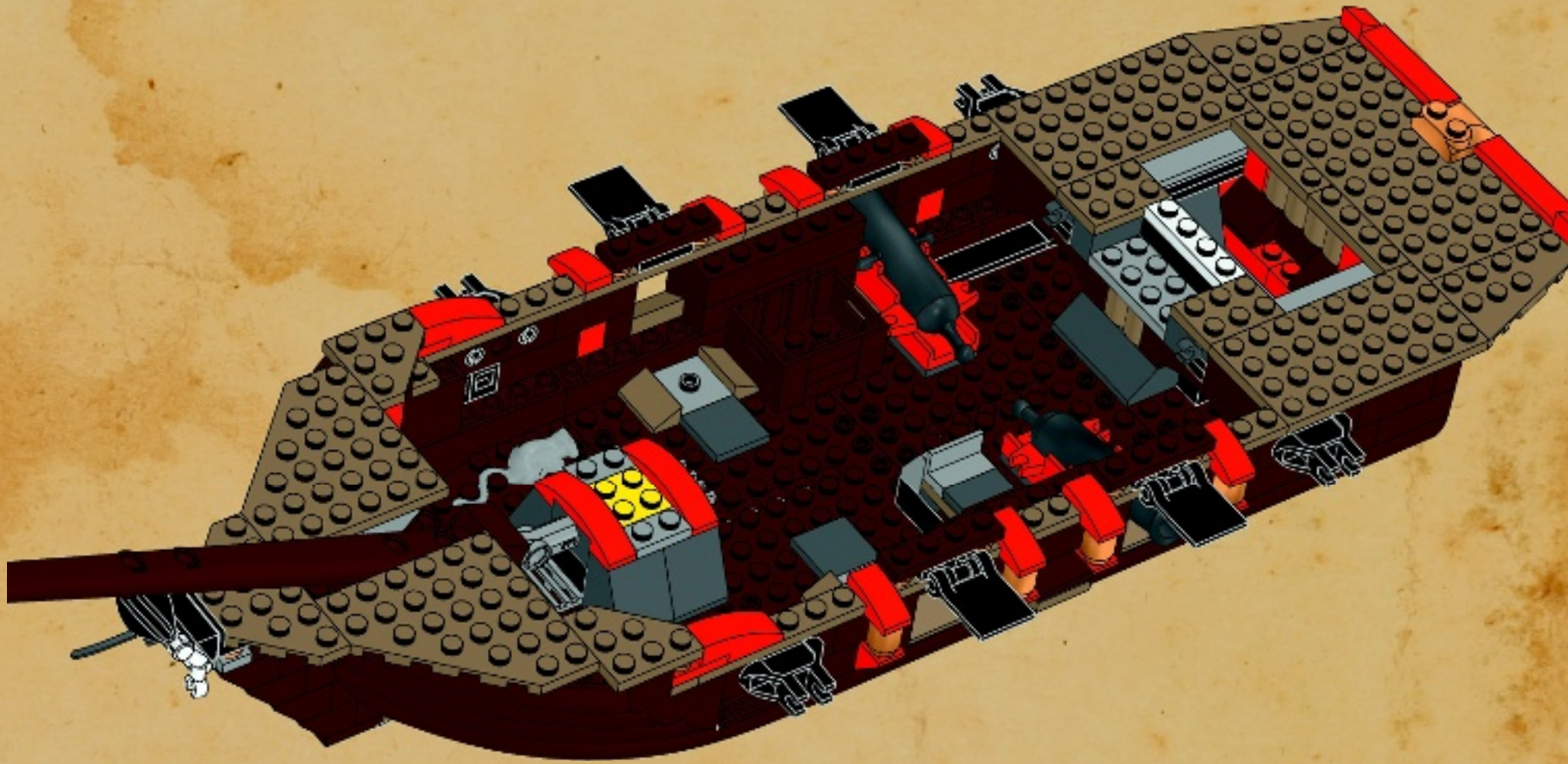



62

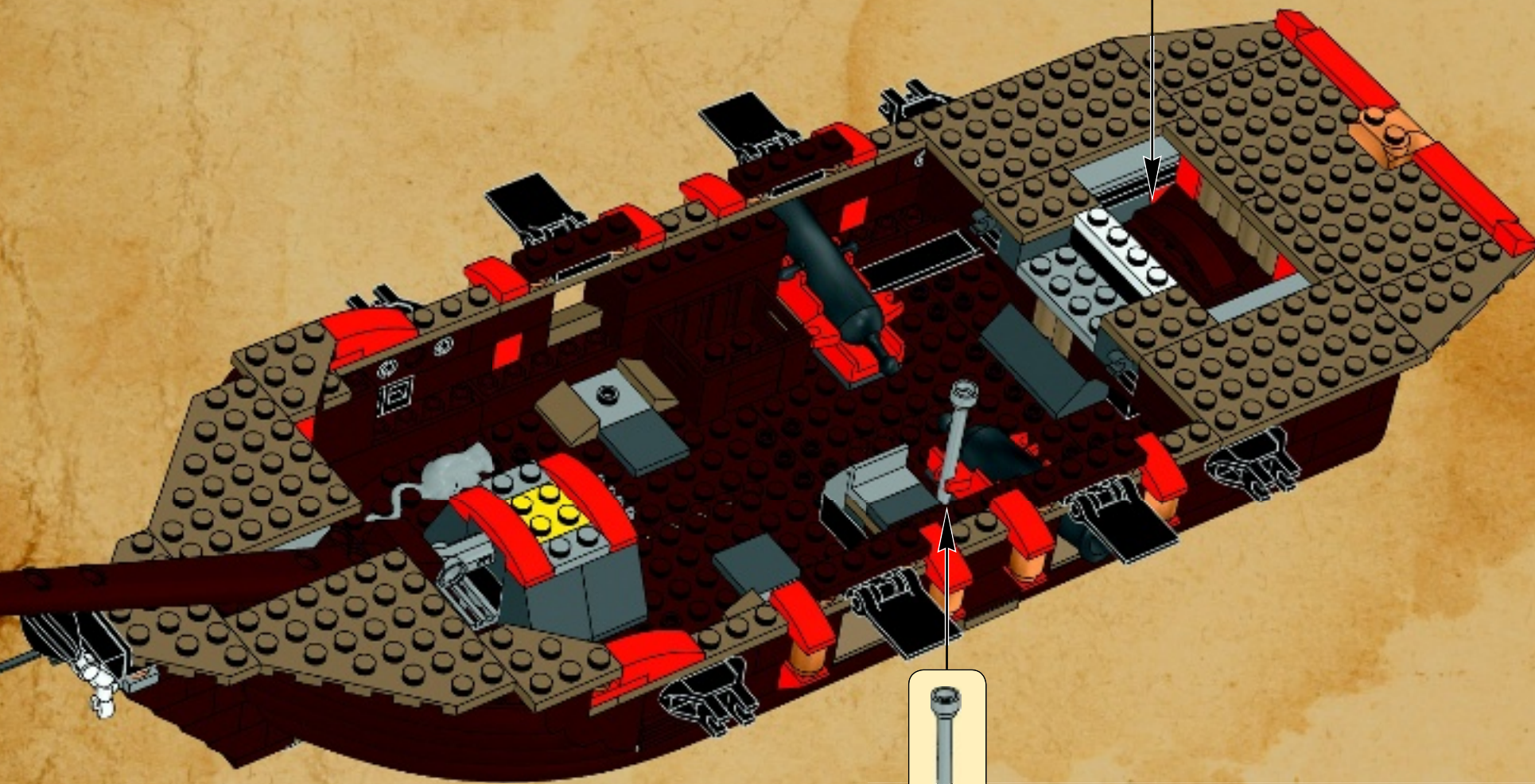

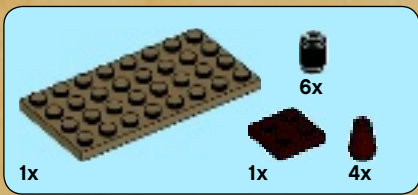

63

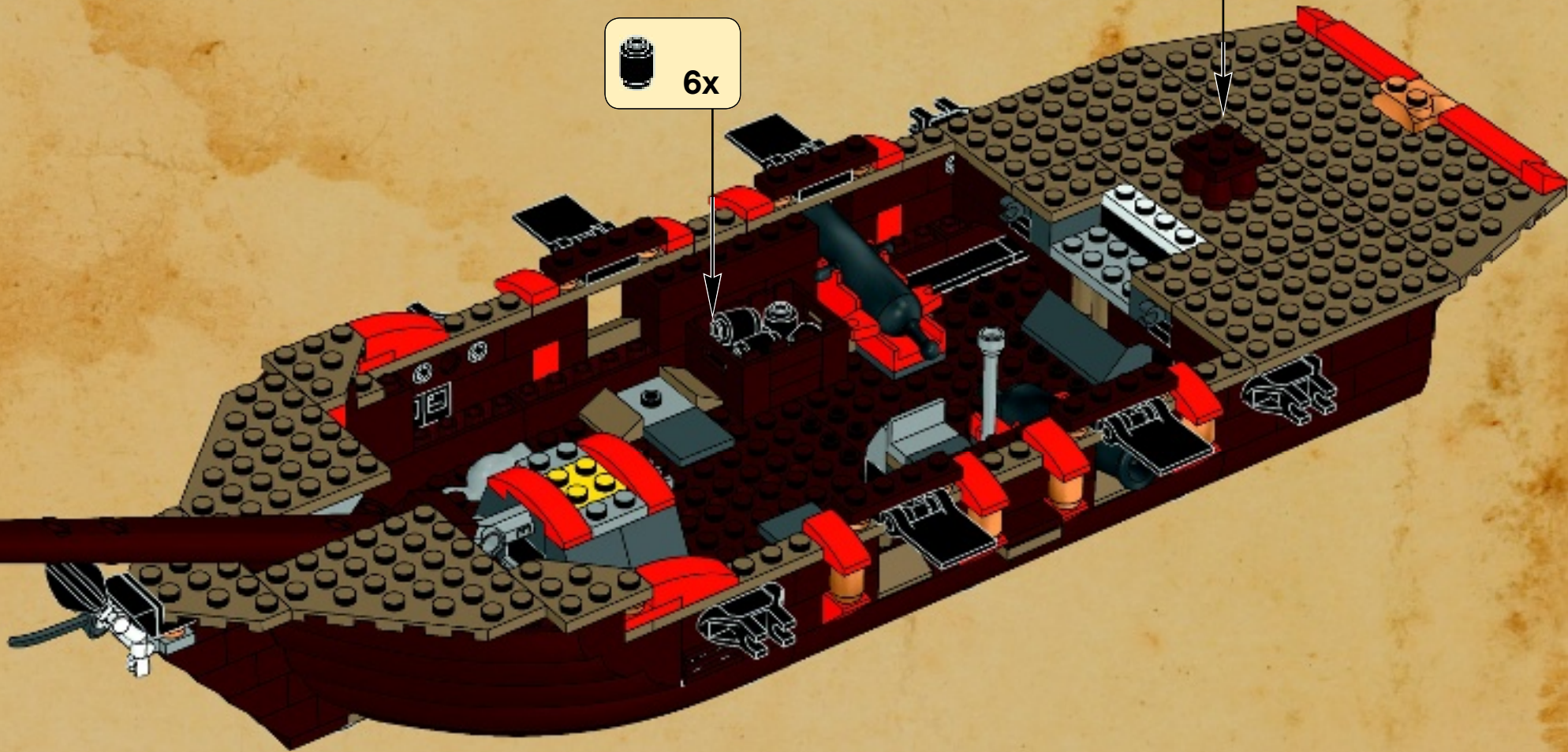
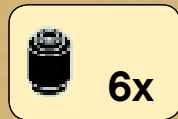
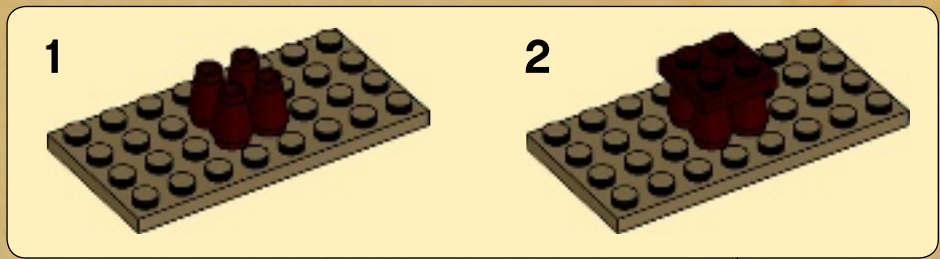

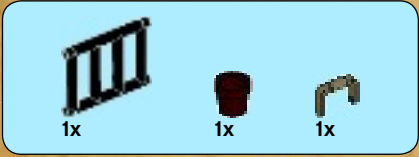
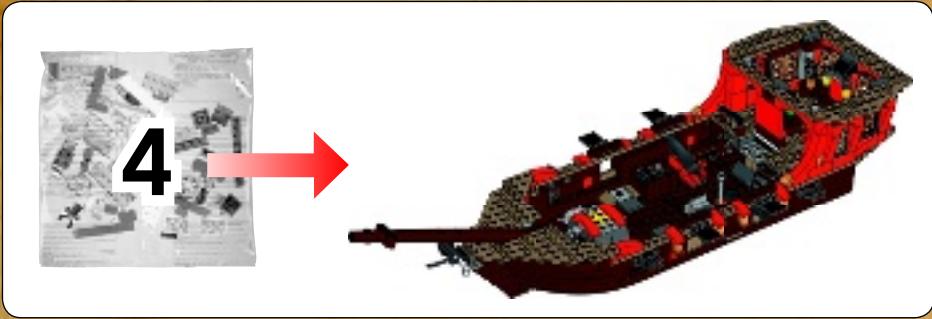

64

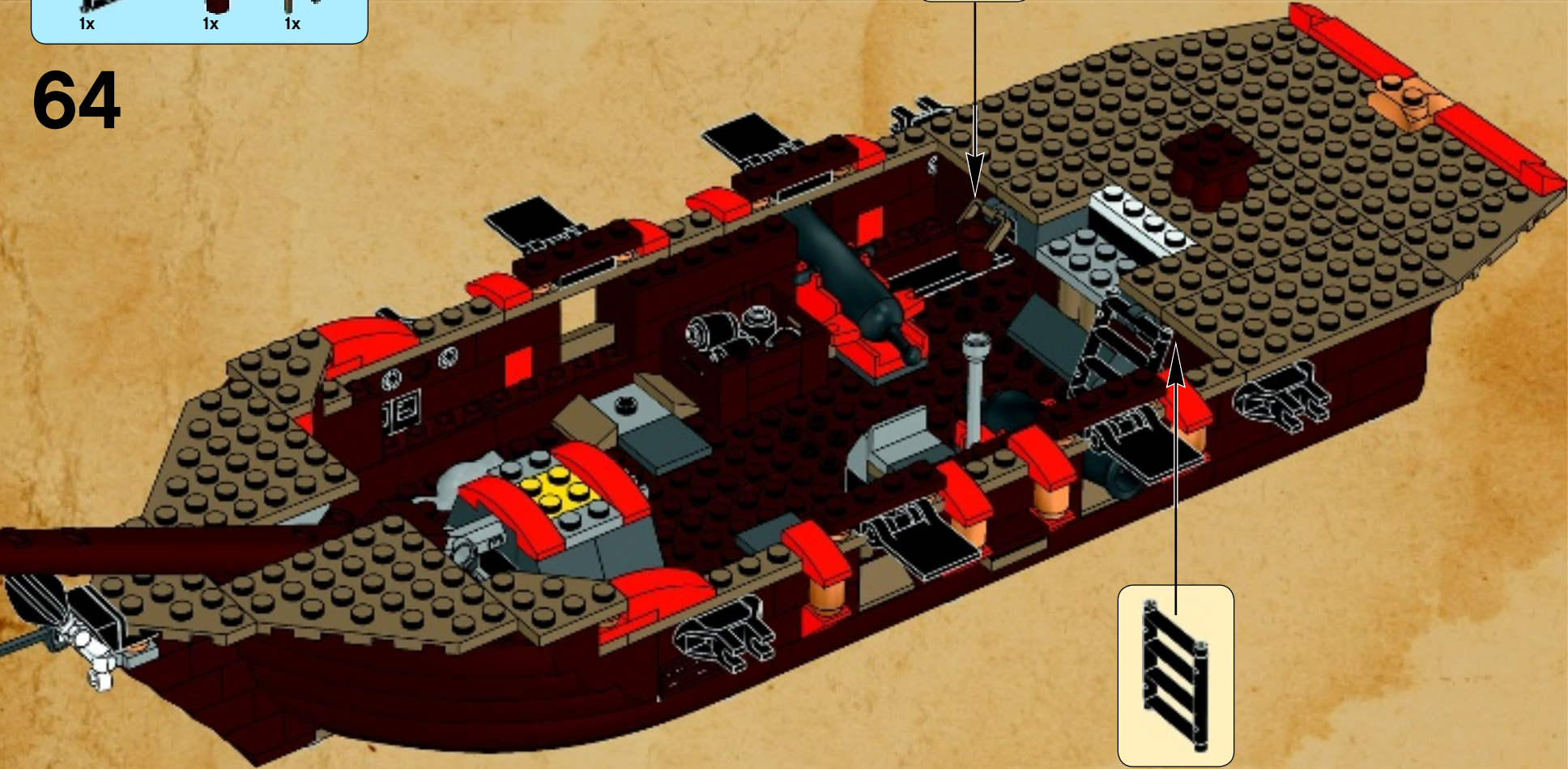





# 65

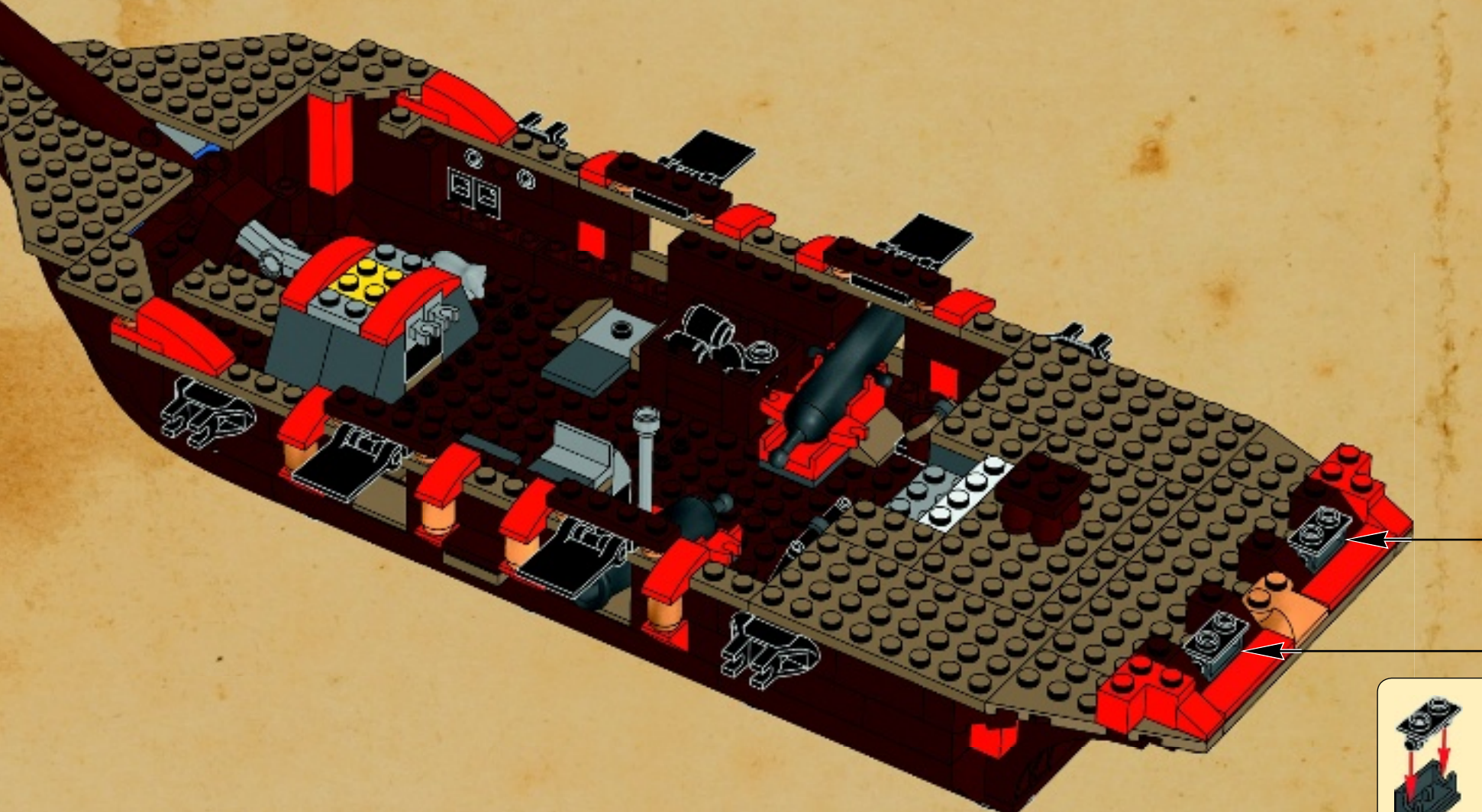



1x



2x

# 66

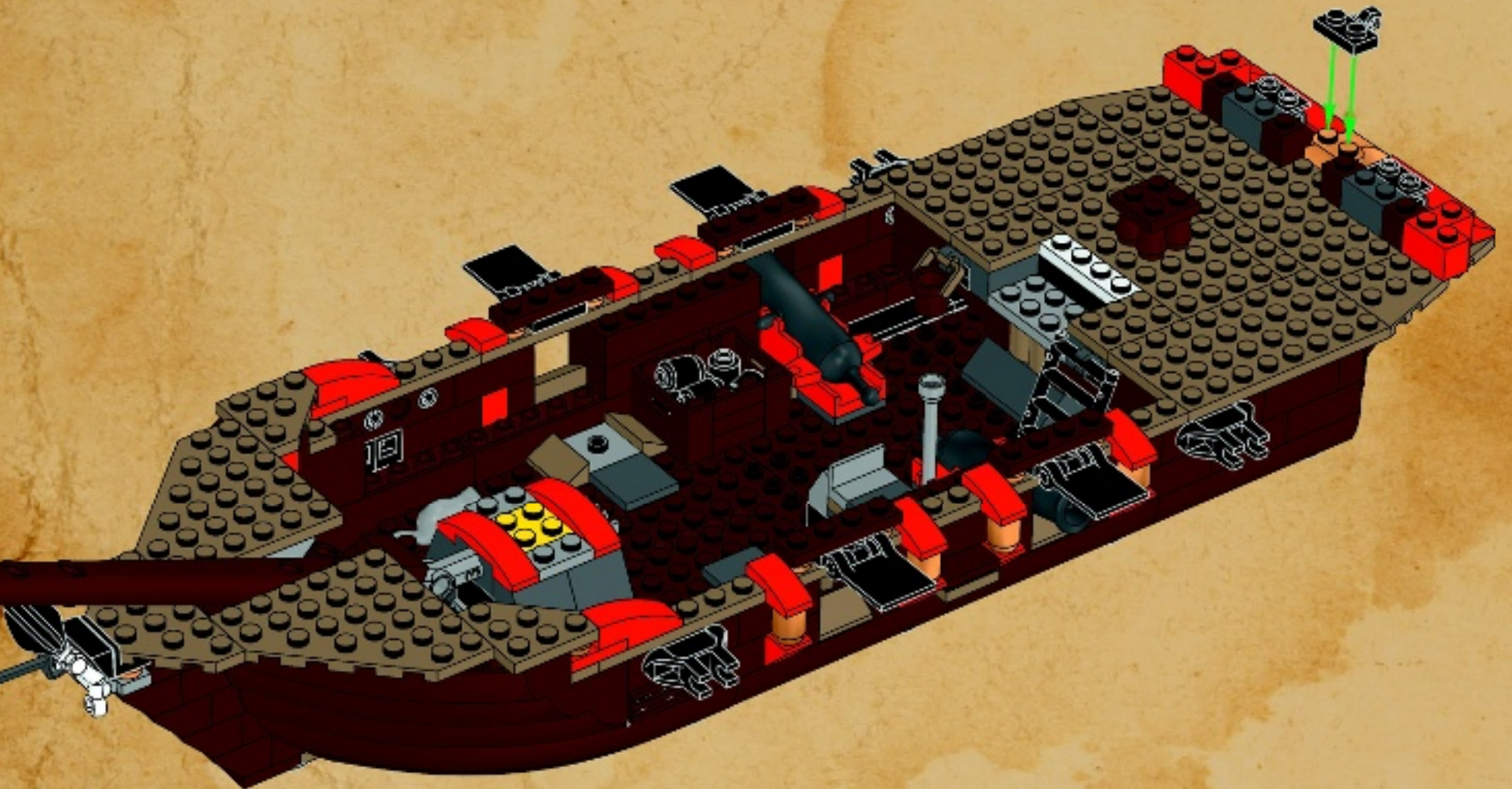



67





2x



2x

# 68

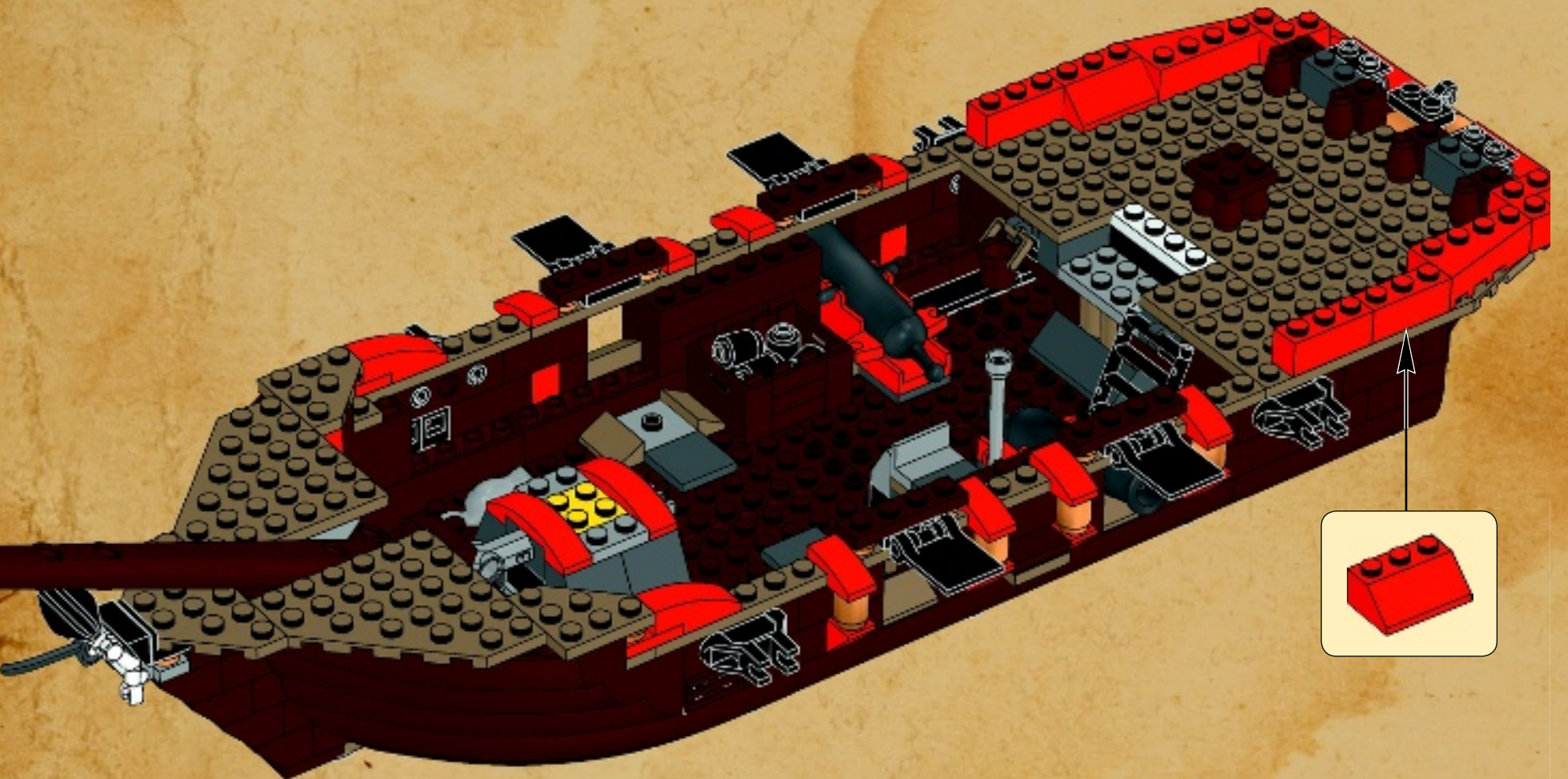



2x

69

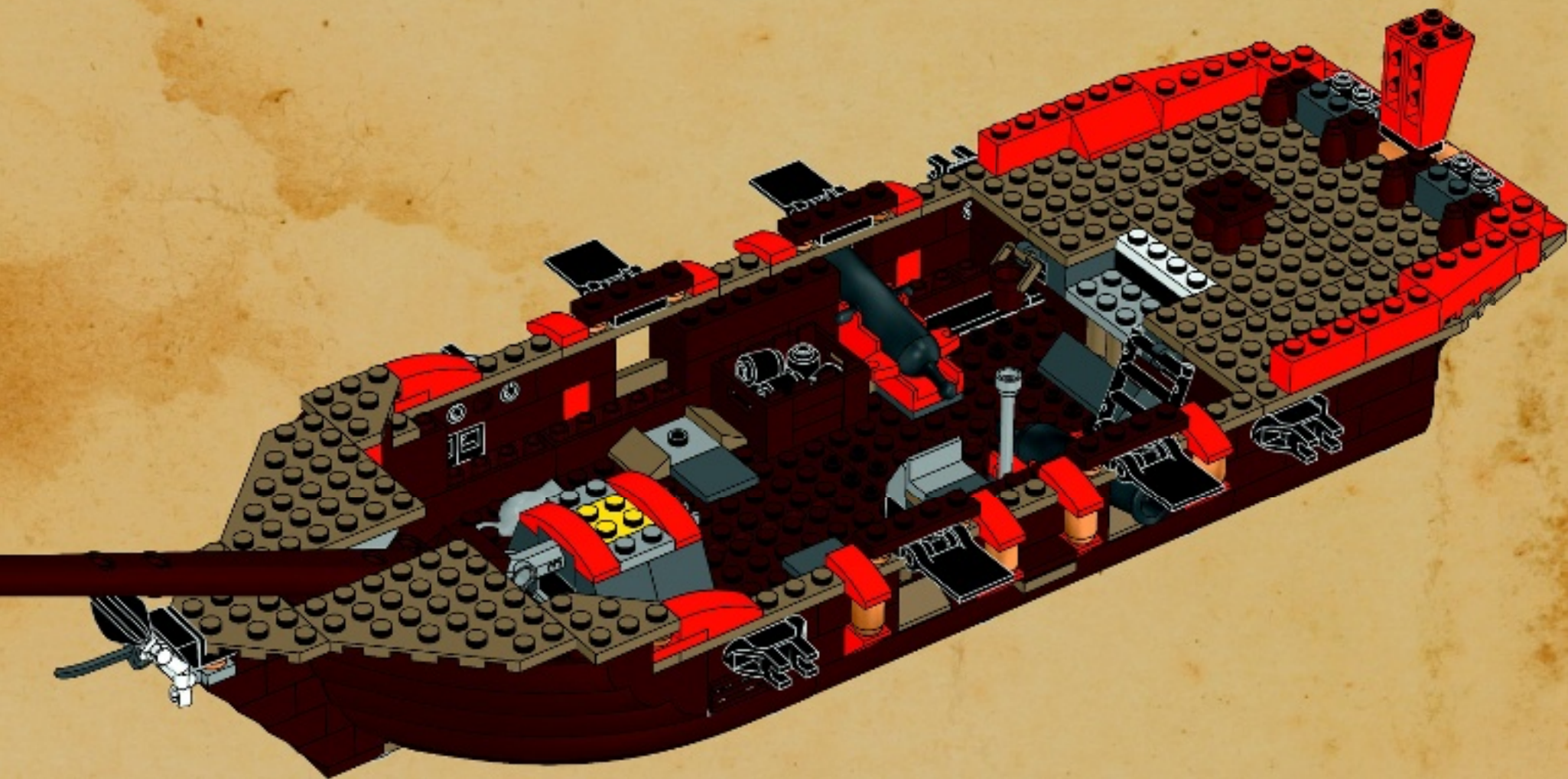



70

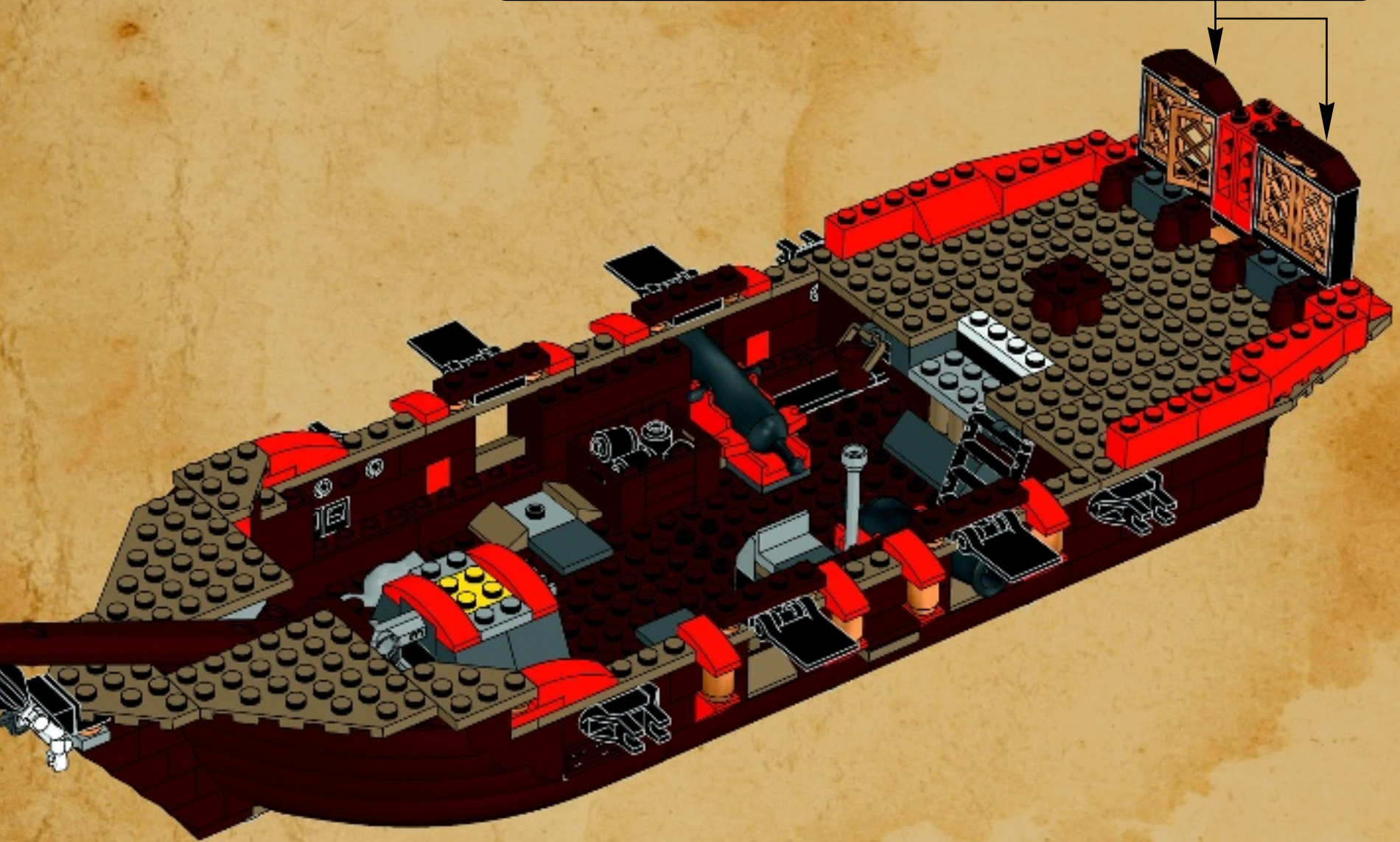
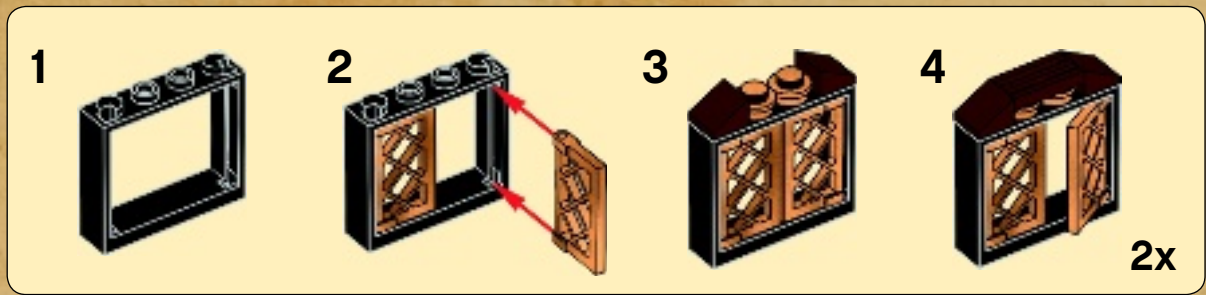

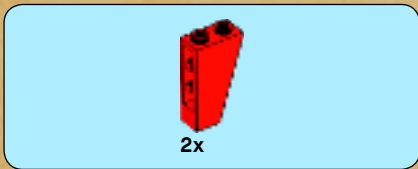

71

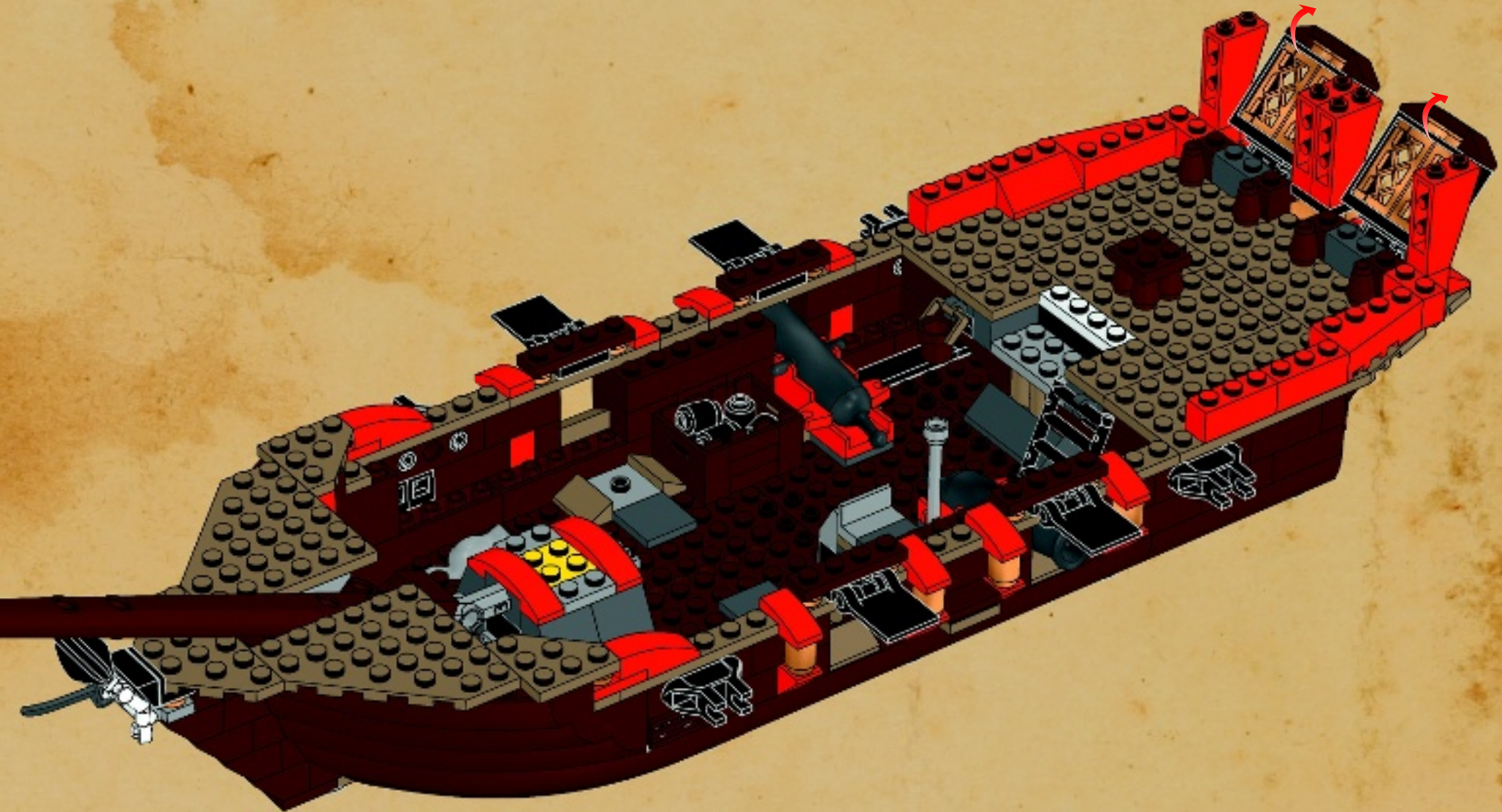



72

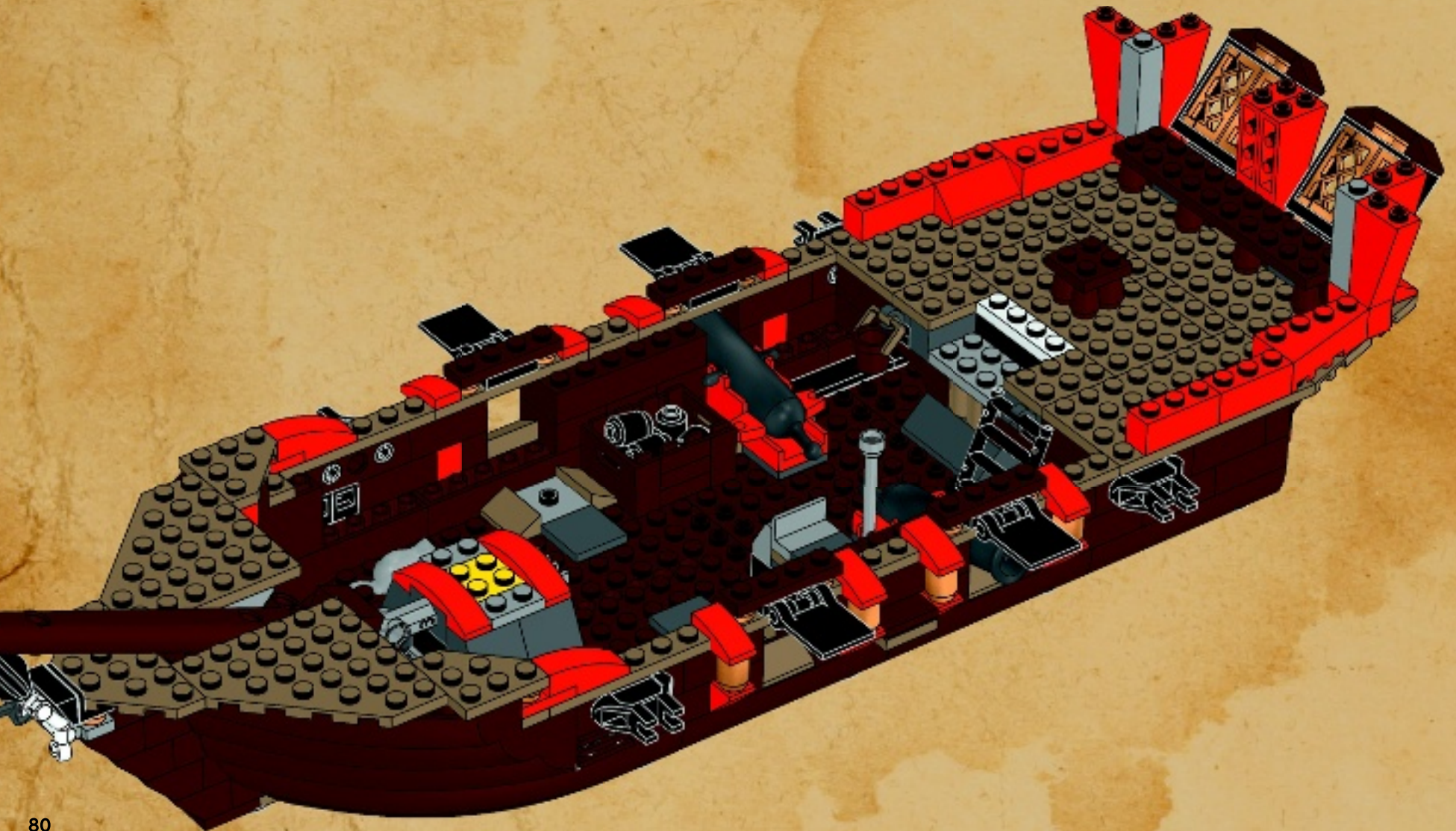





73

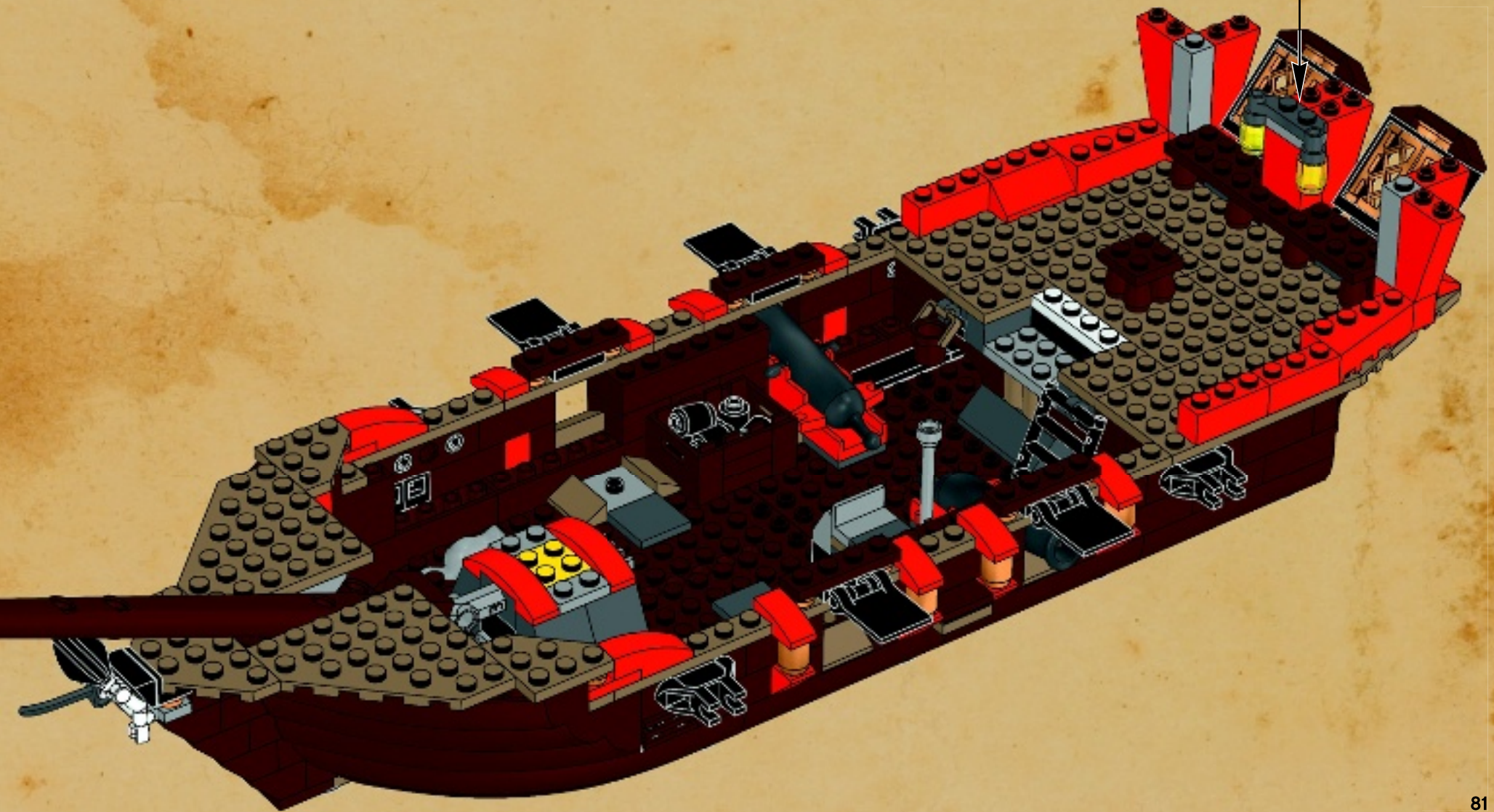

1x  2x 

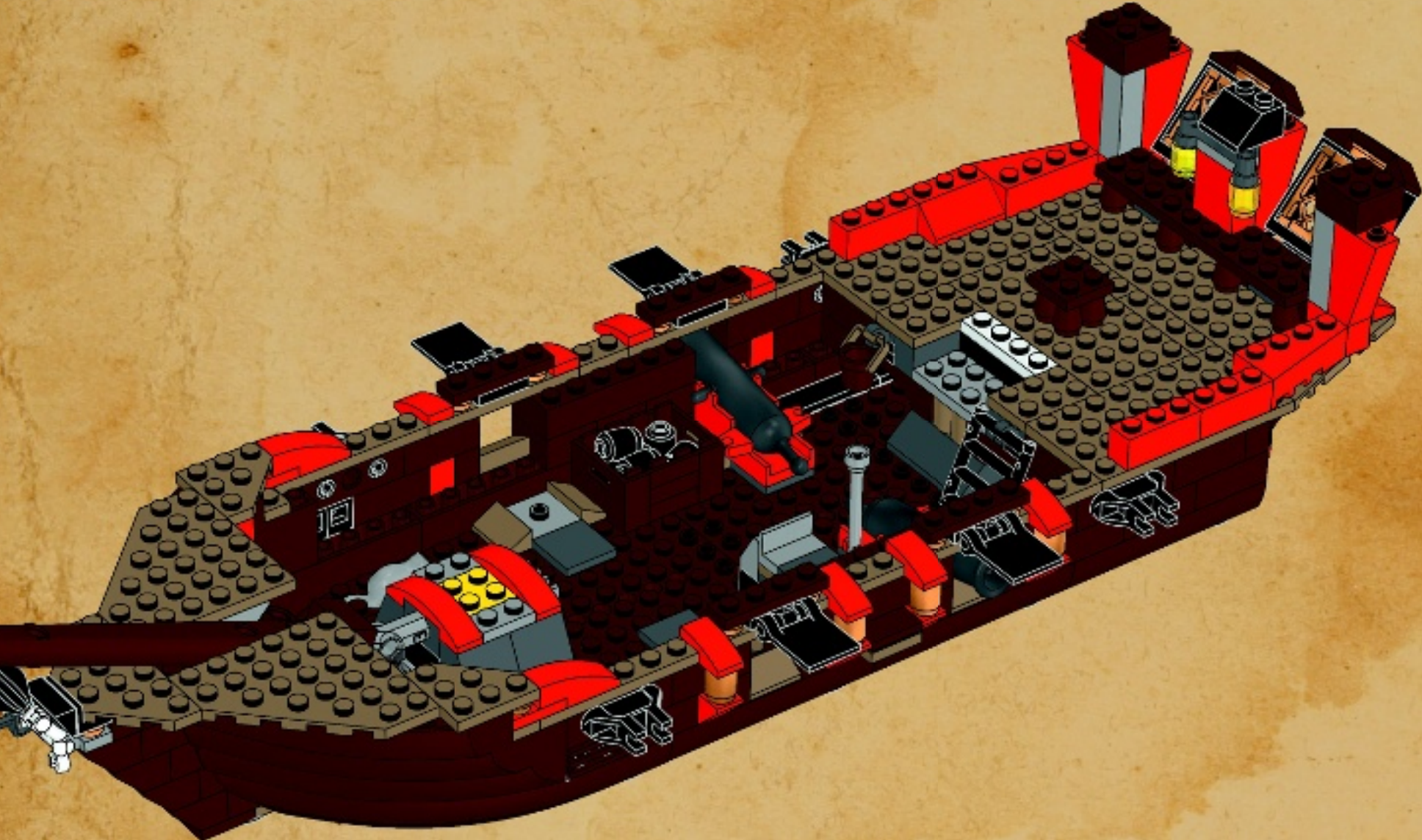

74

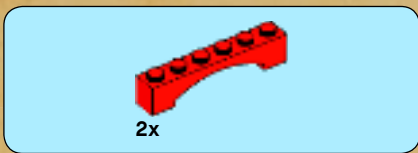

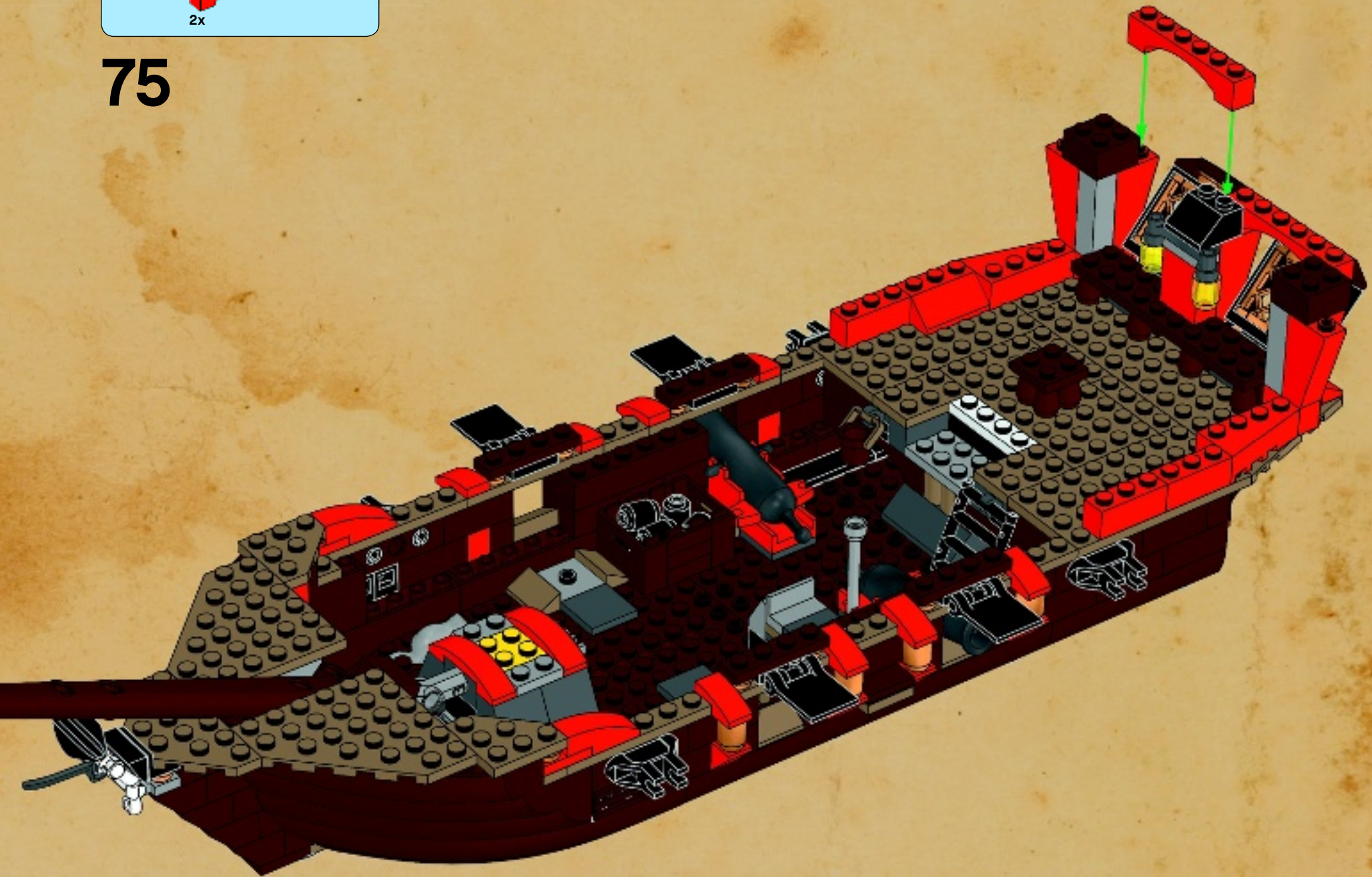

75



- 1x 
- 1x 
- 1x 
- 1x 

# 76

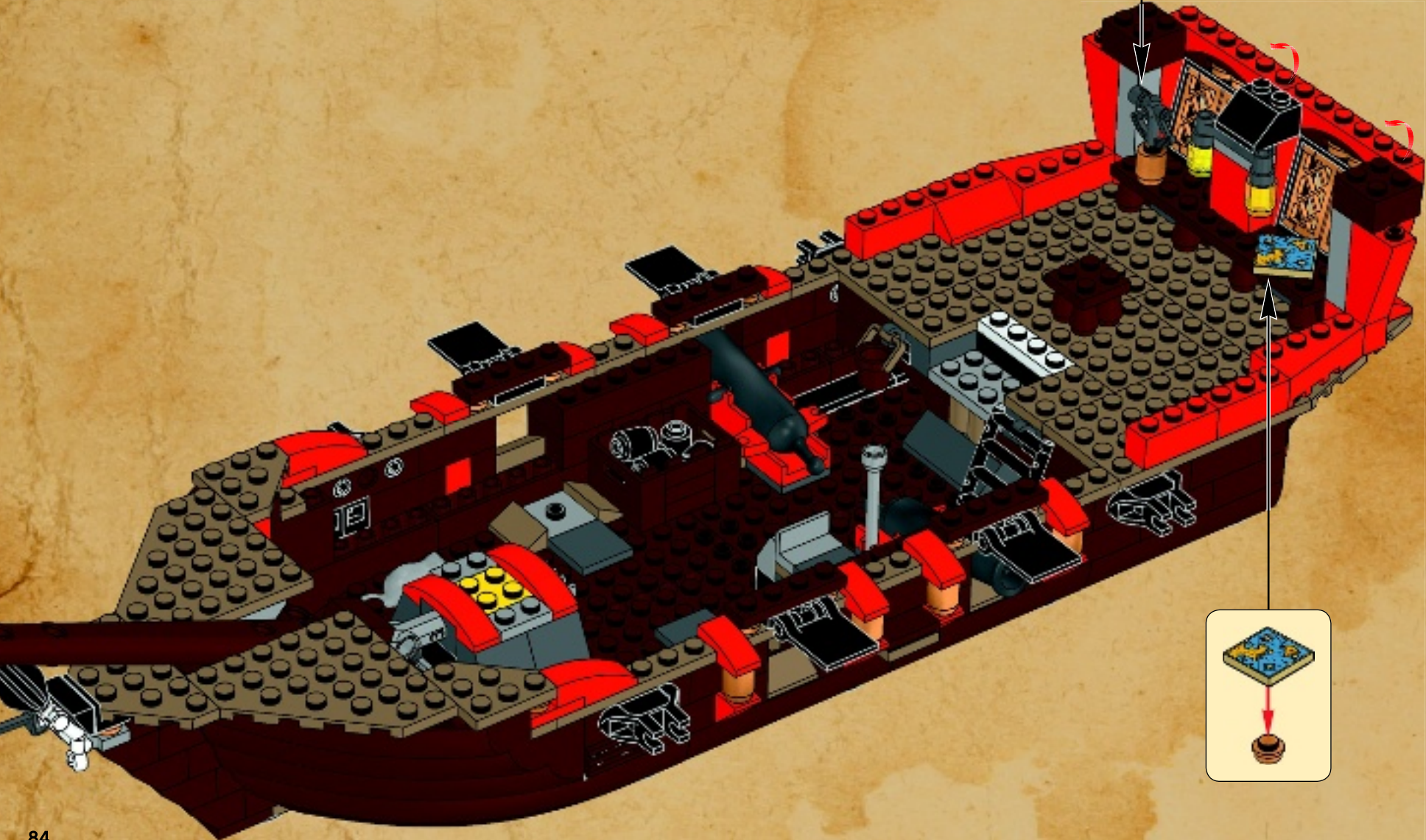

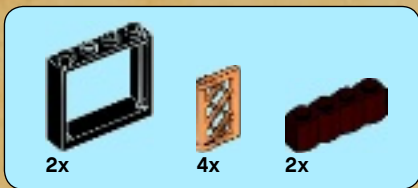

77

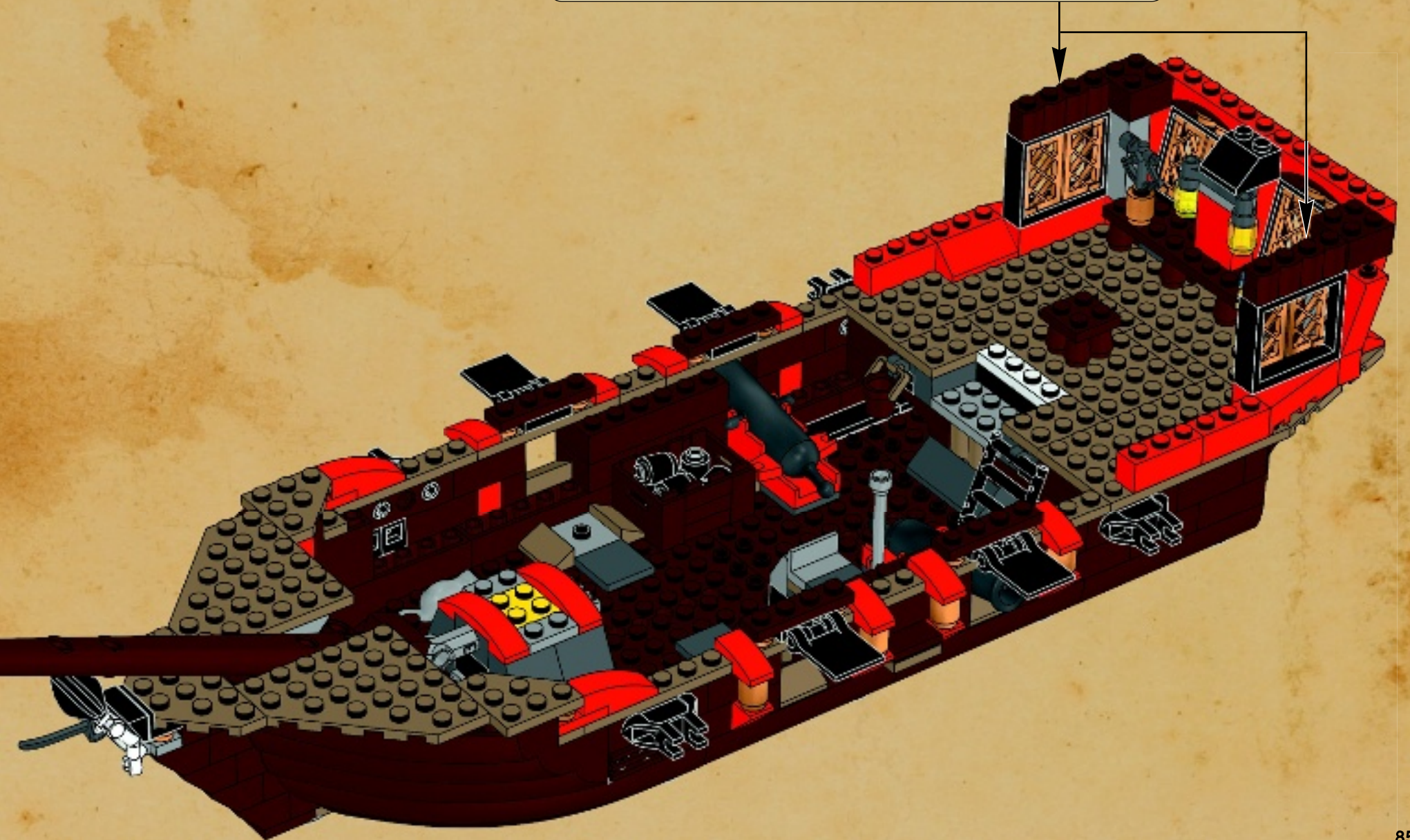
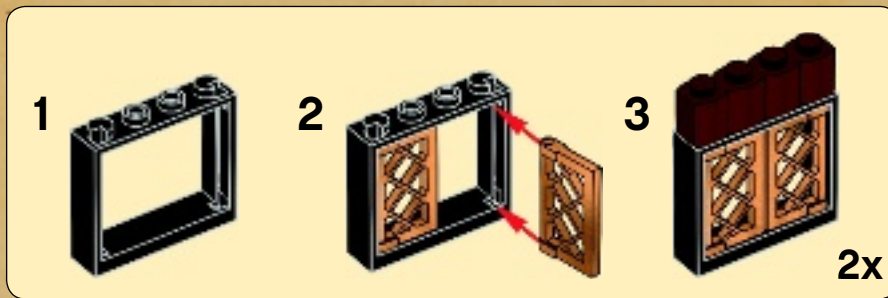



78

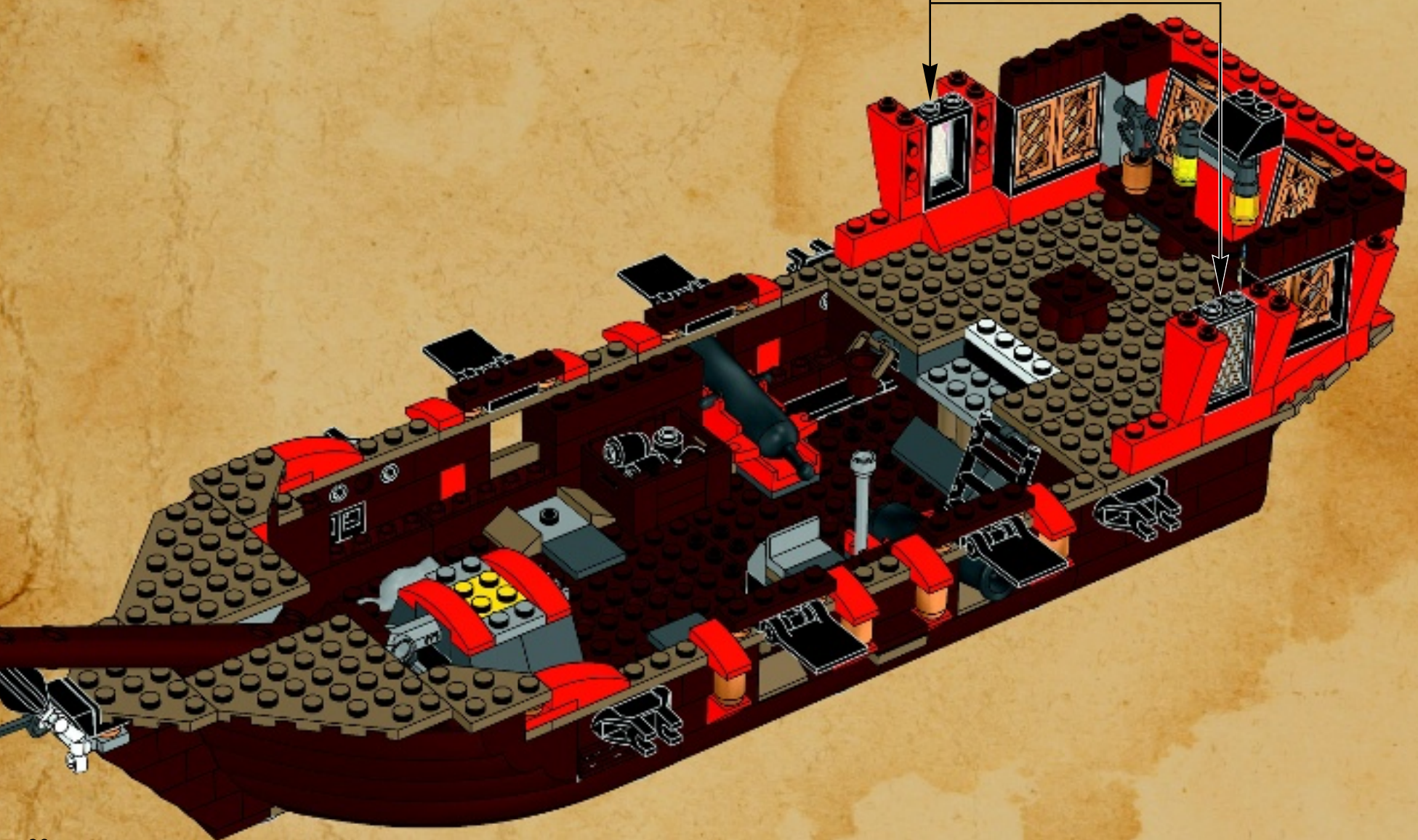
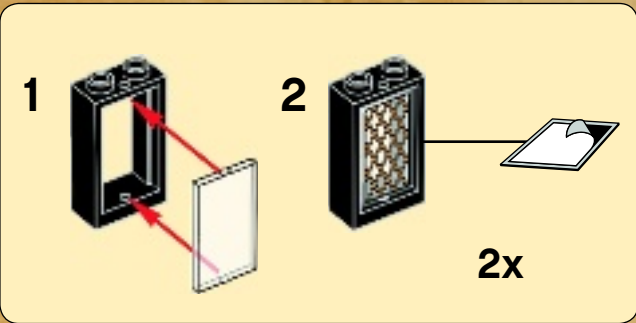

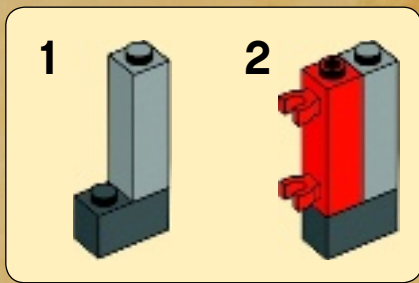
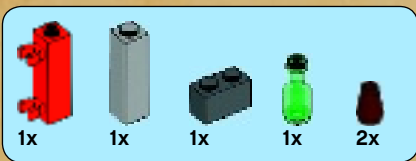

79

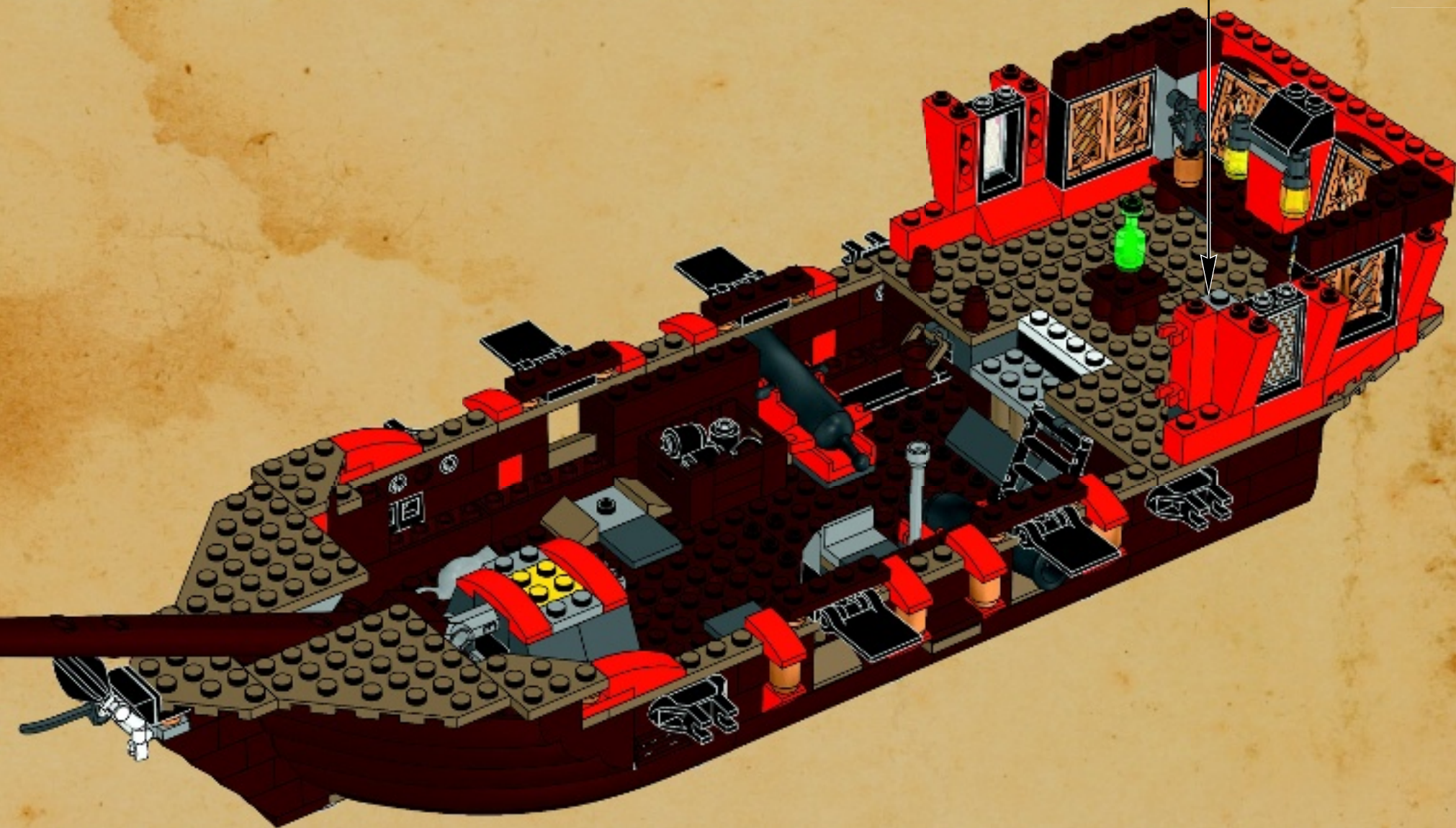



80

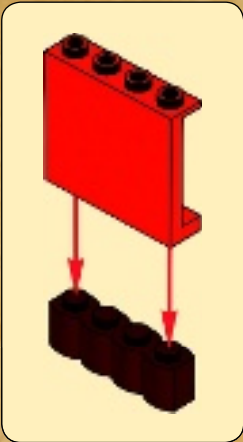



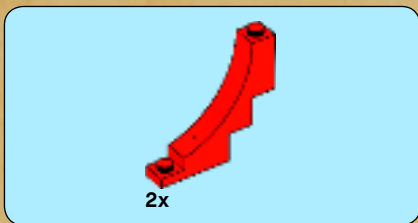



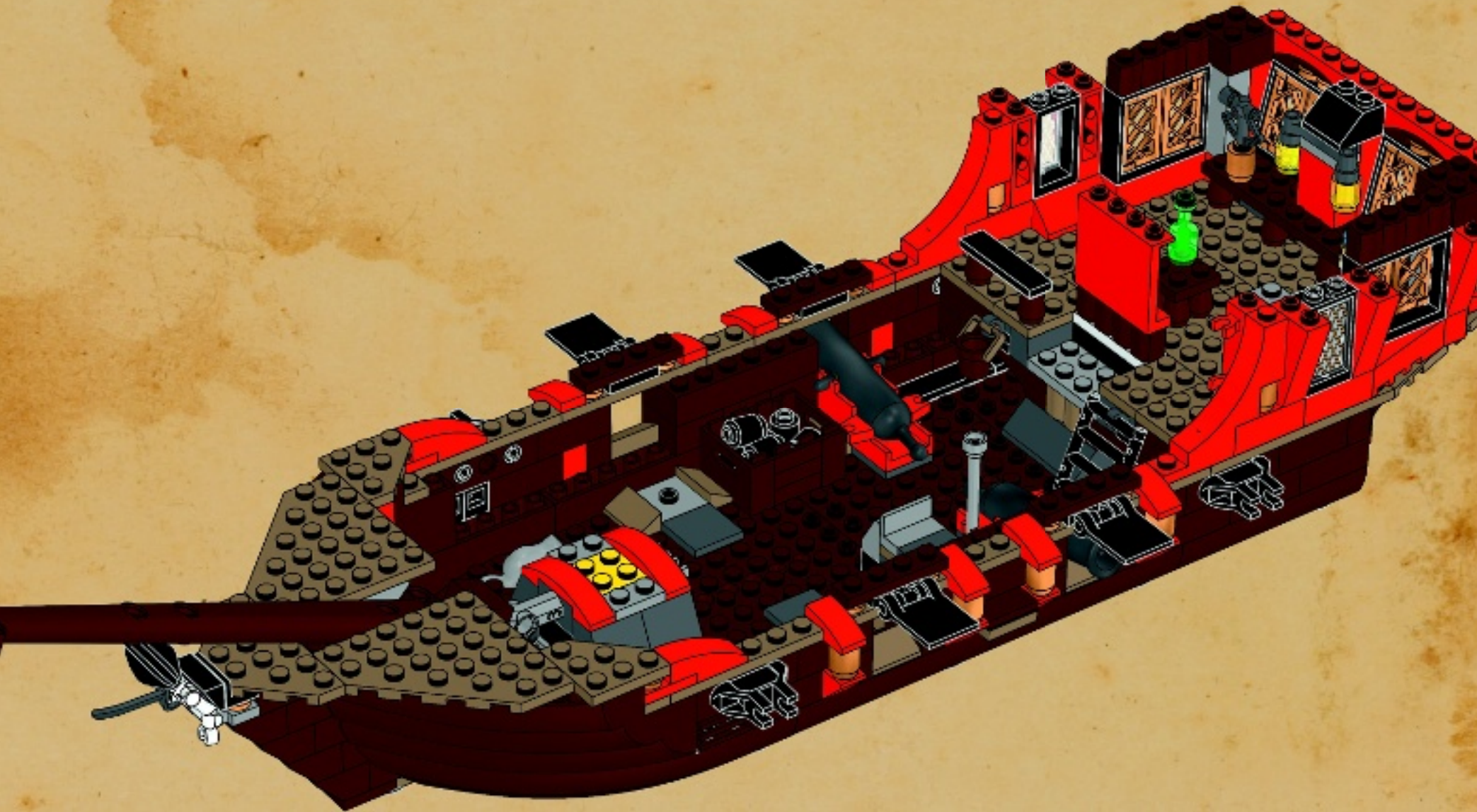

81



2x  2x 

82



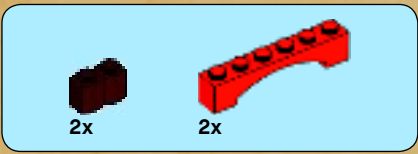

83





2x



2x



2x

# 84



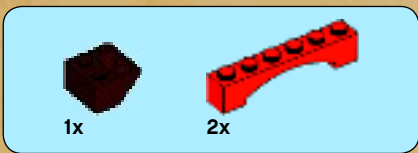

85

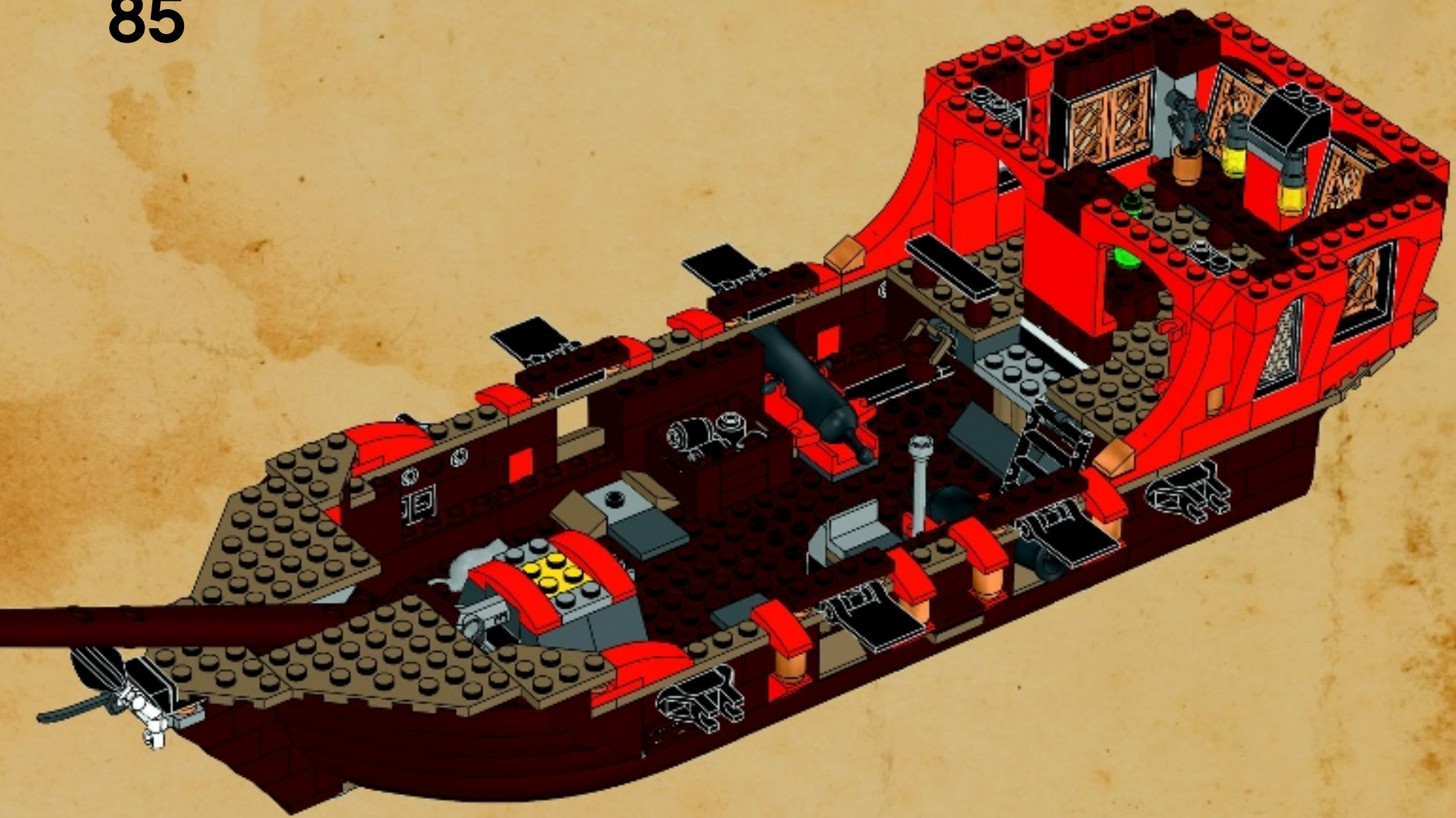



2x



2x

# 86

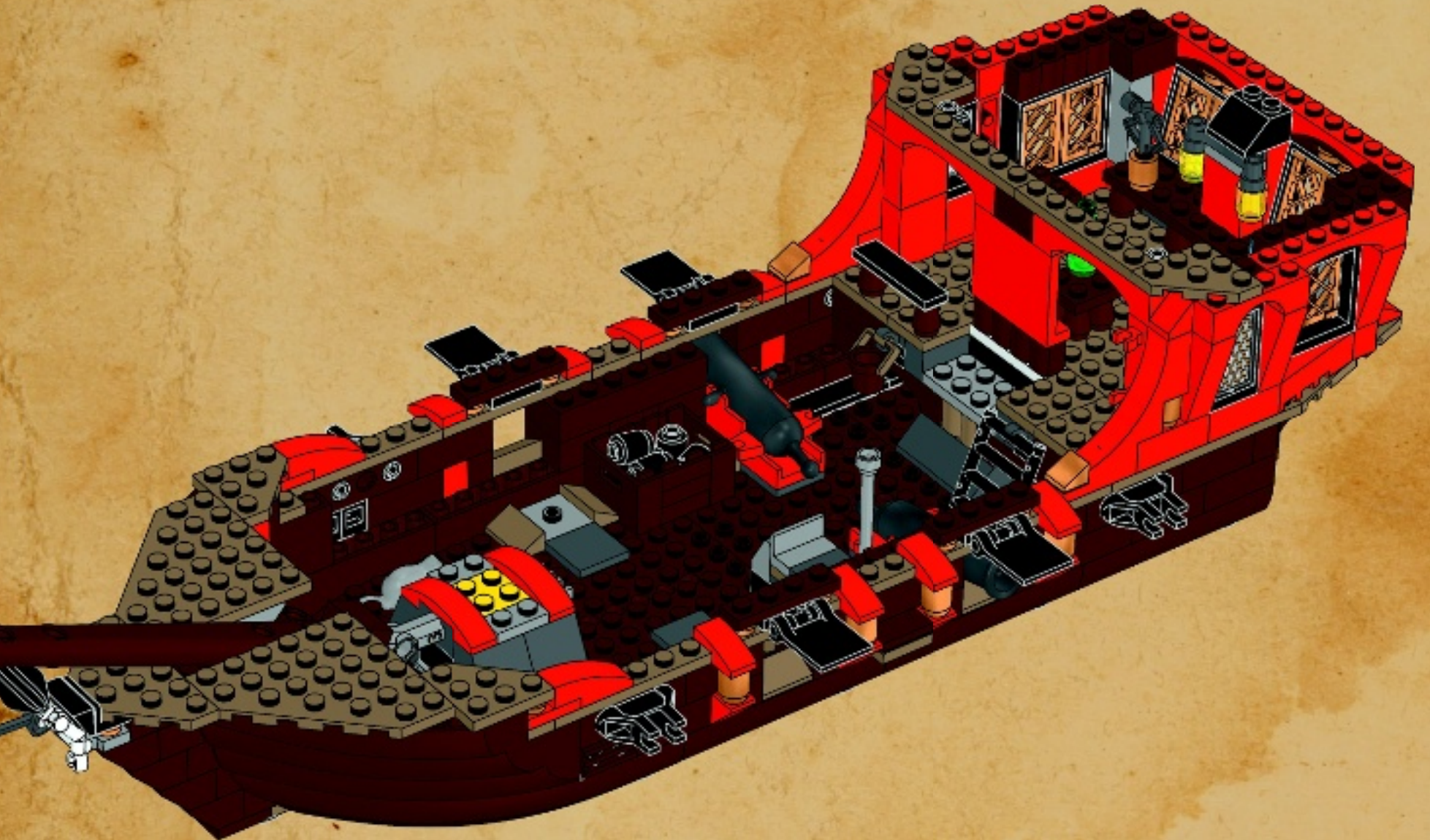

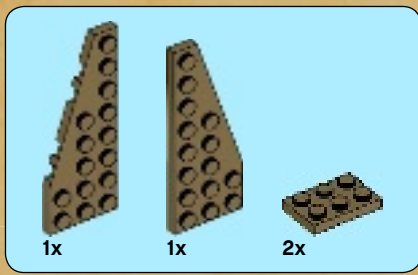

87

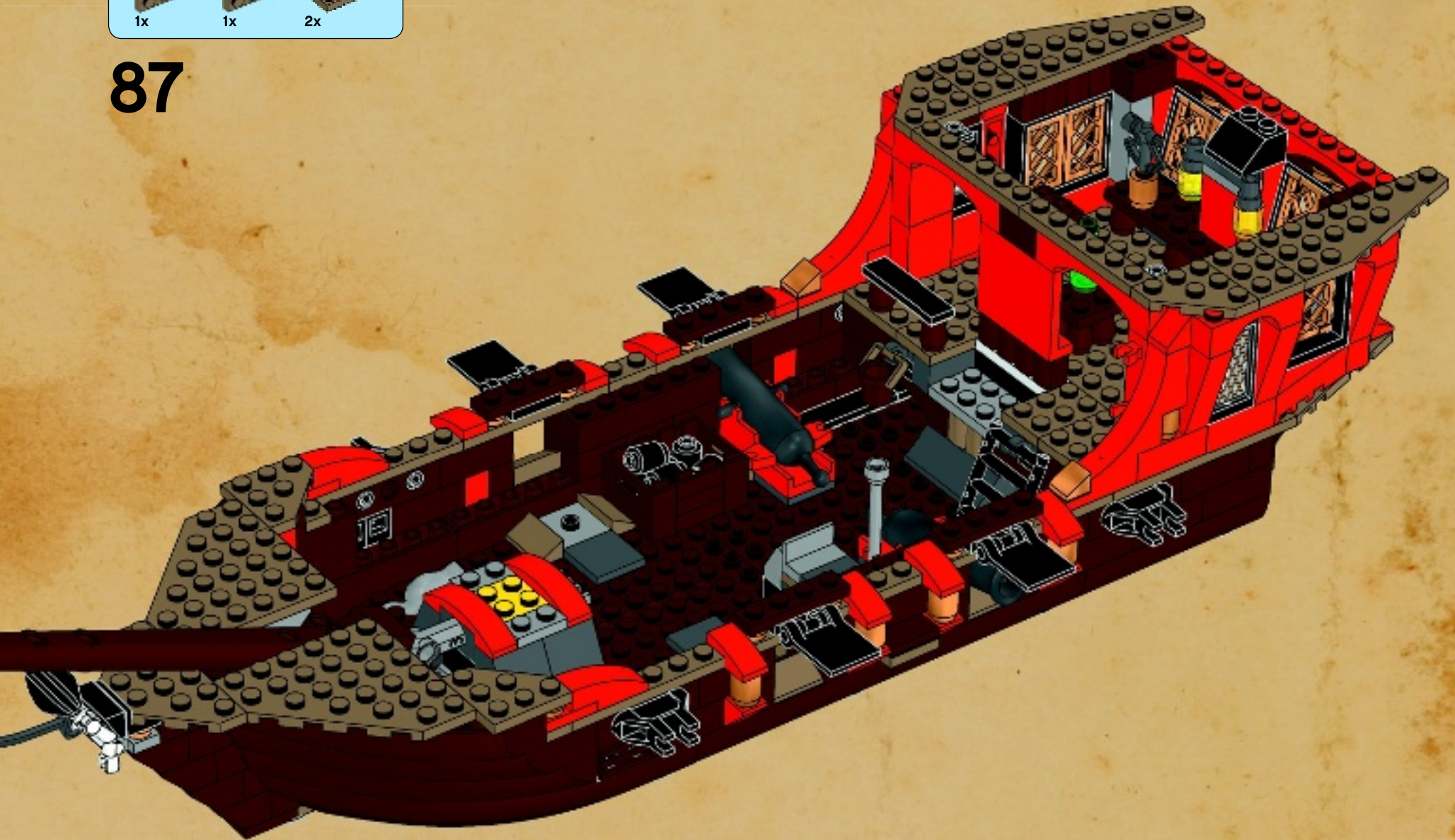



2x

88

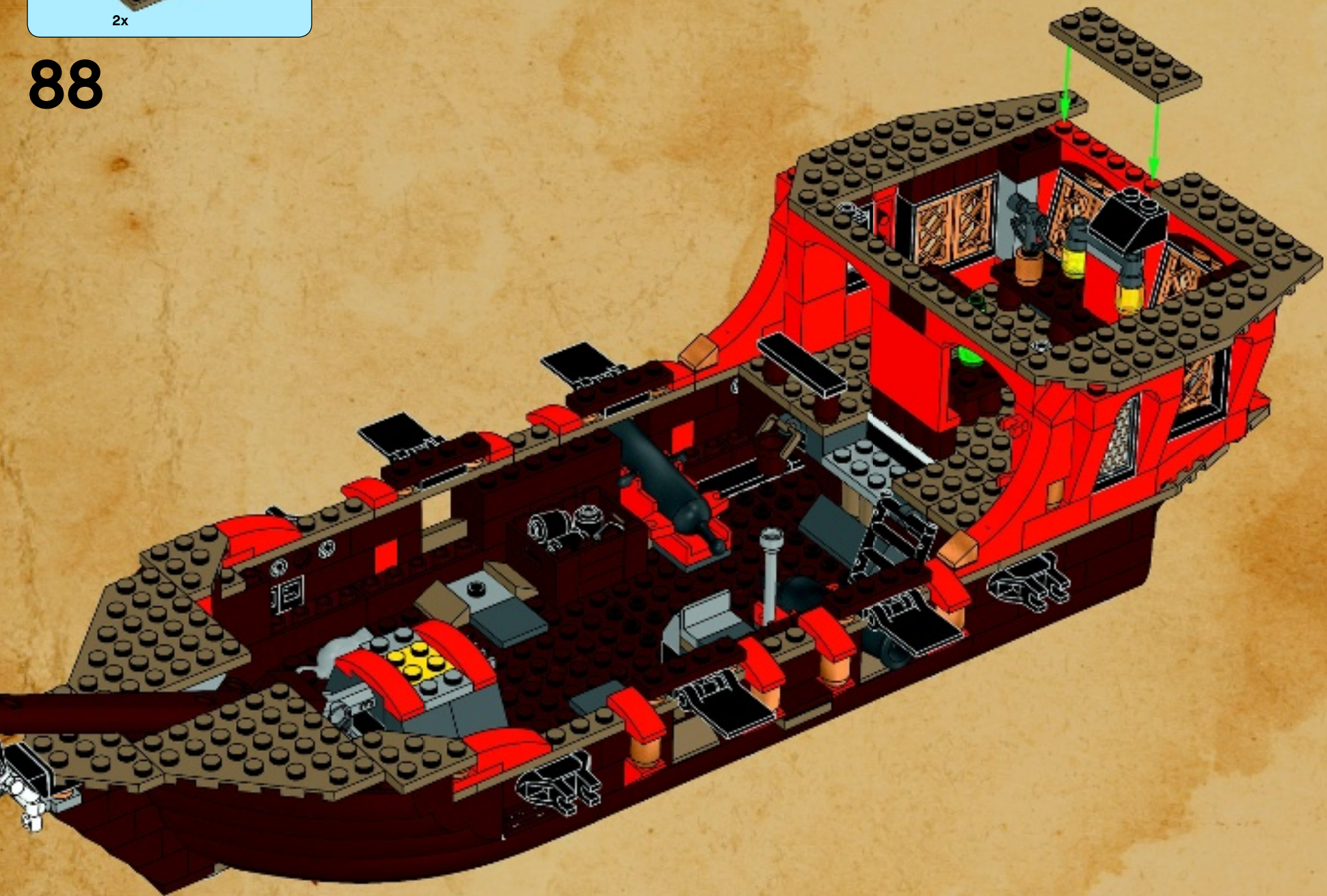





4x



2x

# 89

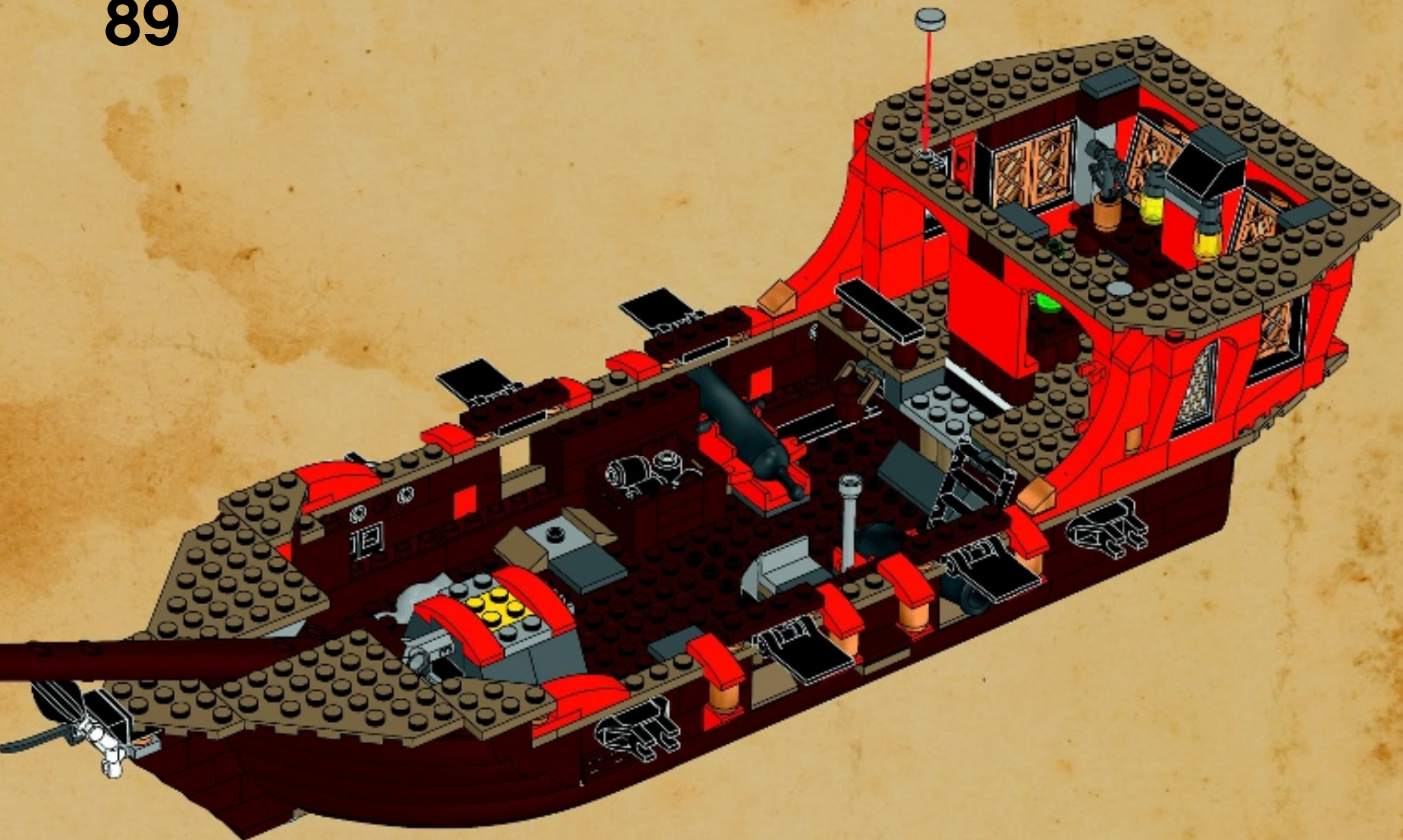

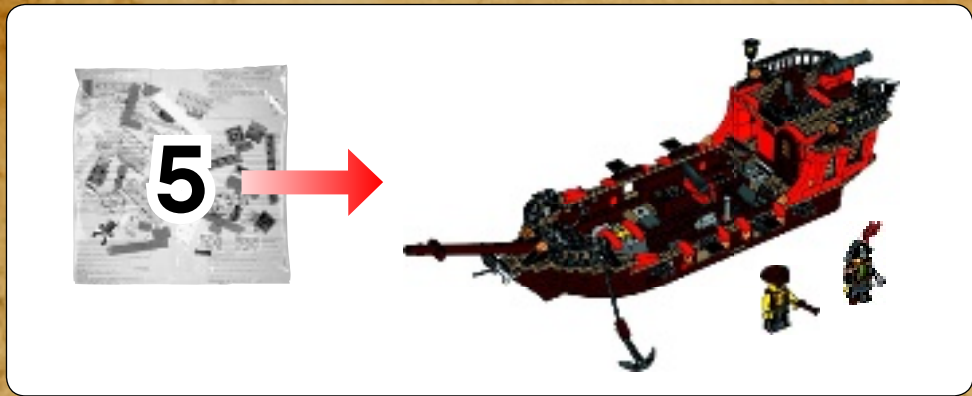



2x



1x

90

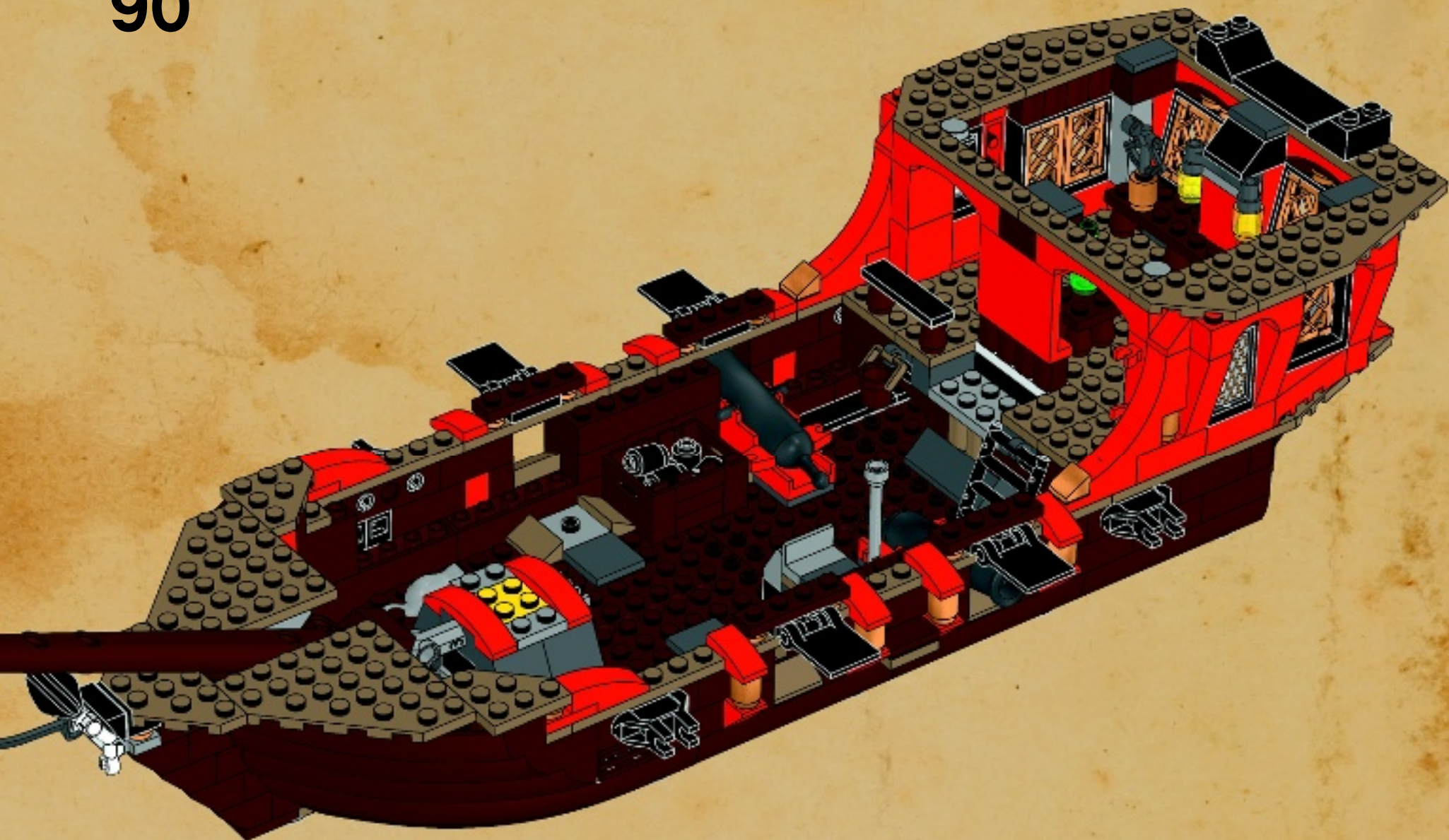



2x



2x

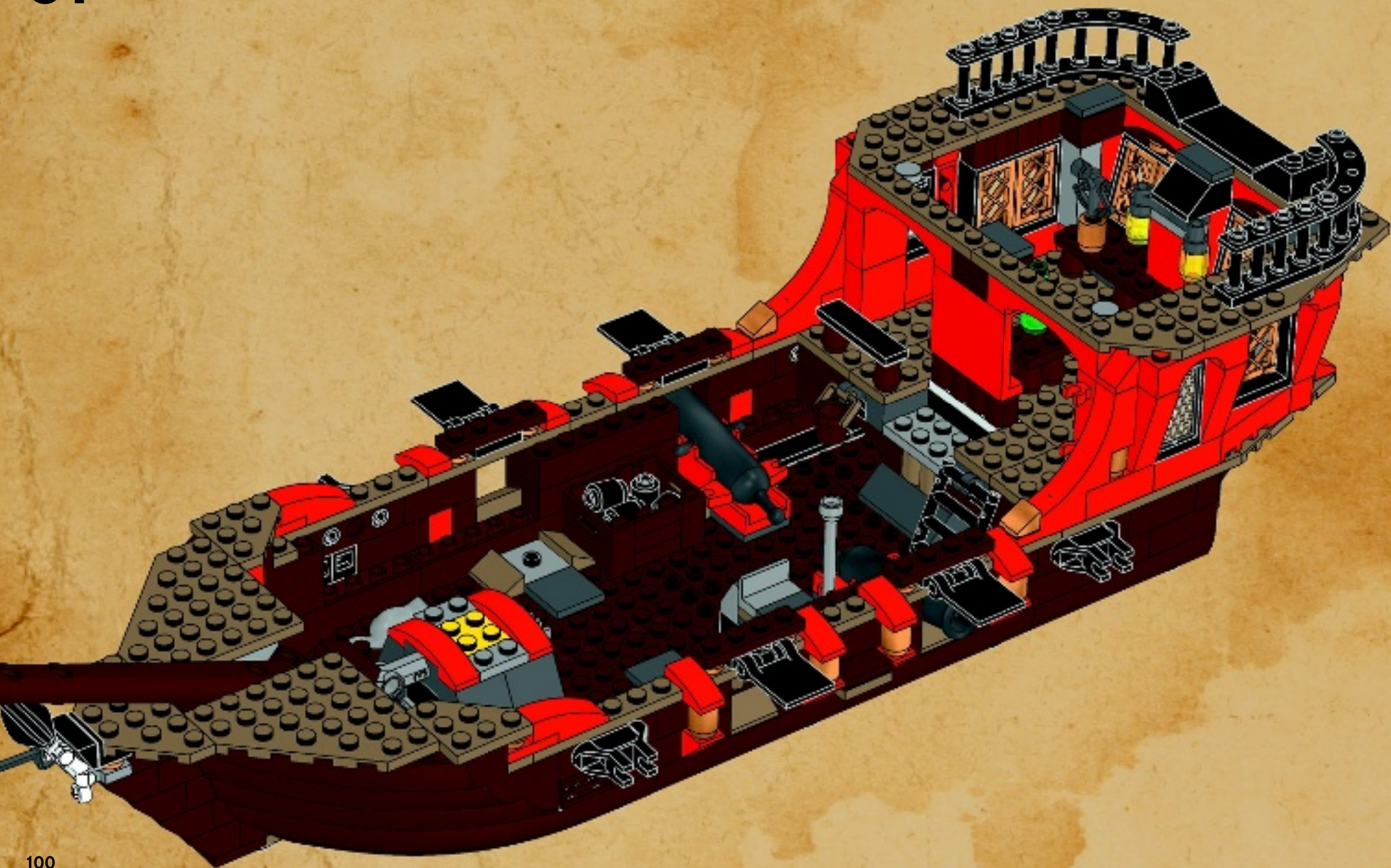

# 91





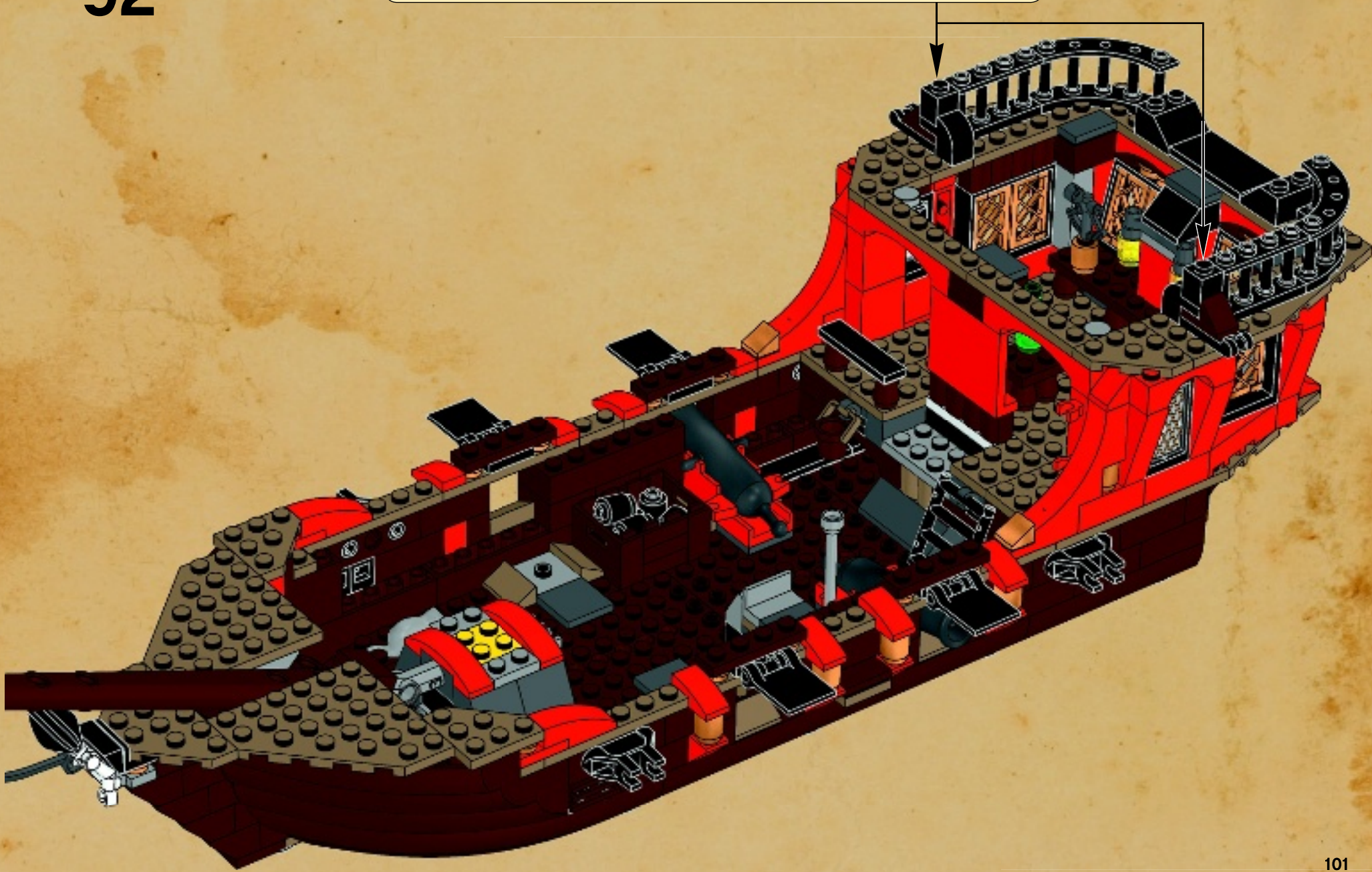

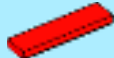
92



2x  2x  4x 

93

   2x

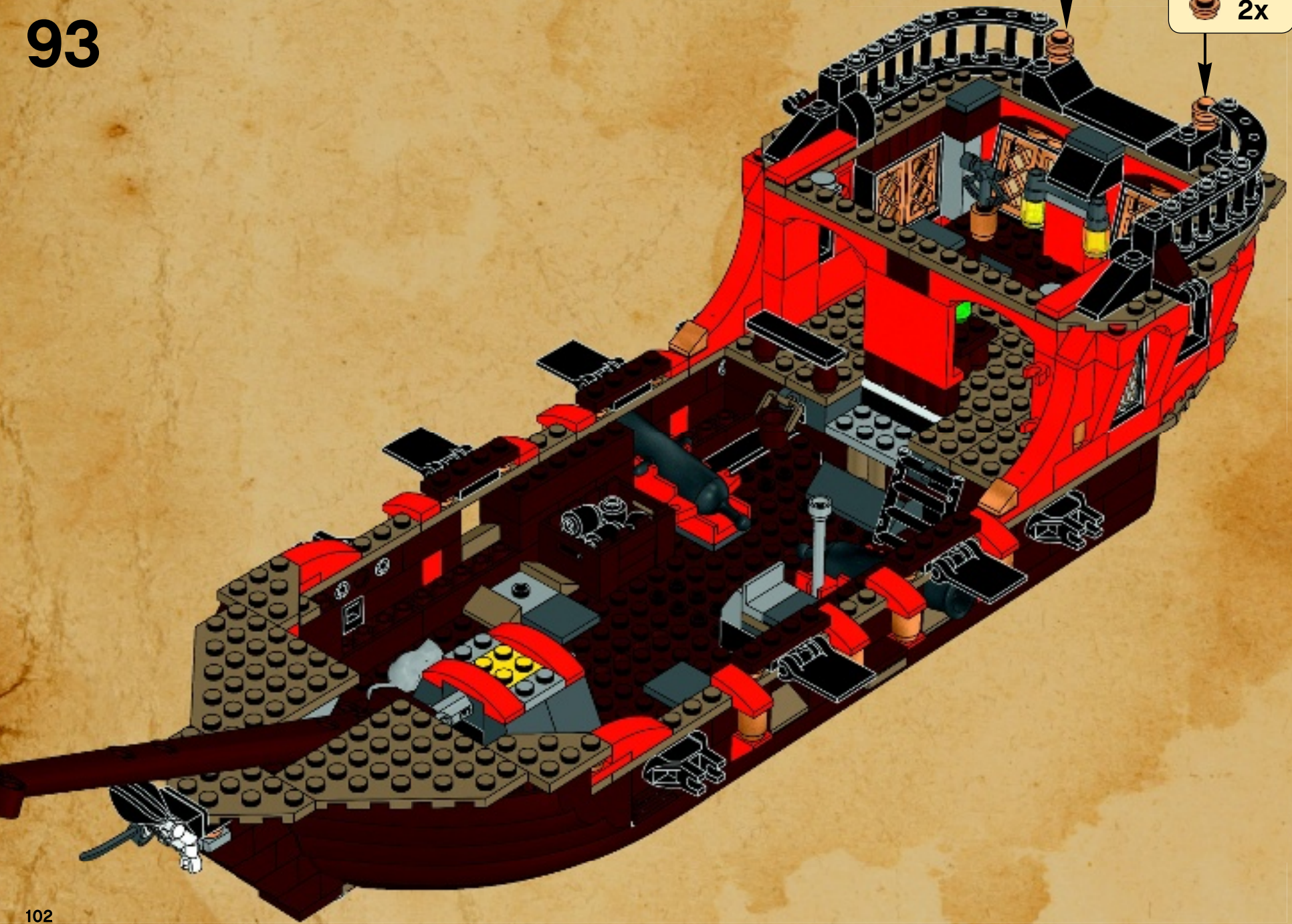



94

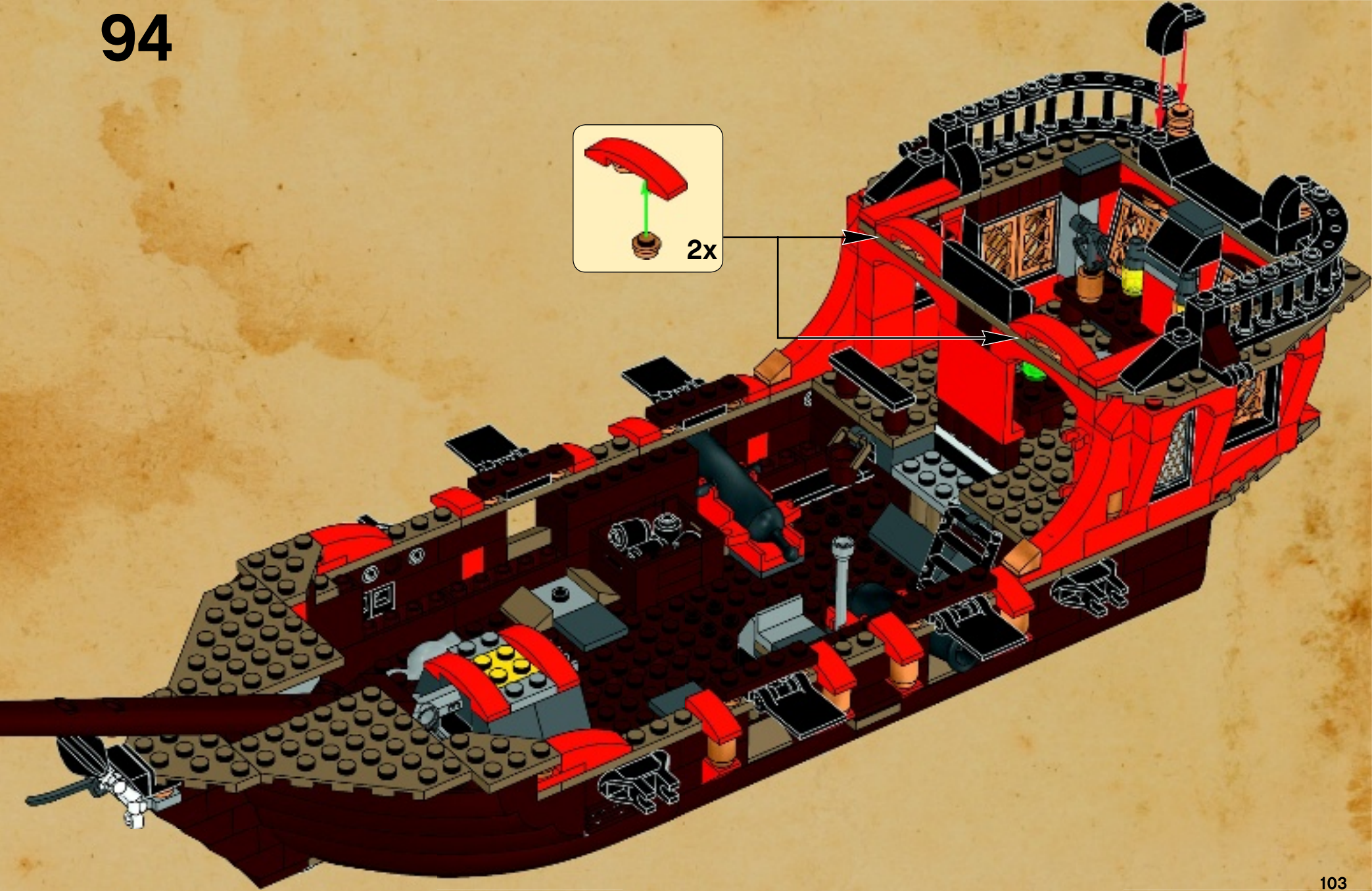
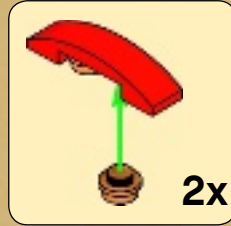

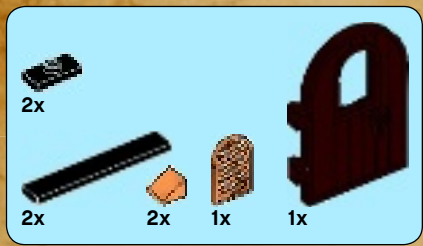

95

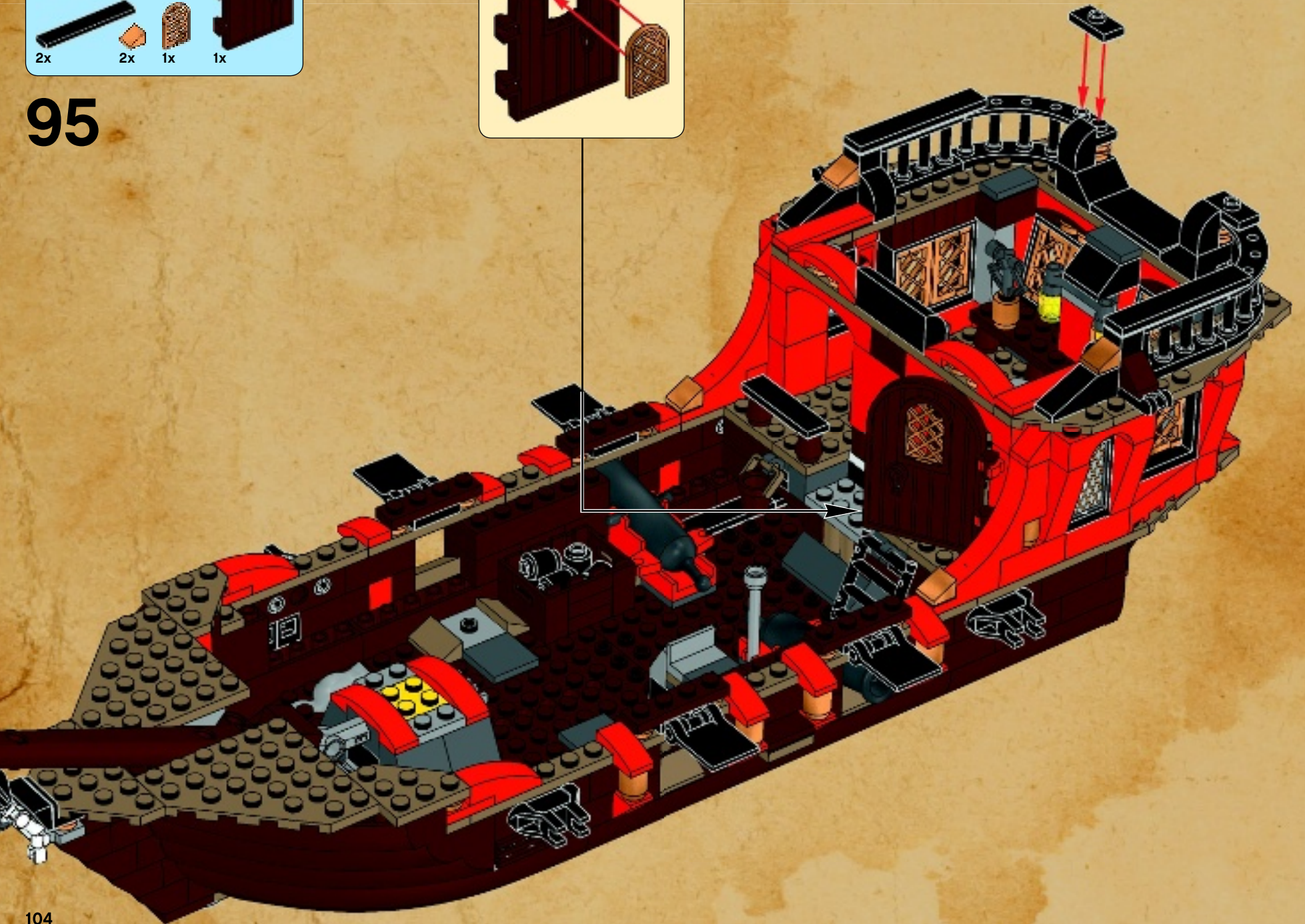





96

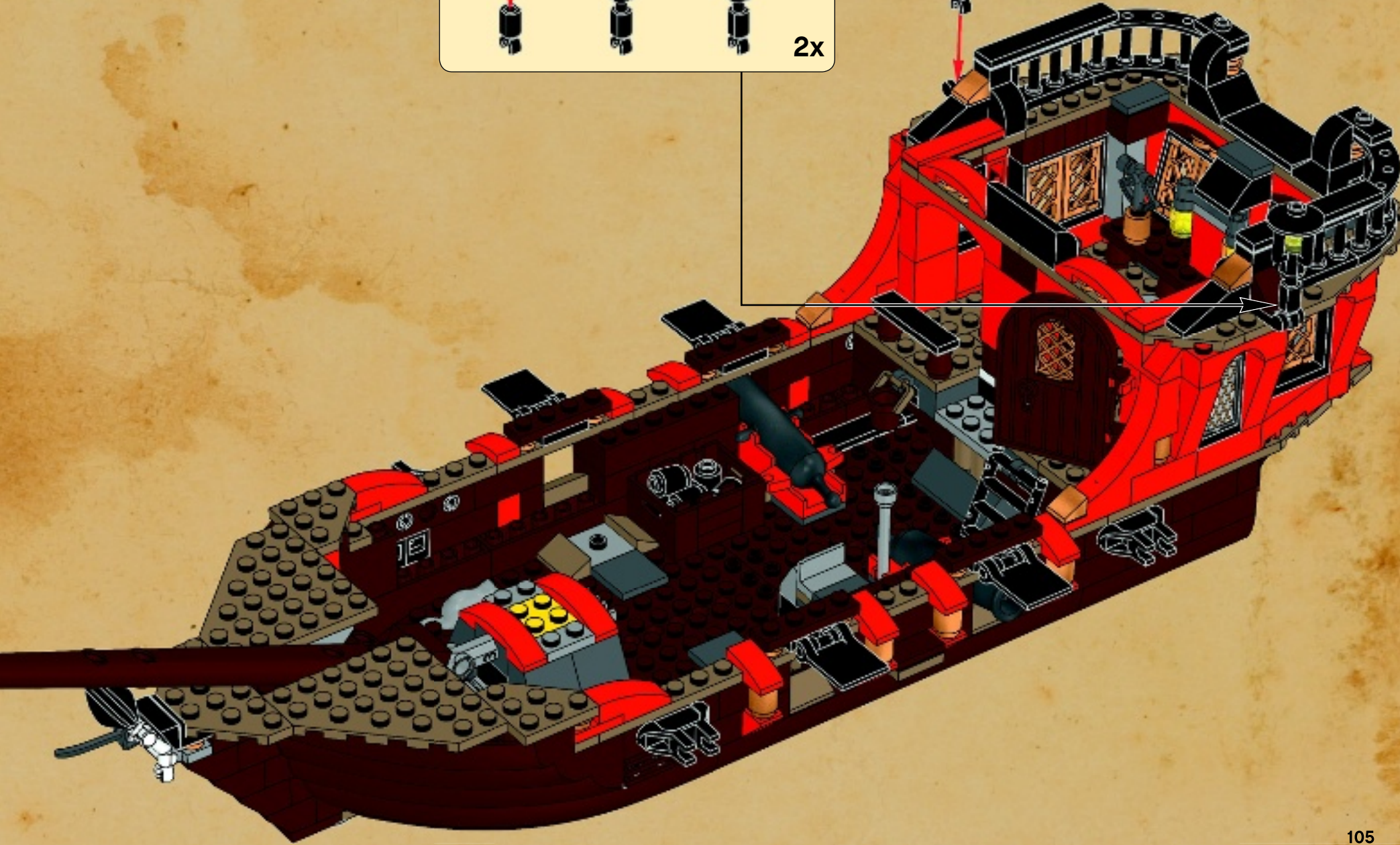
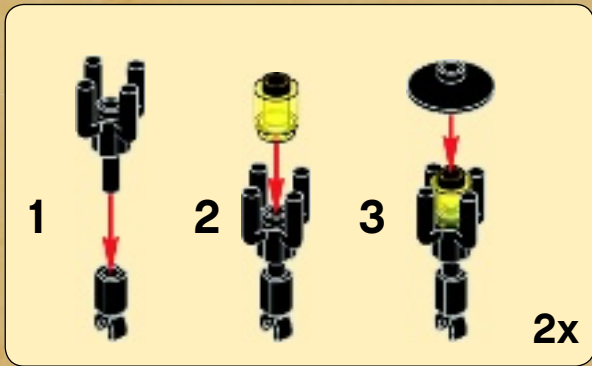

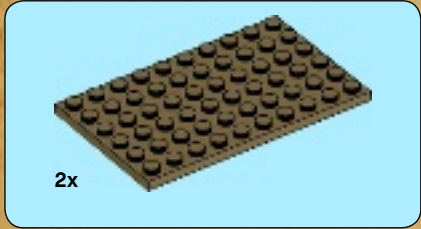

1

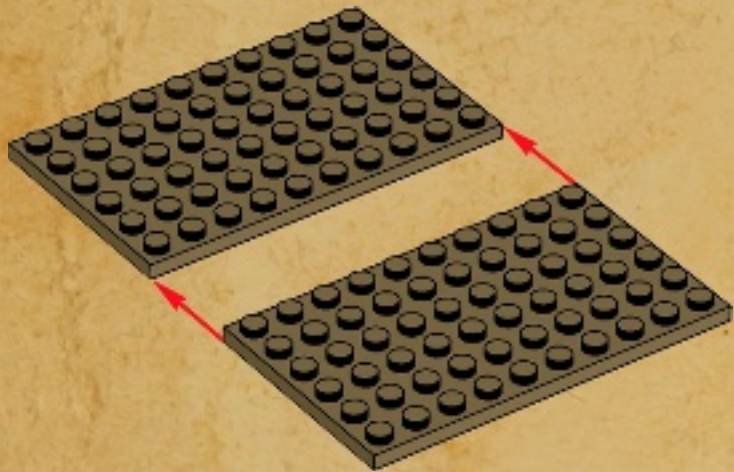

2

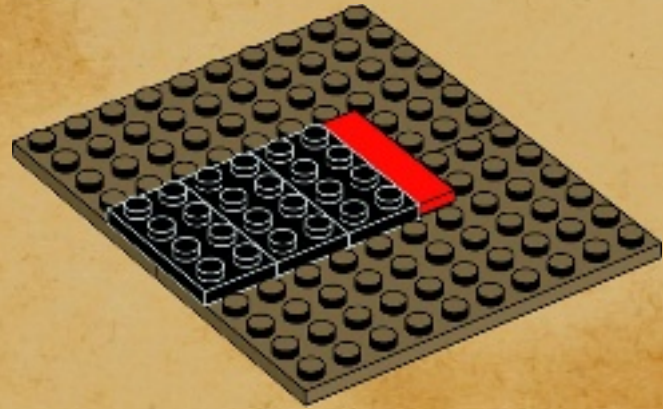

3

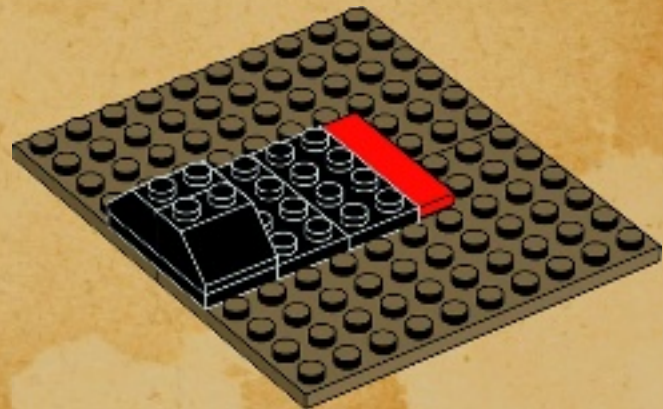



4

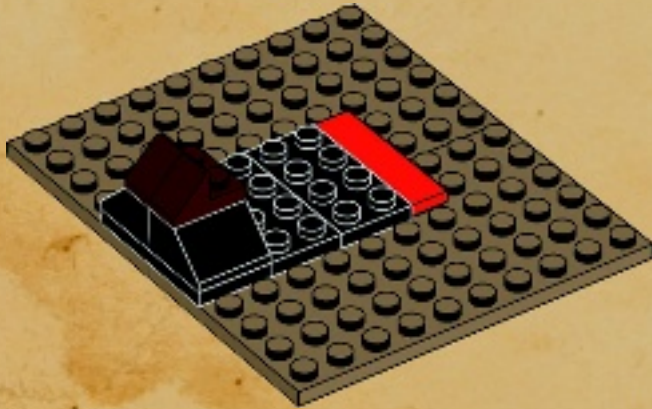

5

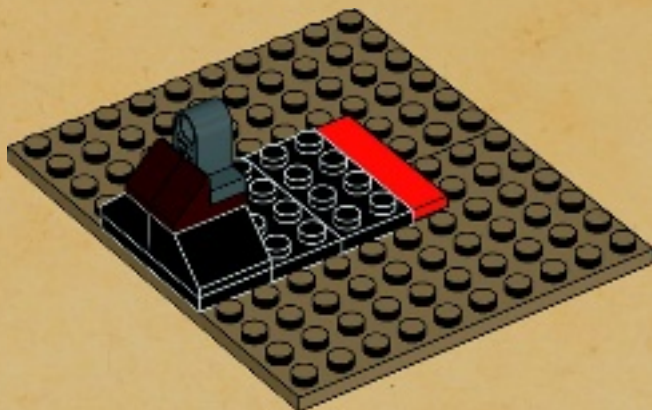

6

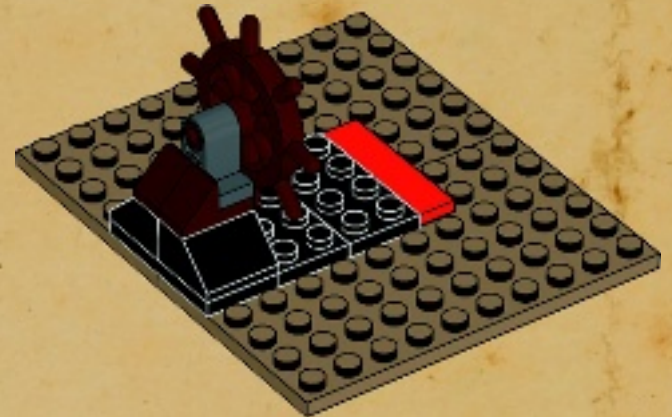

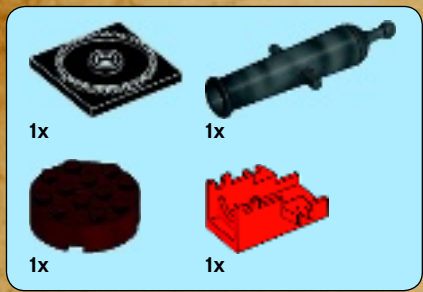

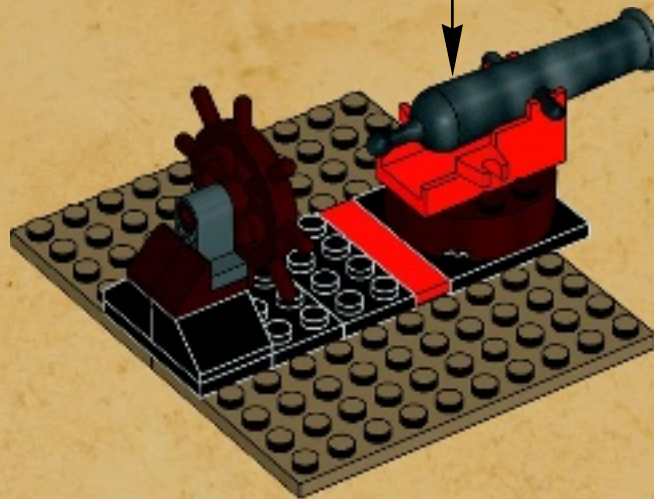
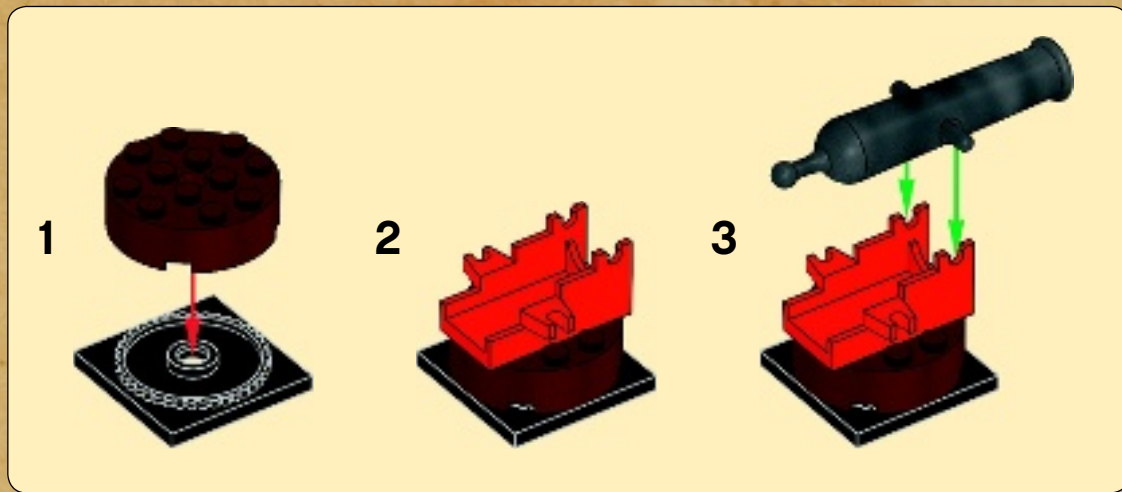

7

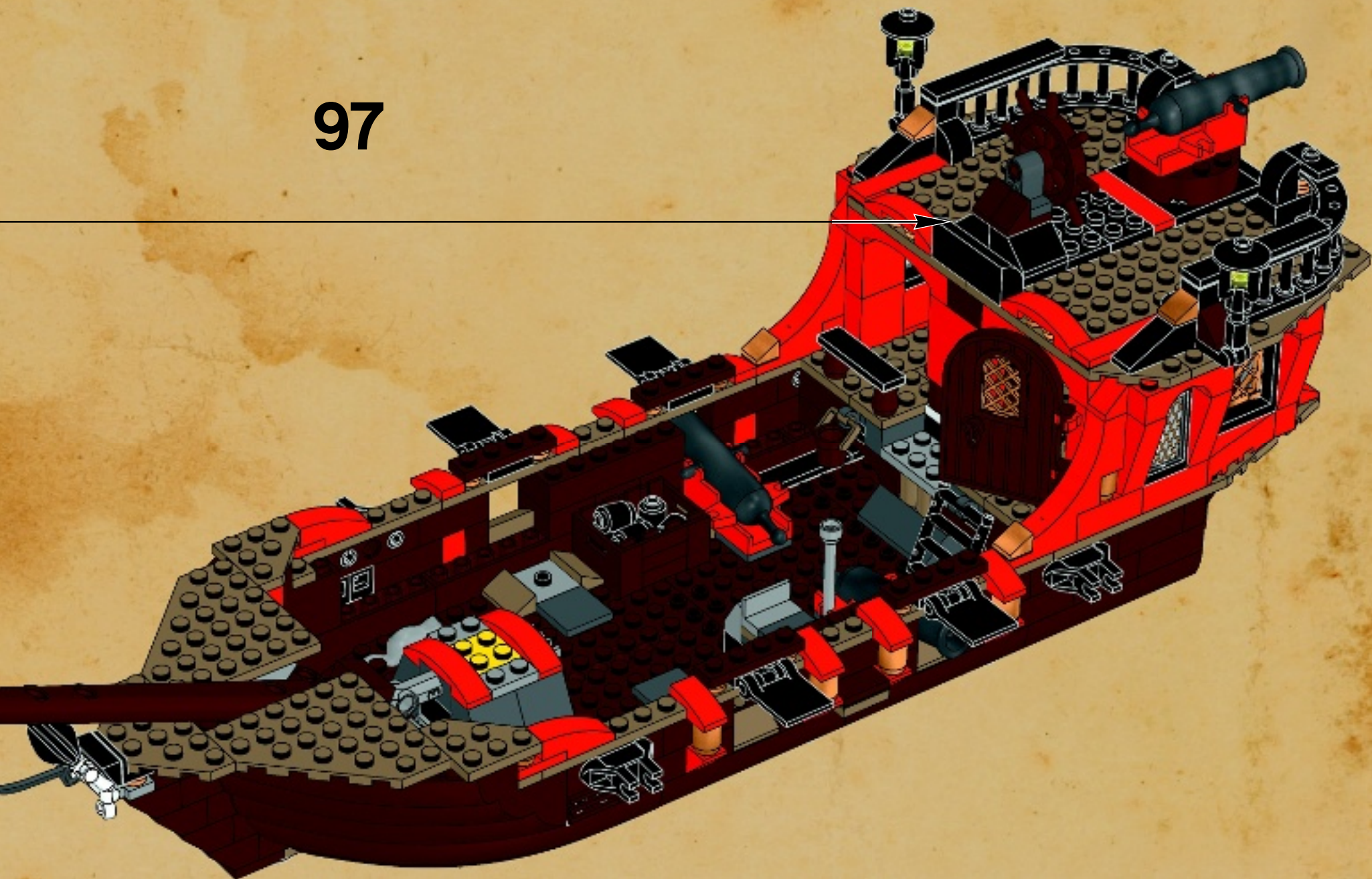

97



4x  1x 

98

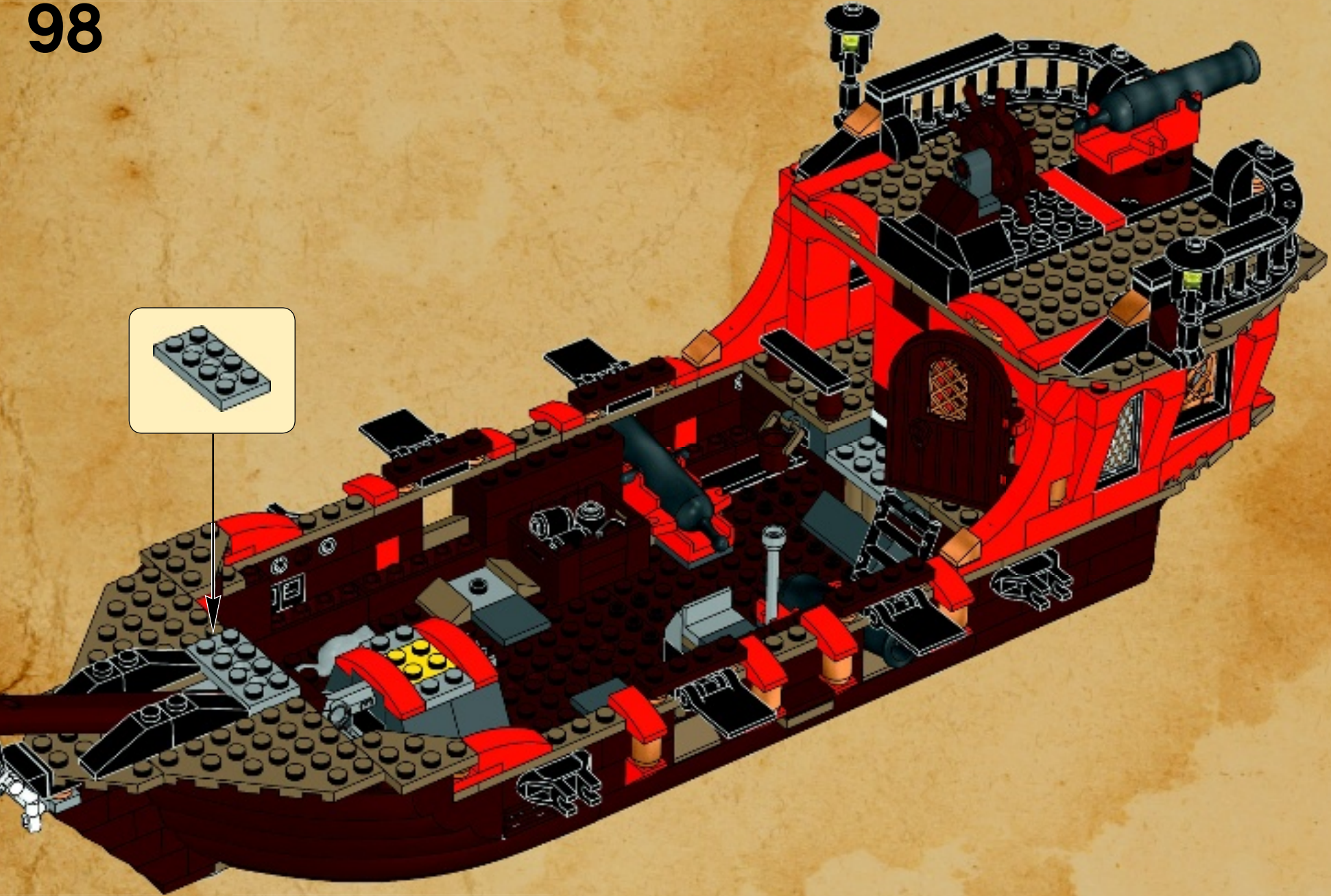



99

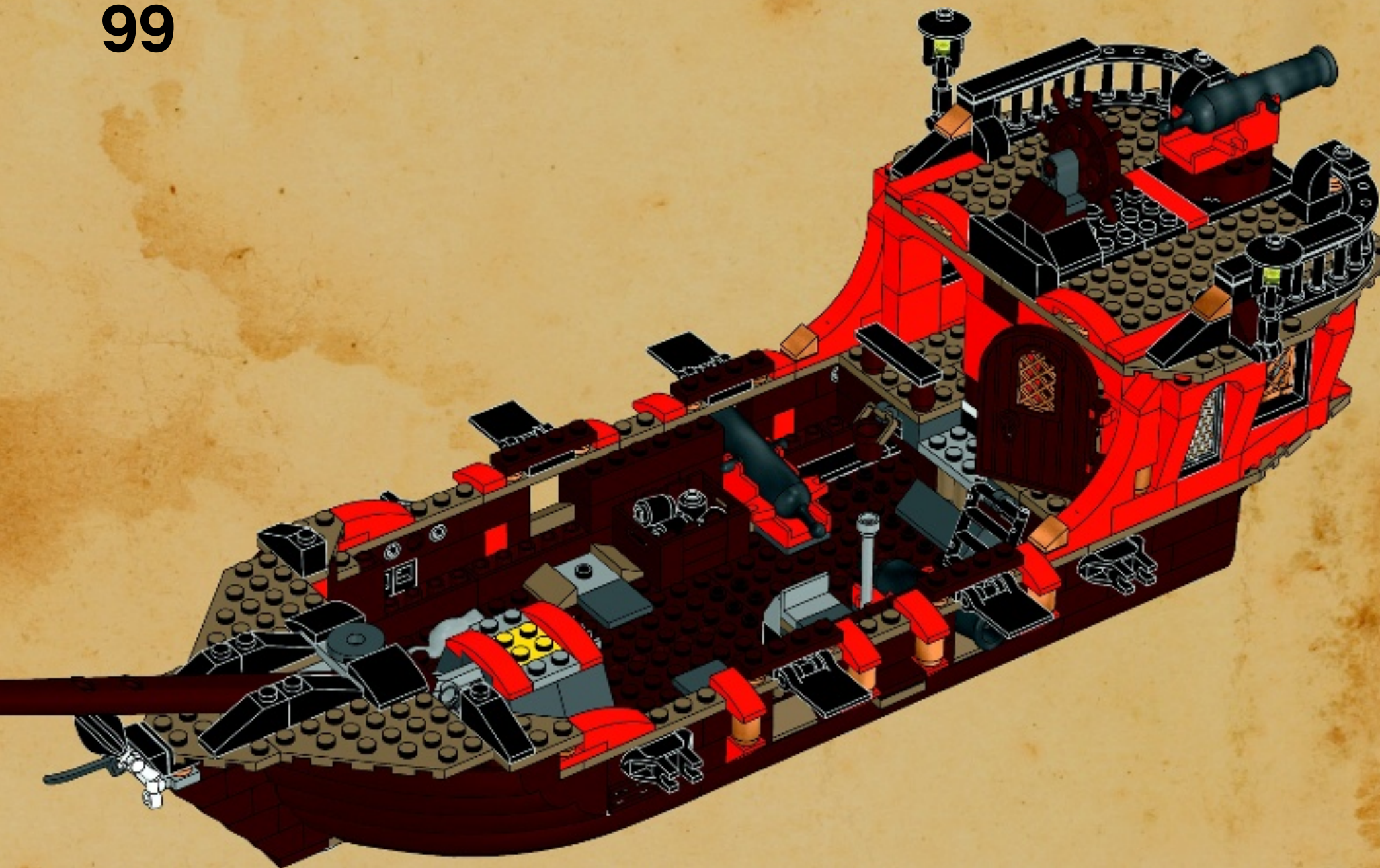



2x



1x



2x



2x

# 100

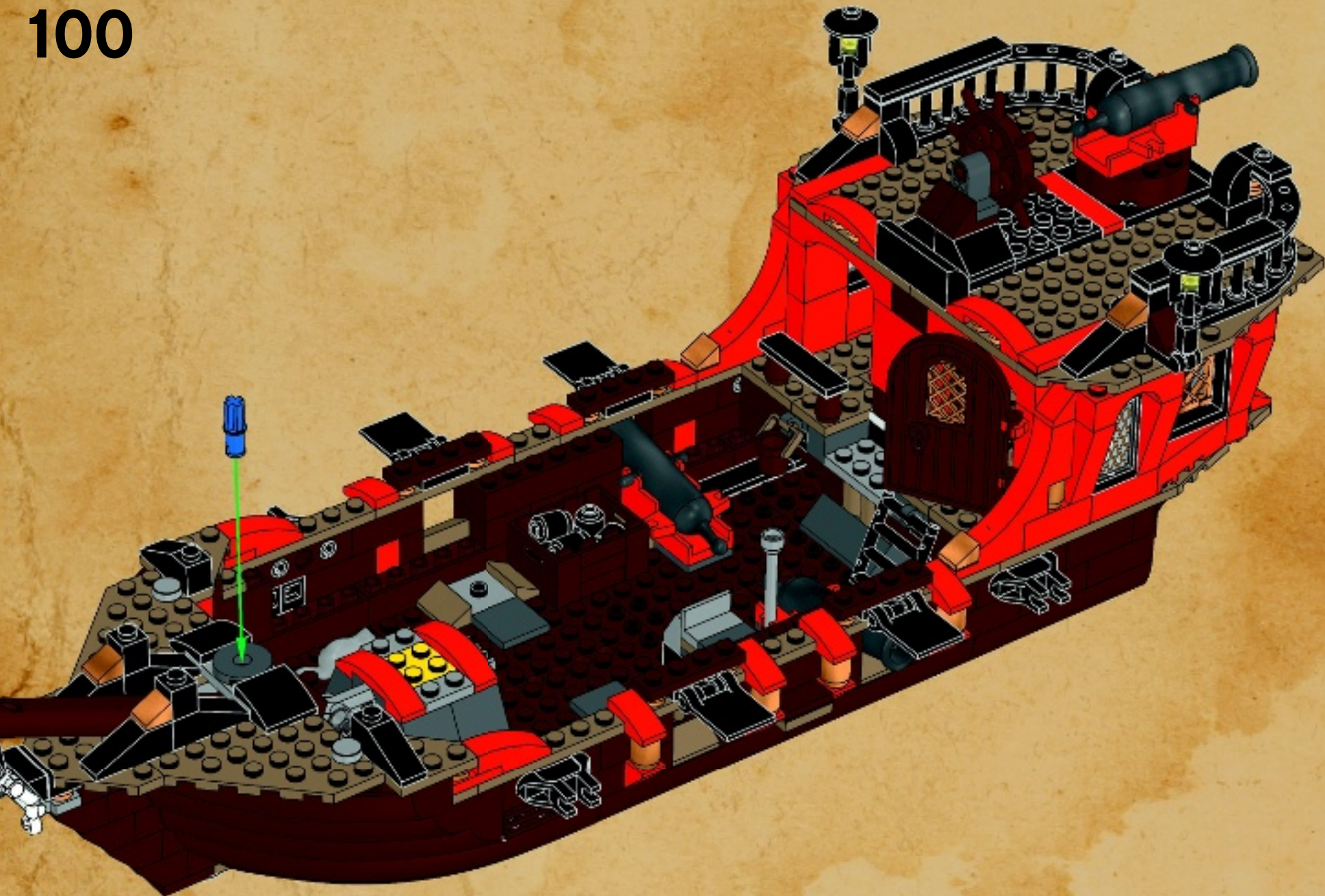





2x

# 101

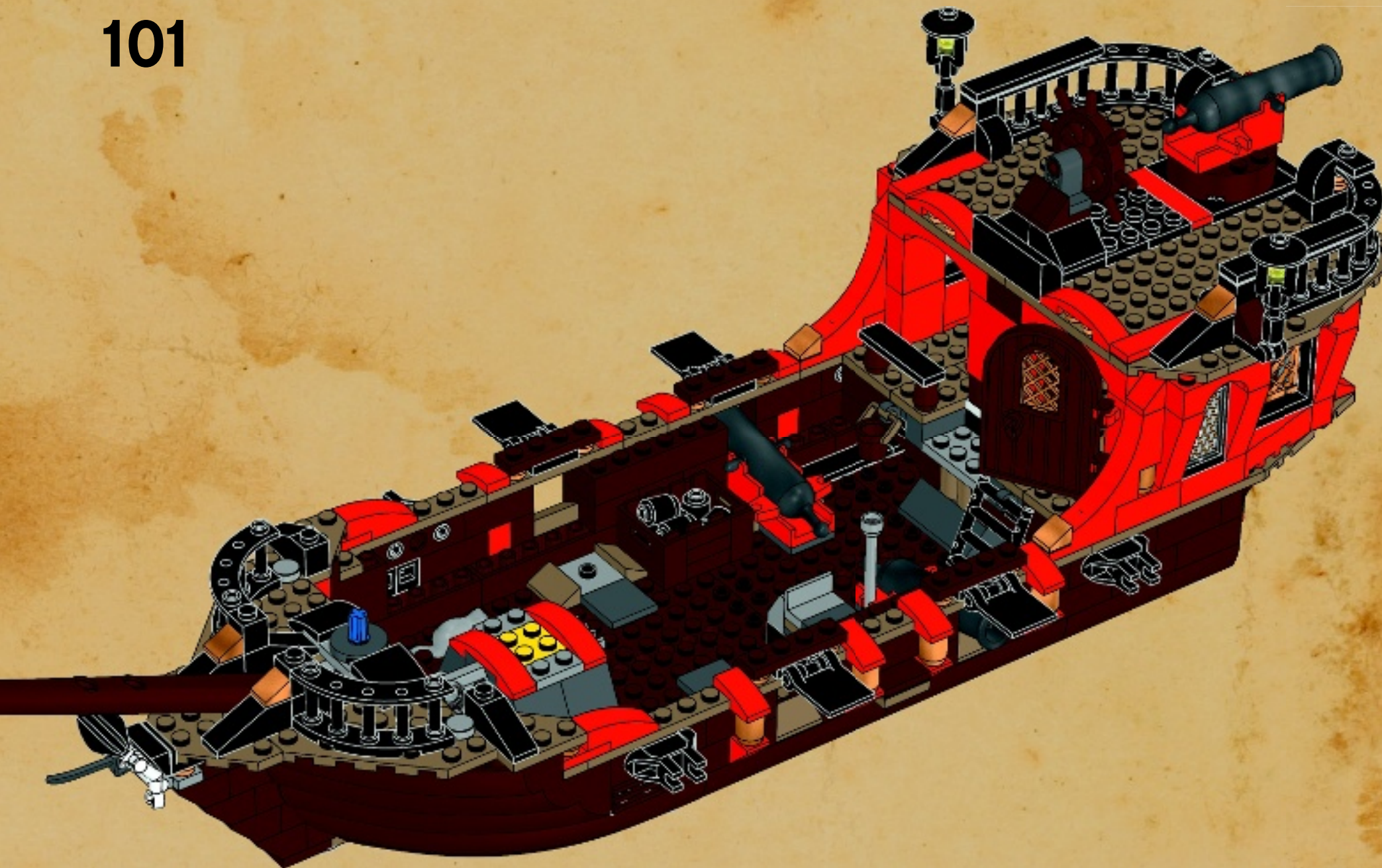

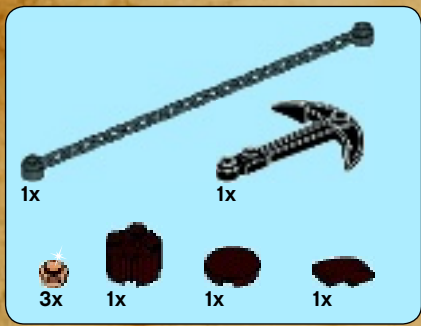

102

1



2



3



4



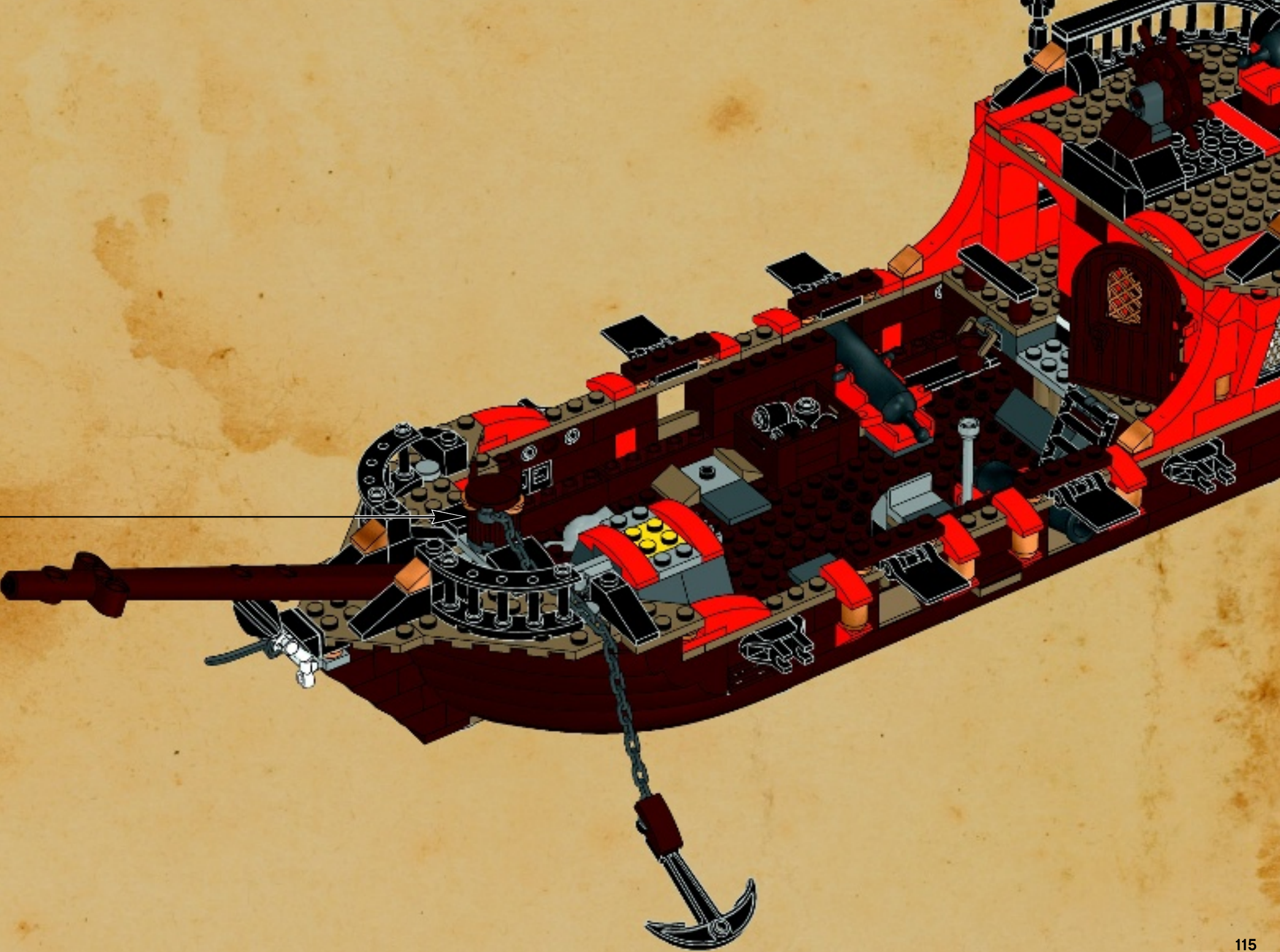



2x

# 103



2x

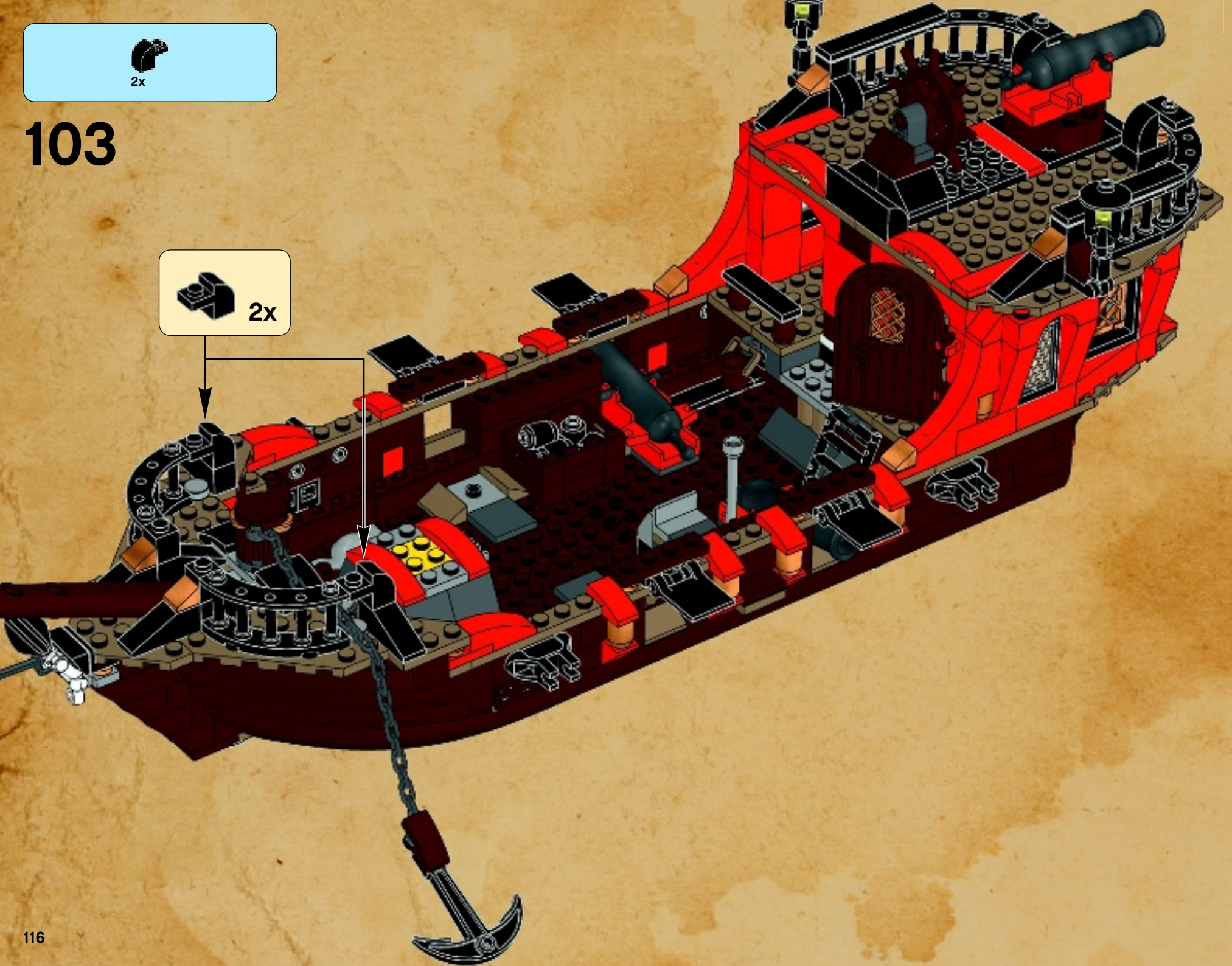



4x

# 104



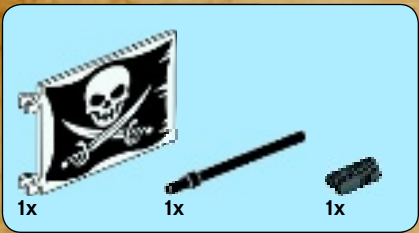

105

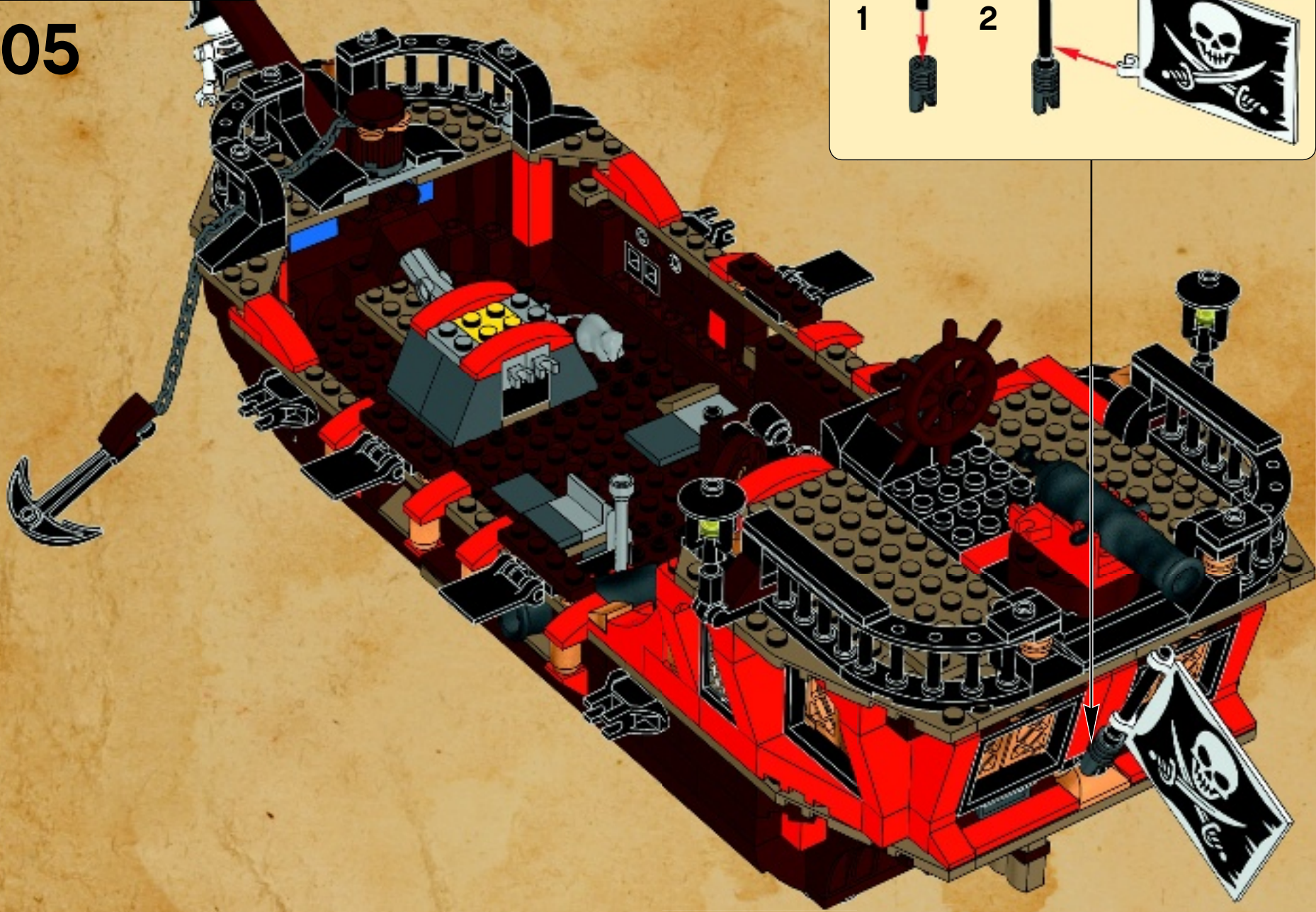
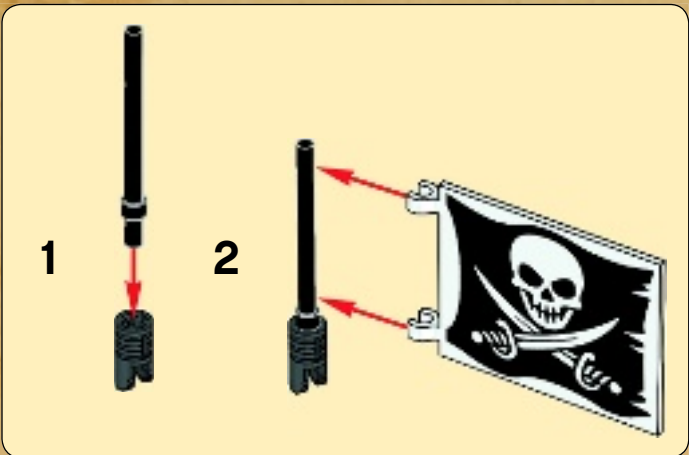

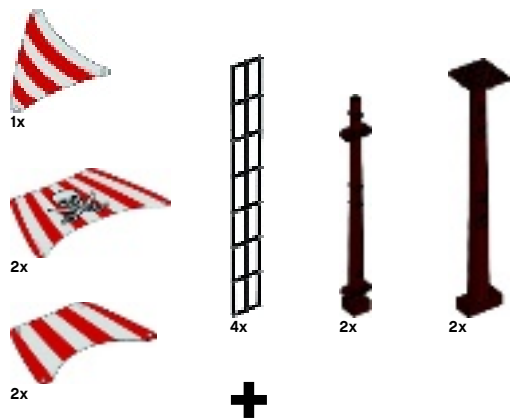

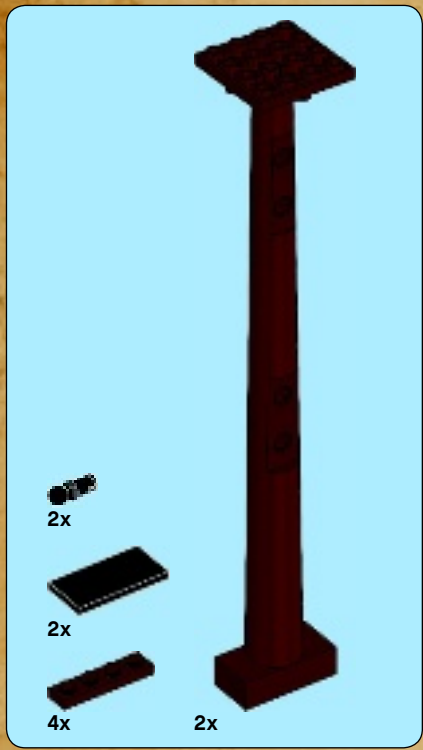

106

1



2



2x



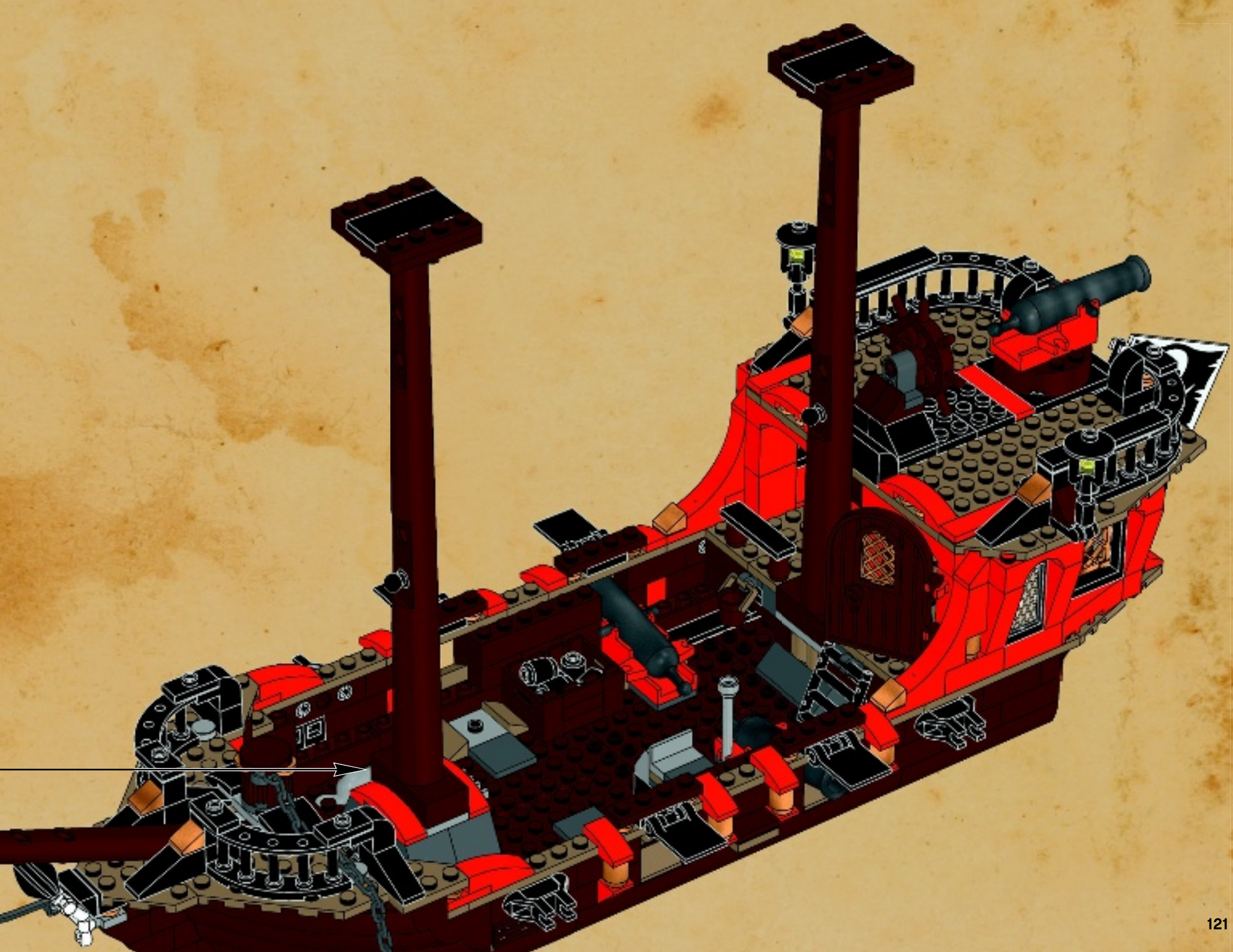

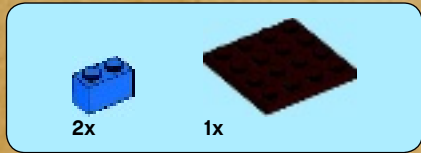

1

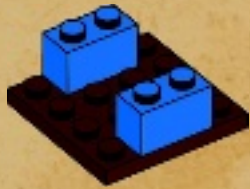

3

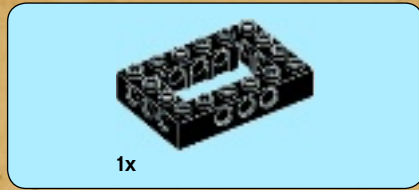

2





4

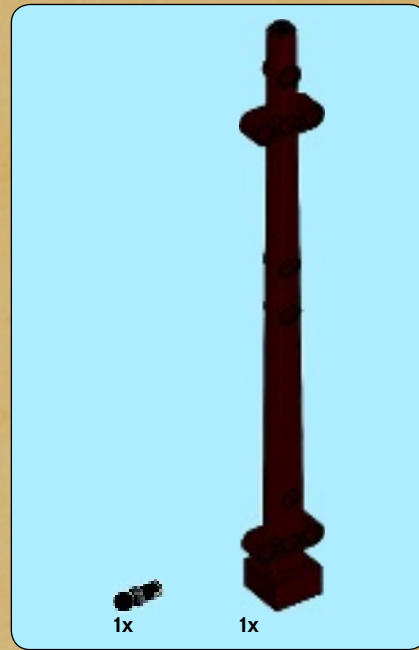
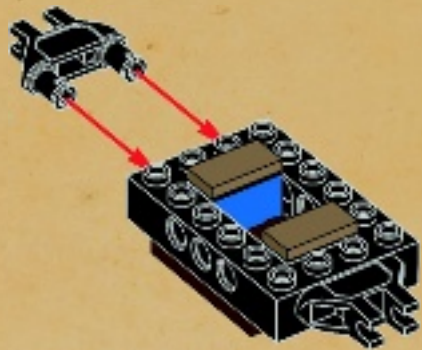

5

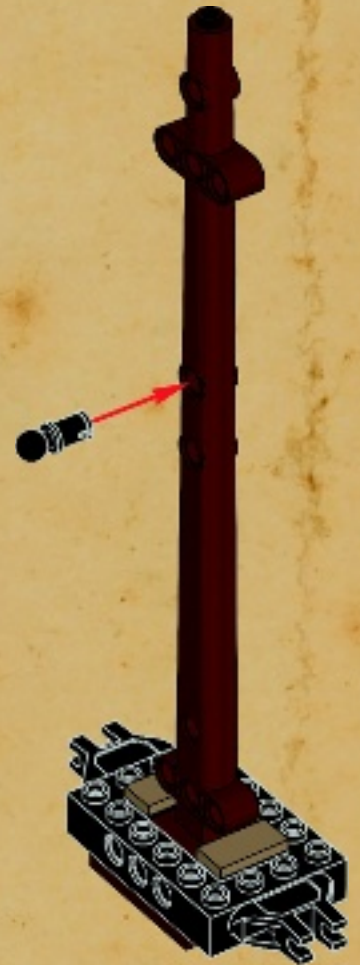



6



7





8



2x

107

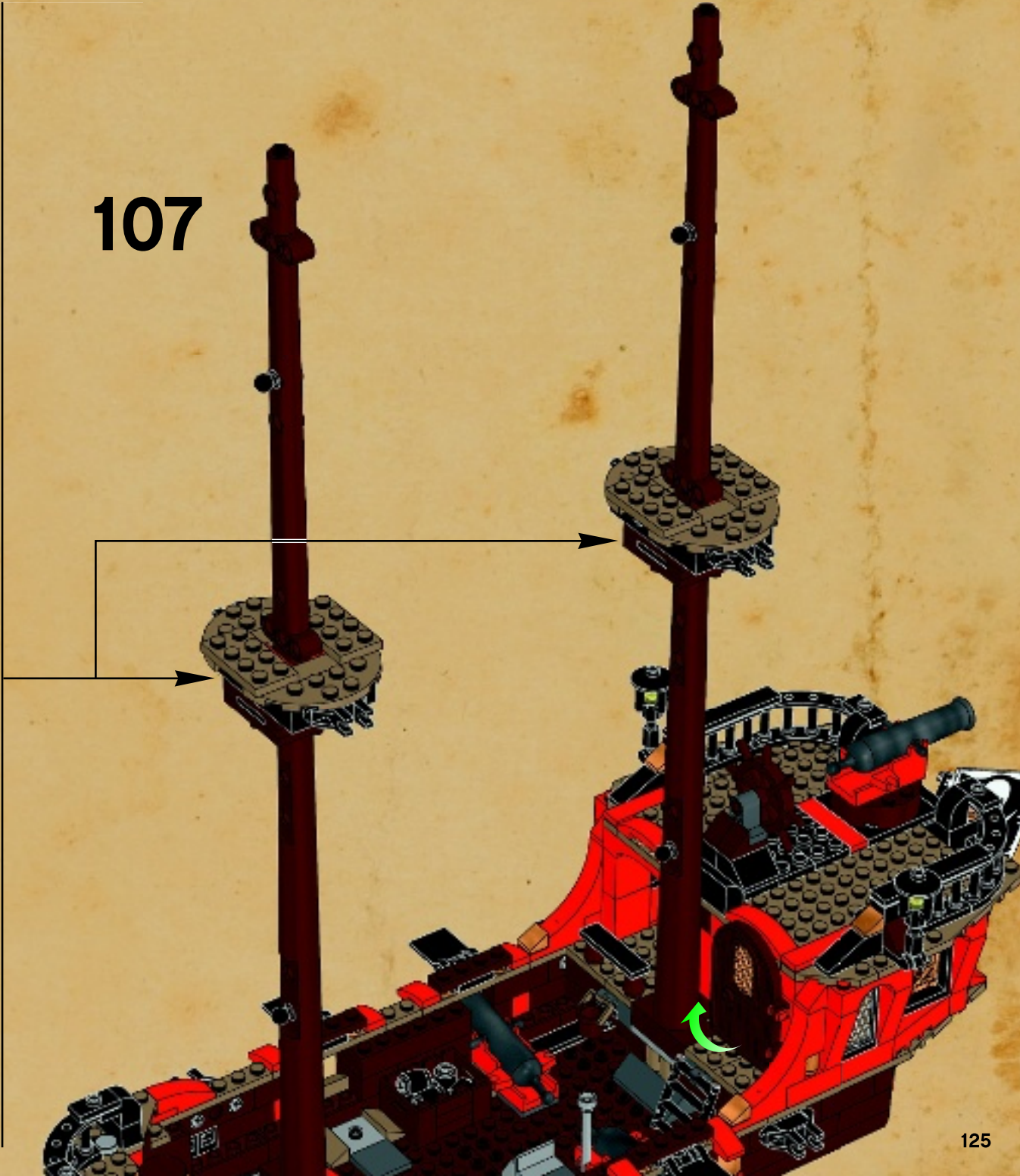

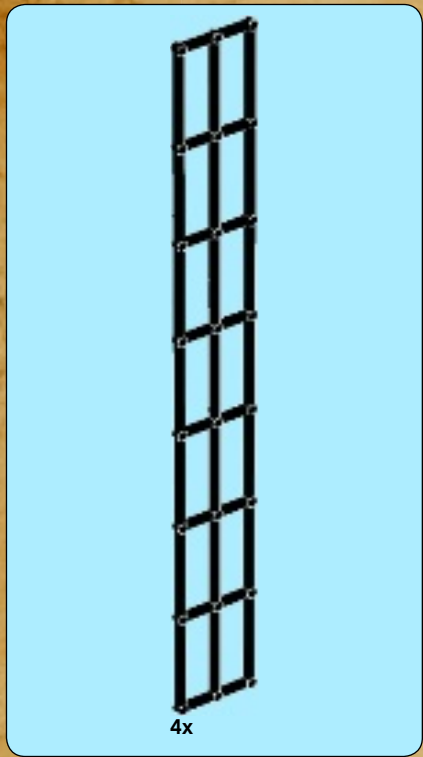

108

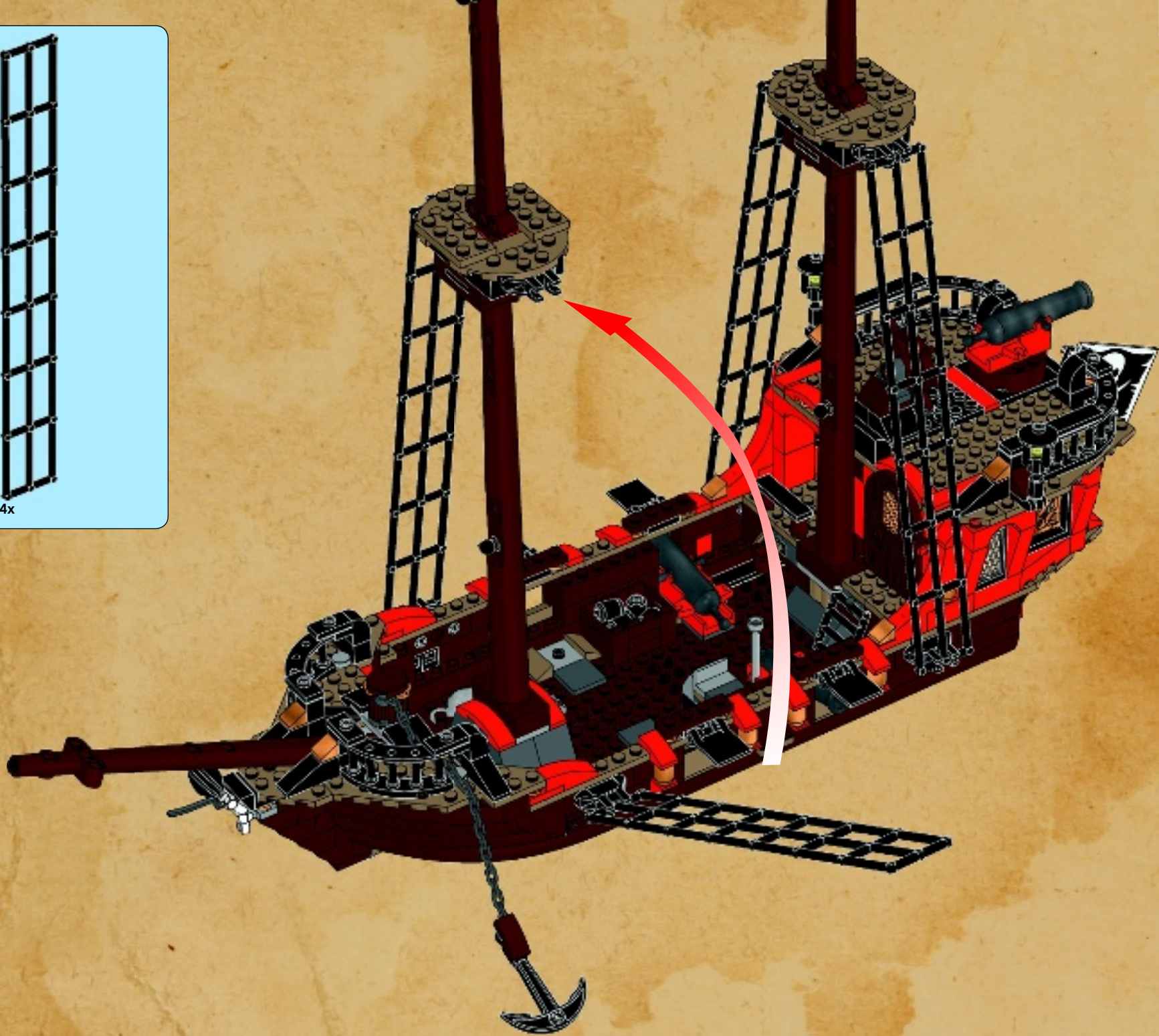

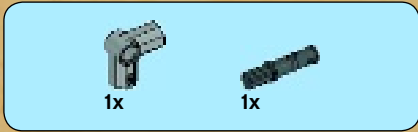

1

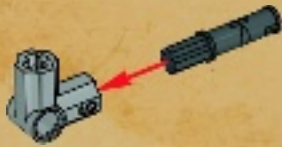

2

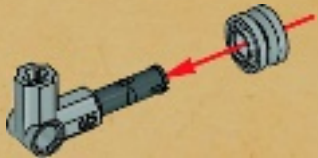

3



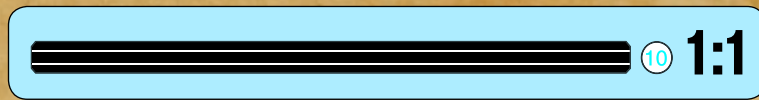
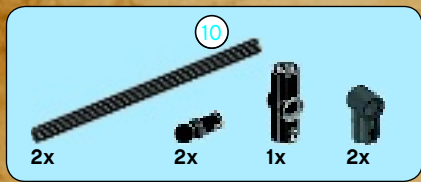

4

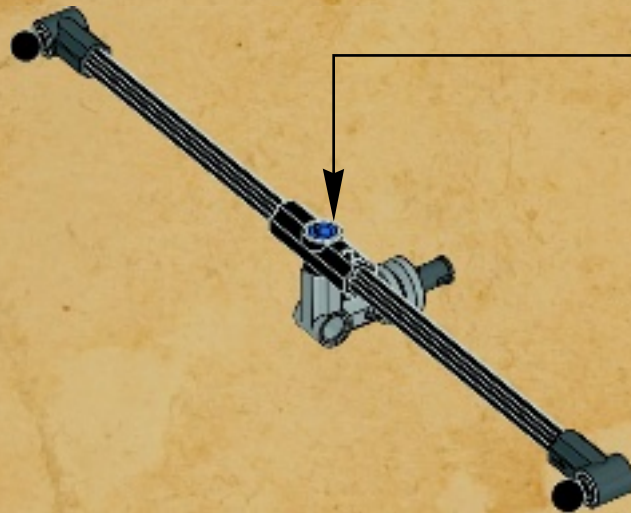
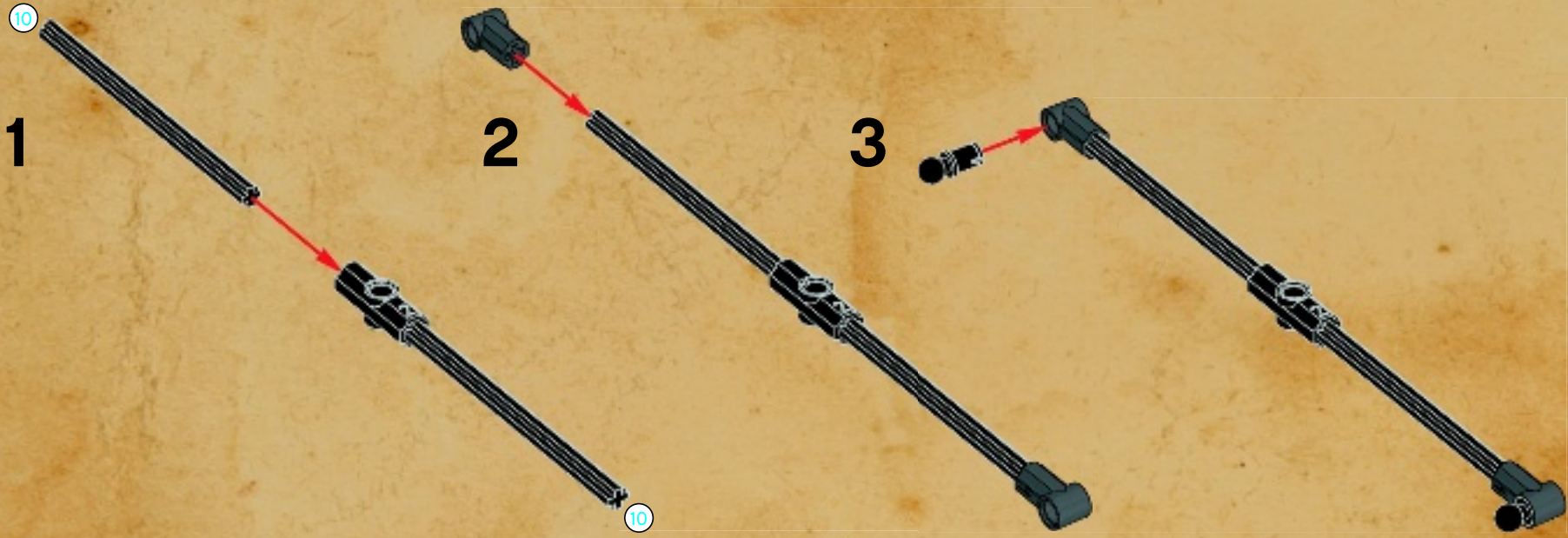



109

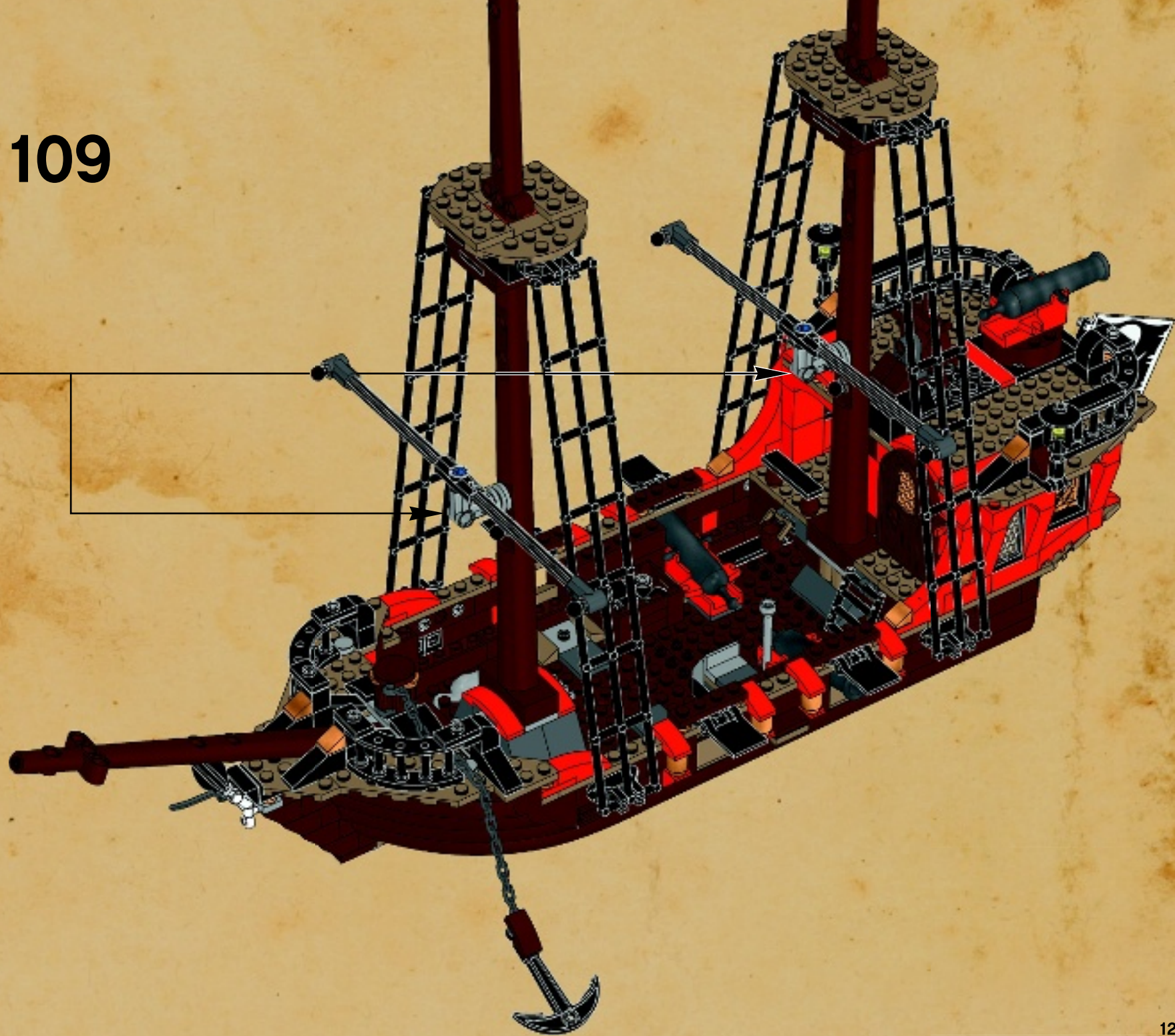

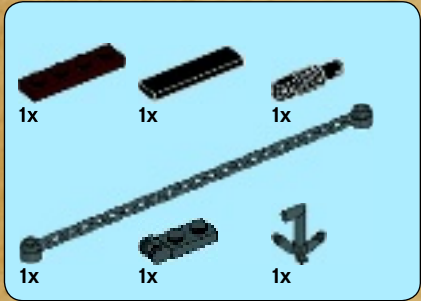

110

1



2



3



4

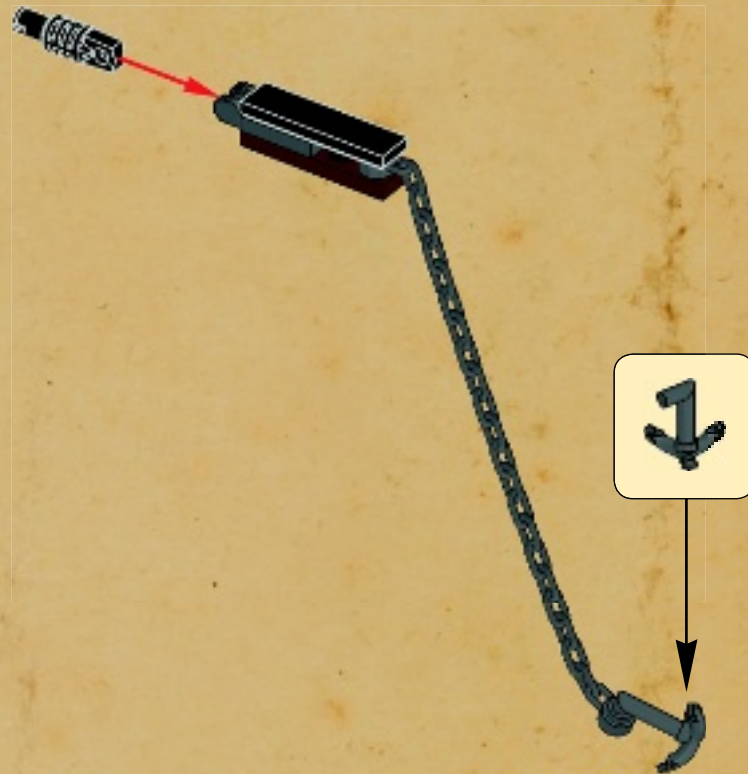

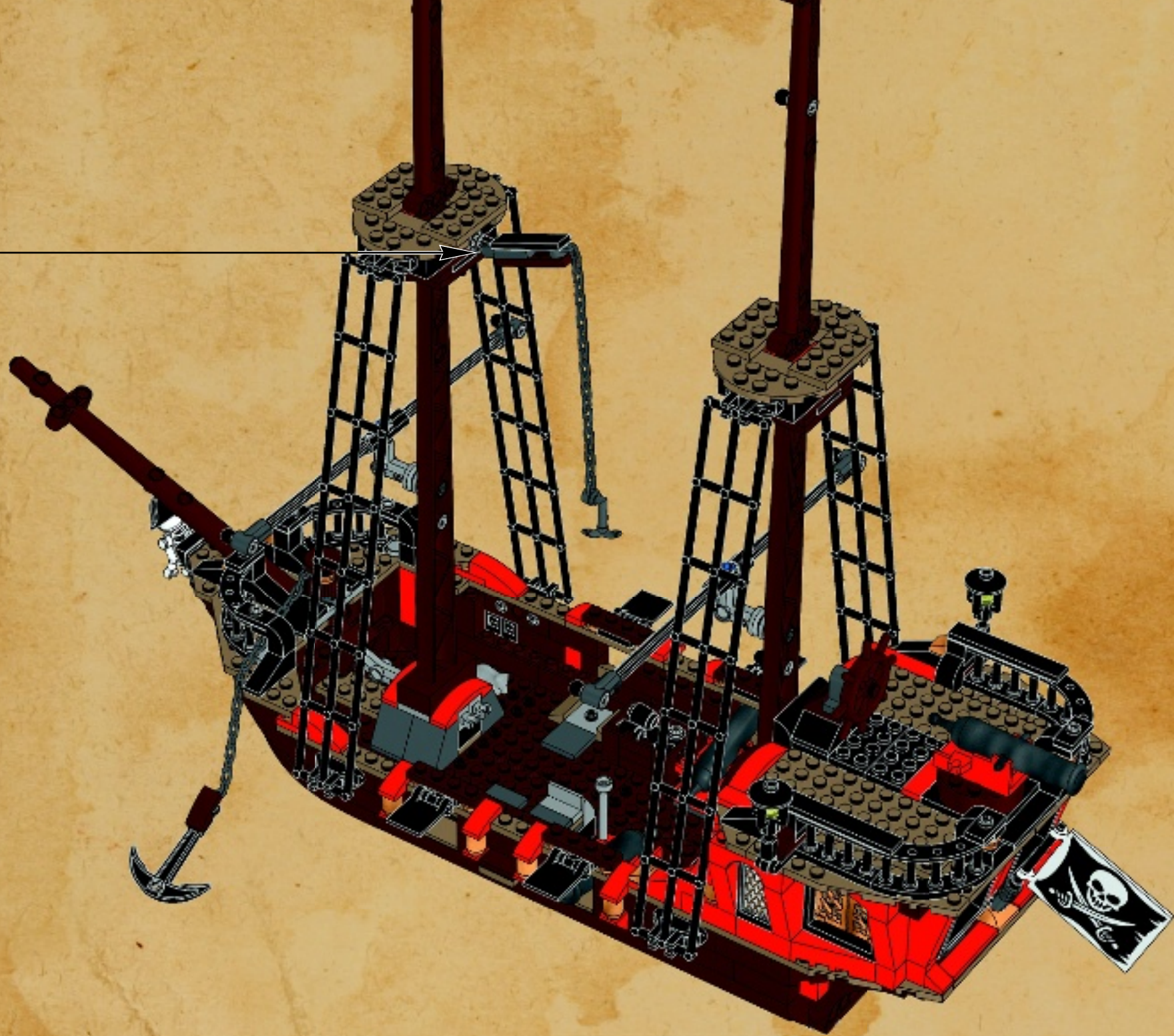

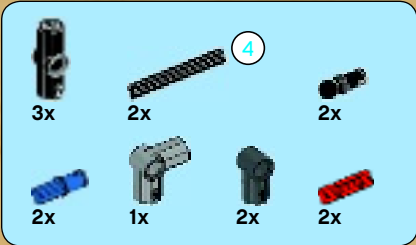

# 111

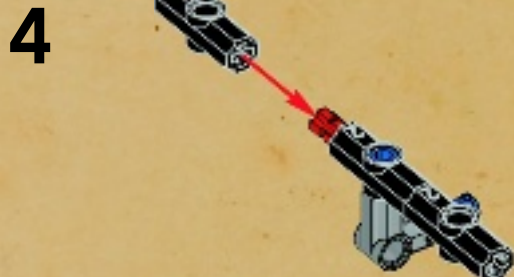
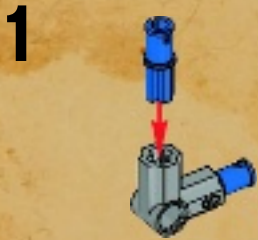

5



6

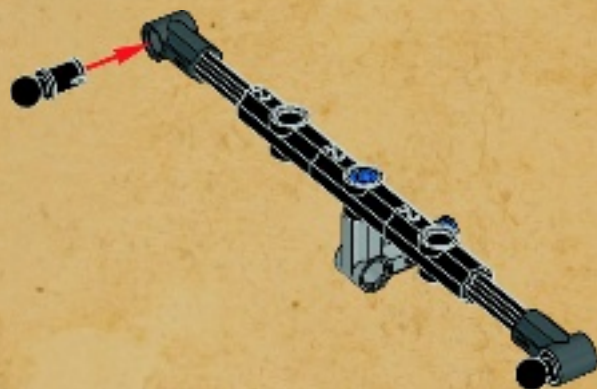

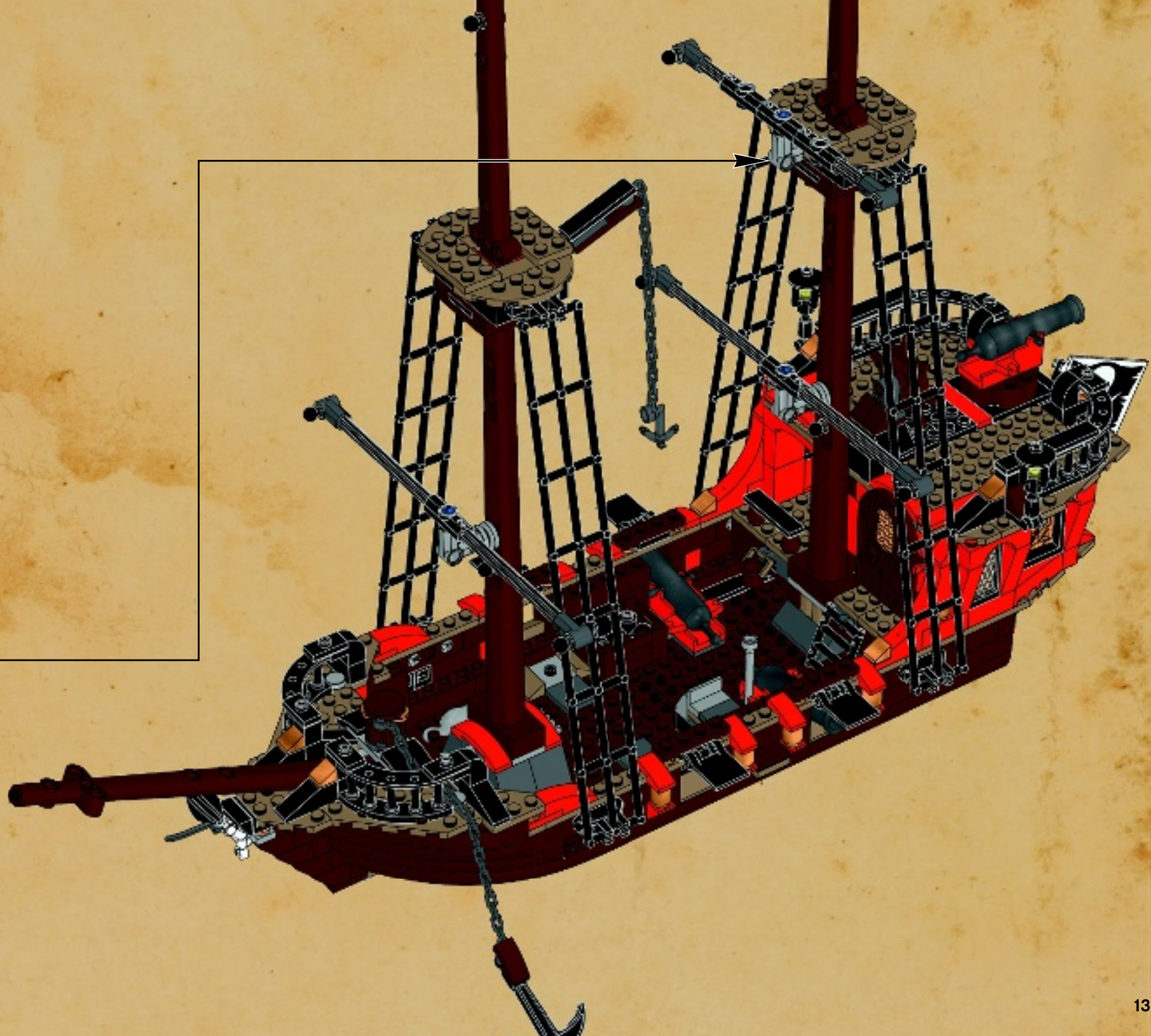



1

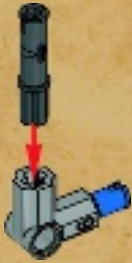

2



3



4





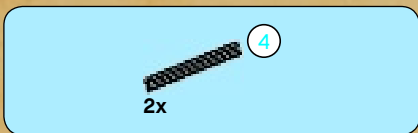

5



6

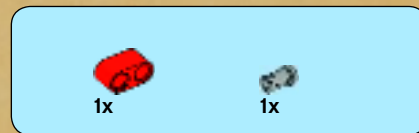
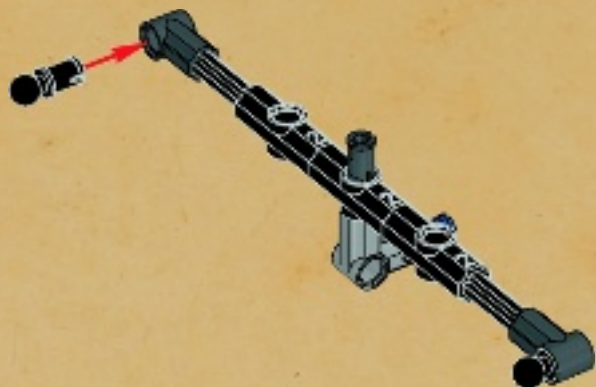

7

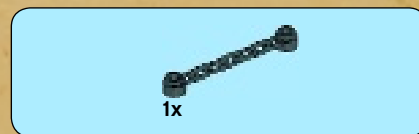
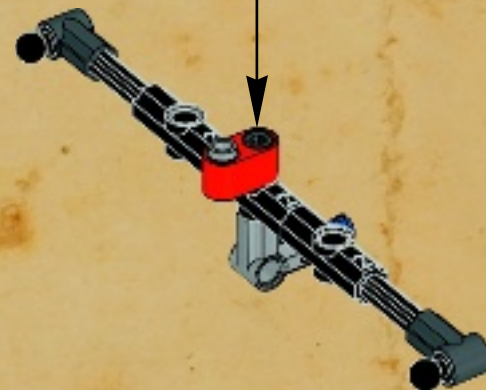

8

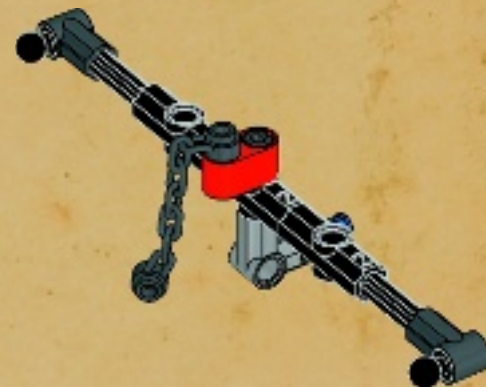

112





4 1:1

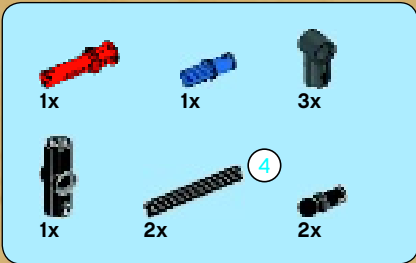

113

1



2



3

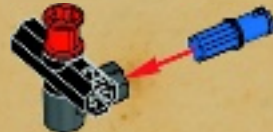

4

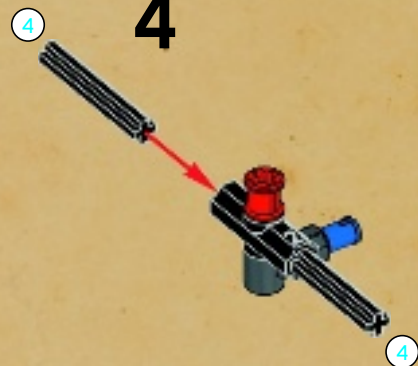

5





1

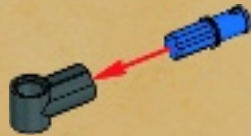

2

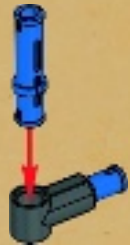

3

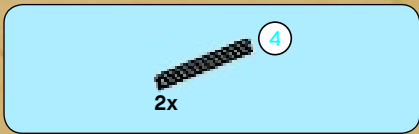

4

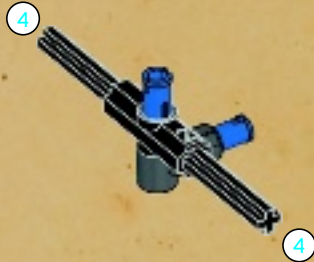

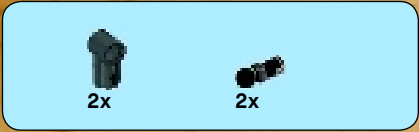

5



6

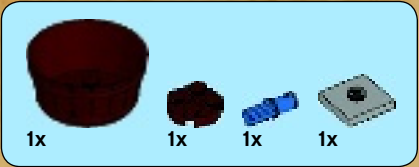

7

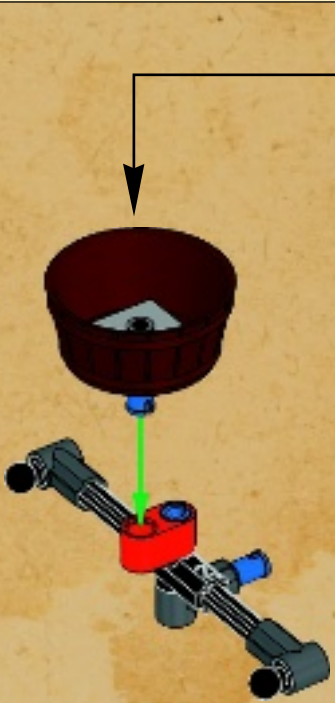
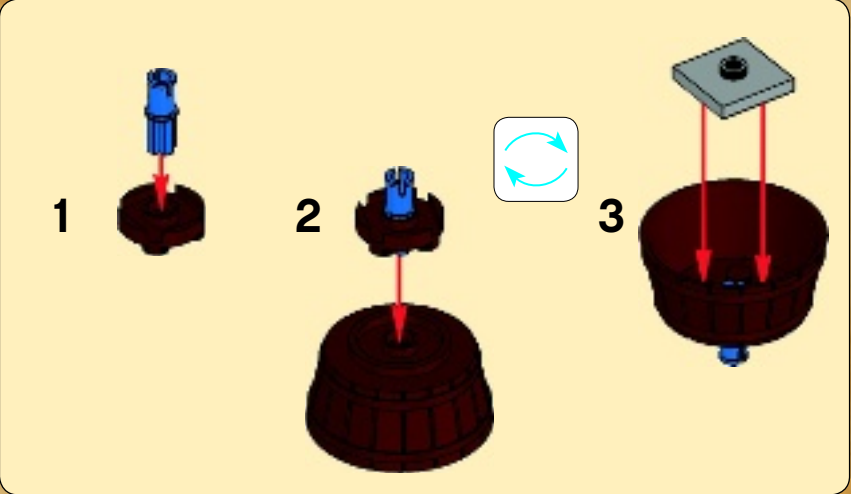

114

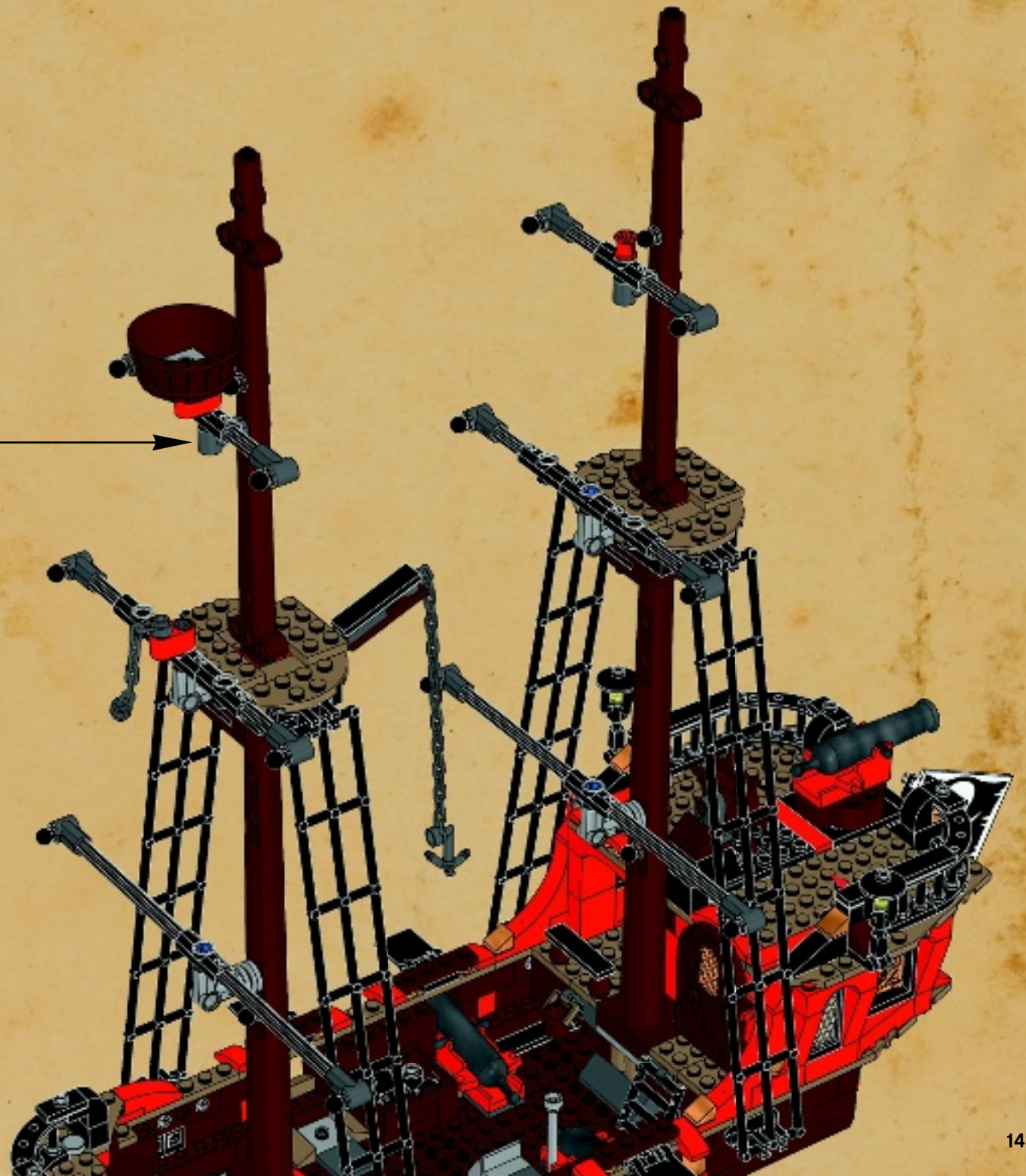

-  1x
-  1x
-  1x
-  1x

# 115

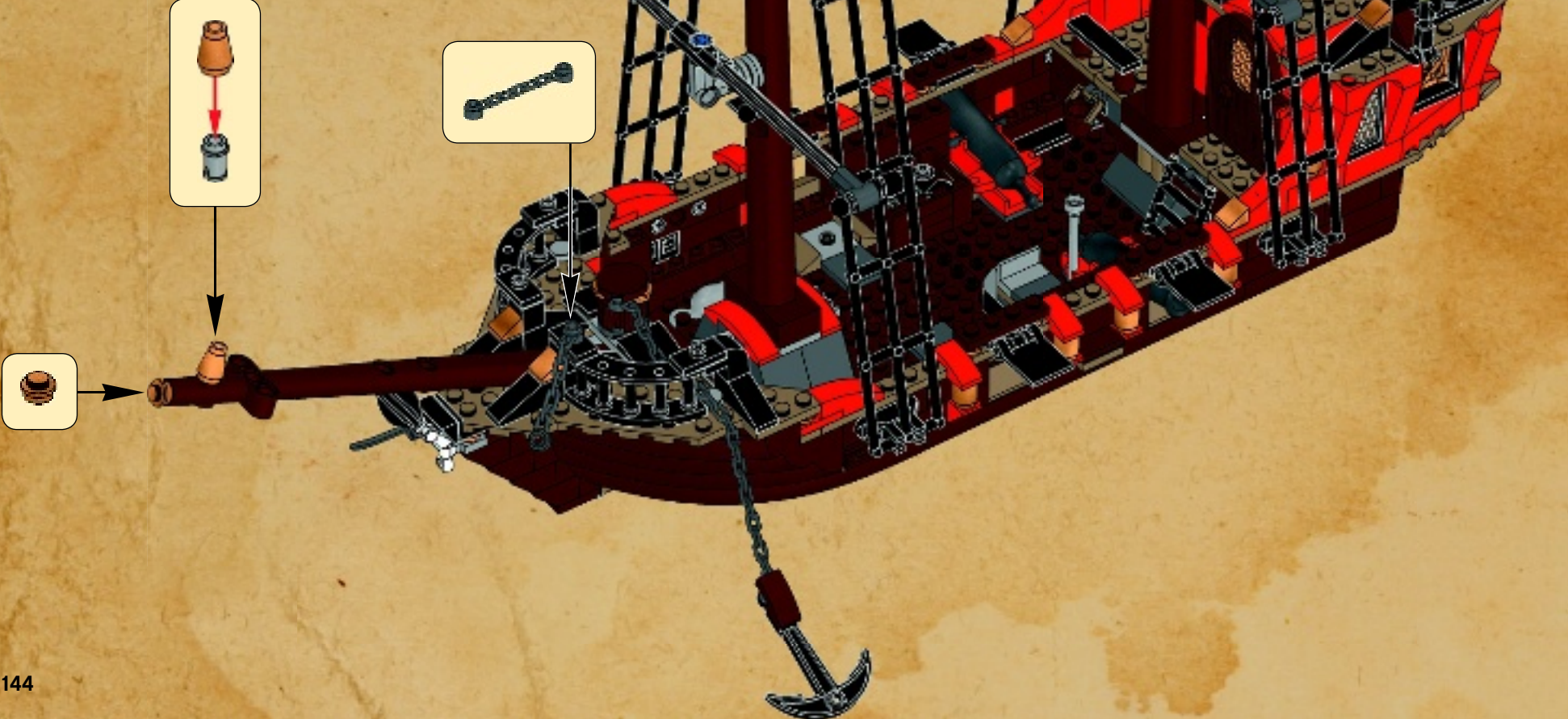



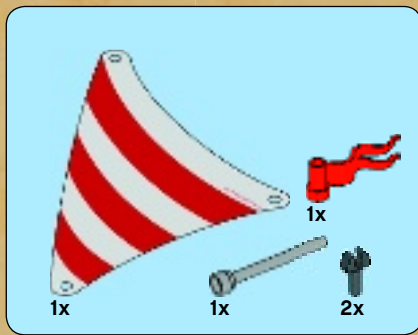

116

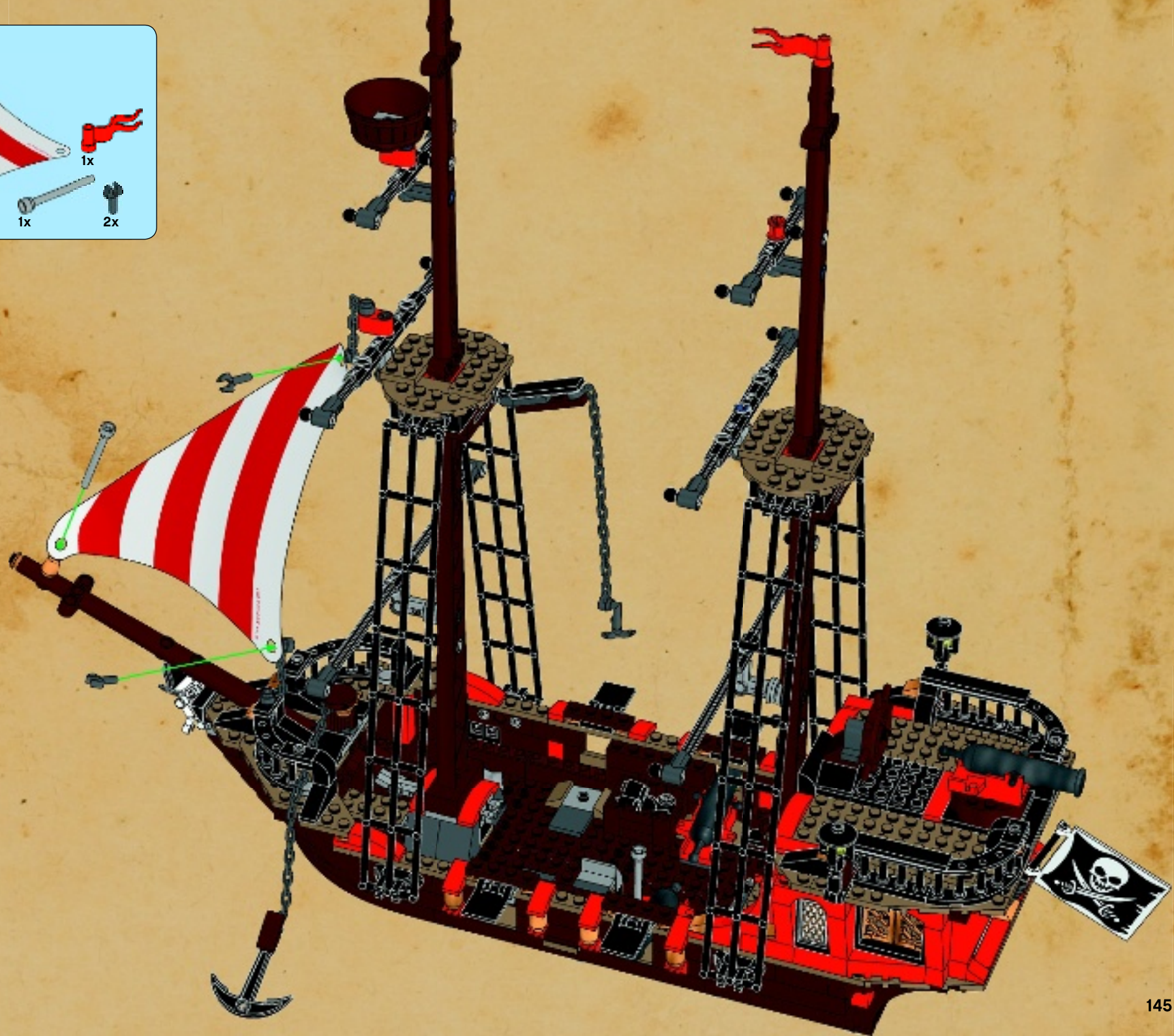



117



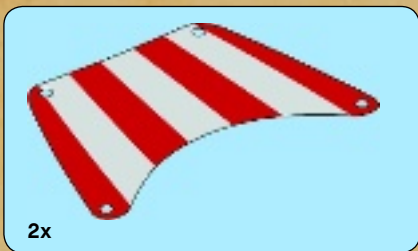

118



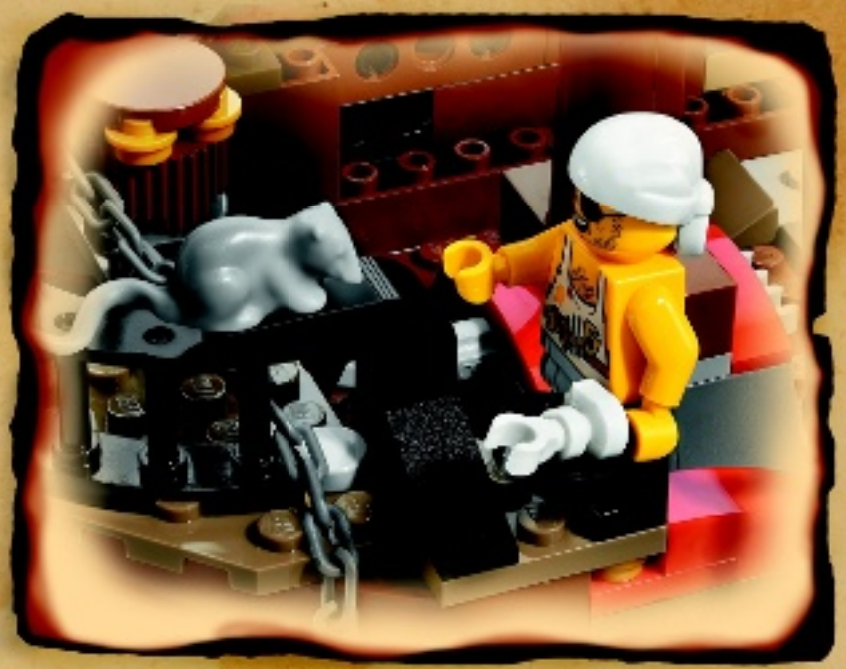



1x  
371001



1x  
6097118

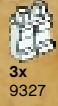

3x  
9327



1x  
6097241



1x  
4651445



1x  
6097475



1x  
6097193



2x  
6038450



2x  
6037870



1x  
4508143



2x  
6096981



1x  
6100077



2x  
6061700



3x  
4143832

2x  
235721



2x  
365921

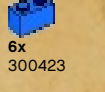
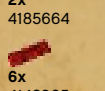
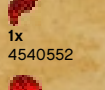
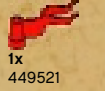
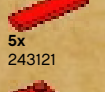

6x  
300423



6x  
306226

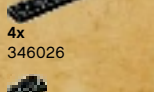
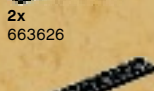
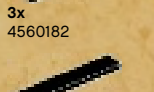
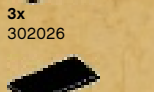
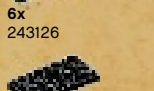
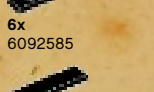
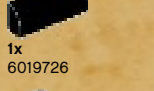
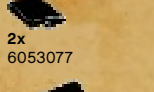
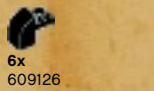
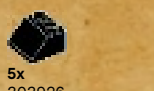
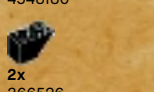

2x  
4550017

1x  
4185620



4x  
6071335

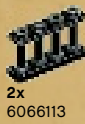

1x  
4159335

2x  
393826



1x  
4654448

5x 4520257  
 12x 6015449  
 6x 4528604  
 4x 4496699  
 5x 6035540  
 2x 4626904  
 7x 4267874  
 8x 6015424  
 3x 4550329  
 3x 6006524  
 3x 6096215  
 1x 6002849  
 1x 6002851

1x 6028018  
 1x 6028022  
 4x 6038637  
 4x 6096108  
 1x 6035326  
 2x 6030845  
 1x 4626884  
 1x 6097582  
 1x 6096286  
 4x 4211242  
 2x 4211180  
 4x 4211200

8x 4211210  
 20x 4211220  
 3x 4211181  
 2x 4216615  
 2x 4215496  
 10x 4529242  
 1x 6036503  
 1x 6034334  
 2x 6096217  
 4x 4267994  
 4x 4504376  
 4x 6075287  
 4x 4211199  
 2x 4211202  
 5x 4211221

1x 4216625  
 2x 6069984  
 1x 4658005  
 4x 6044725  
 2x 4655611  
 1x 4221744  
 4x 4224243  
 4x 4216695  
 9x 4211190  
 2x 4579690  
 2x 4243838  
 1x 4211214  
 2x 6055145  
 1x 6075213

1x 4211159  
 1x 4561915  
 1x 4541875  
 1x 4211163  
 1x 4533101  
 1x 4211185  
 1x 4262974  
 1x 6103876  
 1x 4622483  
 1x 6099520  
 1x 4626196  
 2x 4609635  
 2x 4536847

1x 4211311  
 1x 4598713  
 3x 6087062  
 1x 4548857  
 2x 6092409

1x 6085209  
 3x 6085211  
 1x 6085210

3x  
6061702

2x  
4533772

2x  
4211436

5x  
4211398

3x  
4211350

5x  
4565393

2x  
4211356

1x  
4211395

1x  
4560183

1x  
4211357

1x  
4556157

1x  
4211444

4x  
4650260

1x  
4211515

2x  
4211473

1x  
4512743

1x  
6051333

2x  
4211483

1x  
4211552

2x  
4211758

4x  
4509886

5x  
4211088

1x  
4210935

8x  
4234534

1x  
4211127

6x  
4211052

4x  
4211055

1x  
4210763

2x  
4581225

1x  
4210884

1x  
6086709

1x  
6055313

1x  
6055312

1x  
4217675

3x  
4210789

1x  
6100270

1x  
6044722

2x  
4289542

1x  
4210695

1x  
6051334

2x  
4211066

3x  
4600437

2x  
4516456

14x  
4210658

3x  
6015356

11x  
6060800

1x  
4529247

6x  
4587002

33x  
4523159

1x  
4541895

8x  
4541873

1x  
4538126

2x  
4540700

1x  
4286597





1x  
6058117

3x  
4638950

1x  
6102656

2x  
6102663

2x  
6102667

  
**Customer Service**  
**Kundenservice**  
**Service Consommateurs**  
**Servicio Al Consumidor**  
**LEGO.com/service or dial**  
  
**00800 5346 5555 :**   
**1-800-422-5346 :** 



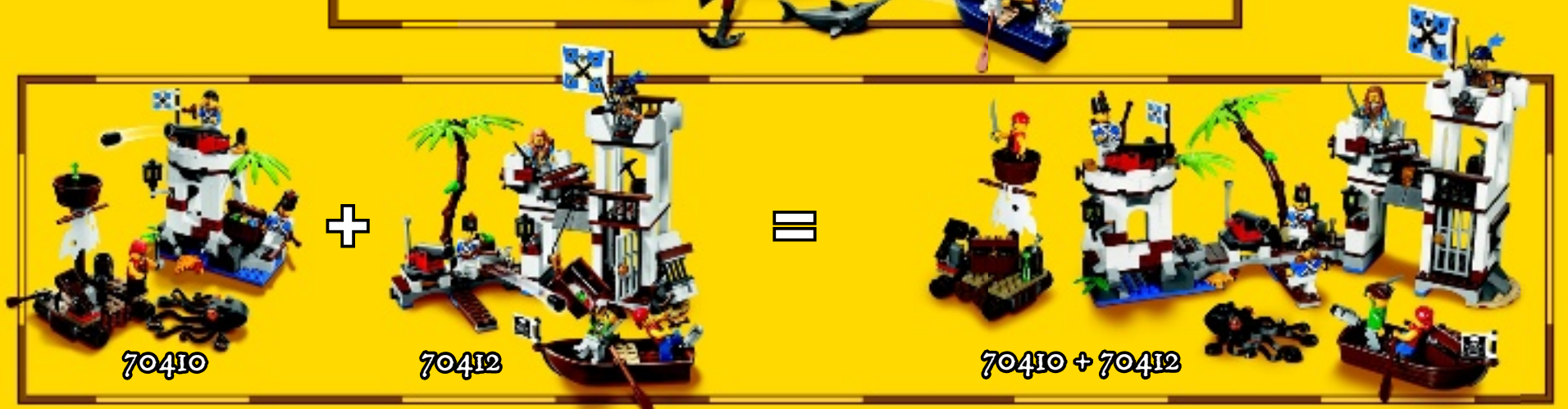
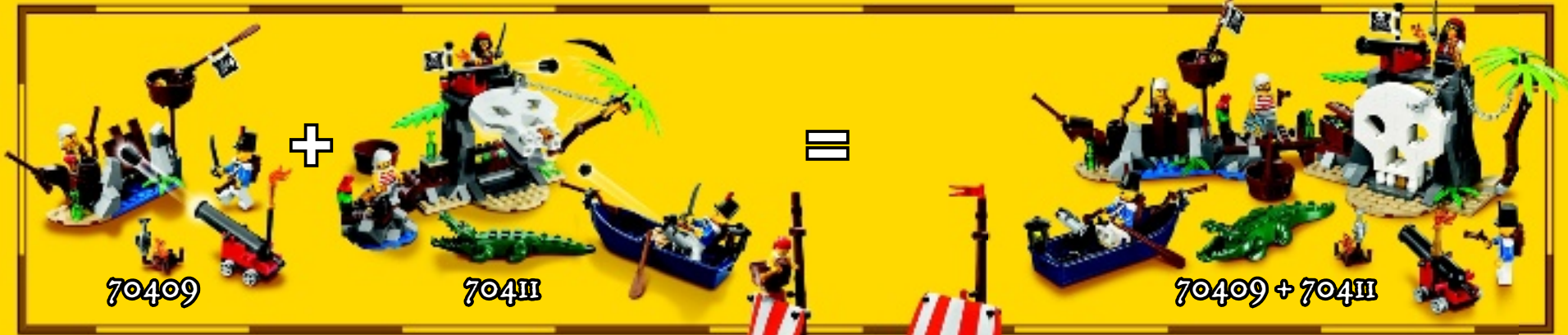

The LEGO logo is displayed in its classic white font with a yellow outline, set against a red square background.

# minifigures ONLINE



[playminifigures.com](http://playminifigures.com)



# club™

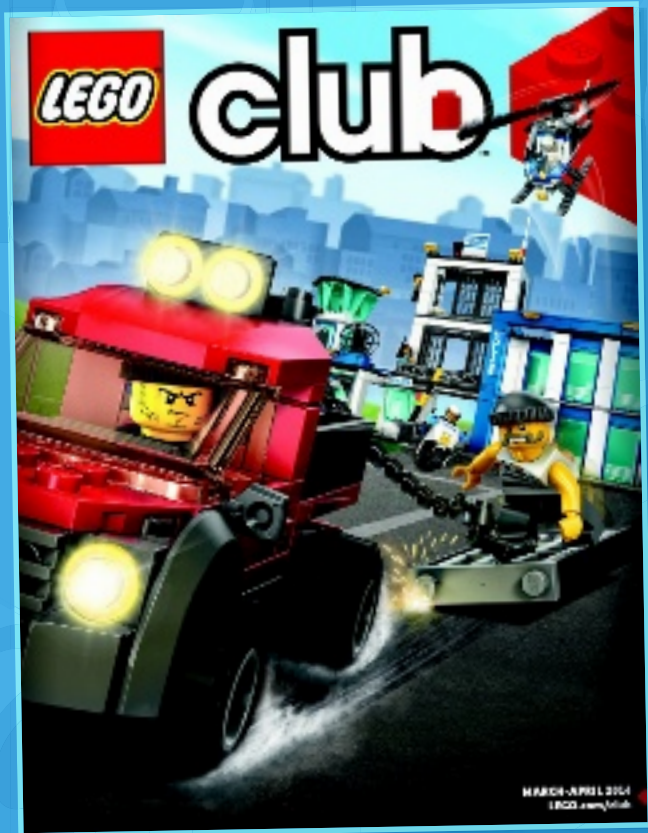

2



3



# WIN

GO TO [WWW.LEGO.COM/PRODUCTFEEDBACK](http://WWW.LEGO.COM/PRODUCTFEEDBACK) AND  
GIVE US YOUR SHORT **FEEDBACK** ABOUT THIS  
LEGO® SET FOR A CHANCE TO WIN  
A COOL LEGO PRIZE.



## LEGO.com/productfeedback

### GEWINNE



Erzähle uns auf  
[www.LEGO.com/productfeedback](http://www.LEGO.com/productfeedback)

etwas über die Erfahrungen, die  
du mit diesem LEGO® Set gemacht  
hast, und sichere dir die Chance  
auf einen coolen LEGO Preis!

### GAGNE



Rends-toi sur  
[www.LEGO.com/productfeedback](http://www.LEGO.com/productfeedback)

et donne-nous quelques com-  
mentaires sur ce produit LEGO®  
pour avoir une chance de gagner  
un prix LEGO !

### GANAN



Visita  
[www.LEGO.com/productfeedback](http://www.LEGO.com/productfeedback)

y envíanos tu opinión acerca de  
este set LEGO®. ¡Participarás en el  
sorteo de un premio LEGO!

### 获取奖品



登录  
[www.LEGO.com/productfeedback](http://www.LEGO.com/productfeedback)

给出关于此乐高®套装的简短反馈，  
就有机会获得炫酷乐高奖品

### 경품 당첨 기회



[www.LEGO.com/productfeedback](http://www.LEGO.com/productfeedback)

페이지로 이동하여 이 레고® 세트에  
대한 간략한 피드백을 보내 주시고  
멋진 레고 경품을 탈 수 있는 기회도  
잡으십시오

### ЗАПОЛНИ АНКЕТУ И ПОЛУЧИ ПРИЗ



Перейди по ссылке  
[www.LEGO.com/productfeedback](http://www.LEGO.com/productfeedback)

ответь всего на несколько во-  
просов об этом наборе LEGO®,  
и у тебя появится шанс выиграть  
замечательный приз от компании  
LEGO.