



# SCOOBY-DOO!

75904



 [LEGO.com/scoobydoo](https://www.LEGO.com/scoobydoo)





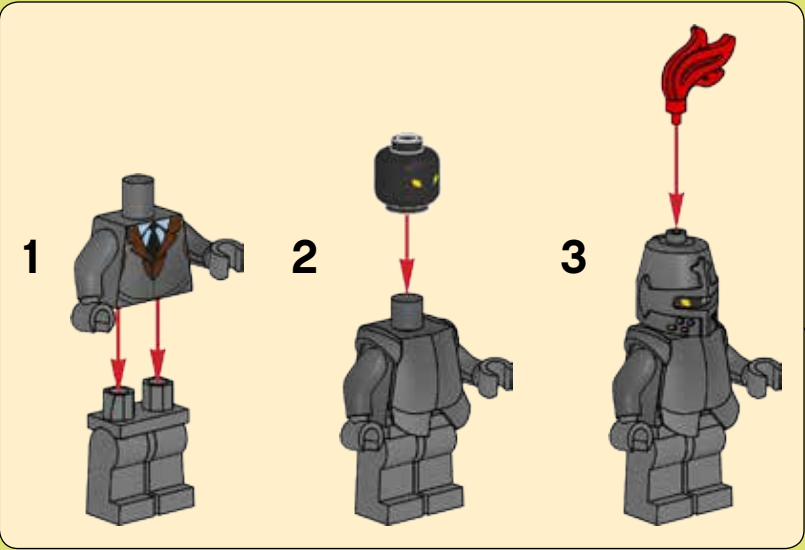
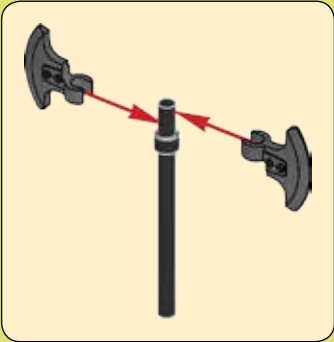
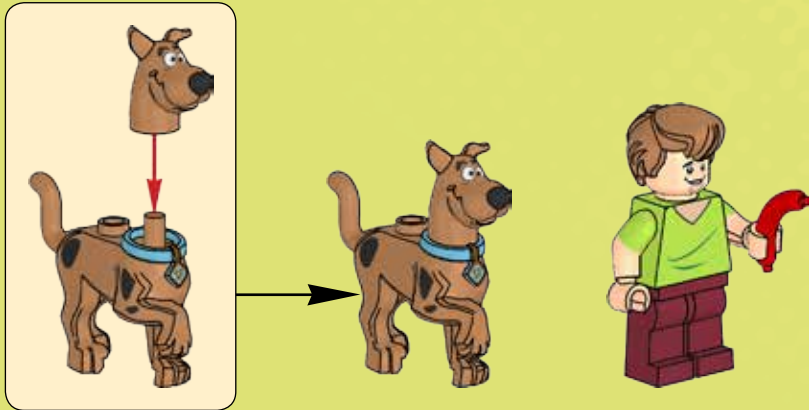

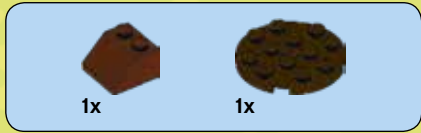

1

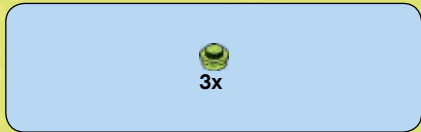

2



3







4



5

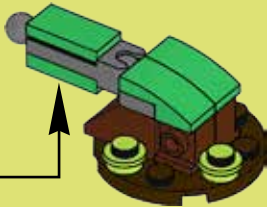
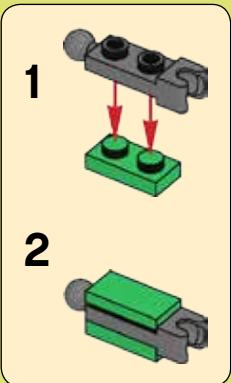

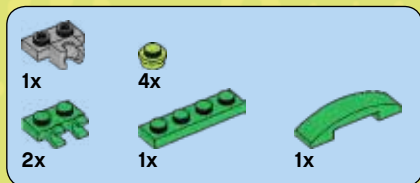

6

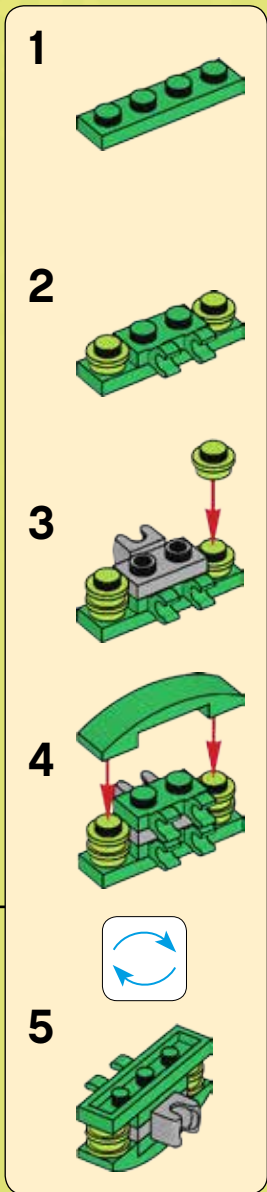
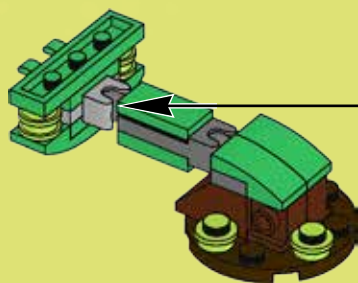

7





8

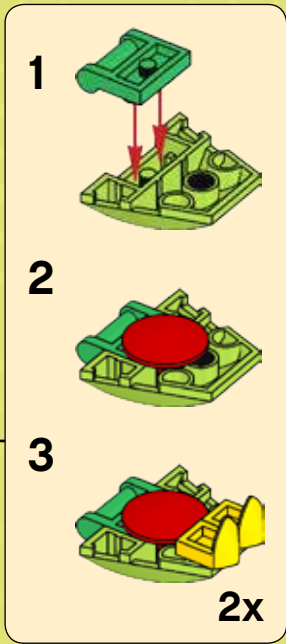
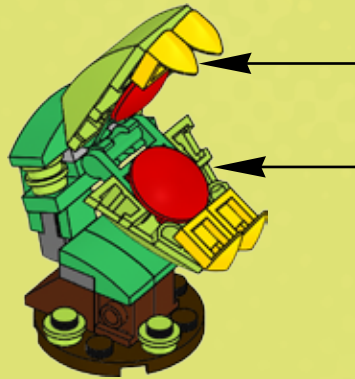

9





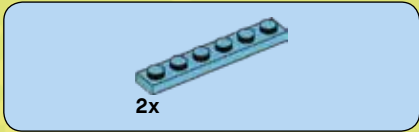

1

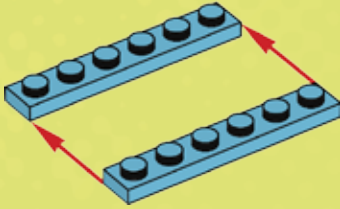

2

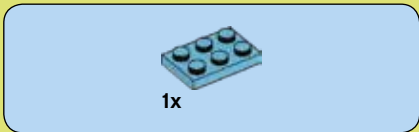
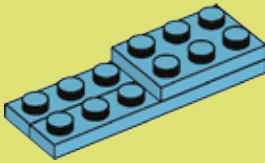

3

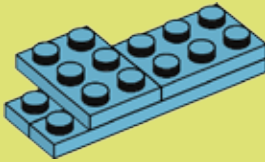

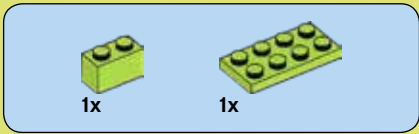

4

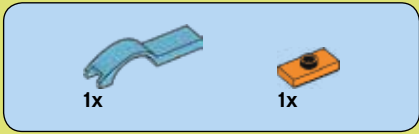
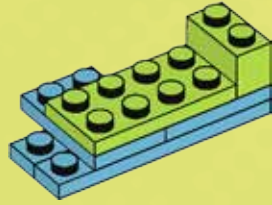

5

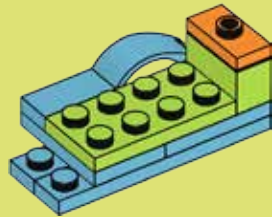

6

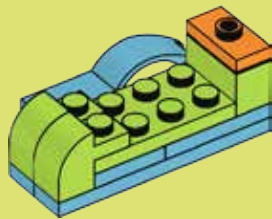

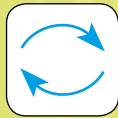

7

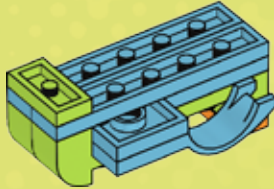

8

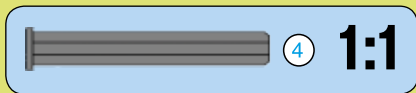
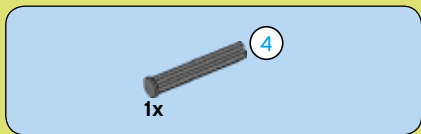
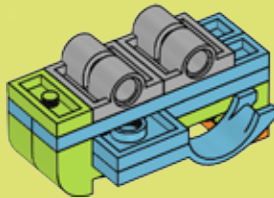

9

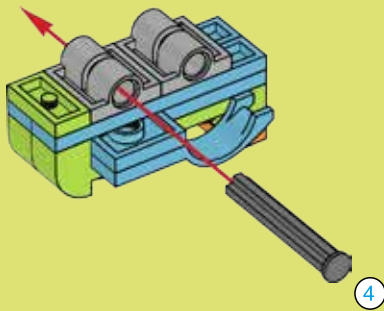



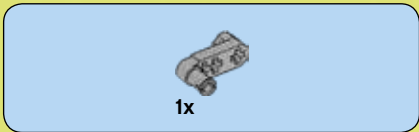

# 10

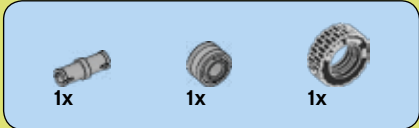
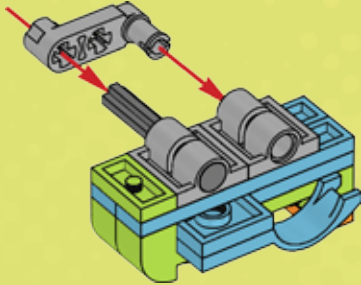

# 11

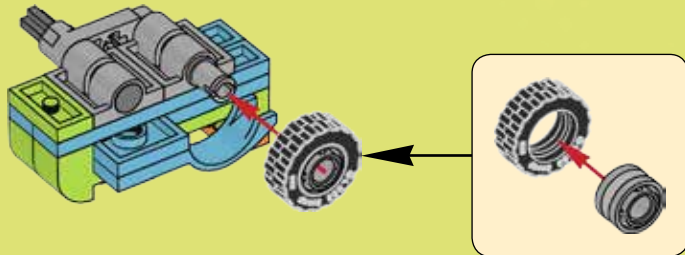

# 12

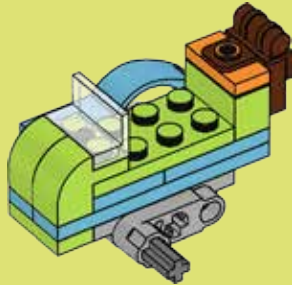

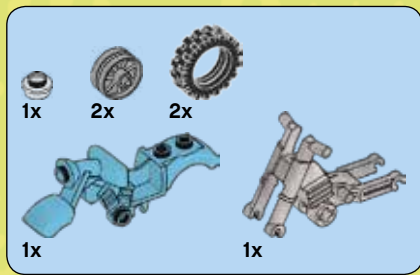

# 13

1



2

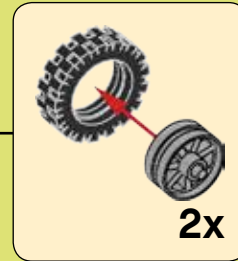
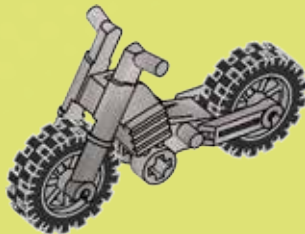

3

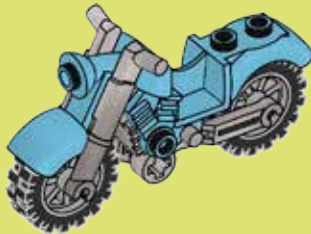

4

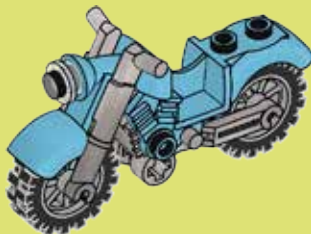

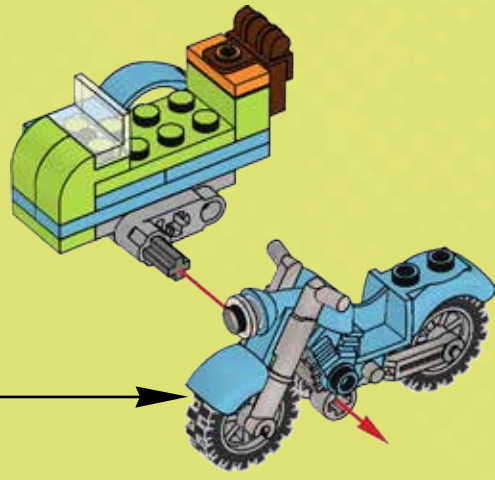

14





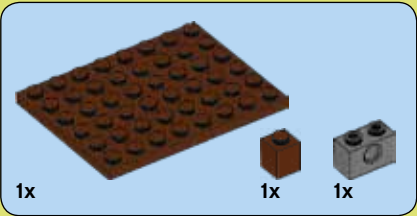
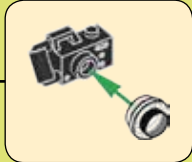
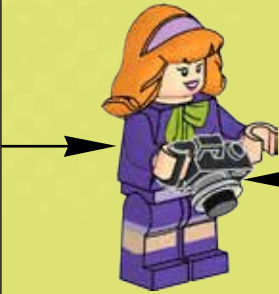
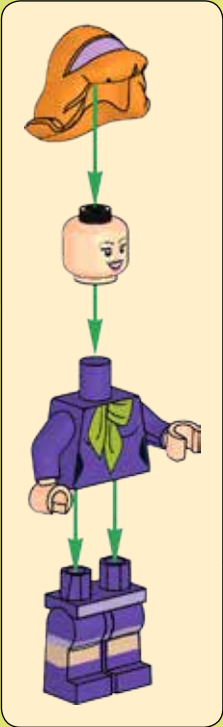
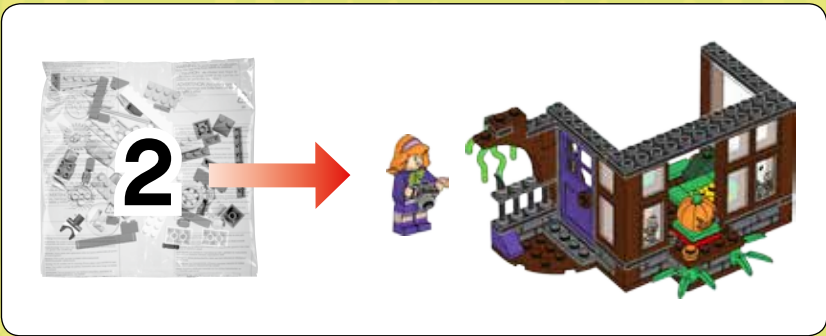

1

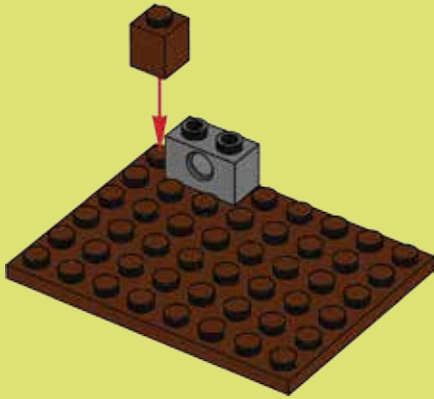



2

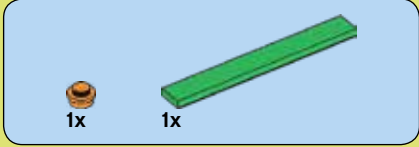

3

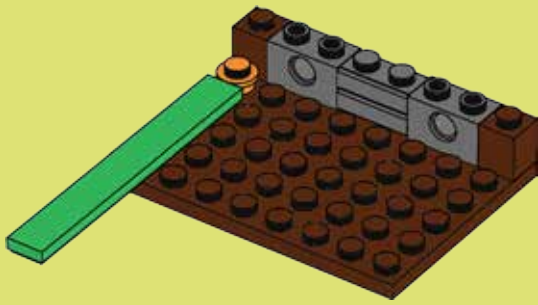

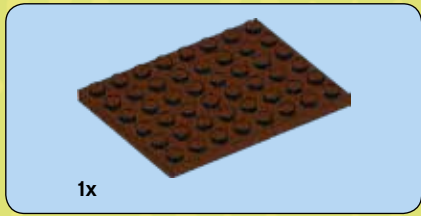

4

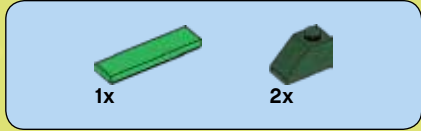

5

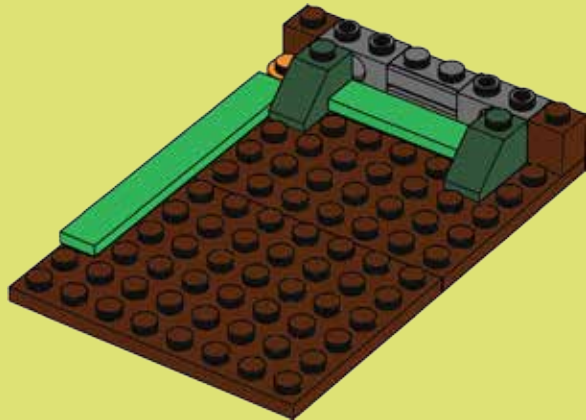

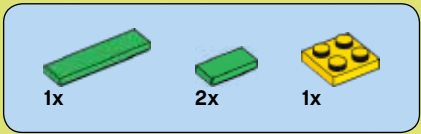

6



7

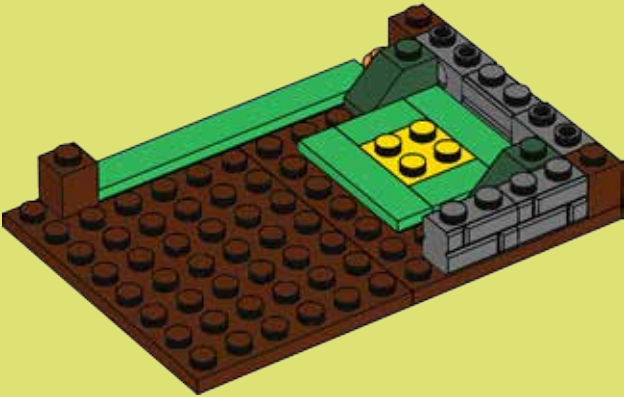

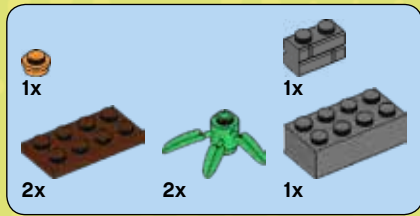

# 8

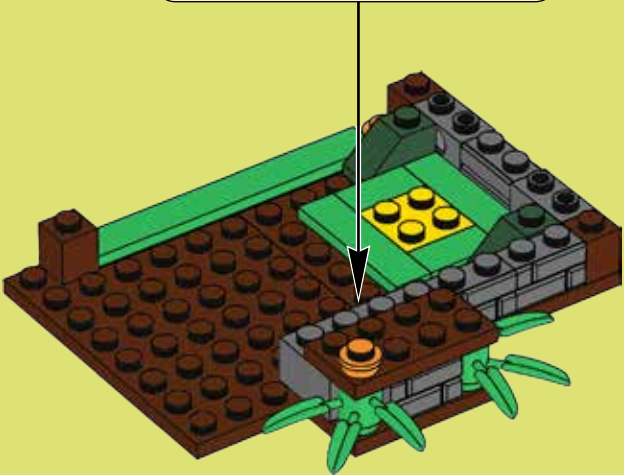
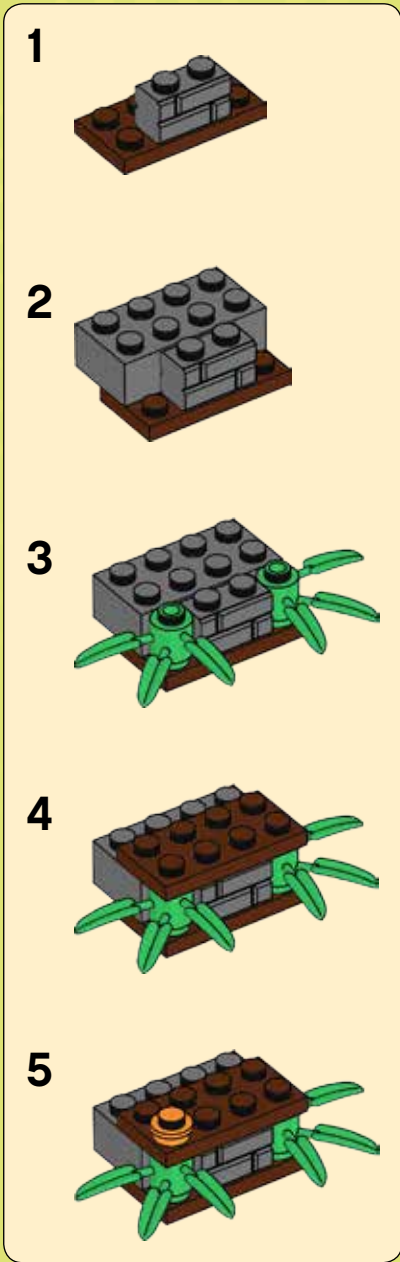





1x



2x

# 9

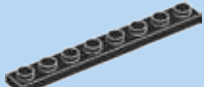

2x



1x

# 10



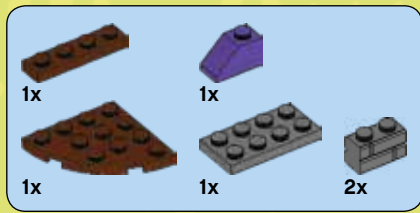

# 11

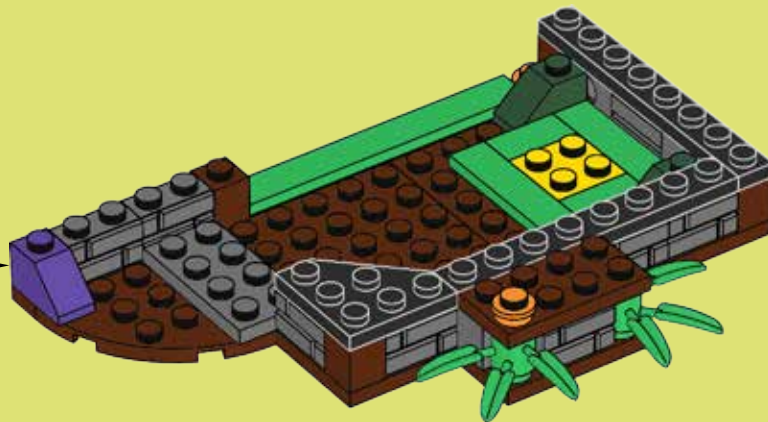
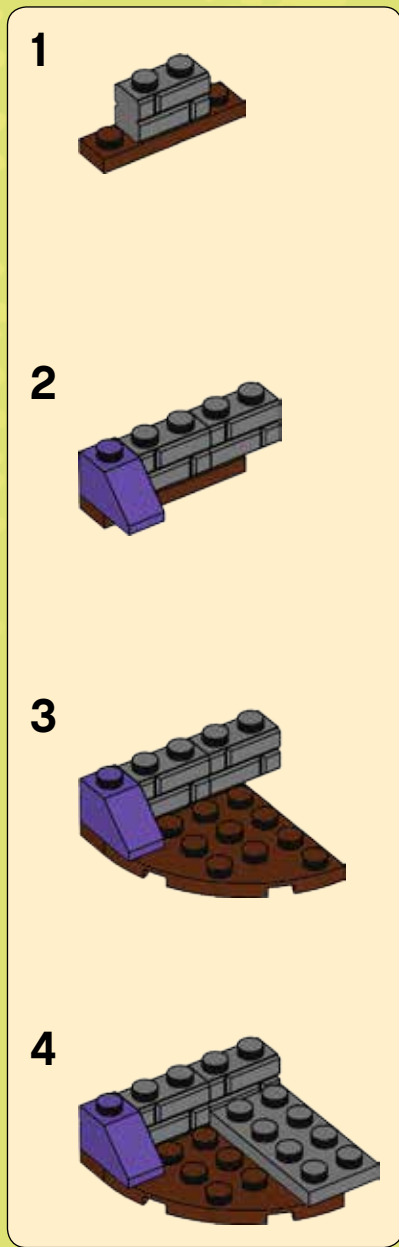

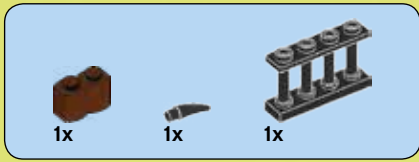

# 12

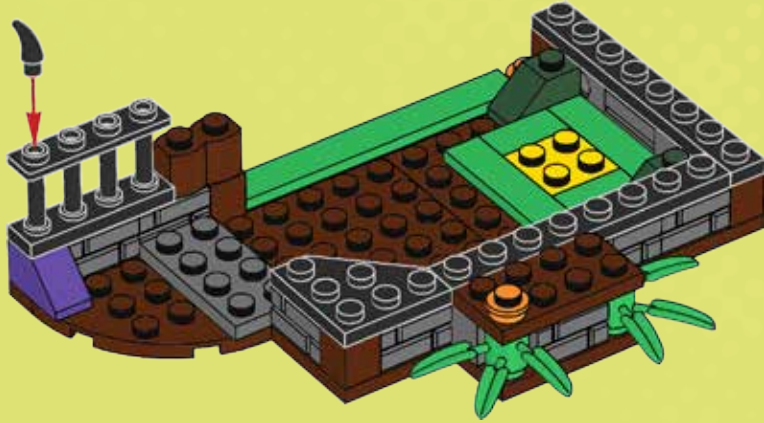

# 13





14

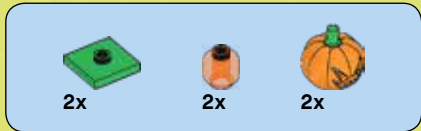
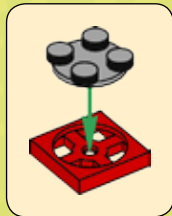

15

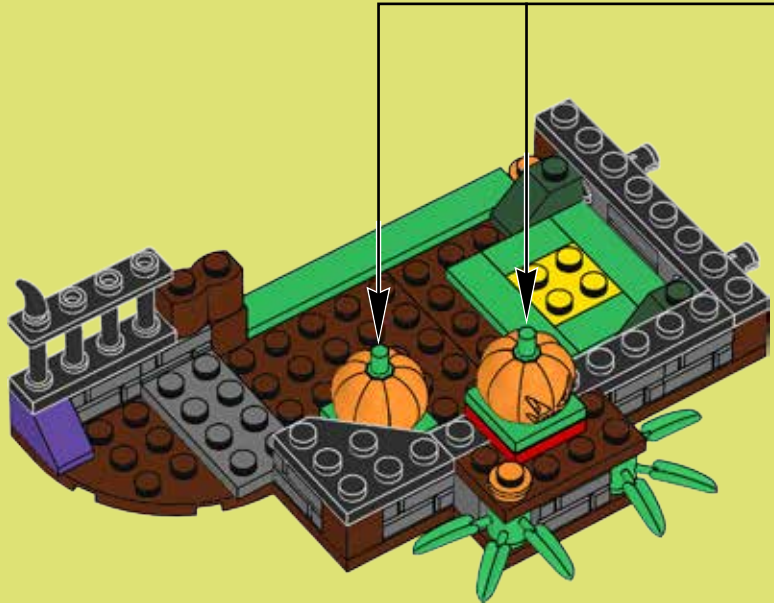





1x



1x

# 16



1x



1x

# 17

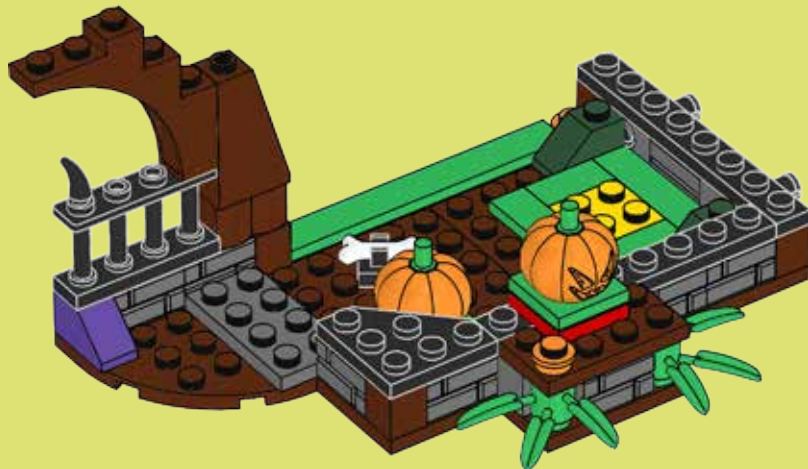





# 18

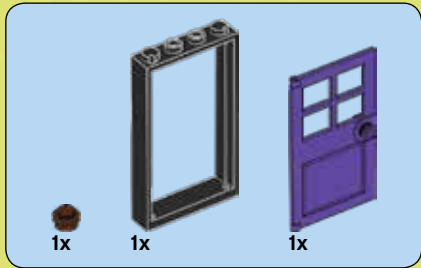
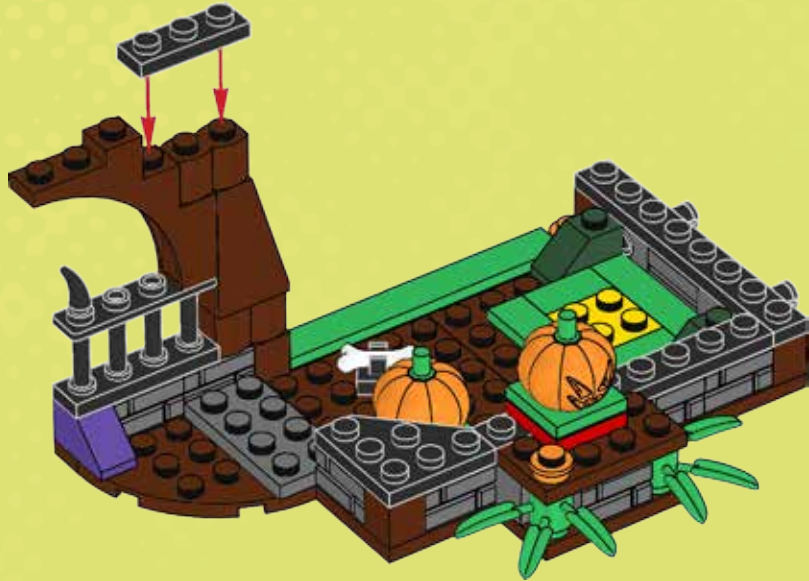

# 19

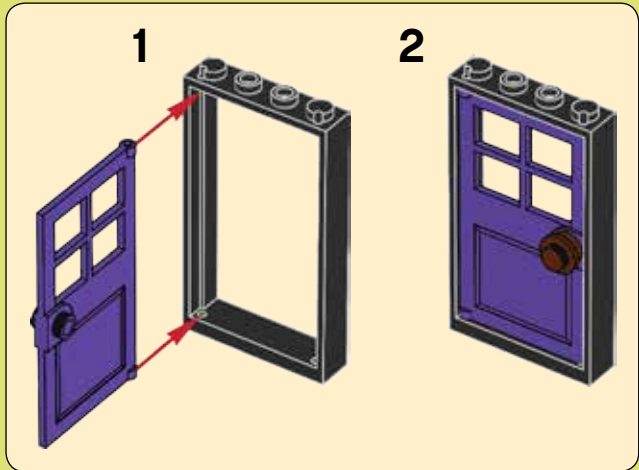

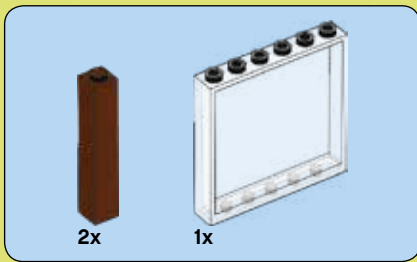

20

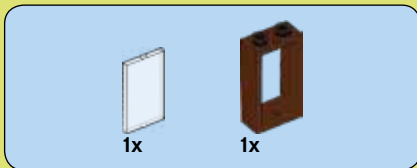

21

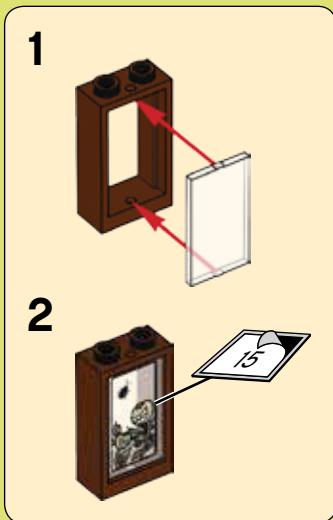



22

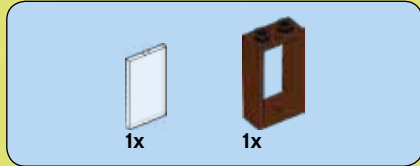
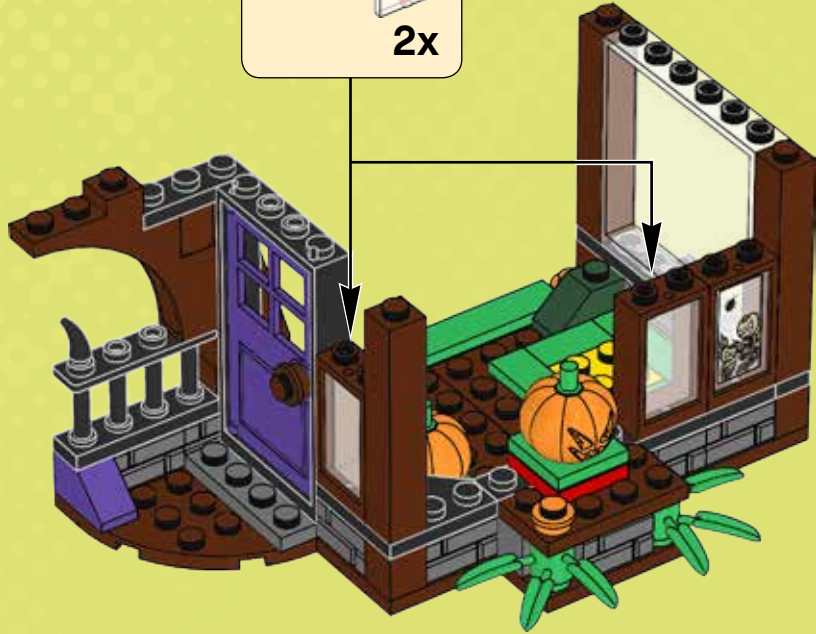
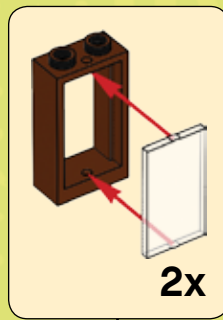

23

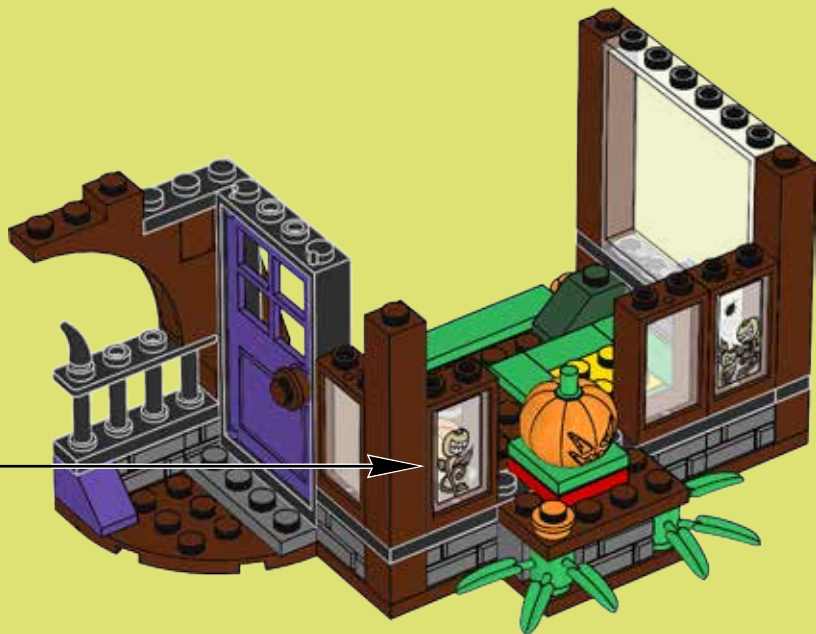
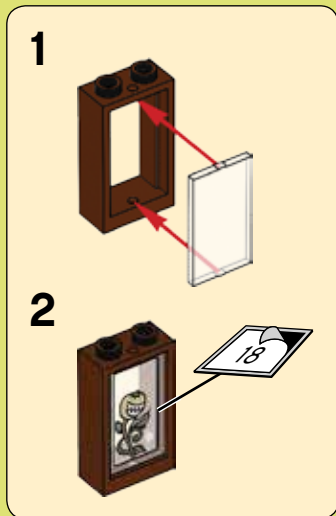



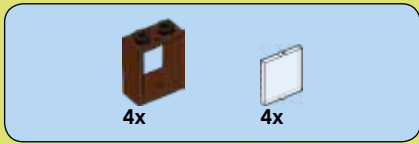

24

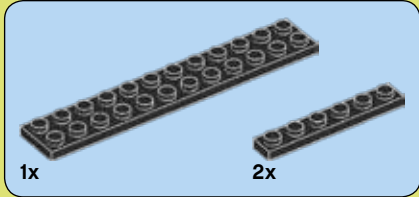
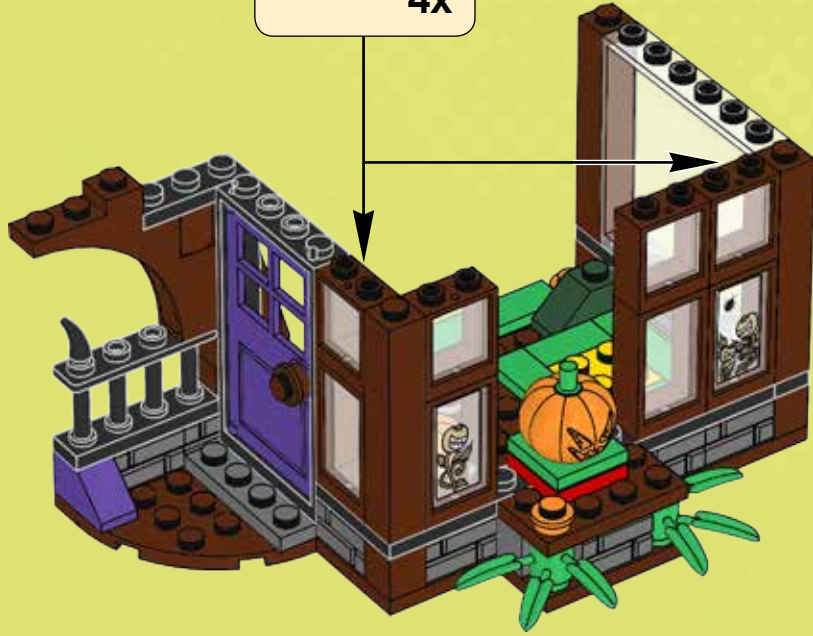
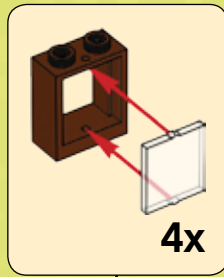

25





1x



1x

# 26



1x

# 27

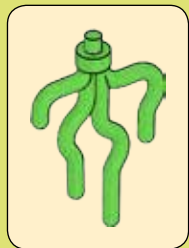



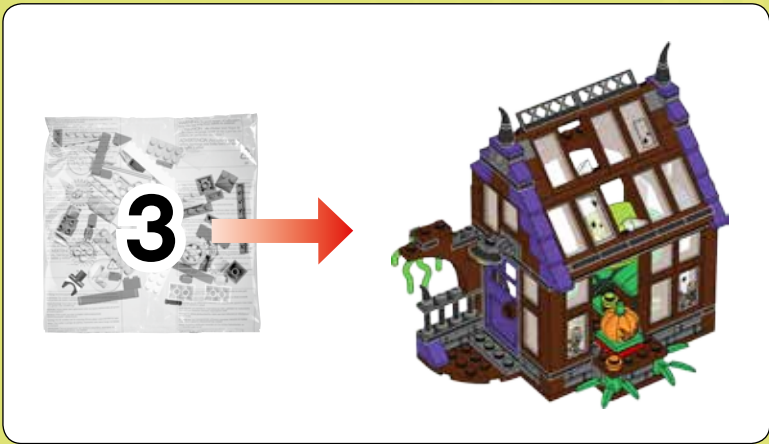

28





2x

# 29



1x



1x



2x

# 30

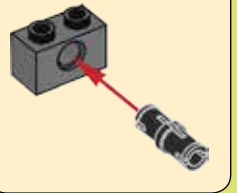
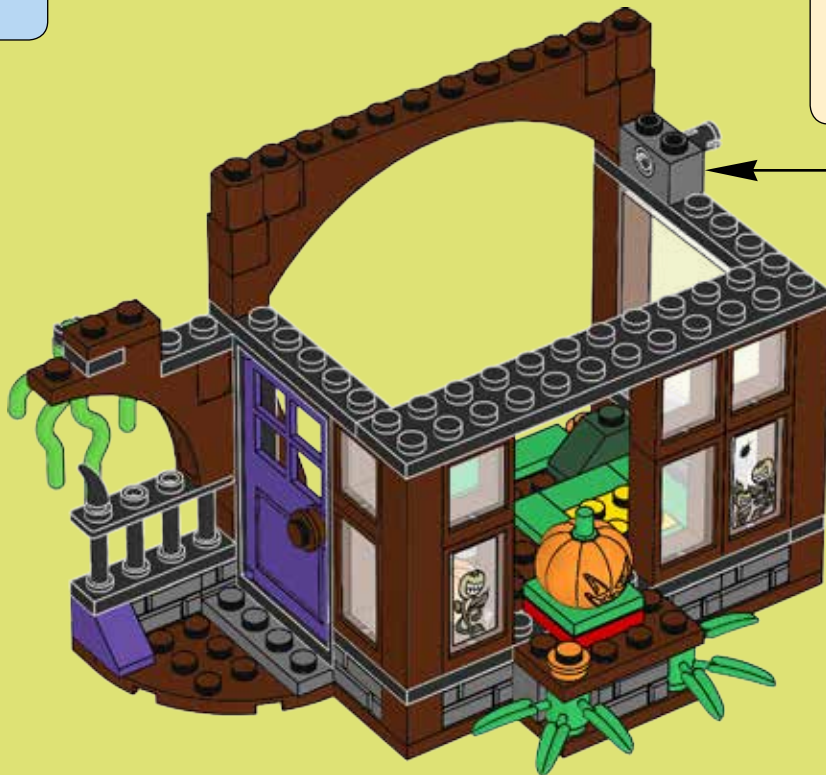

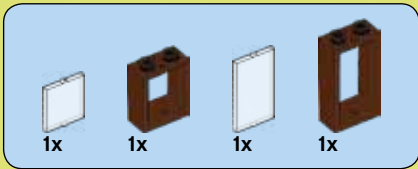

# 31

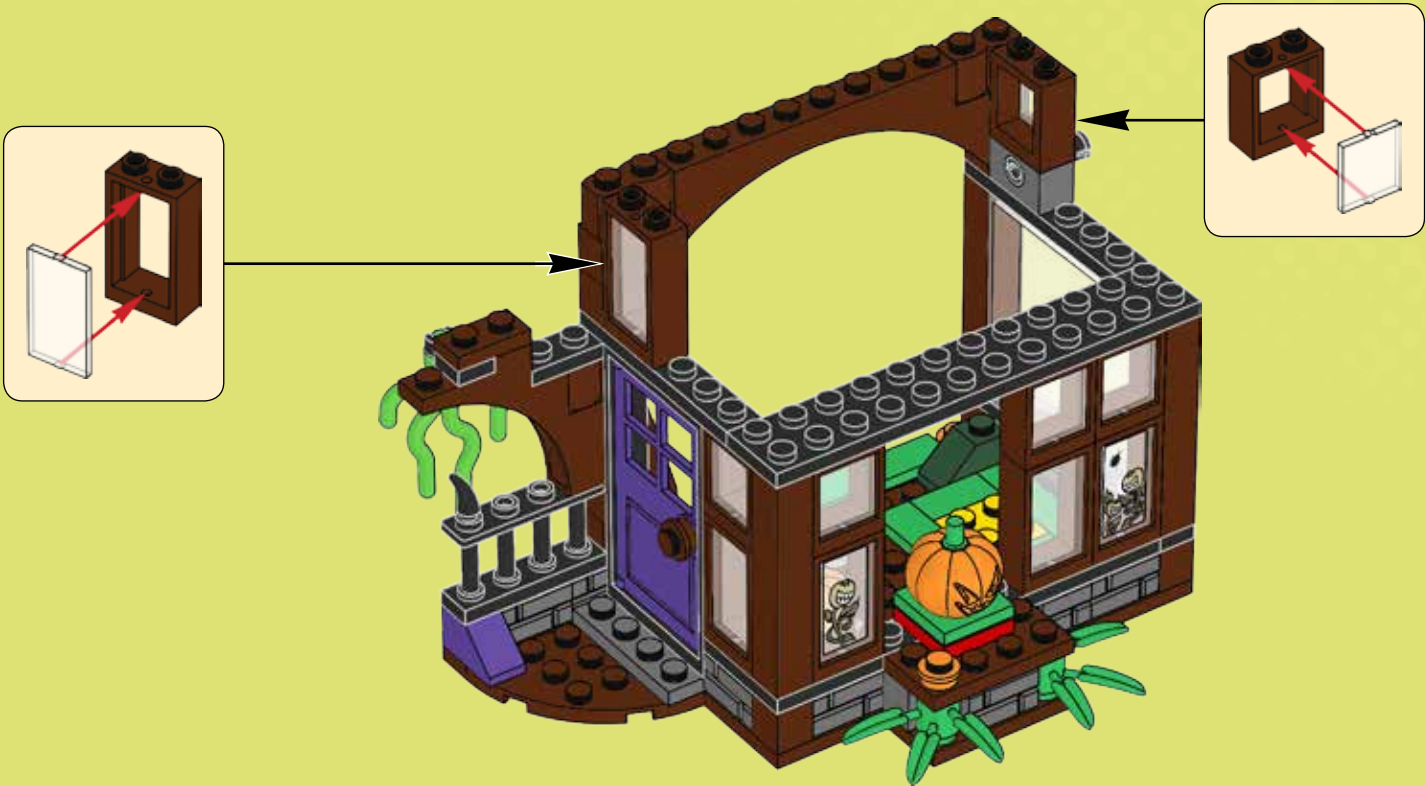





1x

# 32



1x



1x



1x



1x

# 33

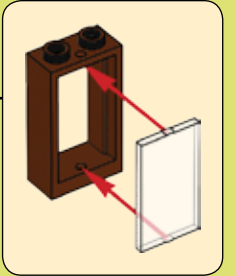
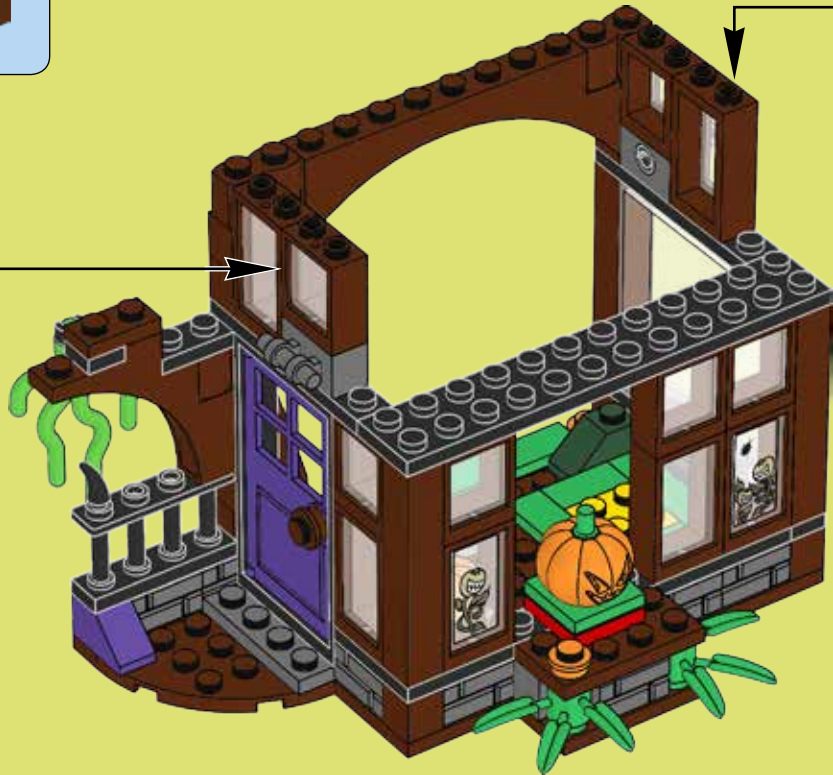
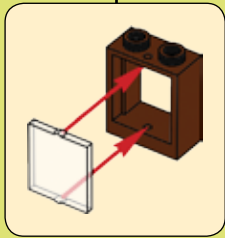



1x



1x



2x

# 34



2x



2x

# 35







2x

# 36



2x



4x

# 37

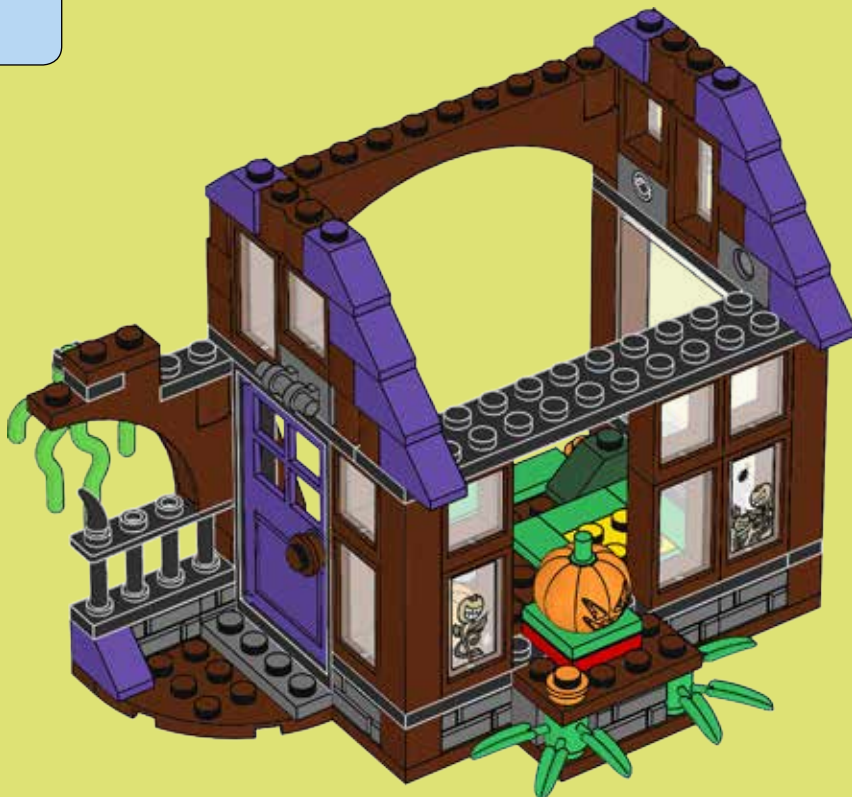



2x

38



1x

39

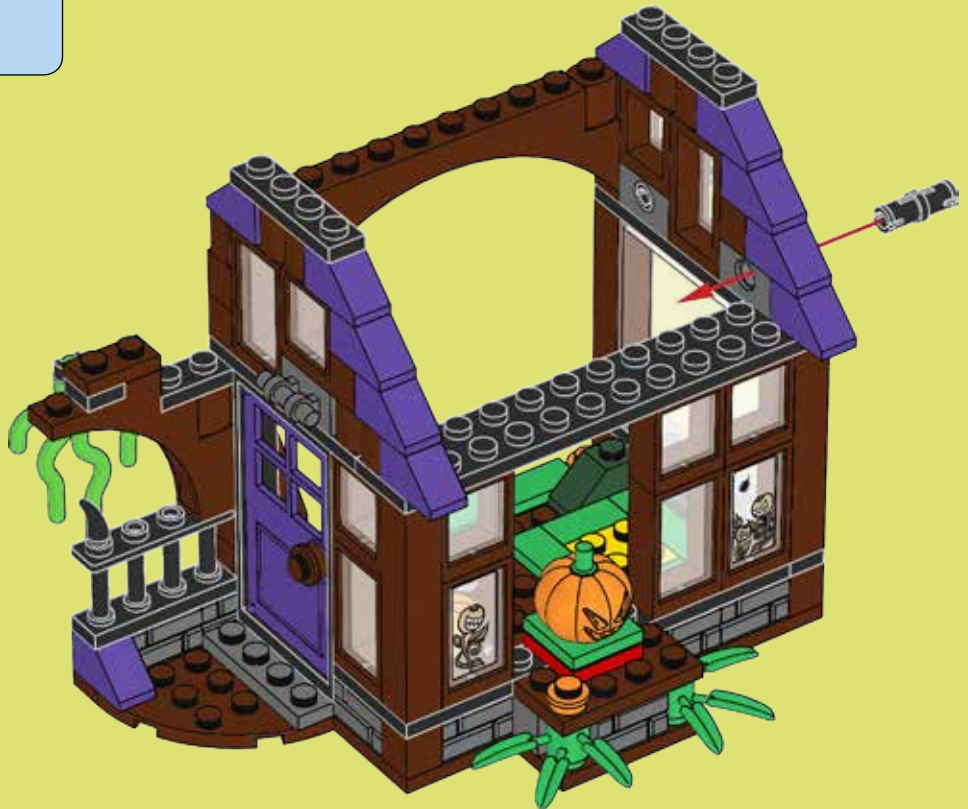



- 1x 
- 1x 
- 1x 

# 40

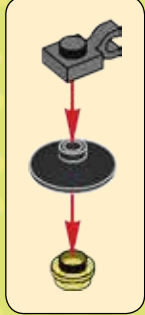

- 2x 

# 41



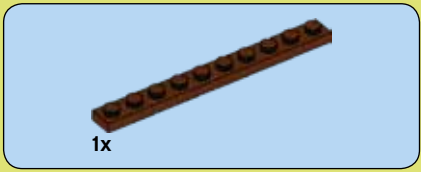
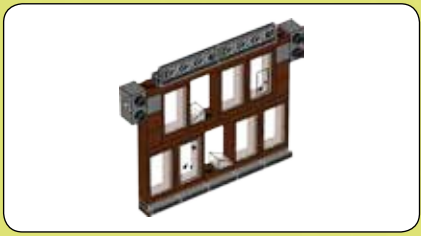

**1**



**2**

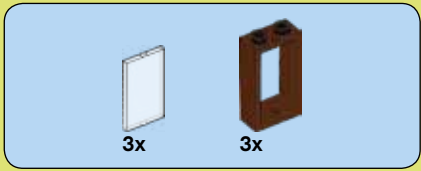
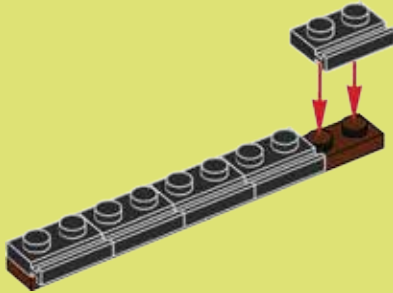

**3**

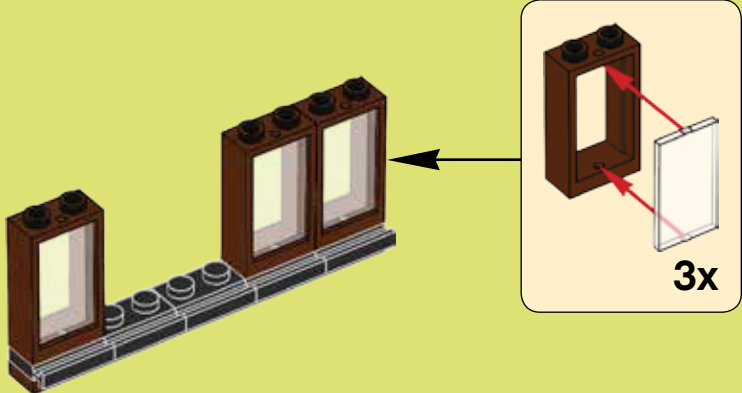



4

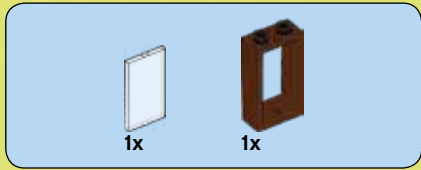
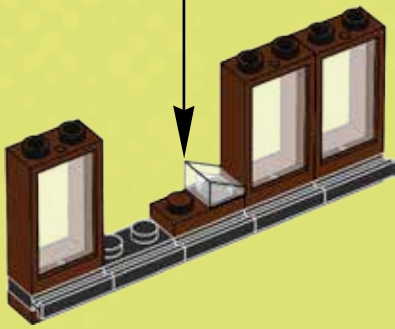

5

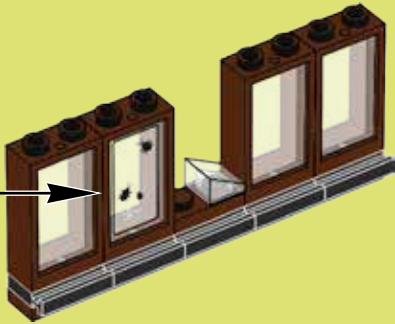
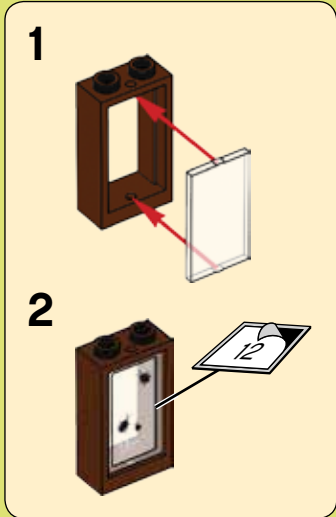





6

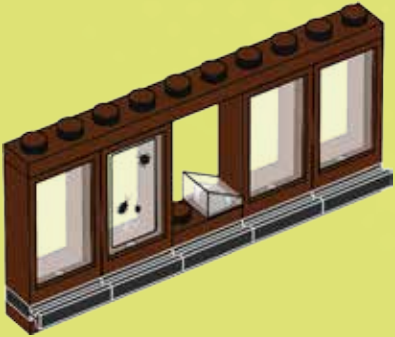

7

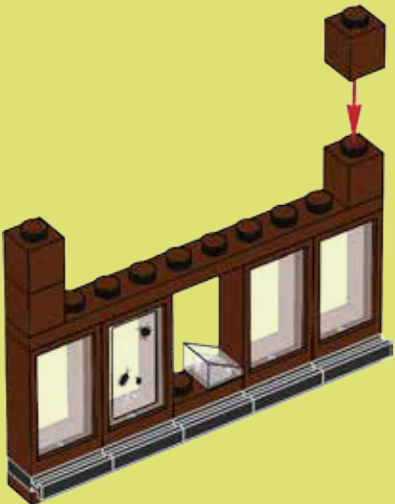

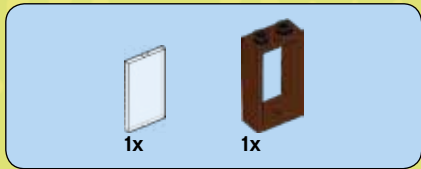

8

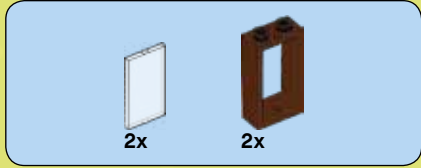
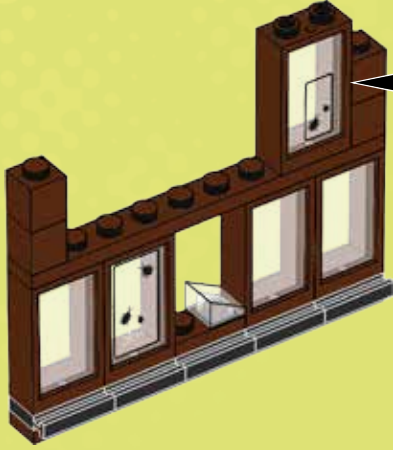
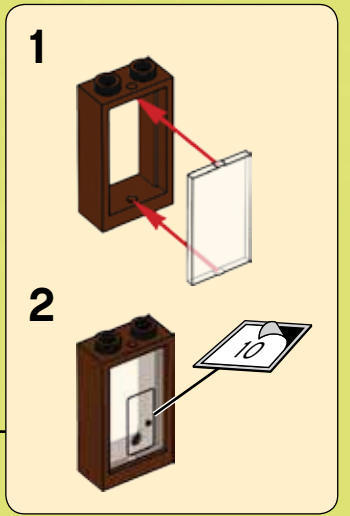

9

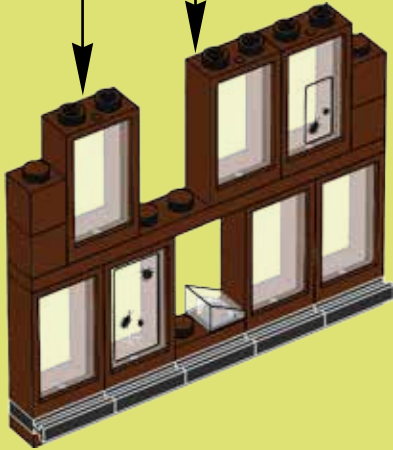
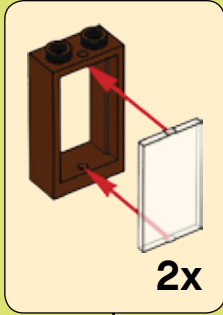



10

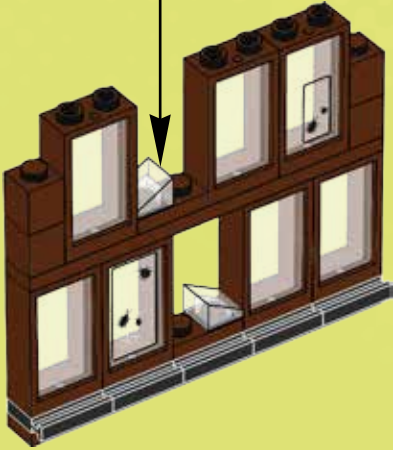

11

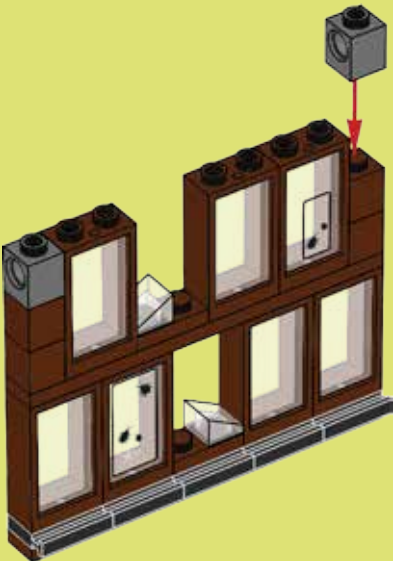



12

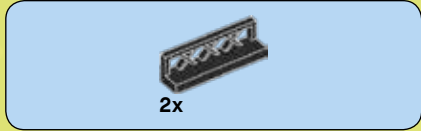
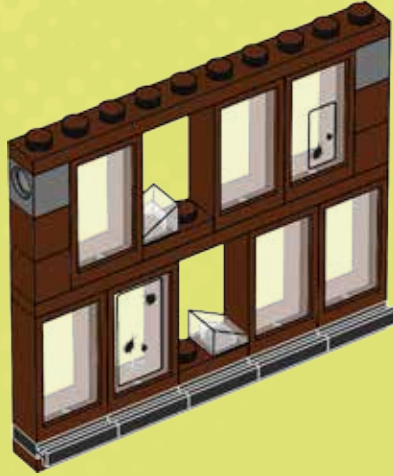

13

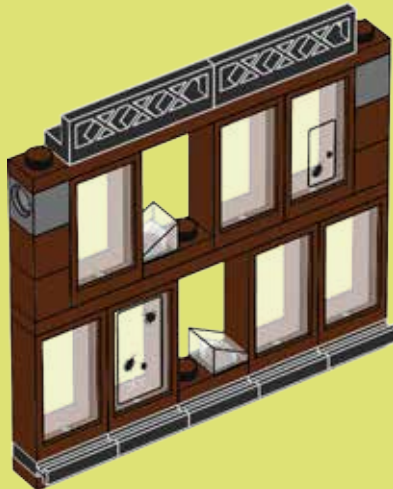





2x

# 14

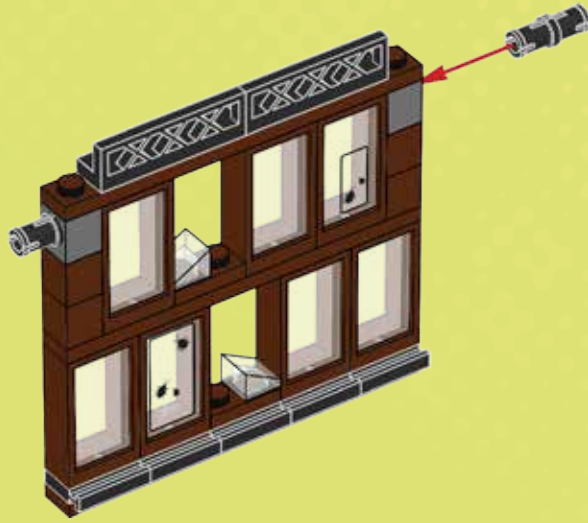

2x

# 15

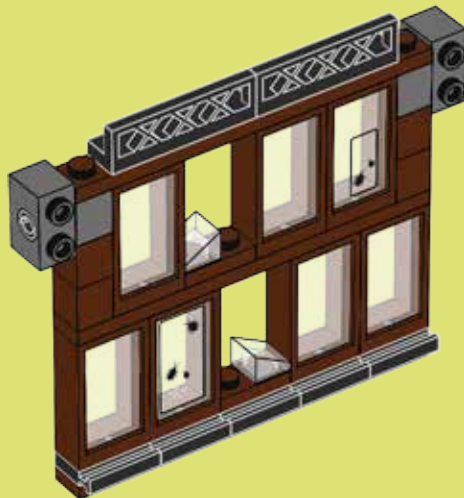

42





2x



2x

# 43



2x



2x

# 44



2x



45

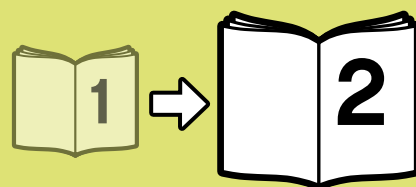
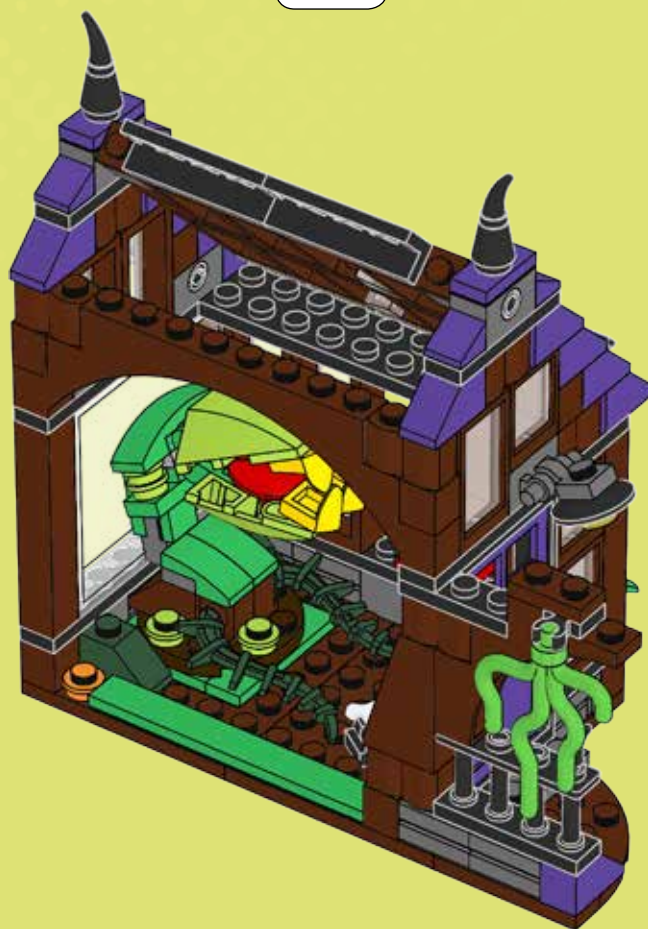
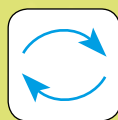





# SCOOBY-DOO!

WE'VE GOT A MYSTERY TO SOLVE  
WIR MÜSSEN EIN GEHEIMNIS LÜFTEN  
NOUS AVONS UN MYSTÈRE À RÉSOUDRE

TENEMOS UN MISTERIO QUE RESOLVER  
TEMOS UM MISTÉRIO PARA RESOLVER  
MÁIS VAN EGY MEGOLDÁSRA VÁRÓ REJTÉLYÜNK

75900



75901



75902



75903



75904



[LEGO.COM/scoobydoo](http://LEGO.COM/scoobydoo)





# WIN

GO TO [WWW.LEGO.COM/PRODUCTFEEDBACK](http://WWW.LEGO.COM/PRODUCTFEEDBACK)  
AND GIVE US YOUR SHORT **FEEDBACK**  
ABOUT THIS LEGO® SET FOR A CHANCE  
TO WIN A COOL LEGO PRIZE.



## LEGO.com/productfeedback



### GEWINNE

Erzähle uns auf  
[www.LEGO.com/productfeedback](http://www.LEGO.com/productfeedback)

etwas über die Erfahrungen, die du  
mit diesem LEGO® Set gemacht hast,  
und sichere dir die Chance auf einen  
coolen LEGO Preis!



### GAGNE

Rends-toi sur  
[www.LEGO.com/productfeedback](http://www.LEGO.com/productfeedback)

et donne-nous quelques commen-  
taires sur ce produit LEGO® pour avoir  
une chance de gagner un prix LEGO !



### GANAN

Visita  
[www.LEGO.com/productfeedback](http://www.LEGO.com/productfeedback)

y envíanos tu opinión acerca de este  
set LEGO®. ¡Participarás en el sorteo  
de un premio LEGO!



### 获取奖品

登录  
[www.LEGO.com/productfeedback](http://www.LEGO.com/productfeedback)

给出关于此乐高®套装的简短反馈，  
就有机会获得炫酷乐高奖品



### 경품 당첨 기회

[www.LEGO.com/productfeedback](http://www.LEGO.com/productfeedback)

페이지로 이동하여 이 레고® 세트에  
대한 간략한 피드백을 보내 주시고  
멋진 레고 경품을 탈 수 있는 기회도  
잡으십시오



### ЗАПОЛНИ АНКЕТУ И ПОЛУЧИ ПРИЗ

Перейди по ссылке  
[www.LEGO.com/productfeedback](http://www.LEGO.com/productfeedback)

ответь всего на несколько вопро-  
сов об этом наборе LEGO®, и у тебя  
появится шанс выиграть замеча-  
тельный приз от компании LEGO.







# SCOOBY-DOO!

75904



 [LEGO.com/scoobydoo](http://LEGO.com/scoobydoo)

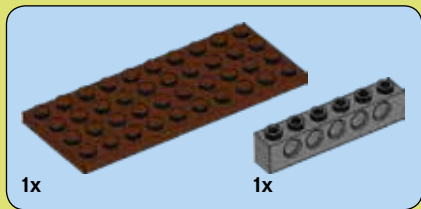
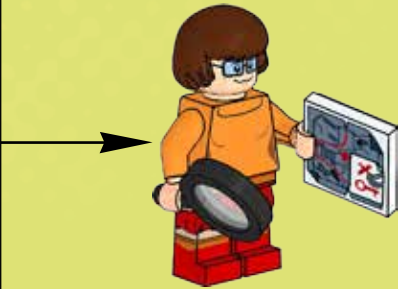
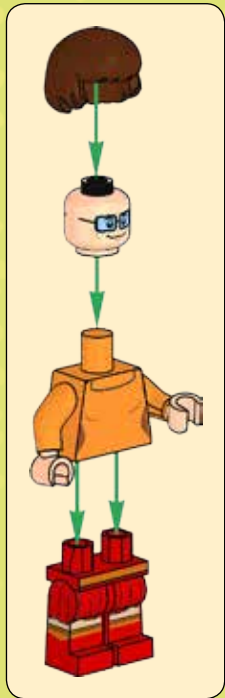
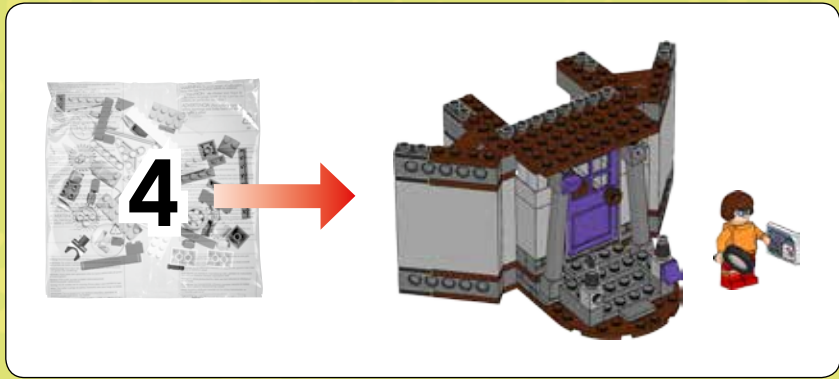

1





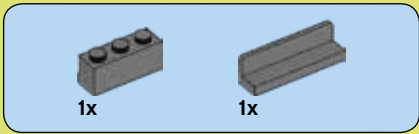

2

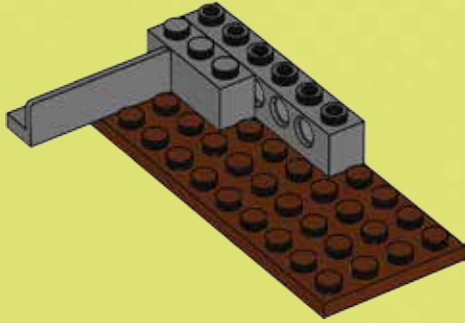

3

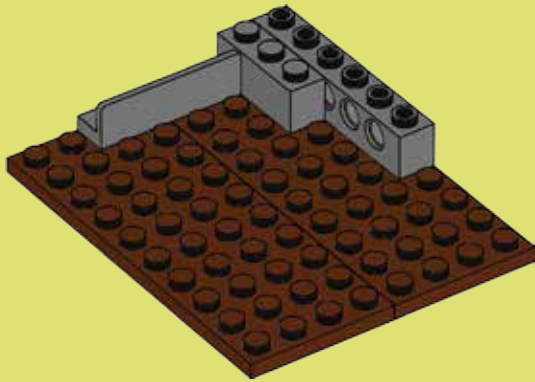

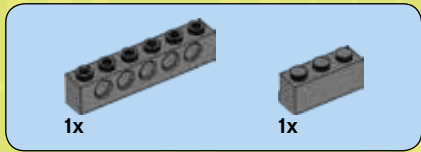

4

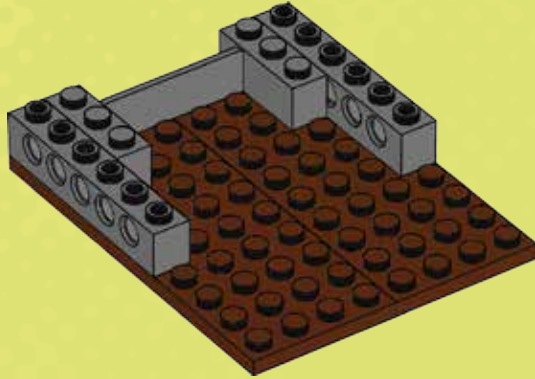

5

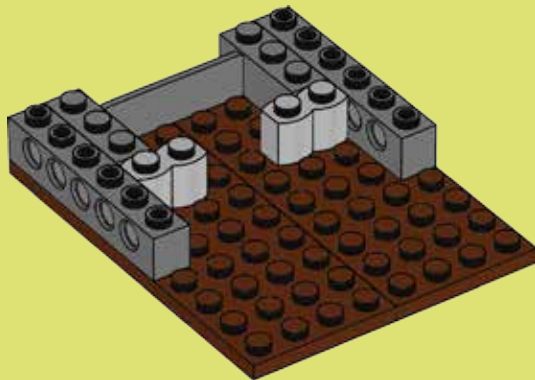

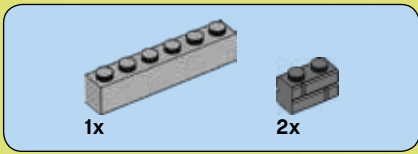

6

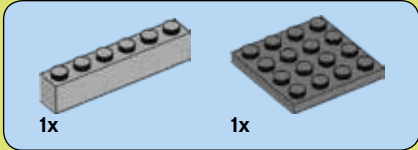
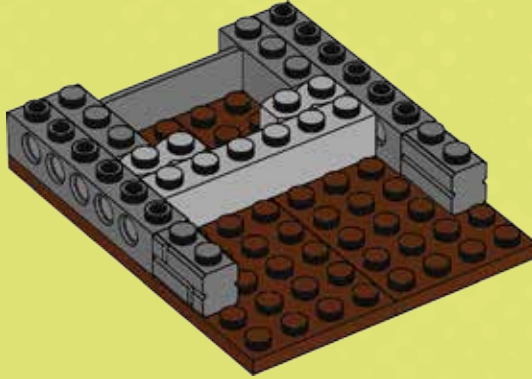

7

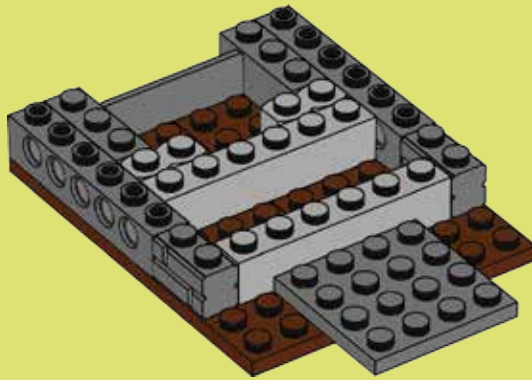



2x

8

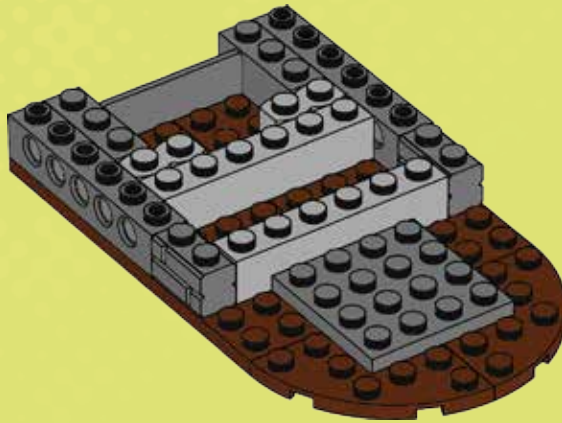

2x



1x



2x

9

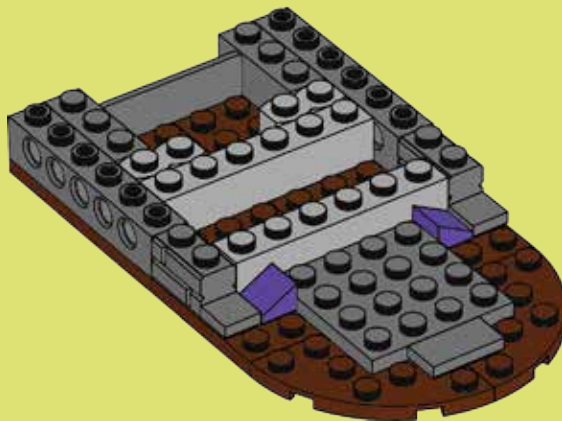



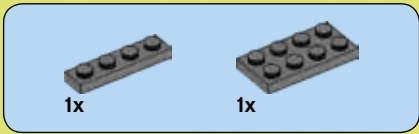

# 10

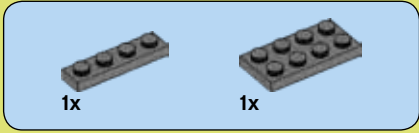
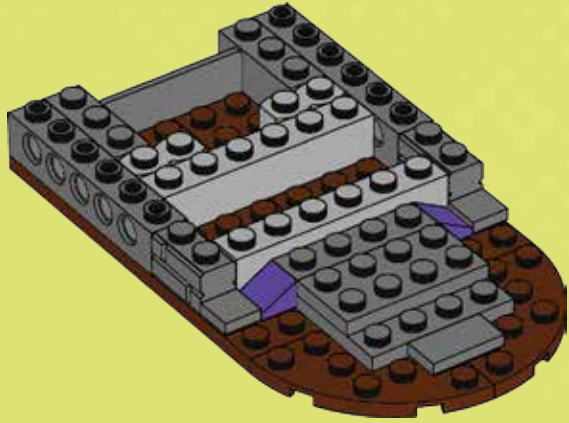

# 11

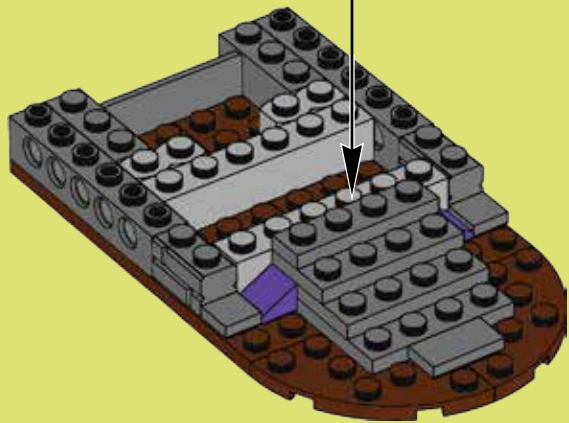
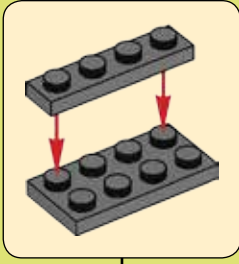



2x

# 12

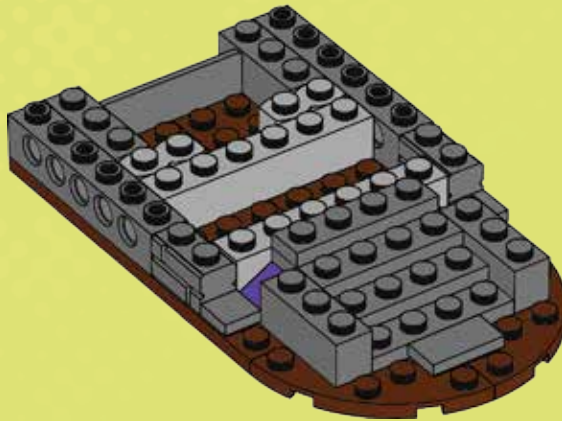

4x

# 13

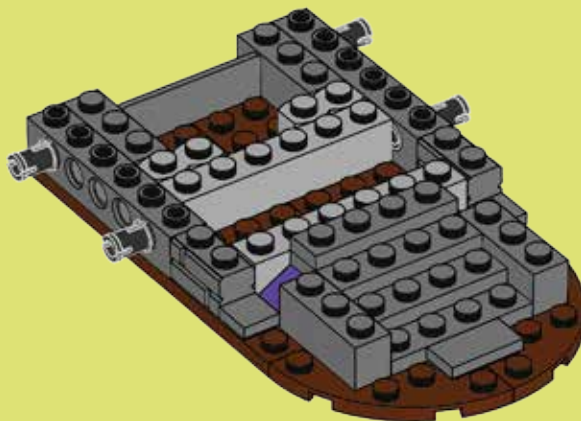

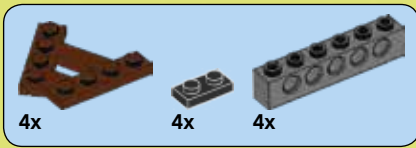

# 14

1

2

3

4

2x

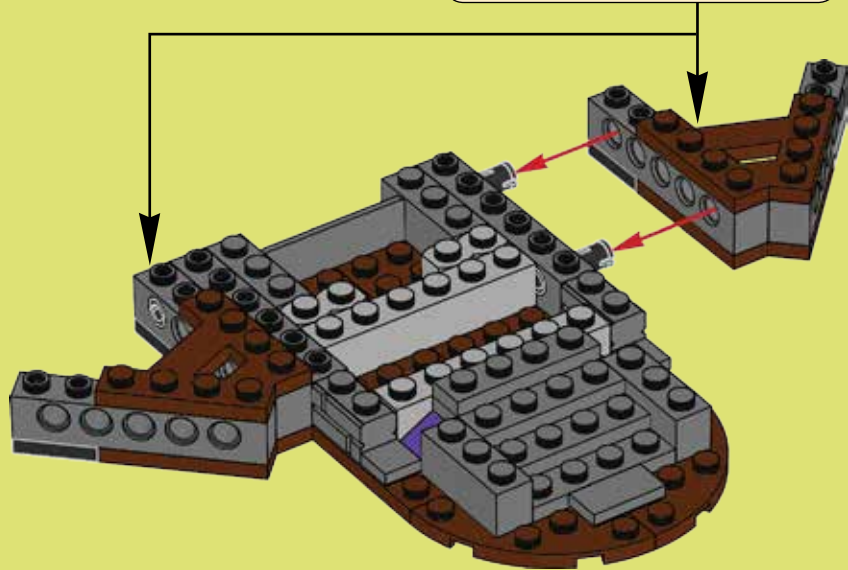

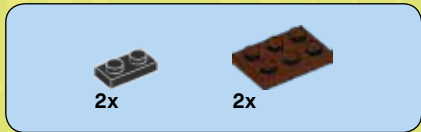

# 15

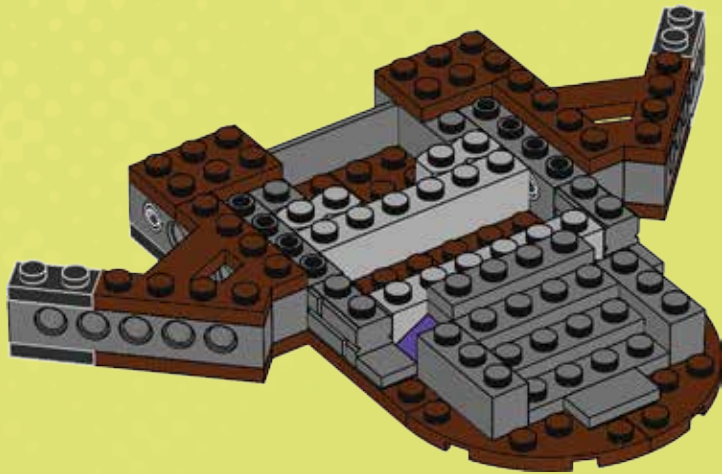

# 16







17

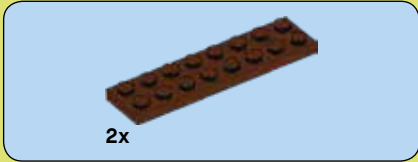
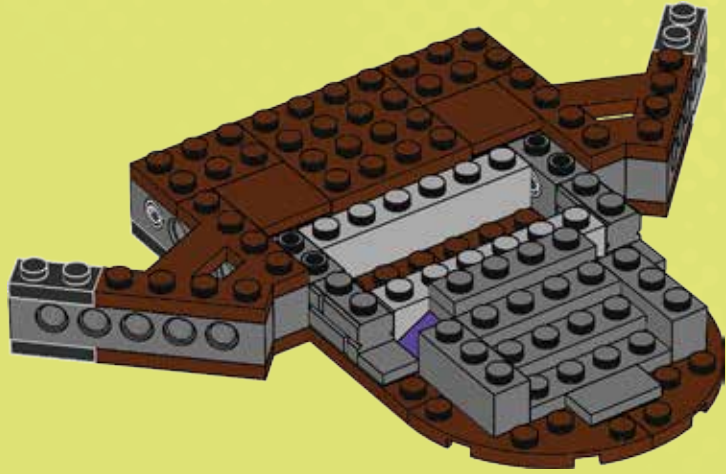

18





4x

# 19

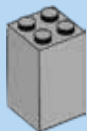
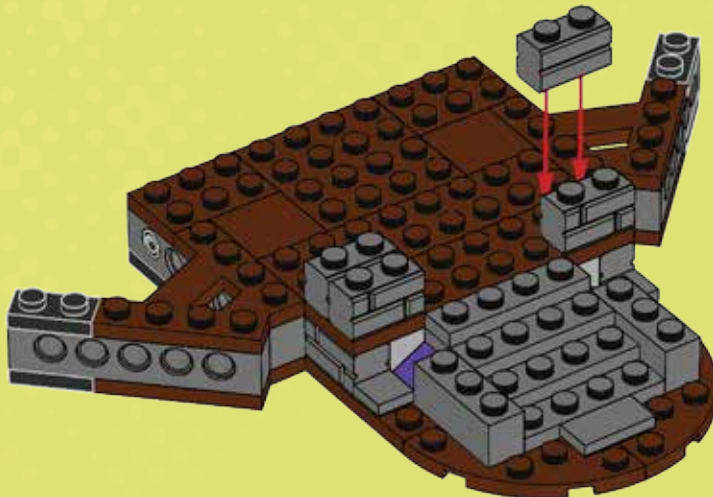

2x

# 20

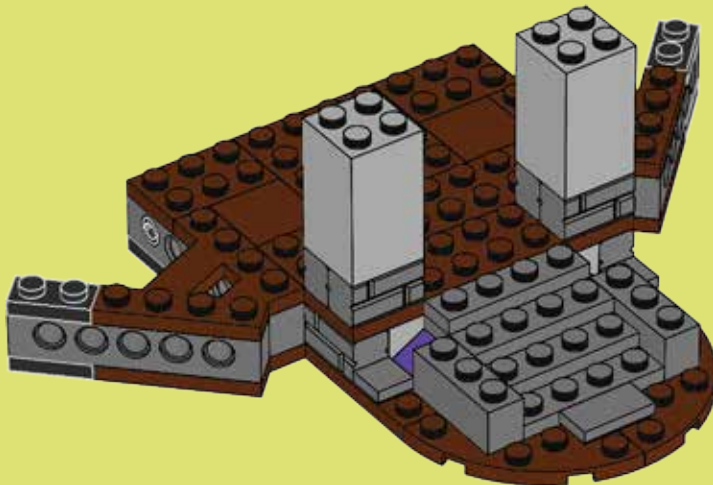



2x



2x

# 21

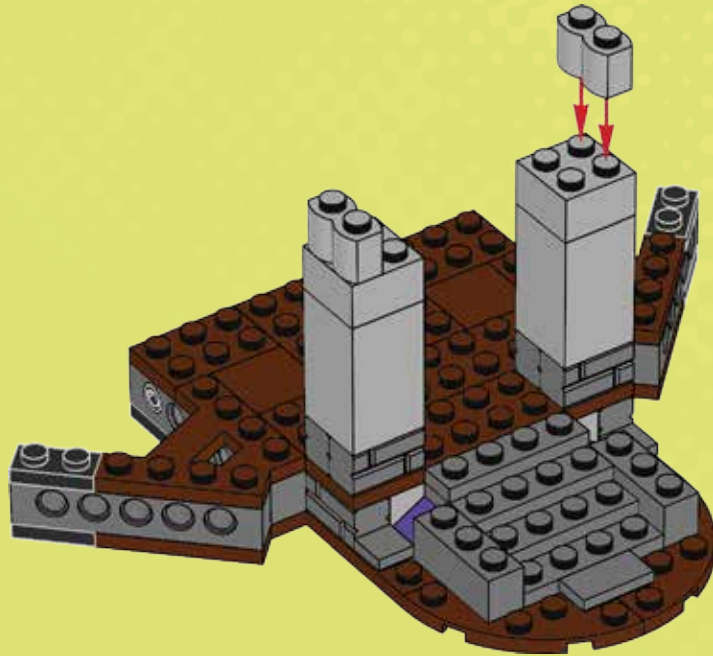

2x



2x

# 22

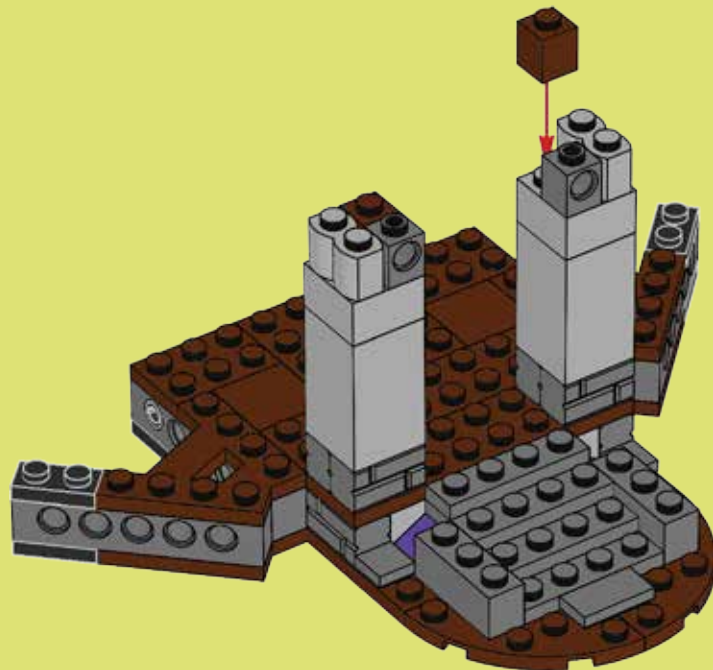

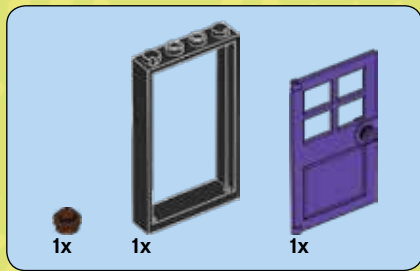

# 23

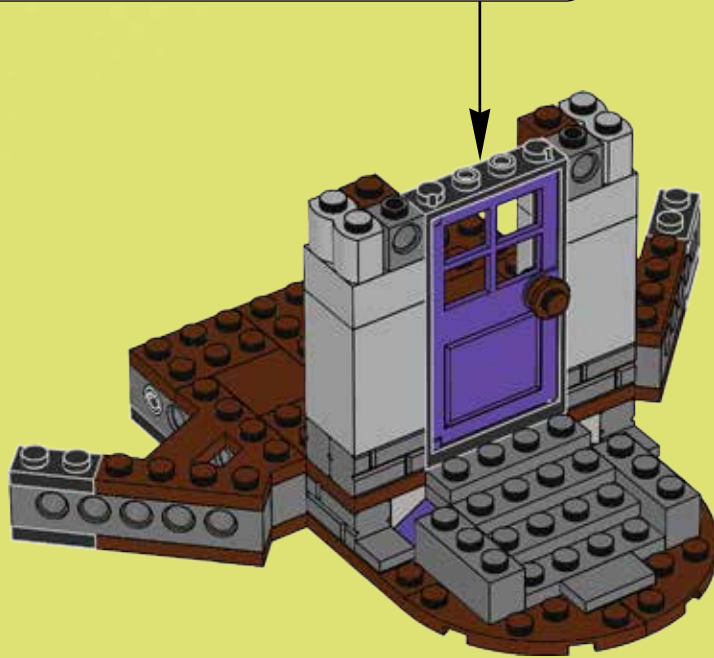
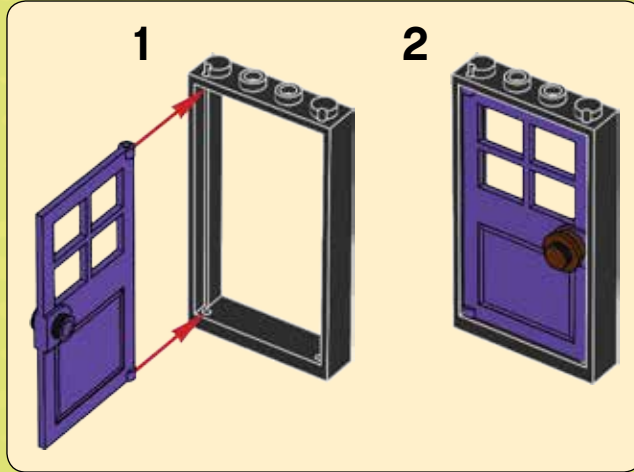



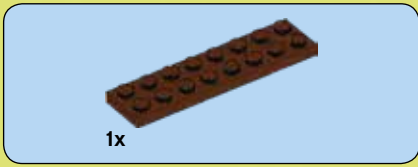

24

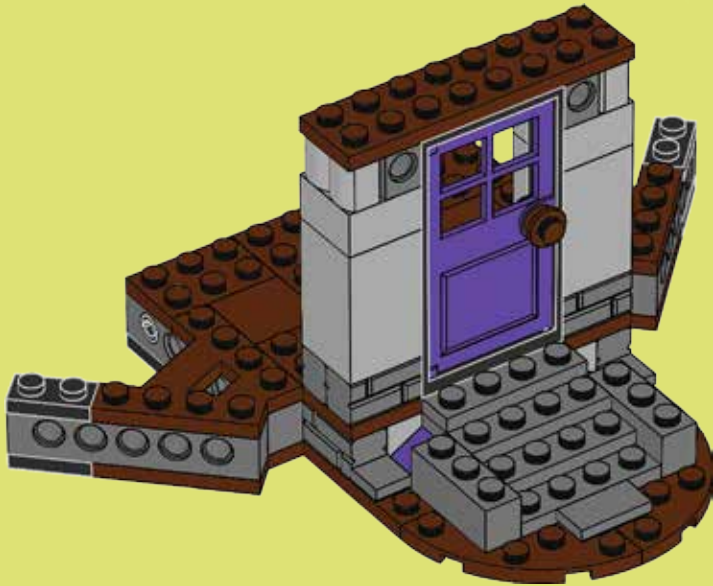

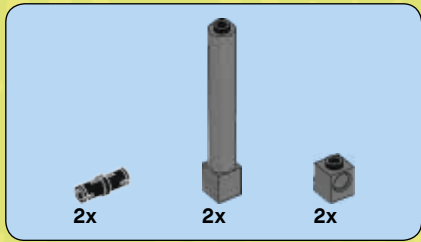

25

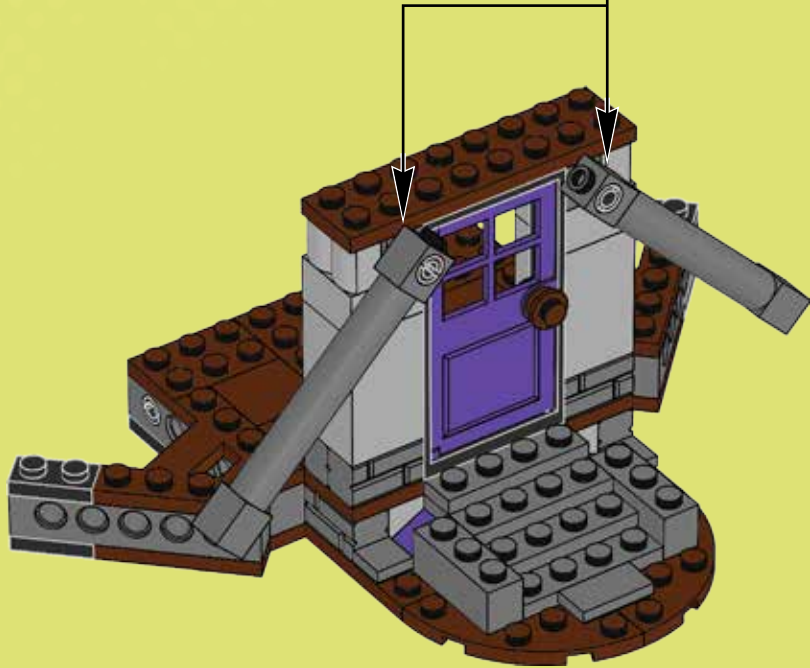
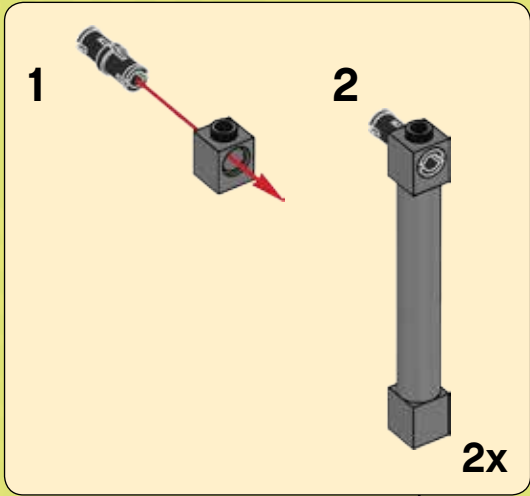

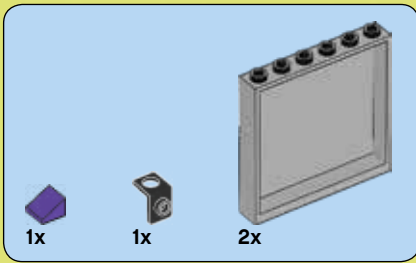

# 26

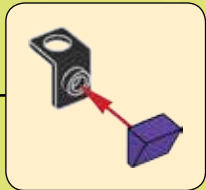
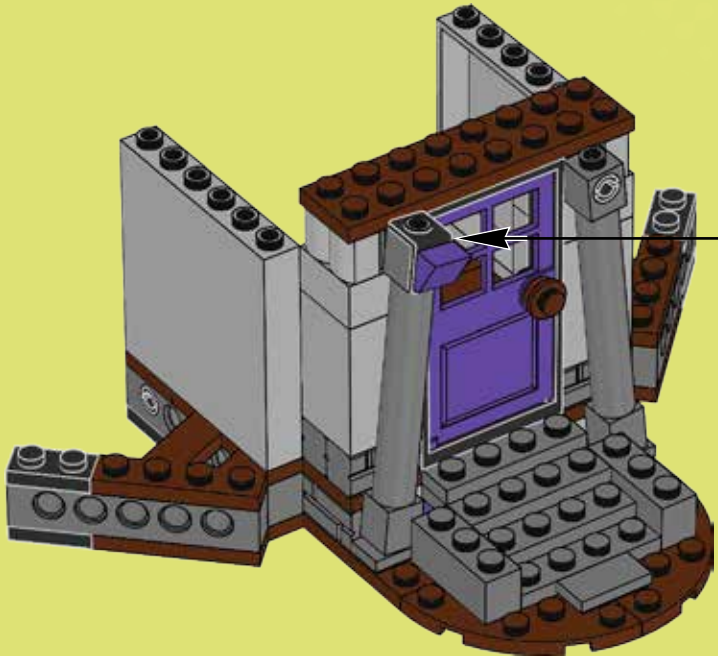

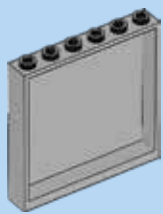

2x

# 27

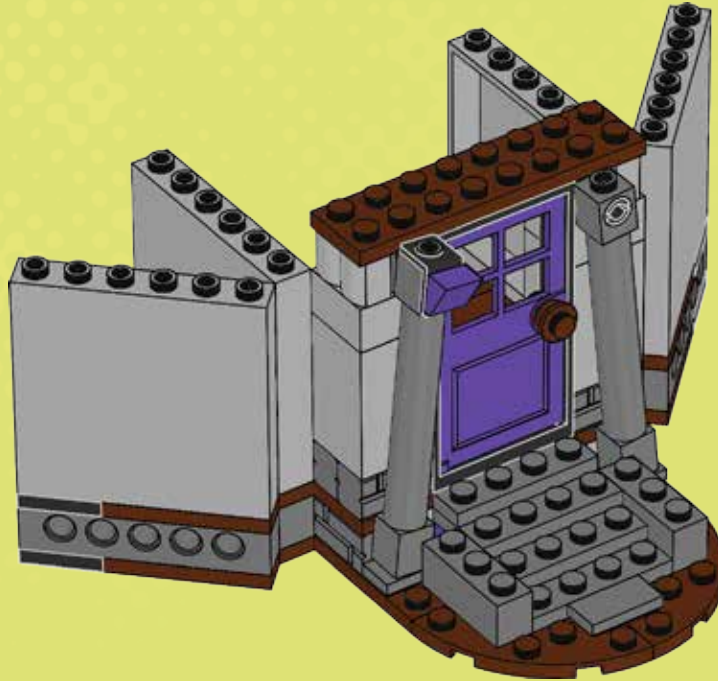

2x

# 28

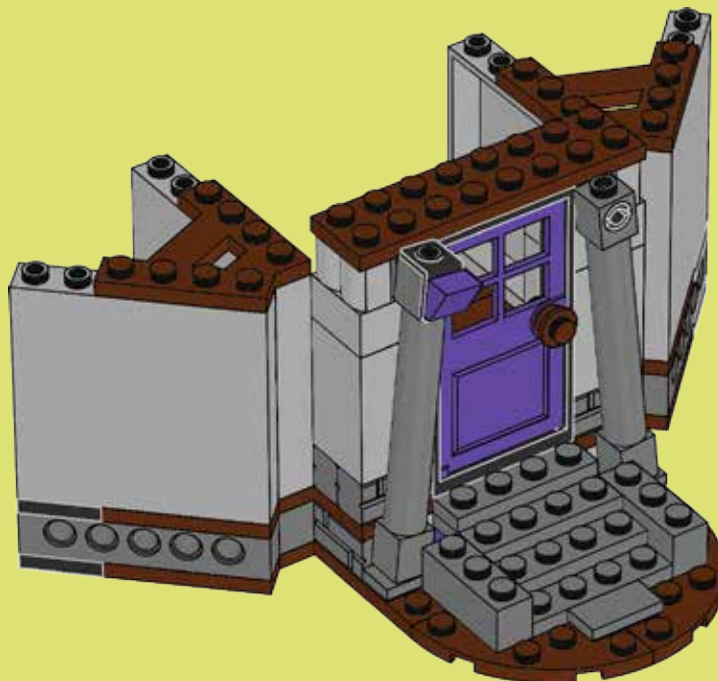





4x

# 29

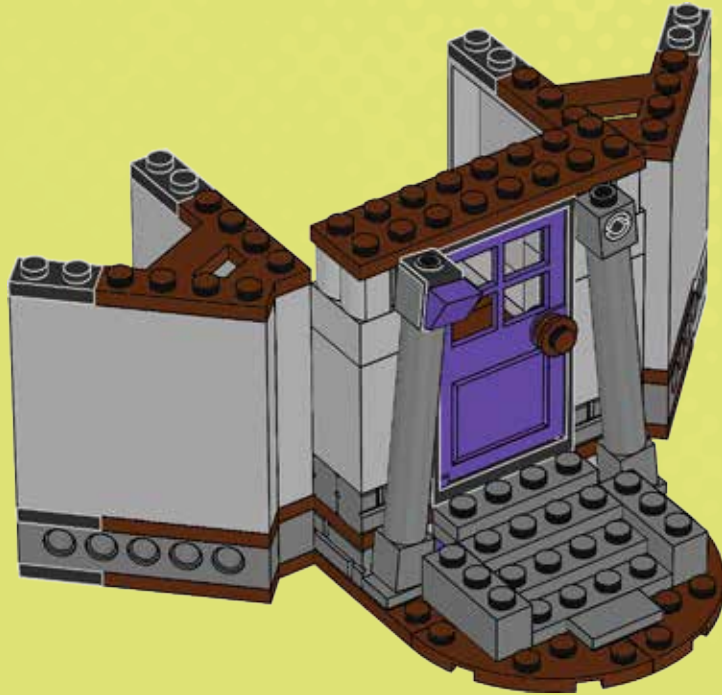

2x



2x

# 30

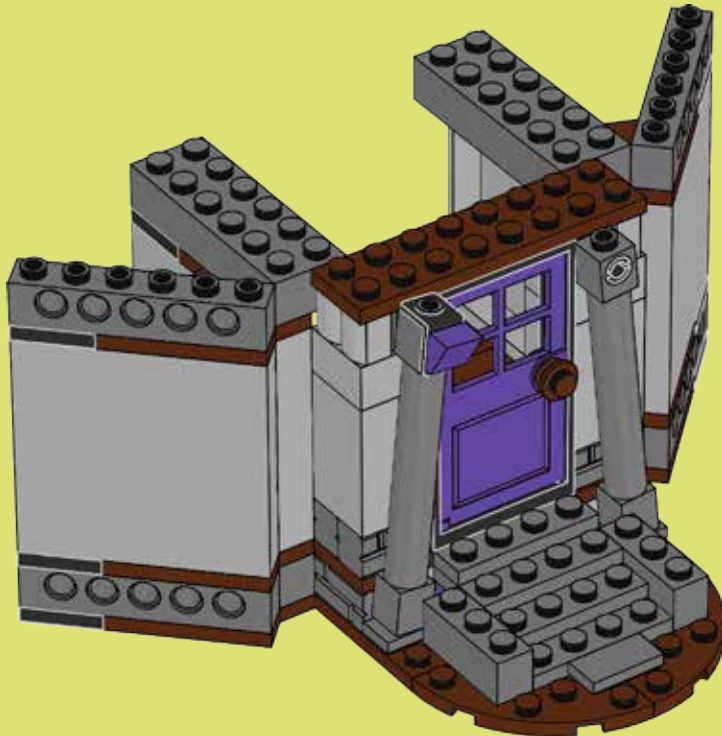



2x

# 31

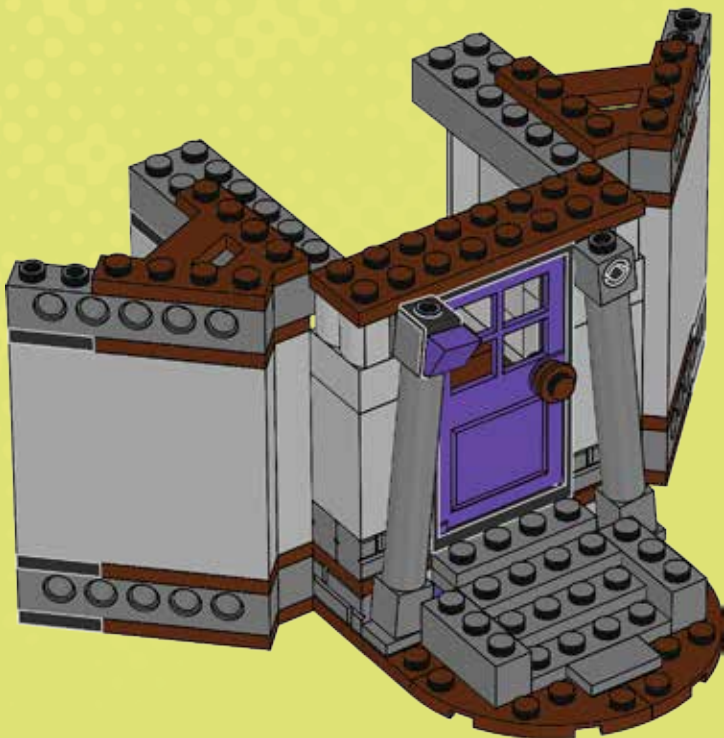

4x

# 32

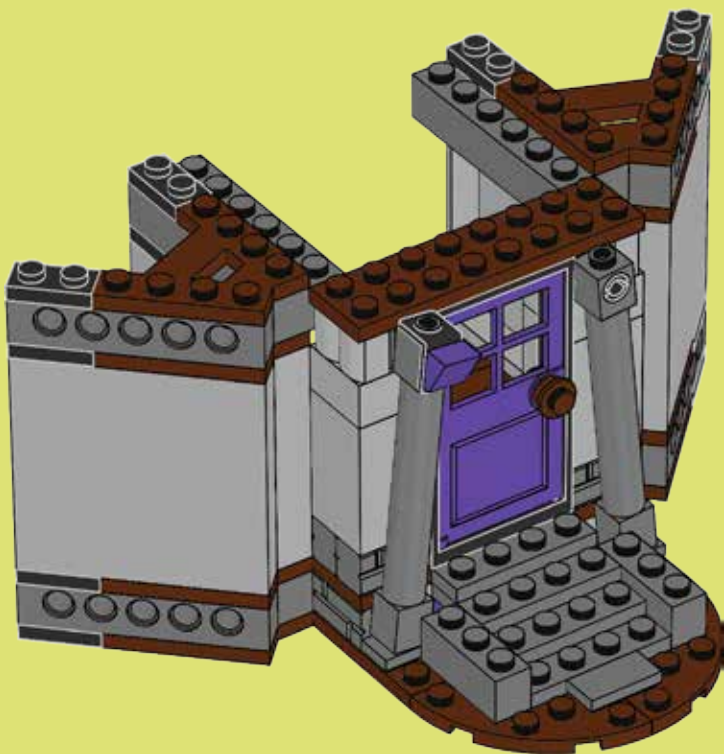

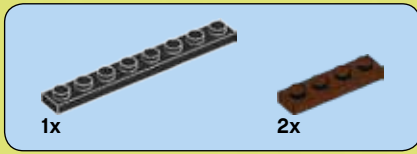

33

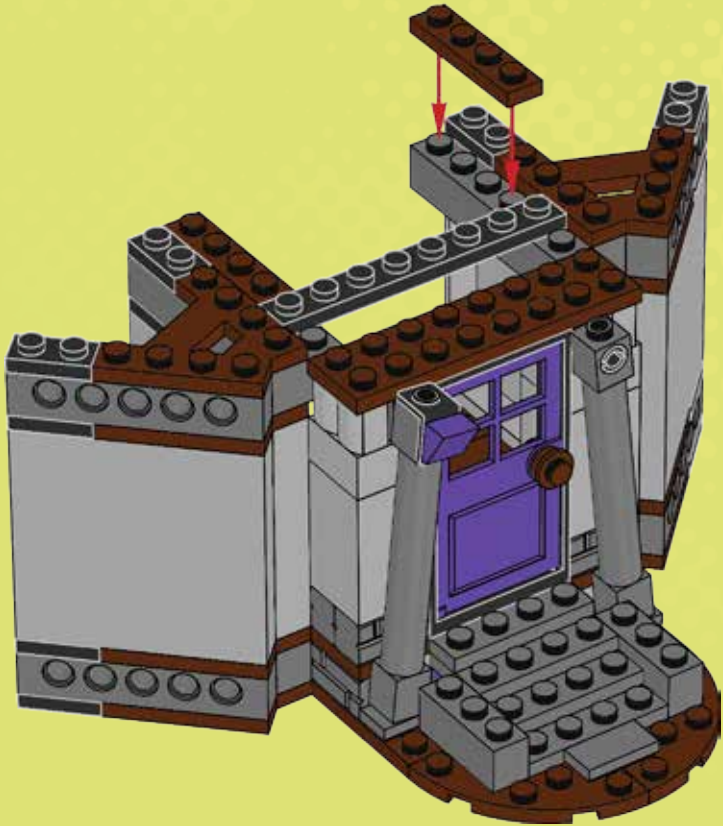

34

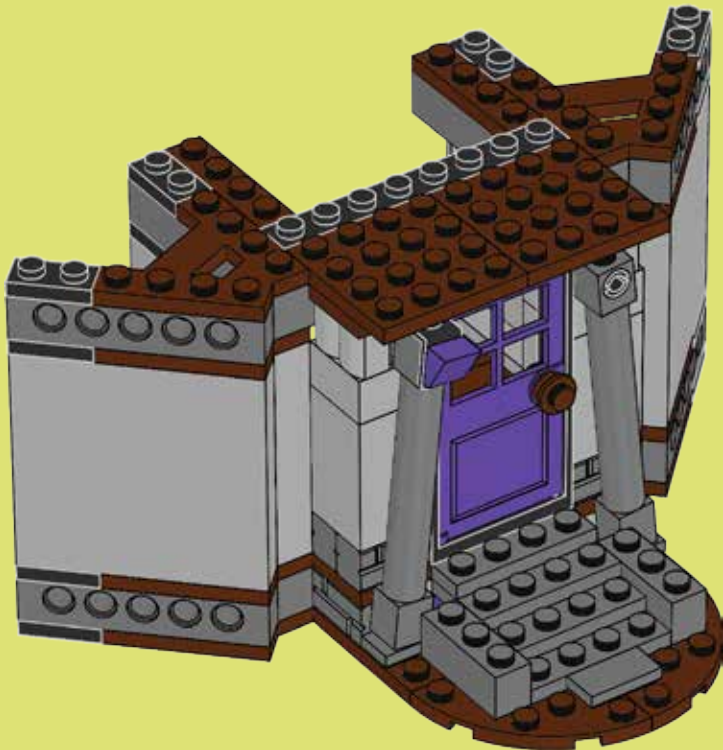



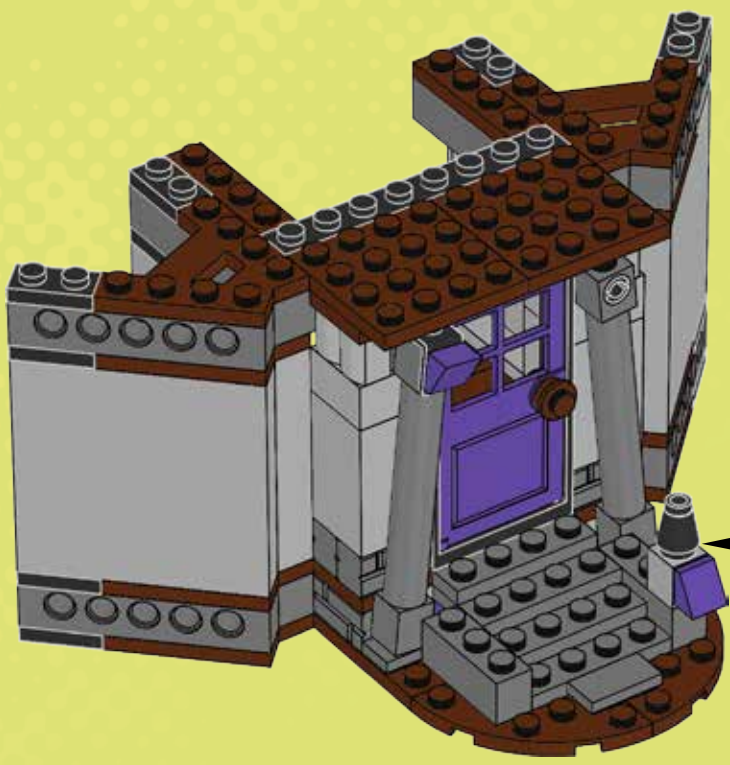

- 1x 
- 1x 
- 1x 

# 35





1  

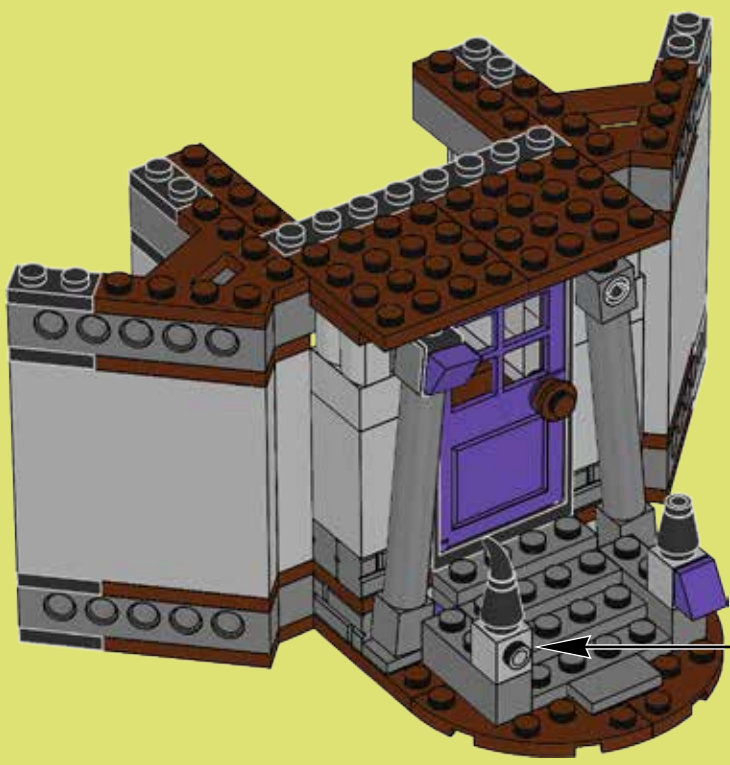

2 

- 1x 
- 1x 
- 1x 

# 36



1  

2  



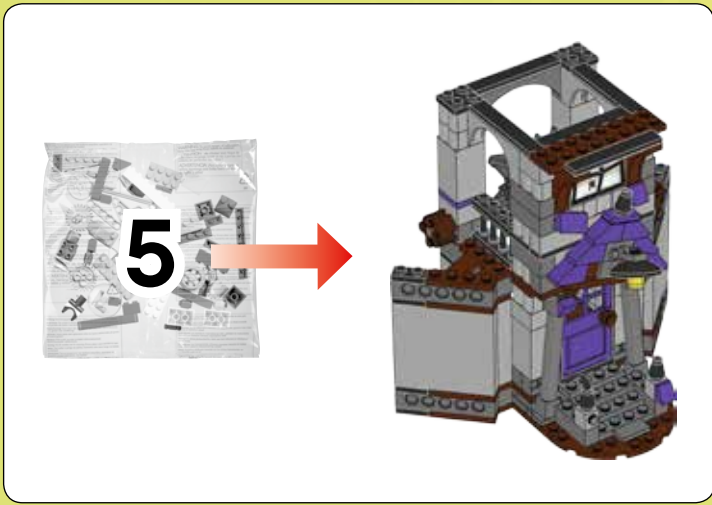

37

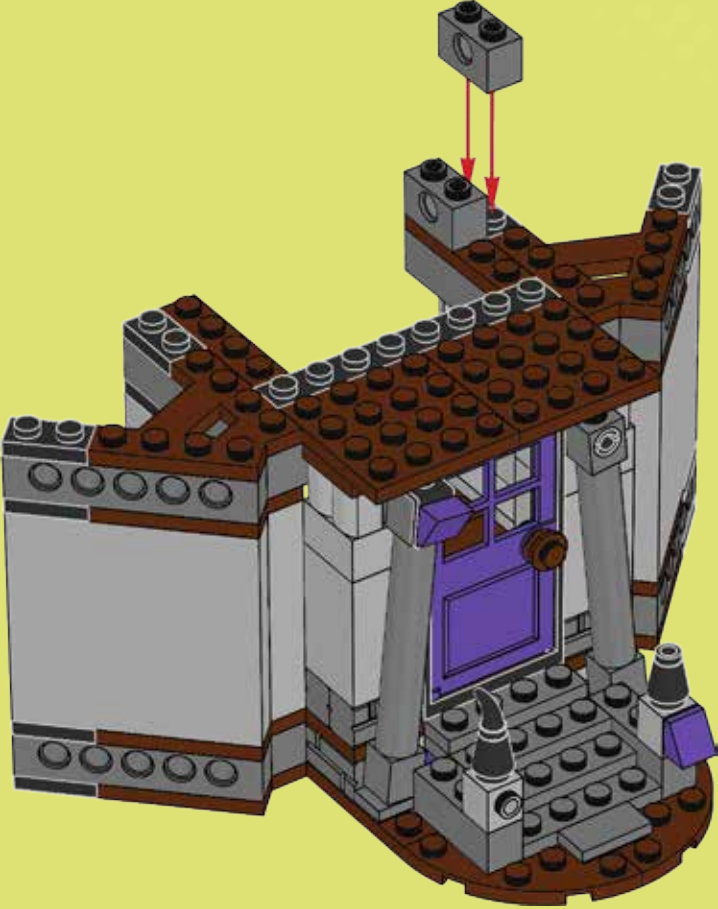

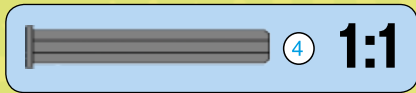

# 38

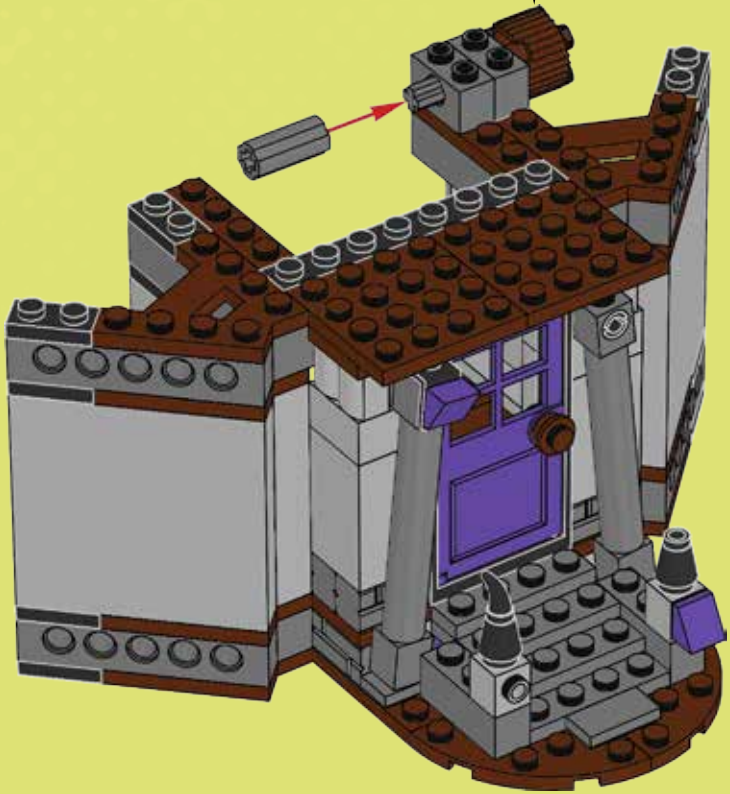
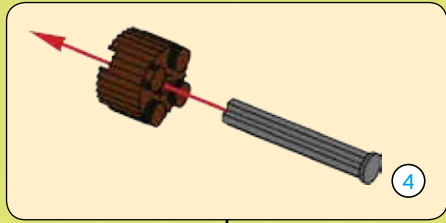

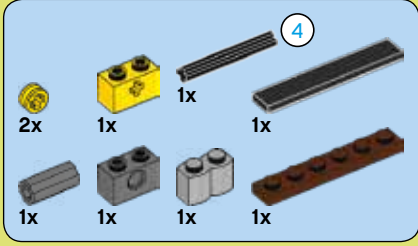

# 39

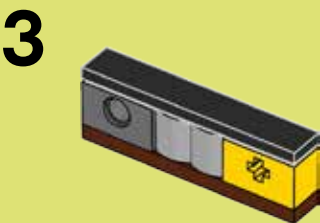
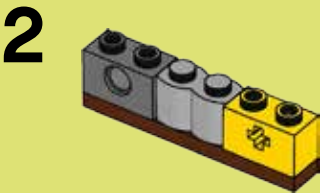

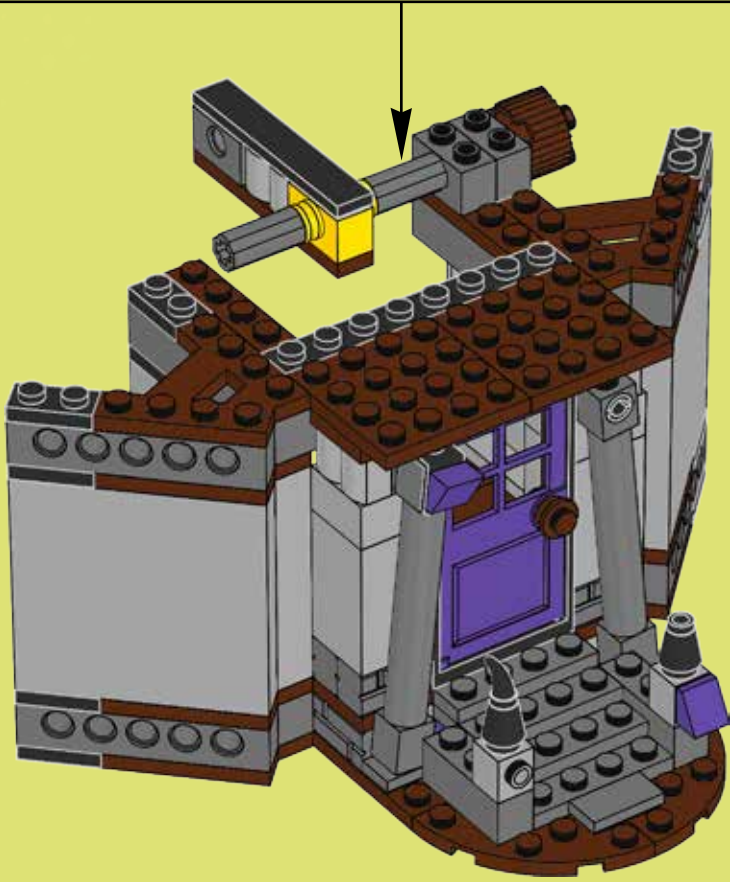
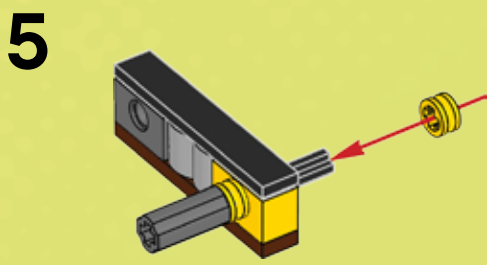
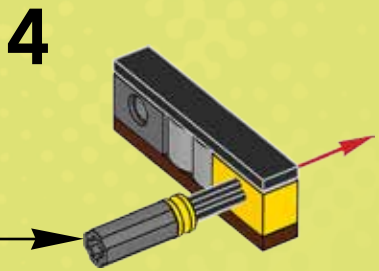
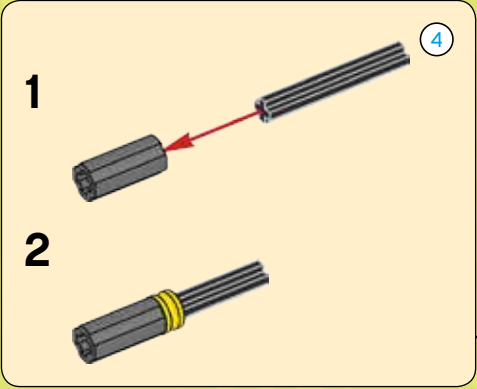





2x

# 40

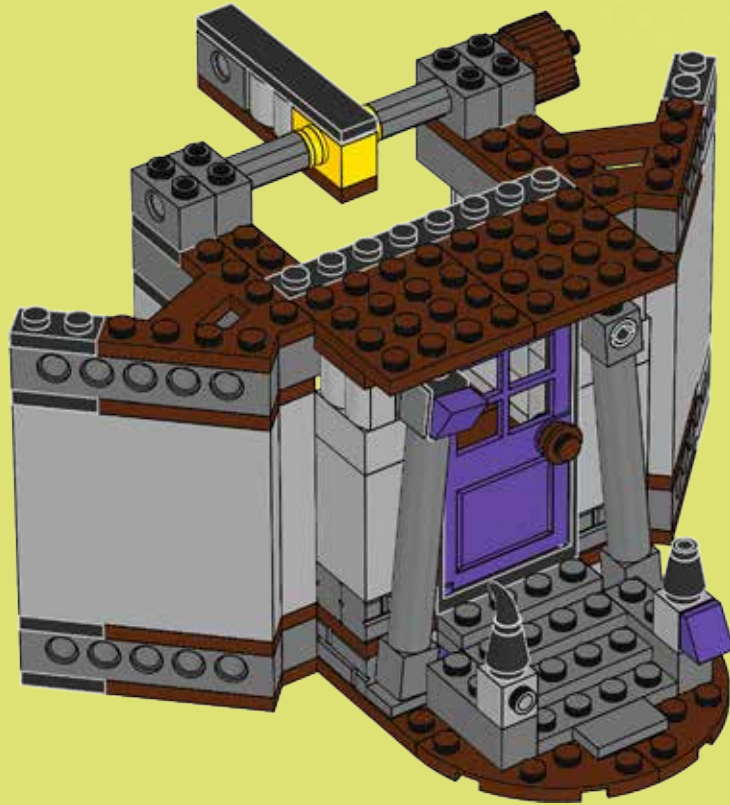

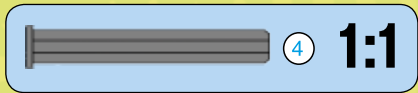
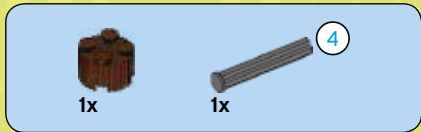

# 41

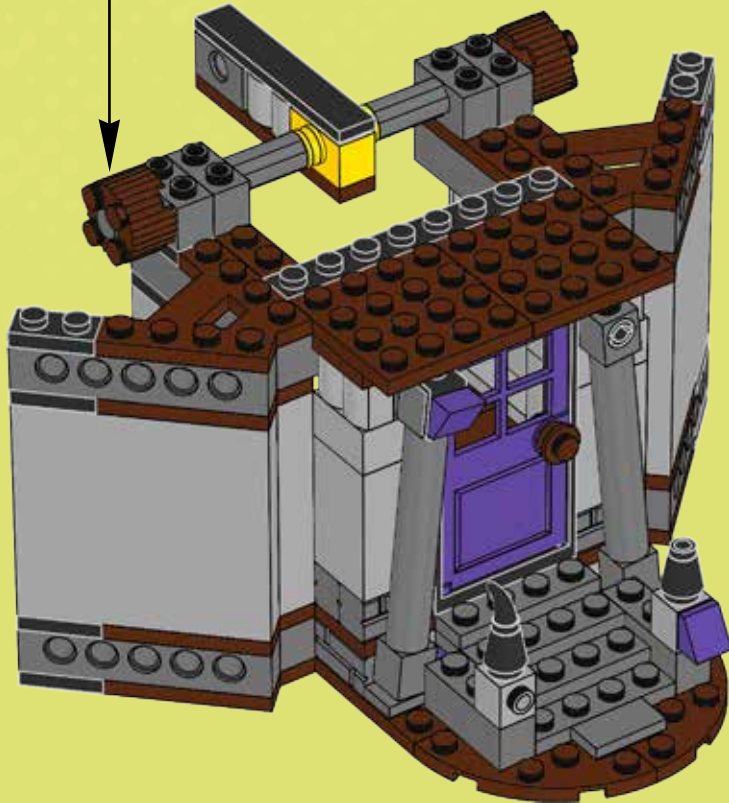
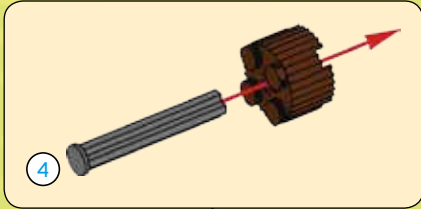

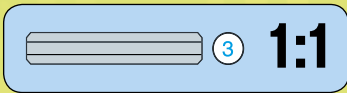
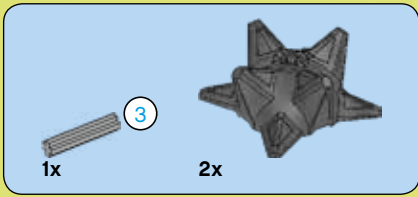

42

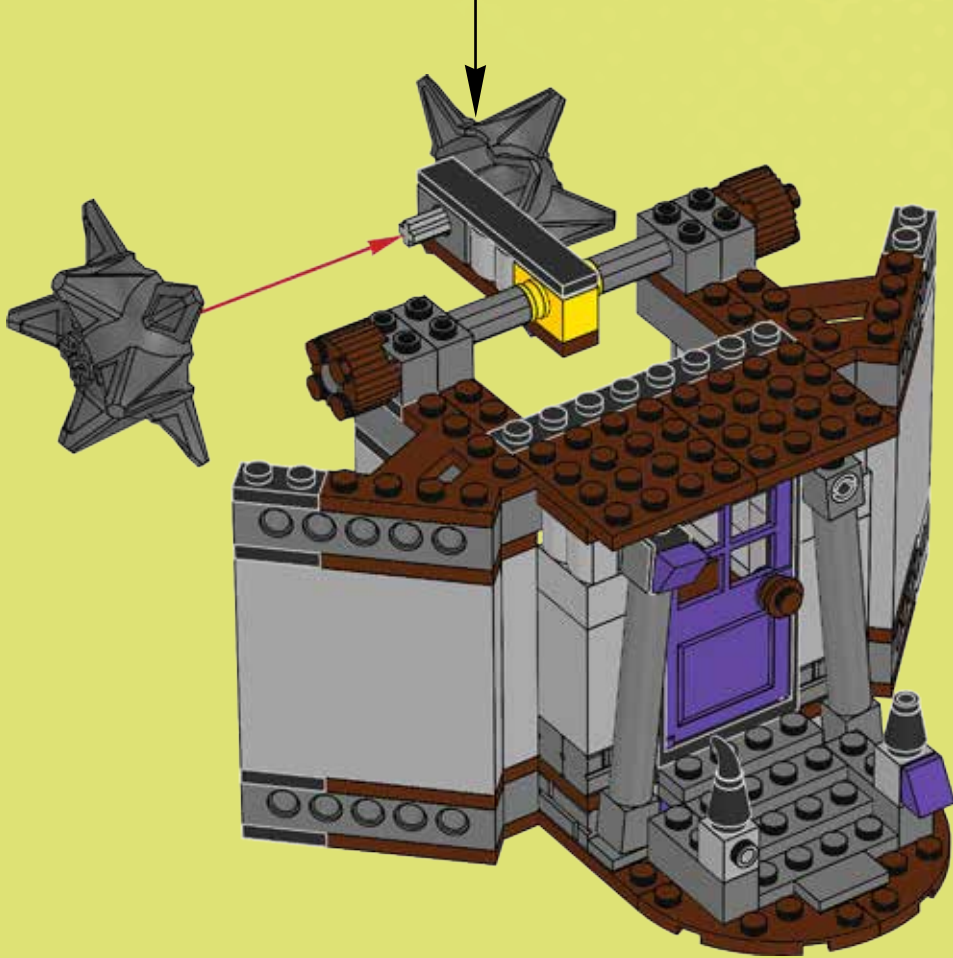
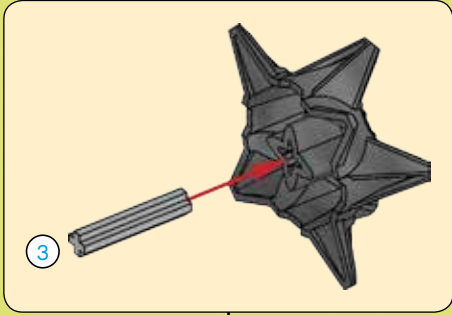

43

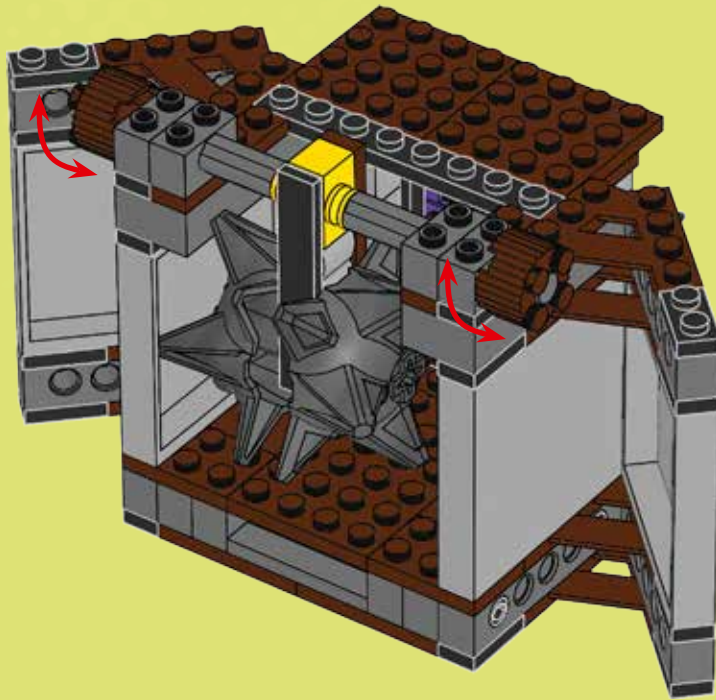



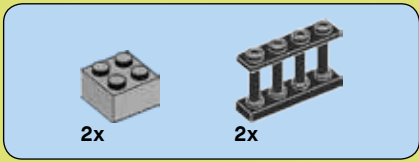

# 44

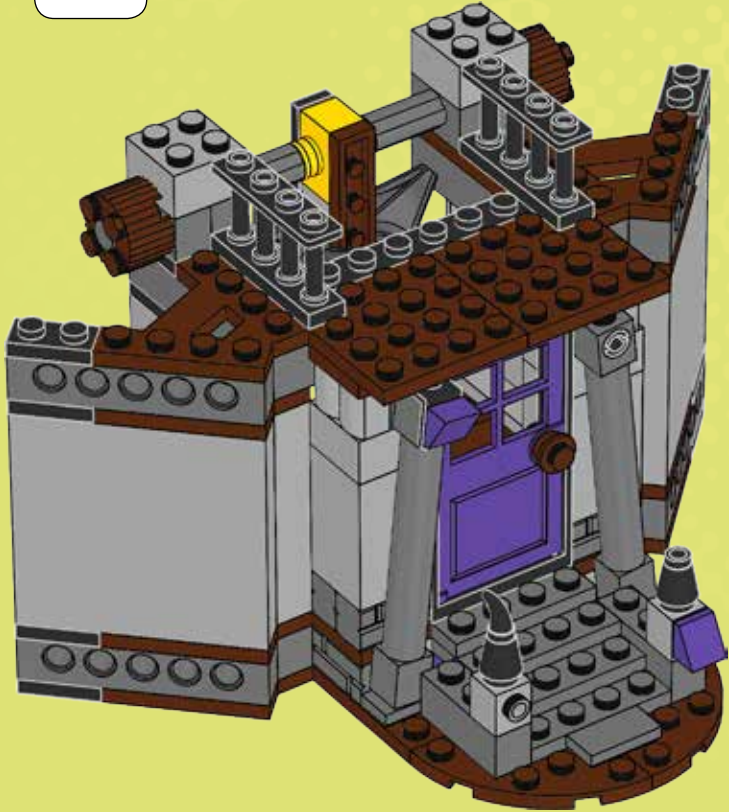

# 45

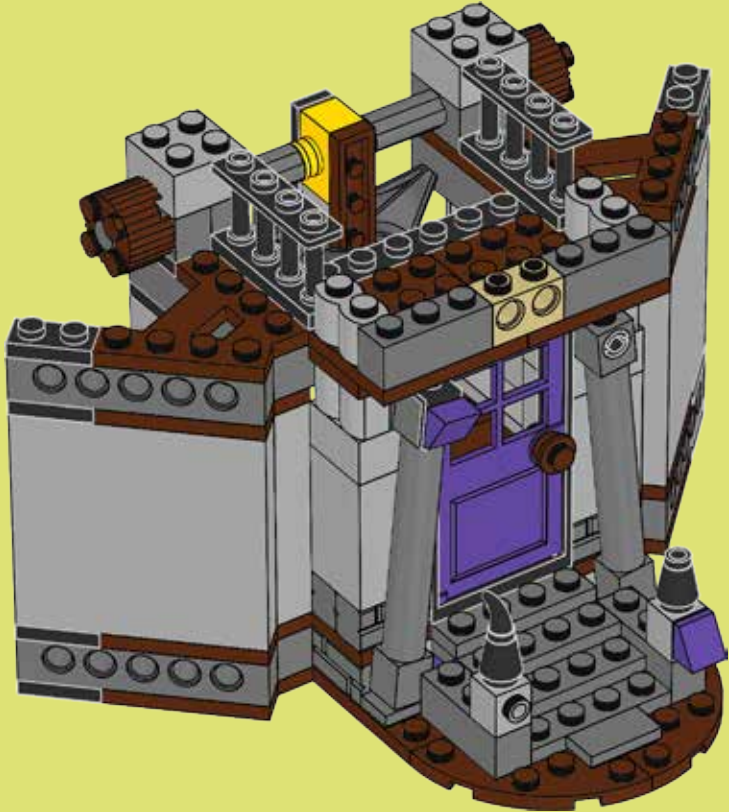

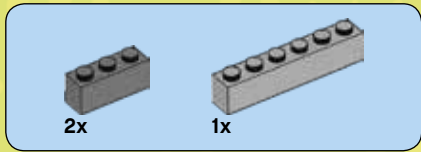

46

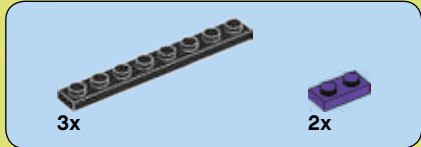
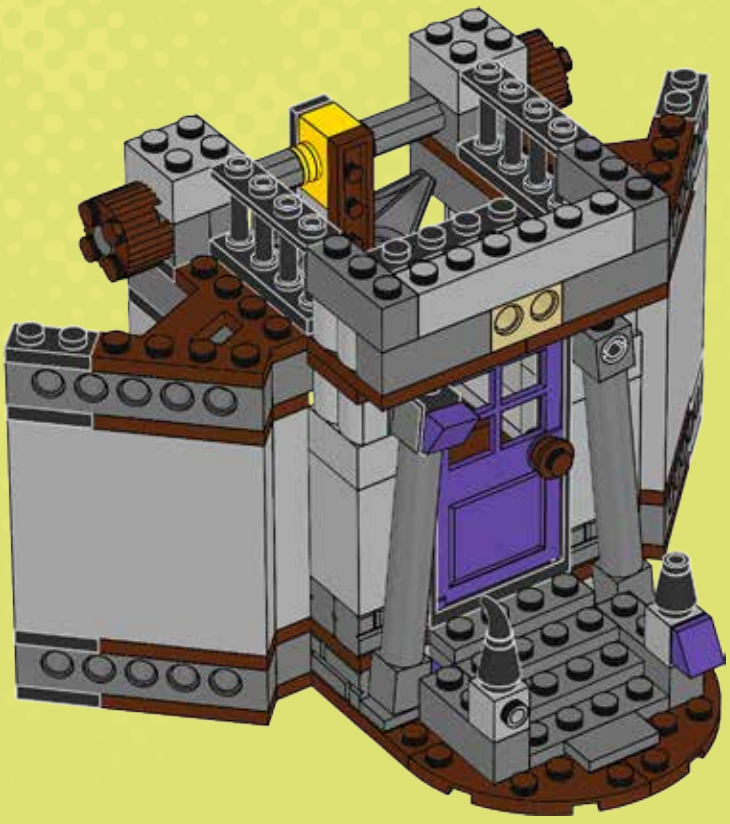

47

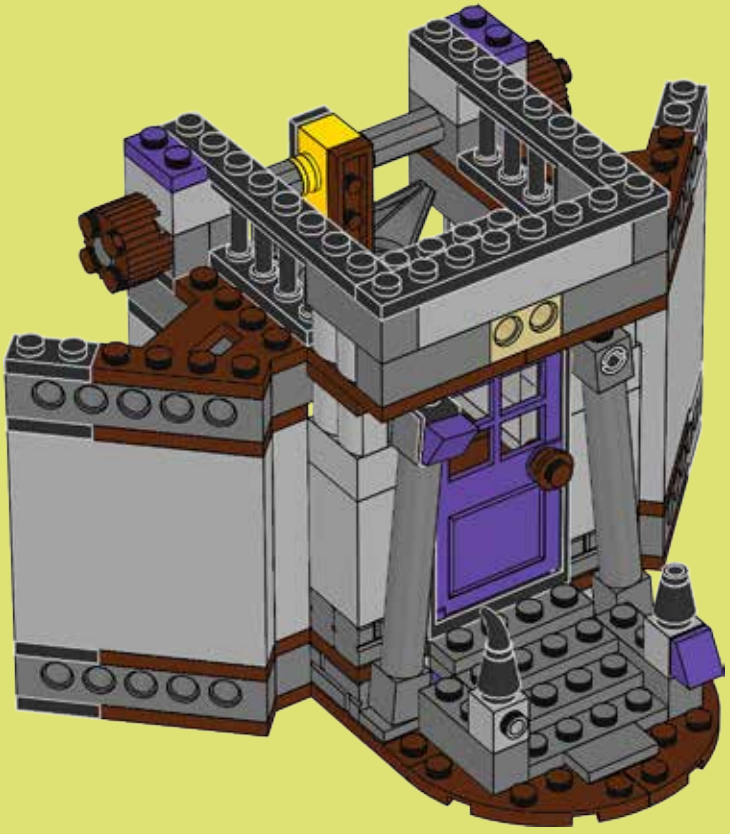

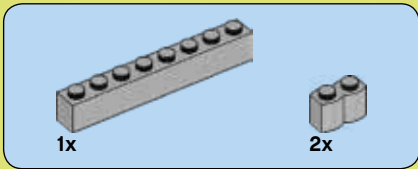

48

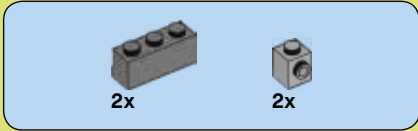
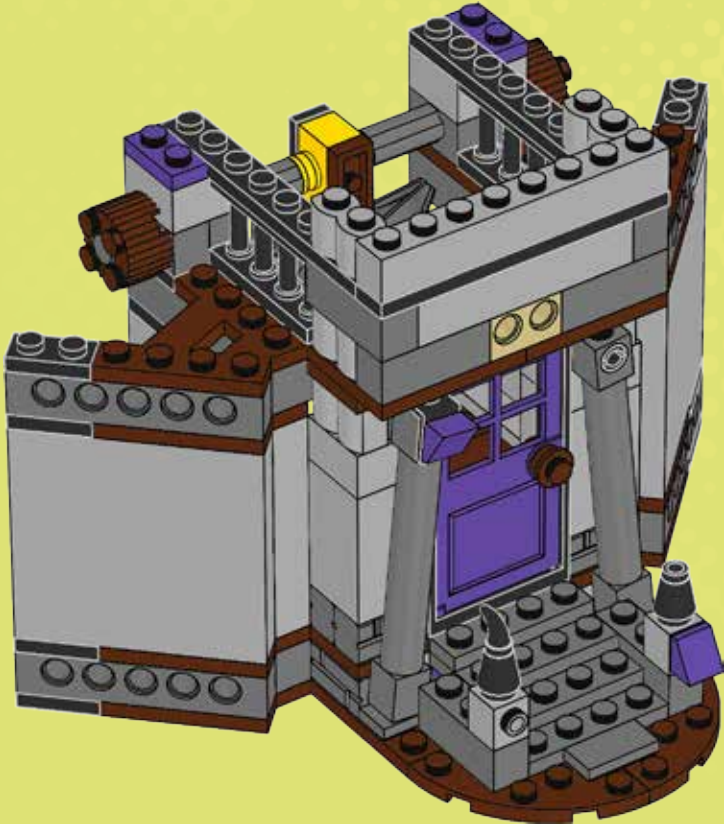

49

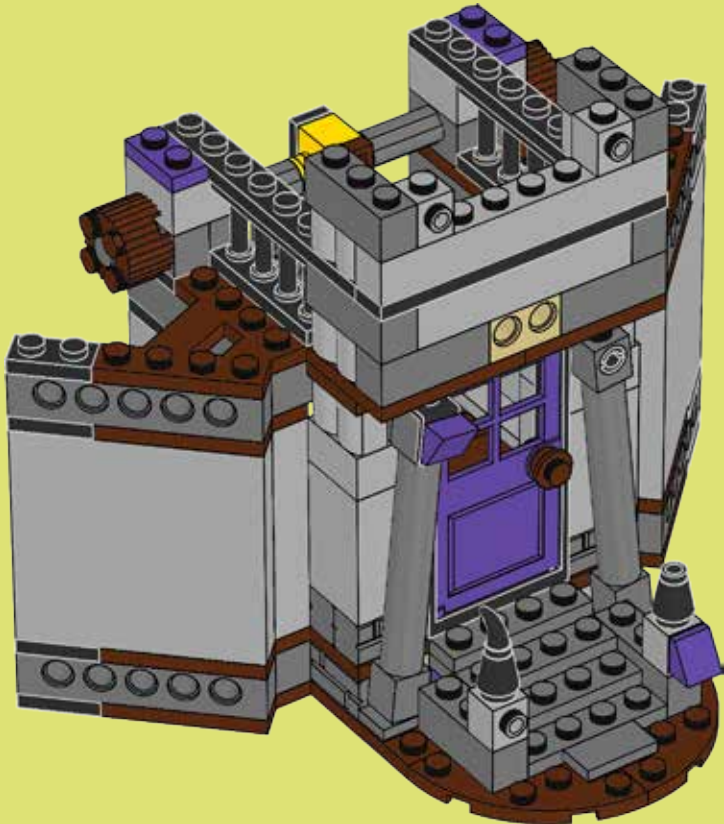





1x



2x

# 50

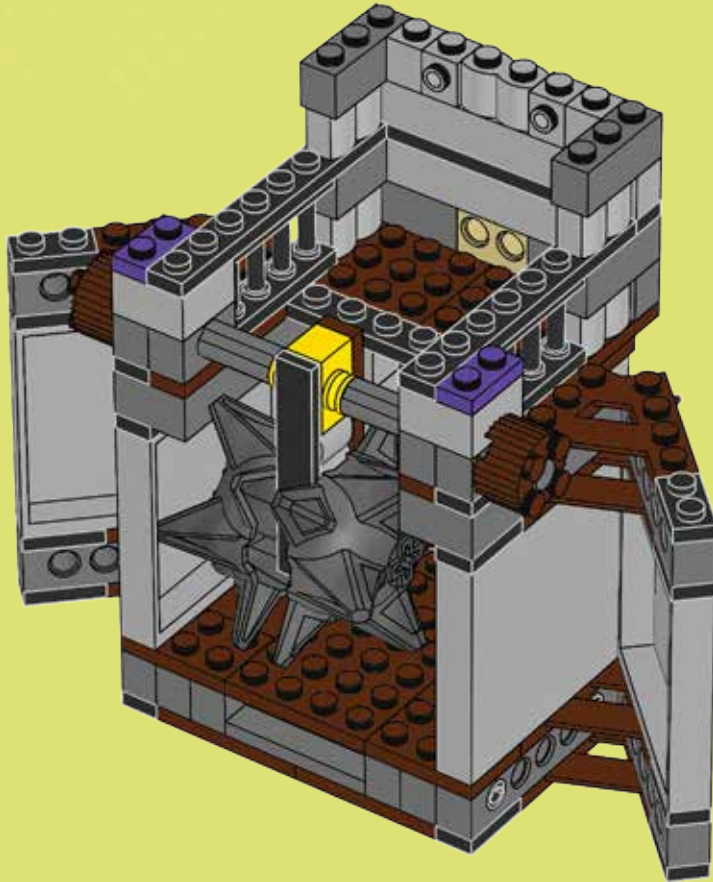



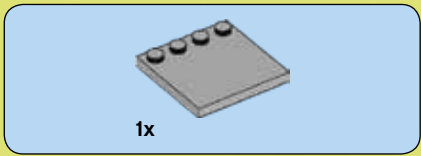

# 51

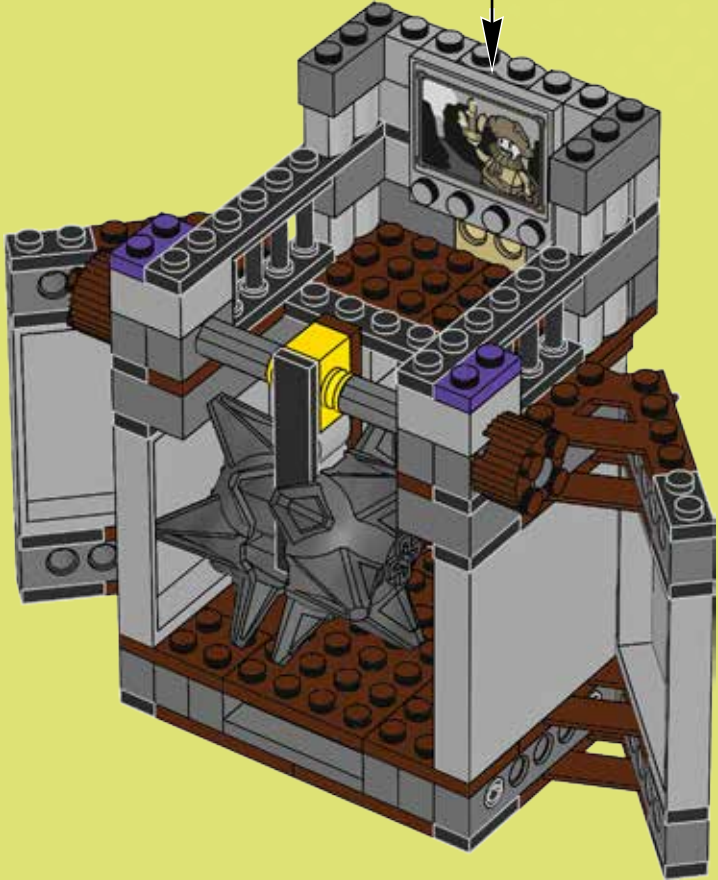
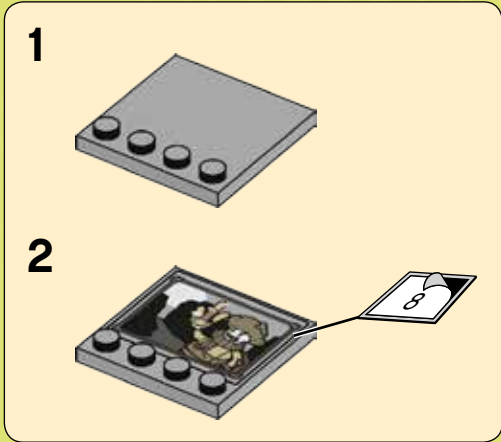

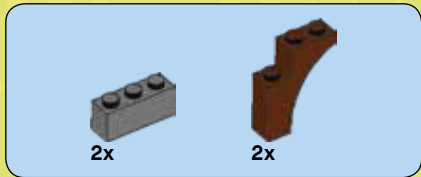

# 52

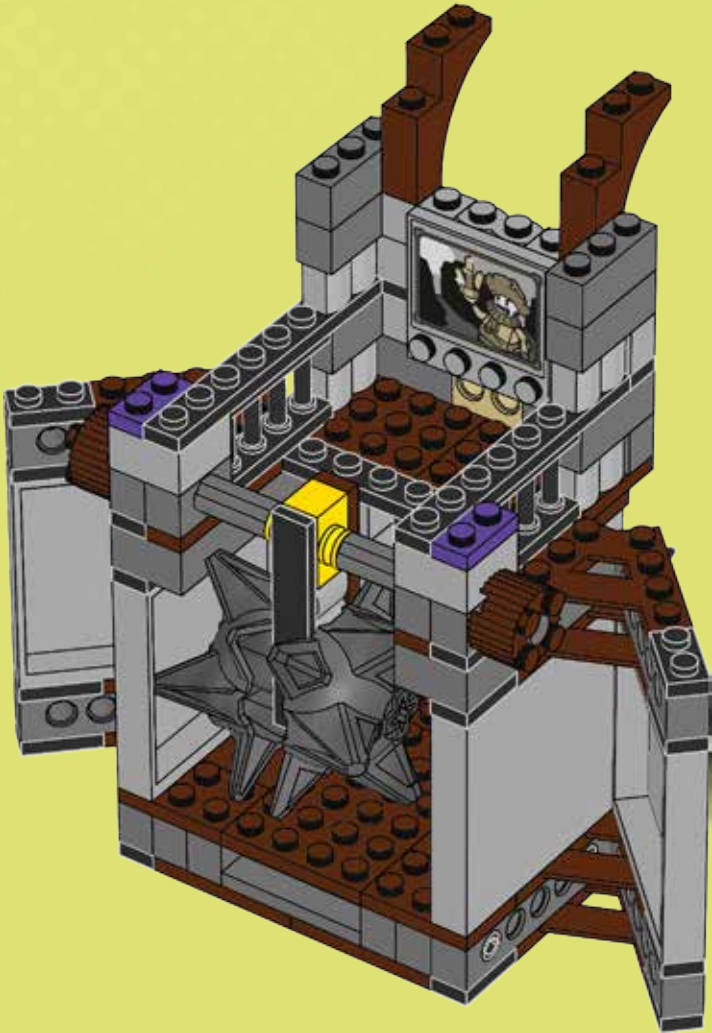

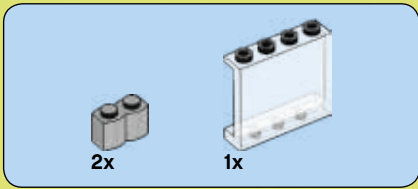

# 53

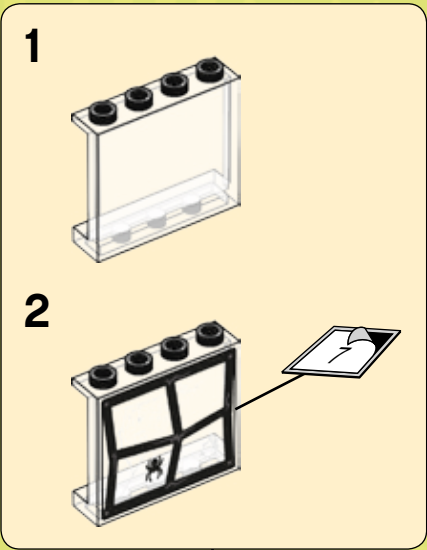

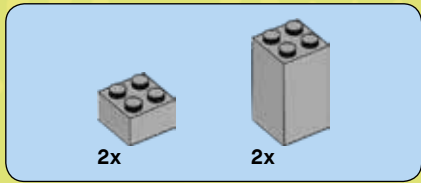

# 54





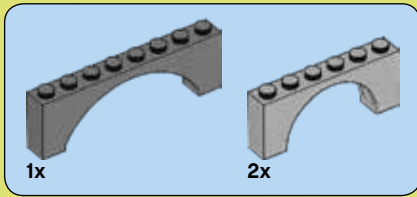

# 55

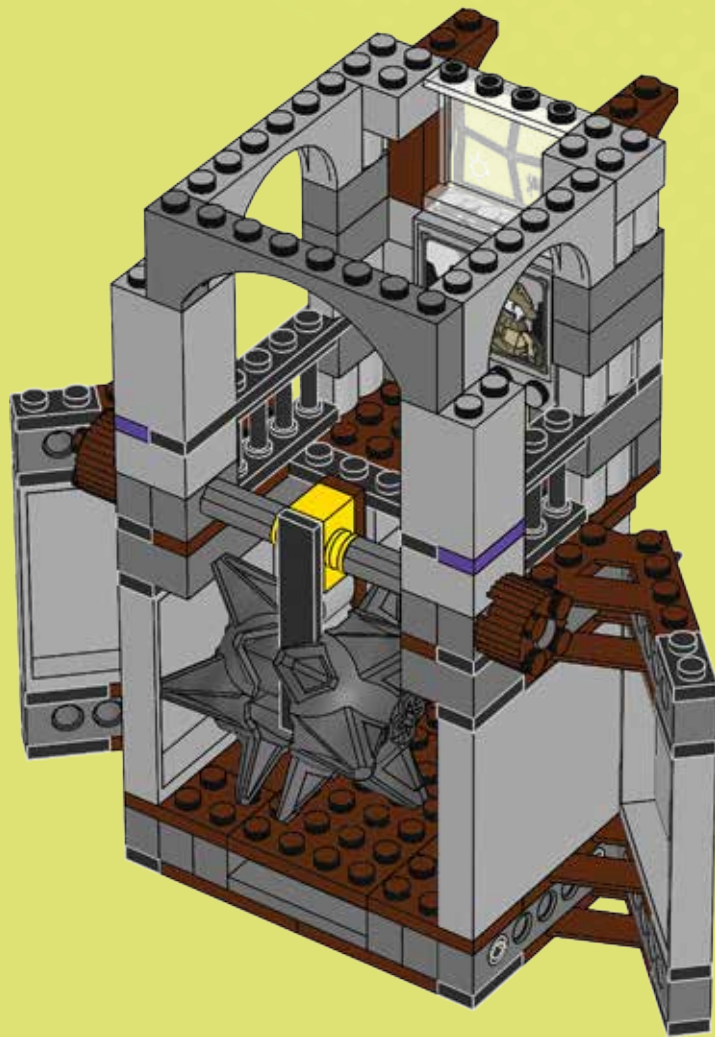



4x

# 56

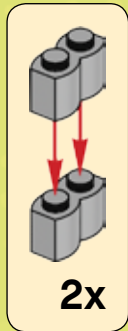

2x

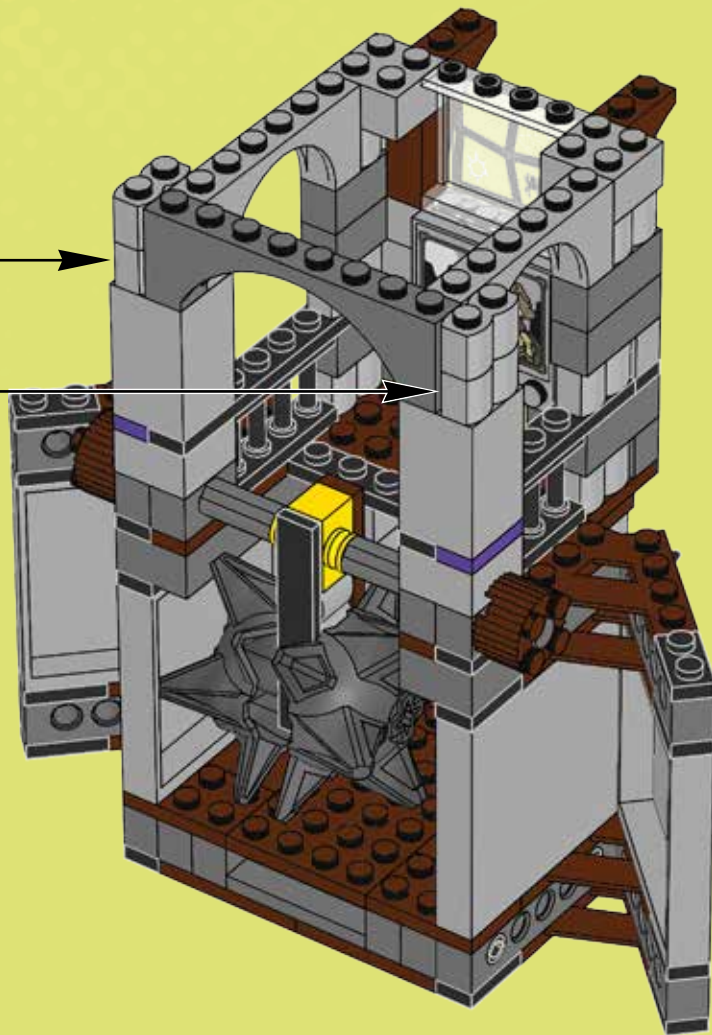

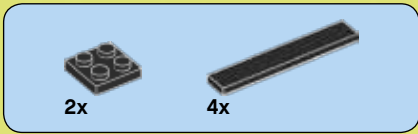

# 57

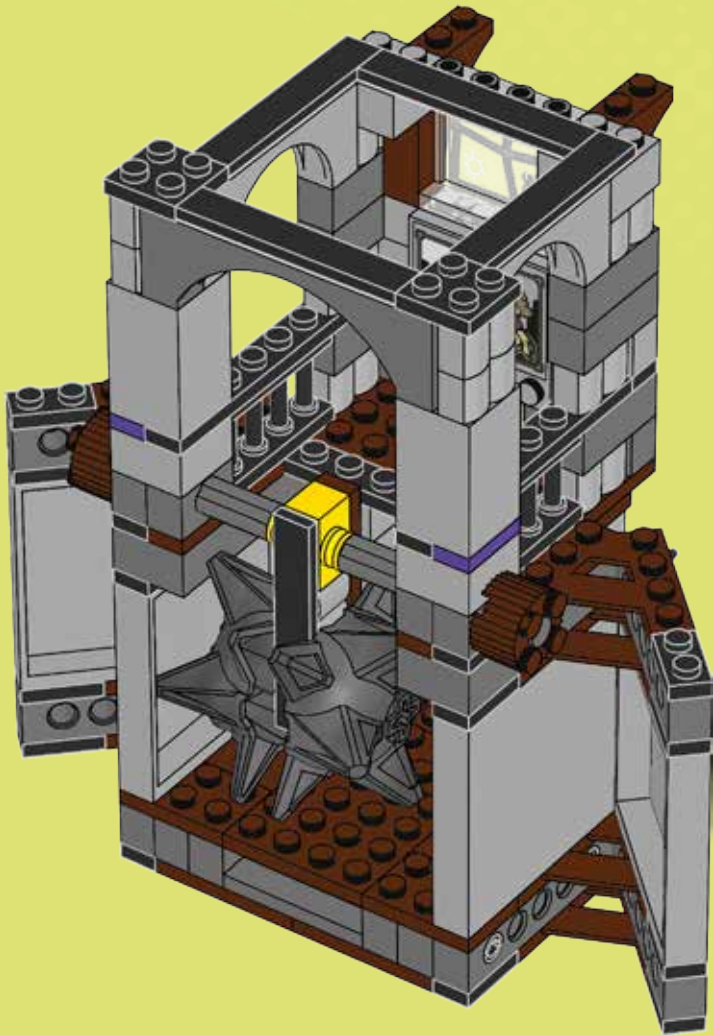

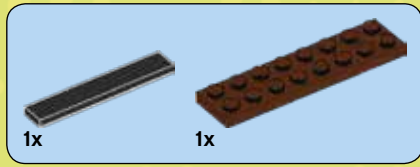

# 58

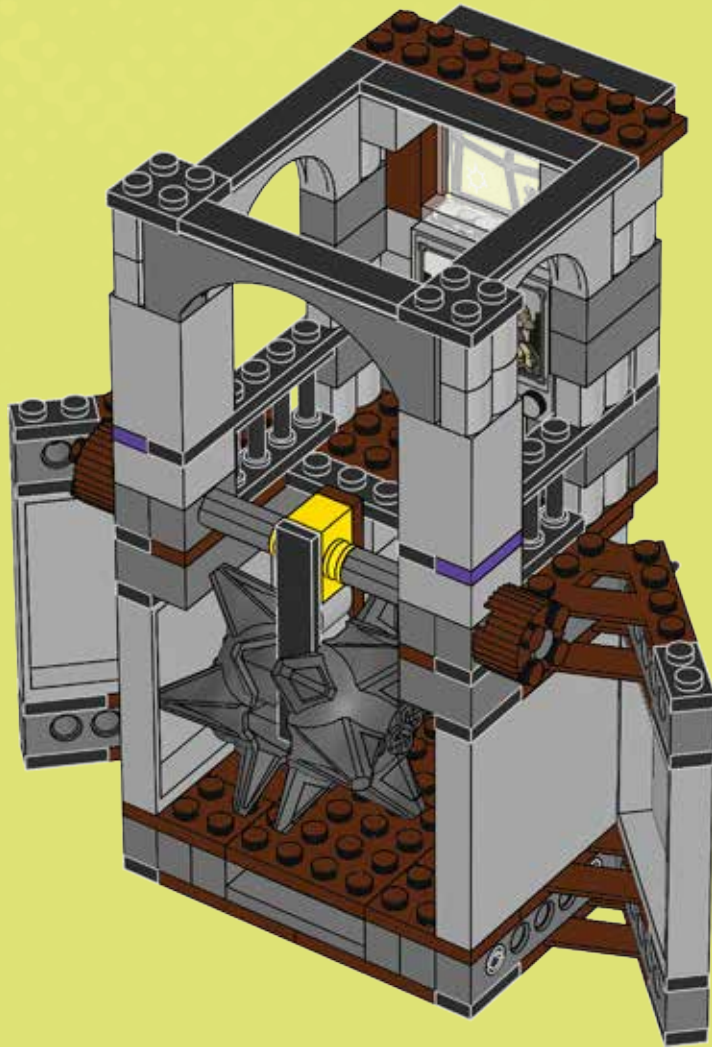





# 59

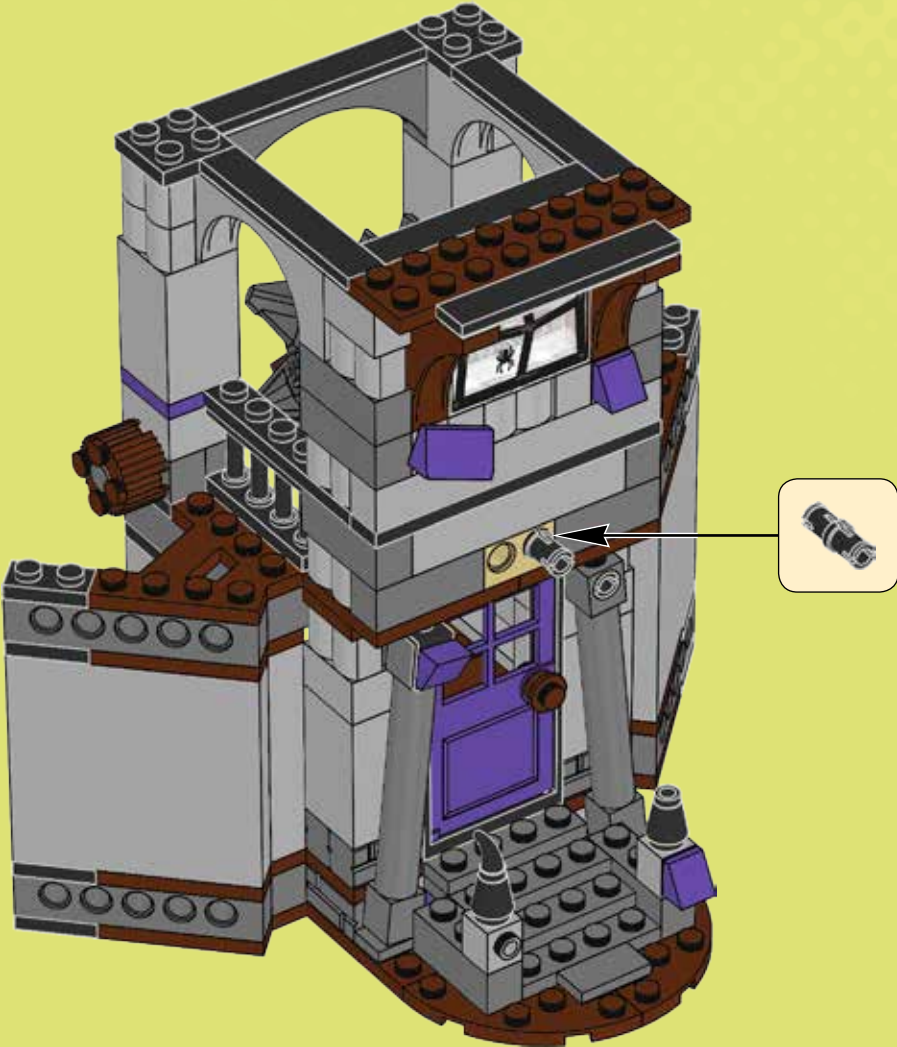



1

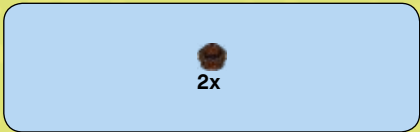

2



3

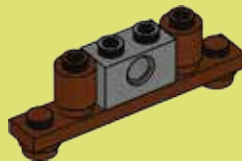

4

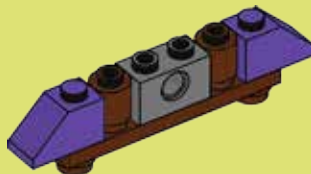



1x



2x

5

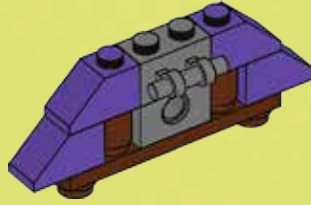

2x

6

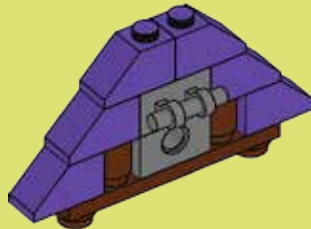

1x



1x

7

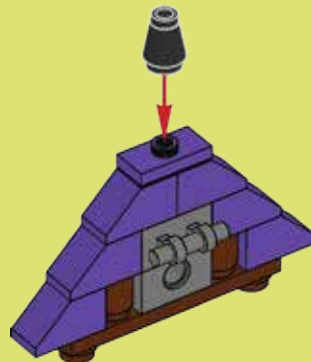



8

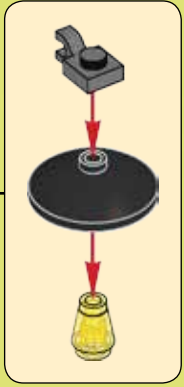
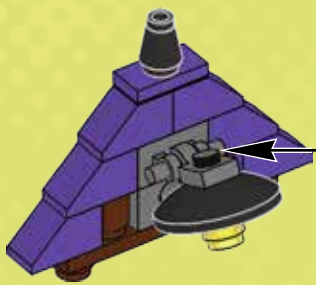

60

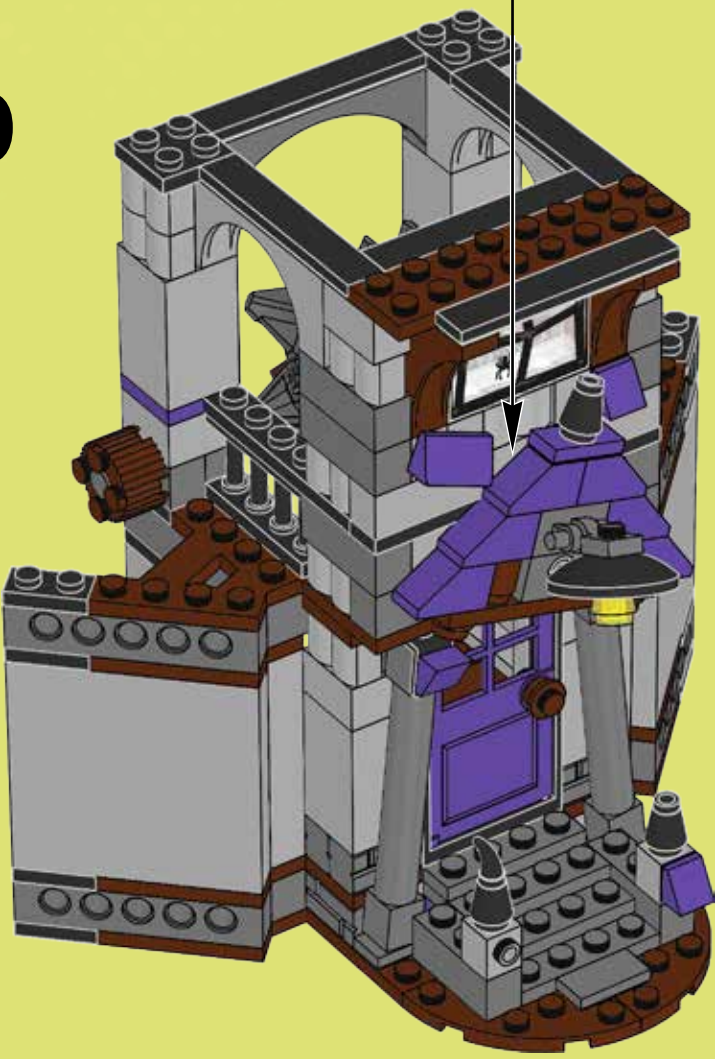



61

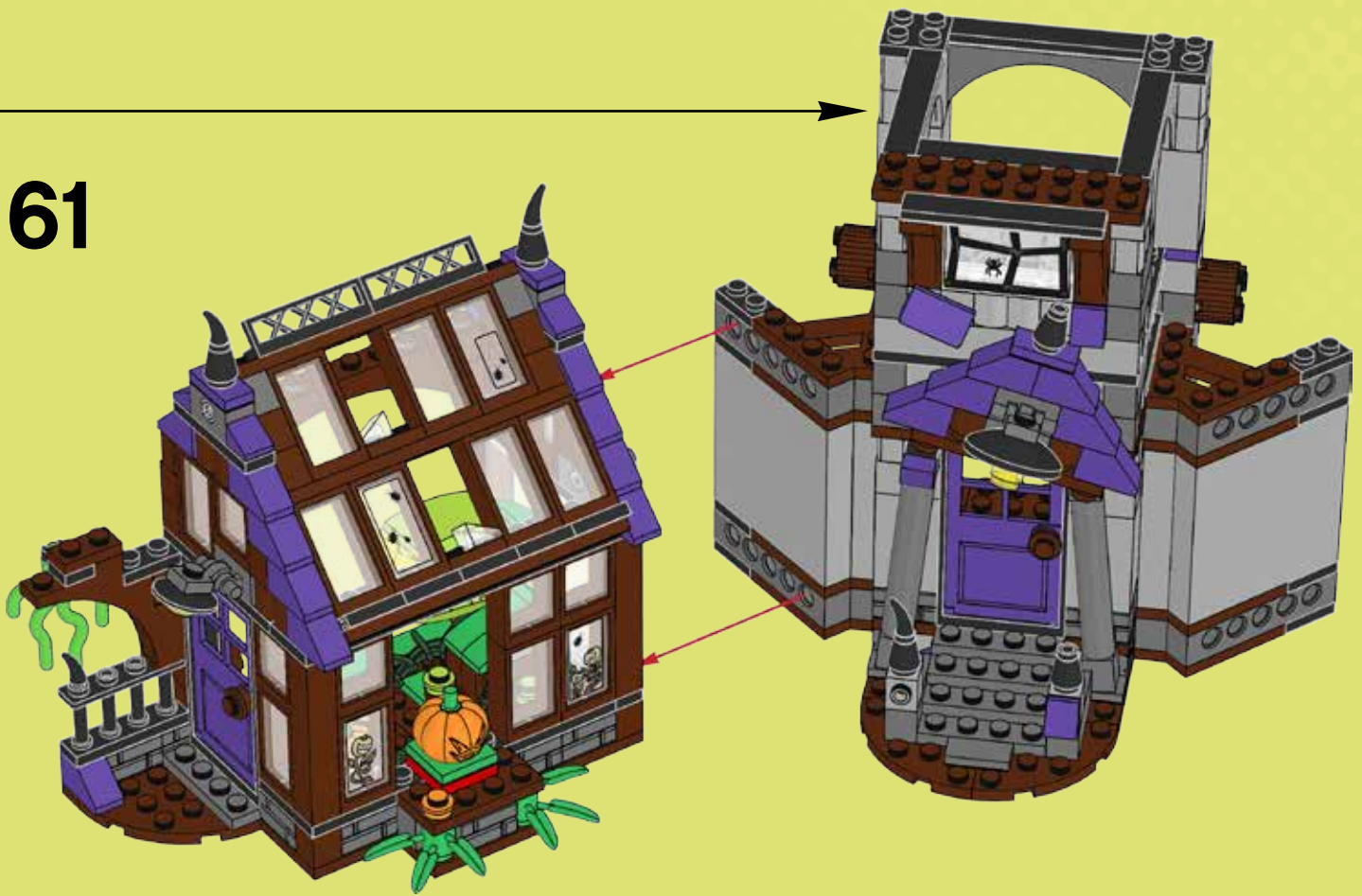

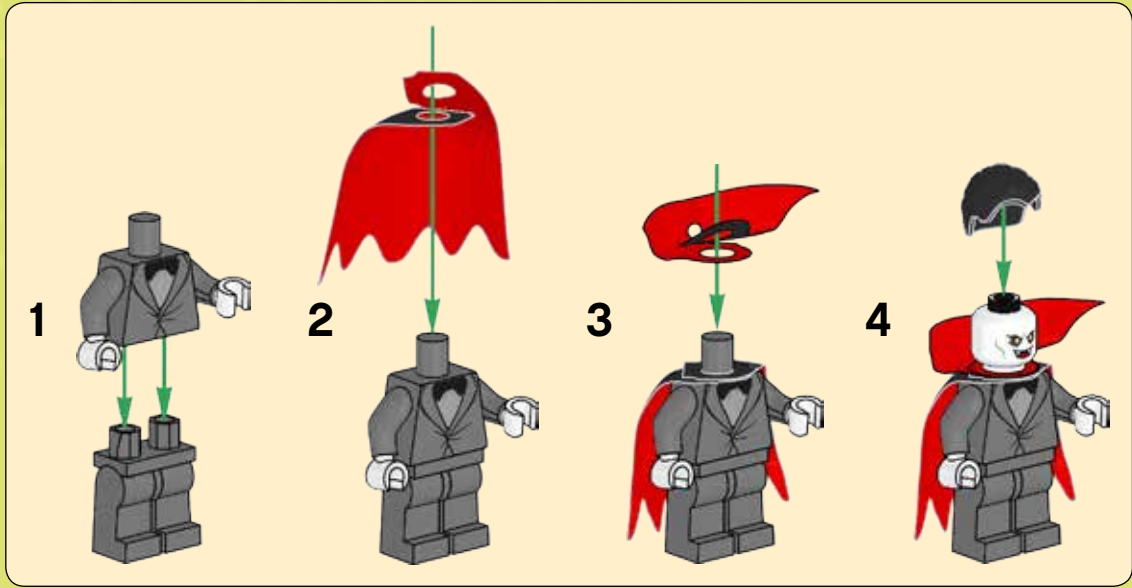
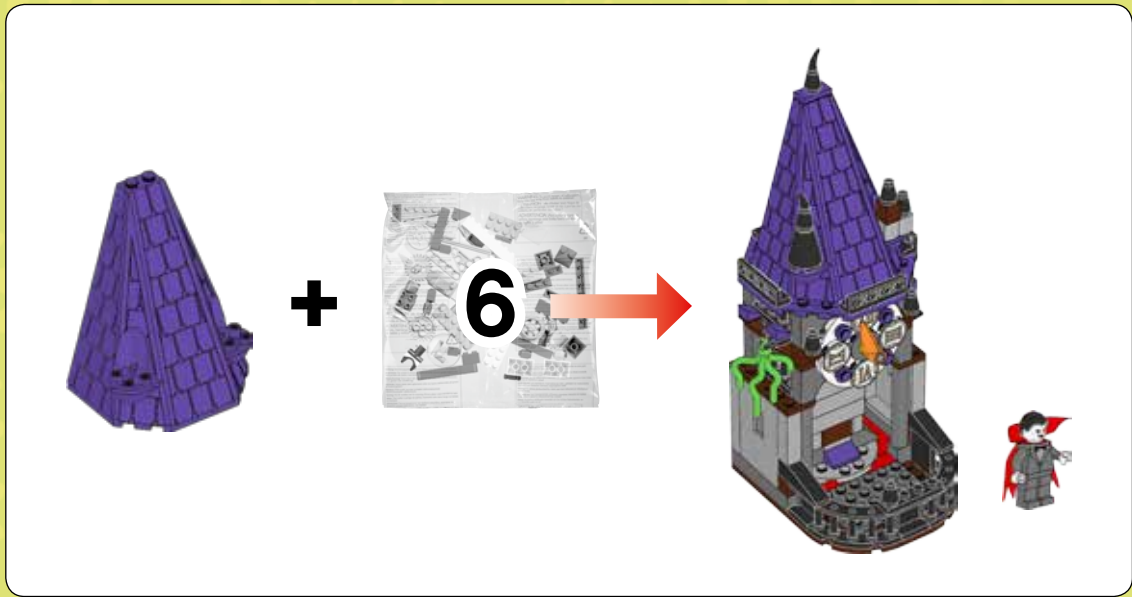

1



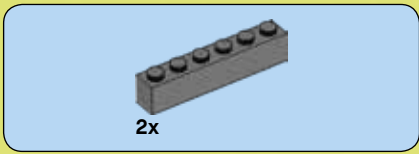

2

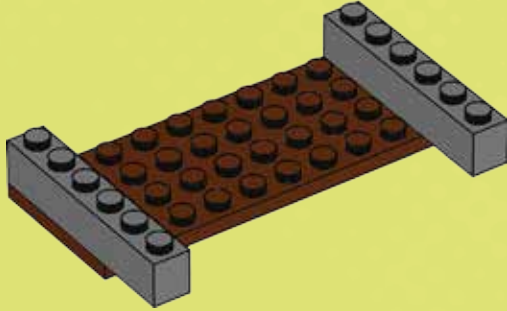

3

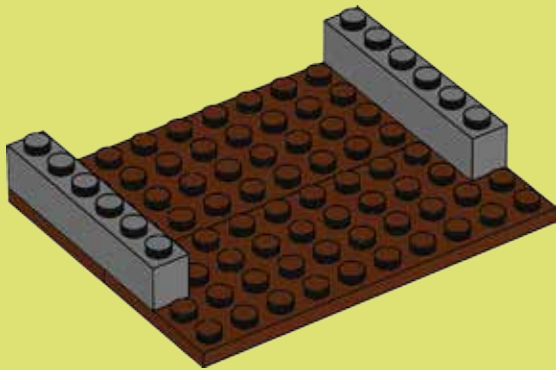

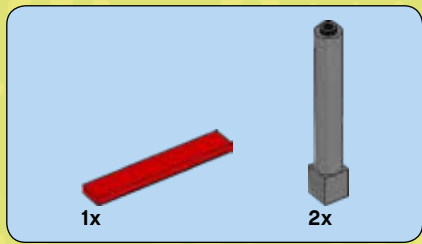

4

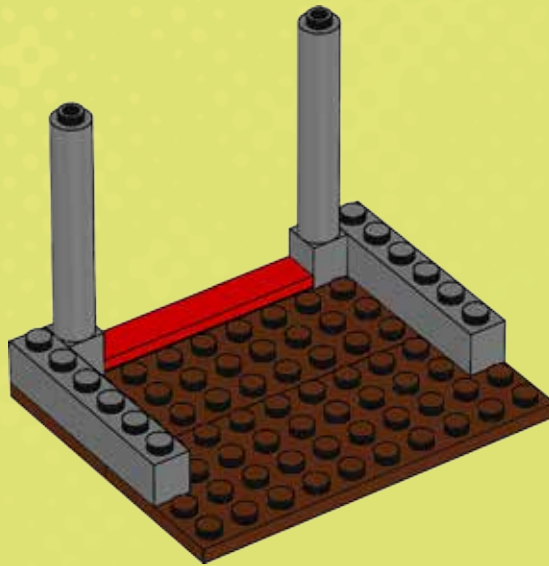

5

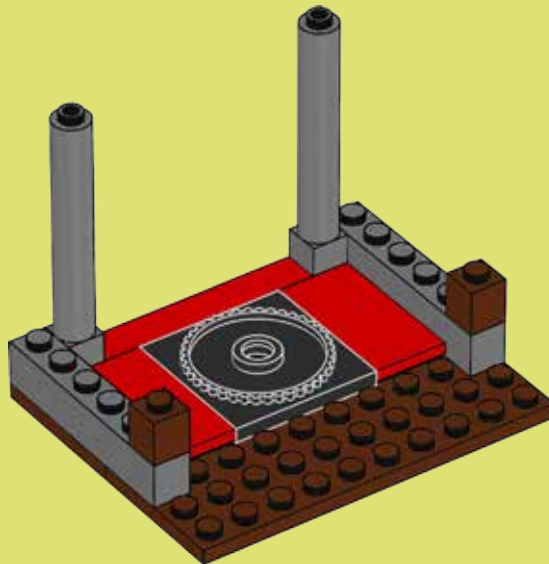



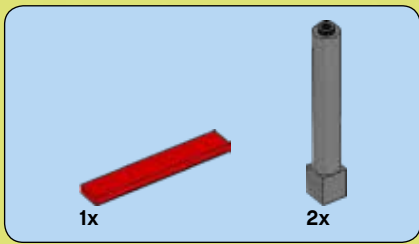

6

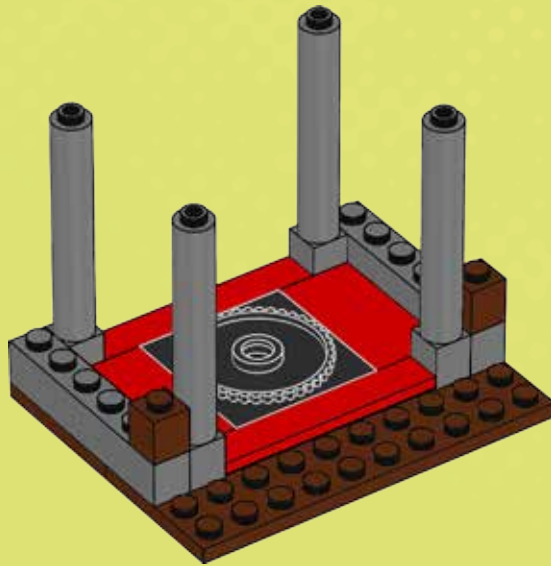

7

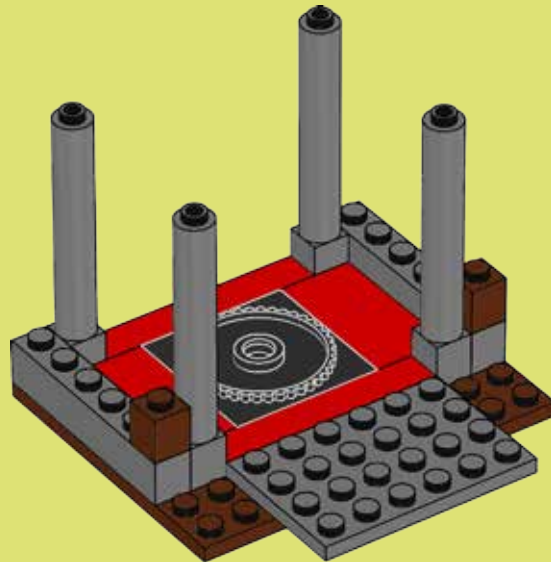



1x

8

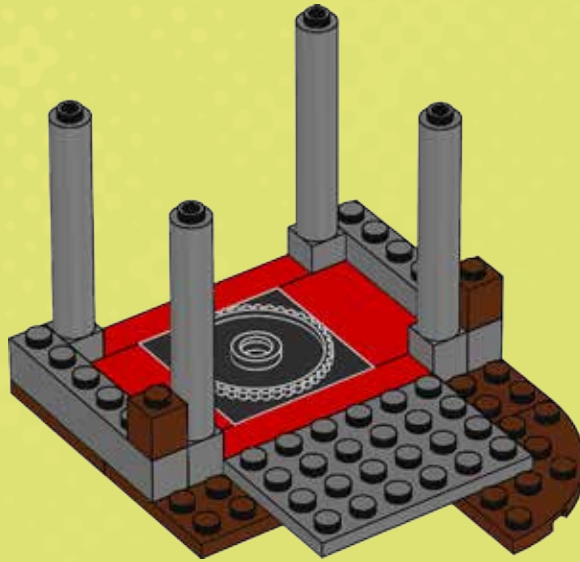

1x



1x

9

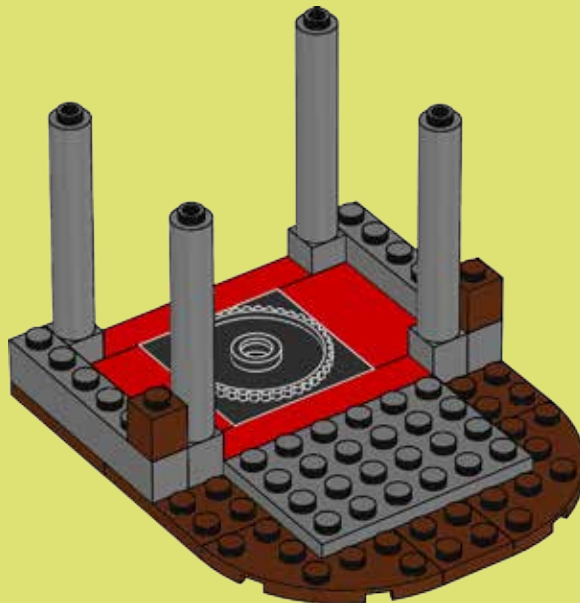



# 10

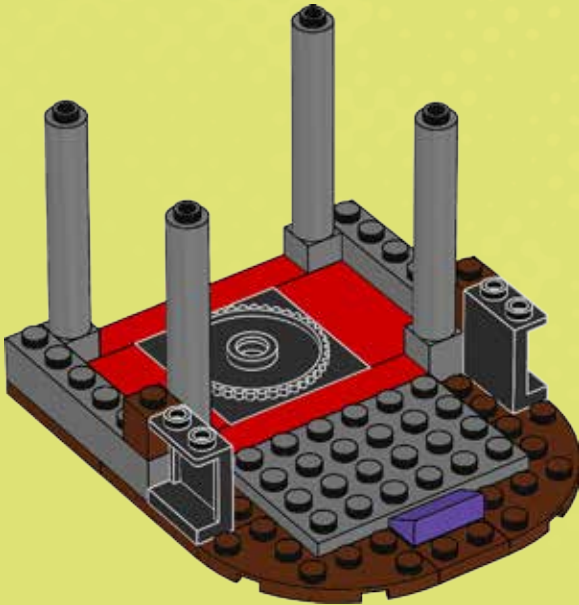

# 11

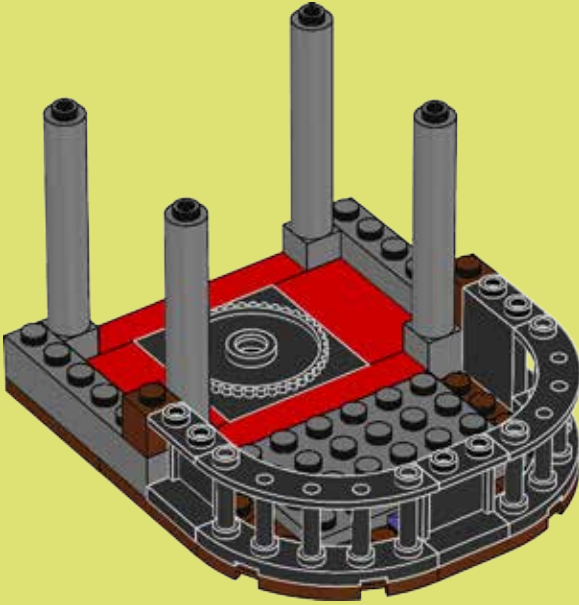



# 12

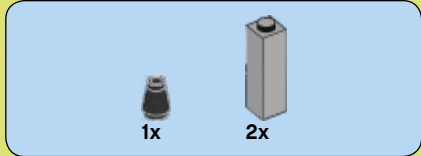
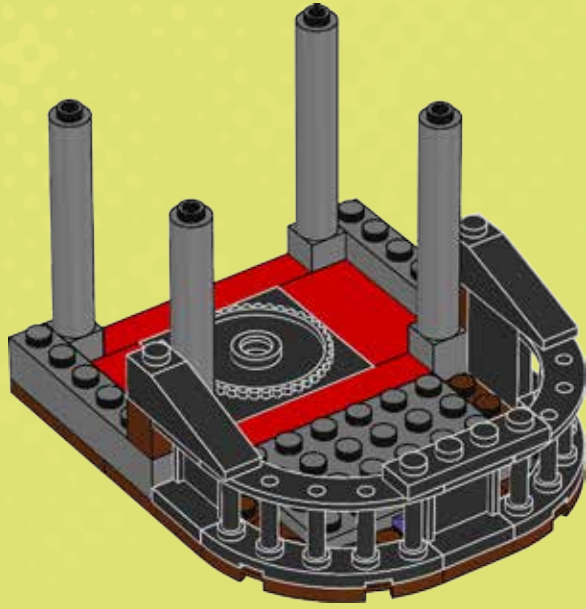

# 13

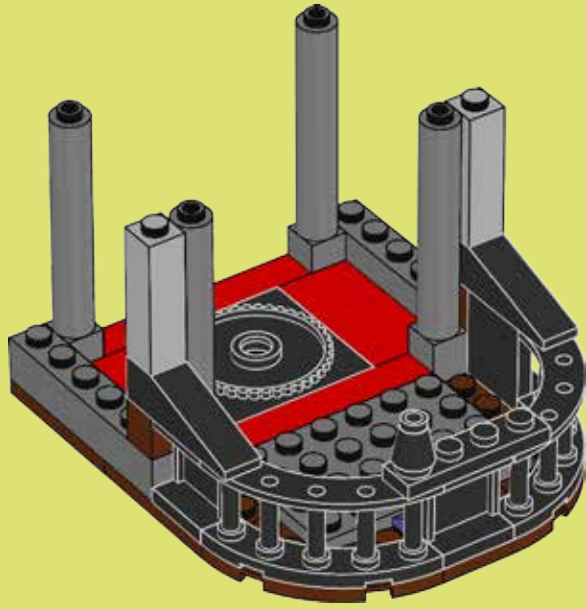



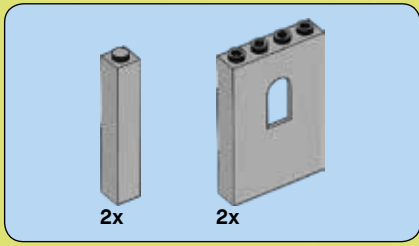

14

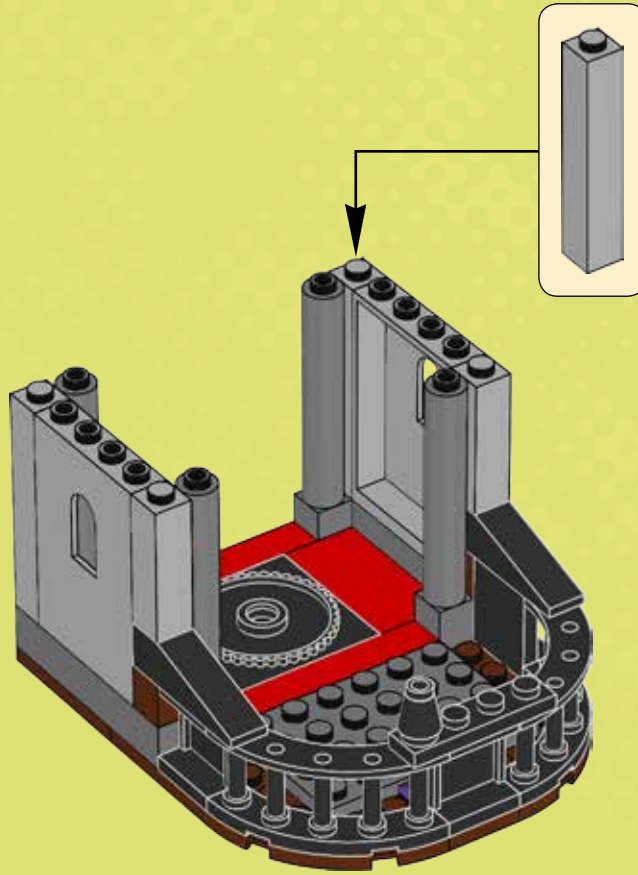

15

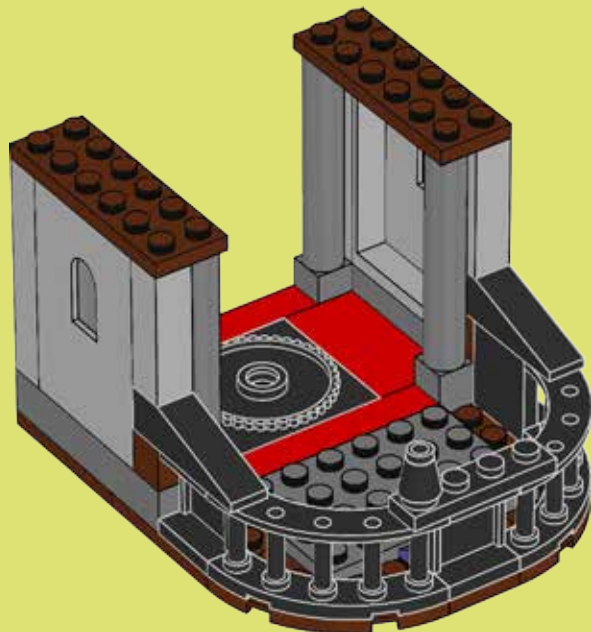

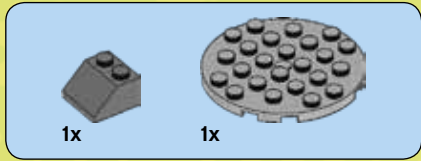
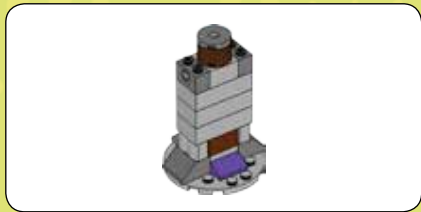

1

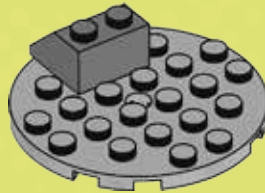

2

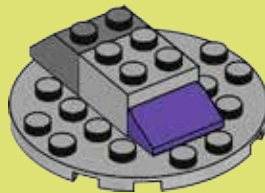

3

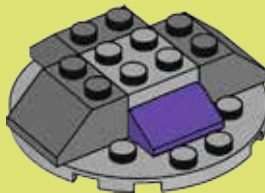

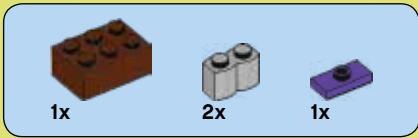

4

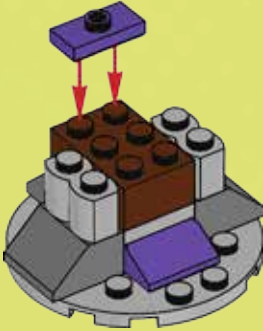

5





3x

6

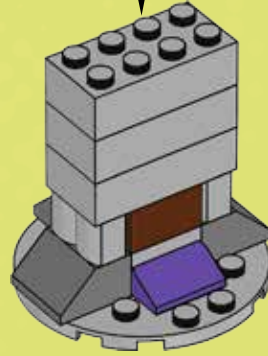
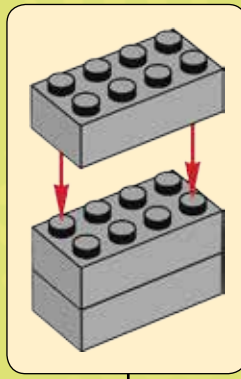

2x

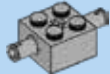

1x

7

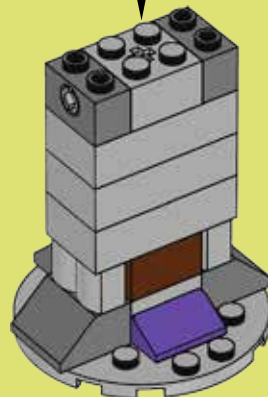
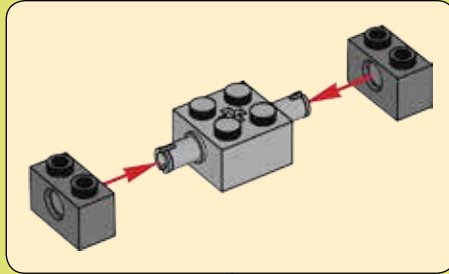





1x



1x

8

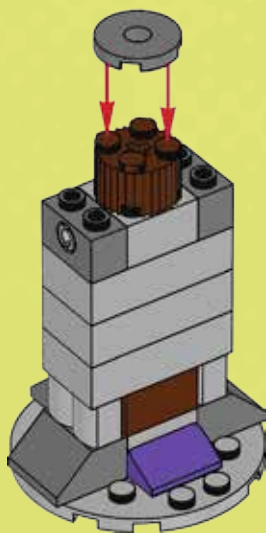

16

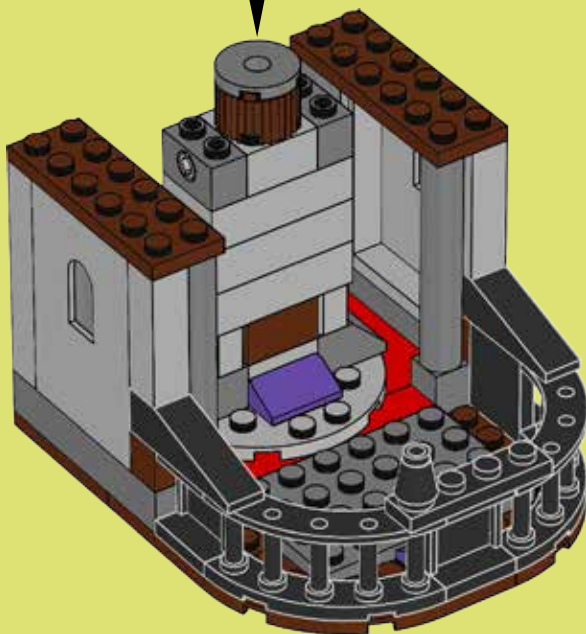





1x

# 19

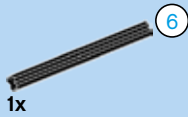
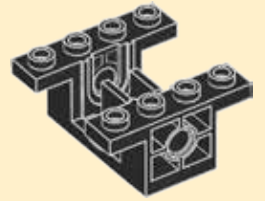
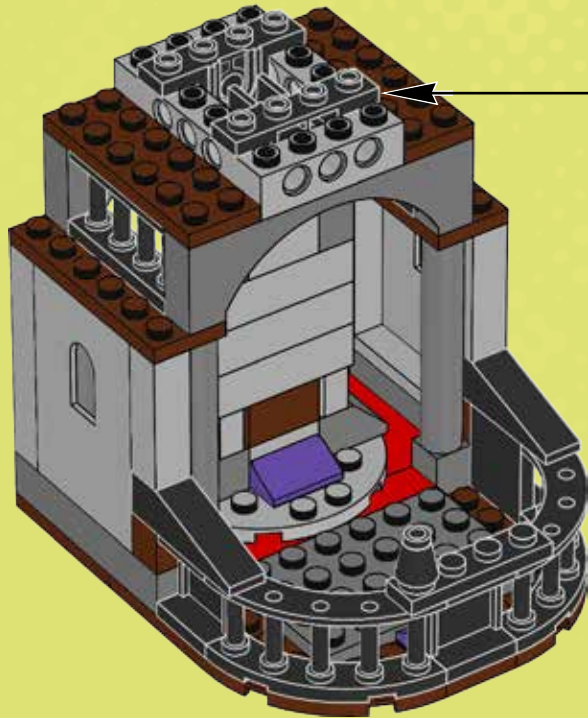

1x

# 20

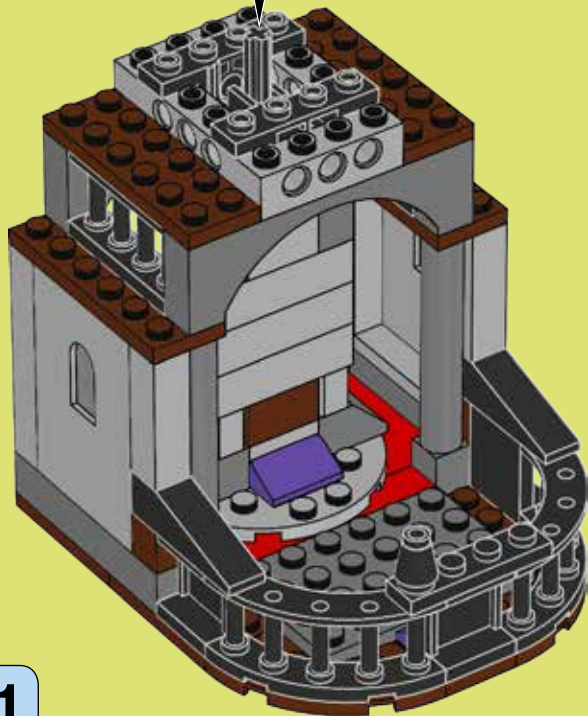

6



6

1:1



2x

# 21

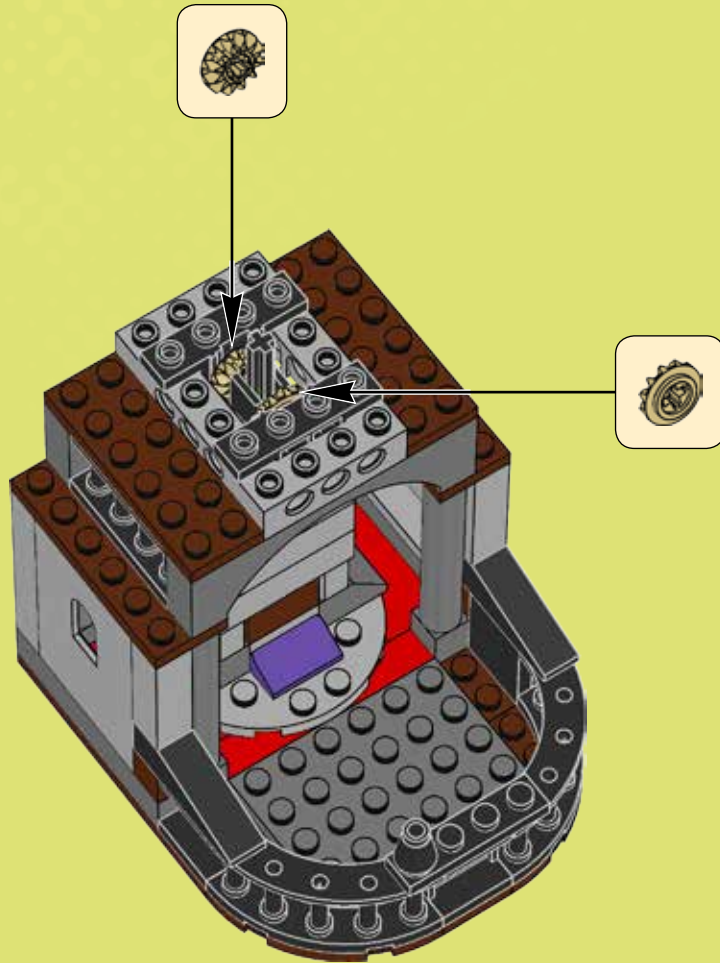





1x

# 22

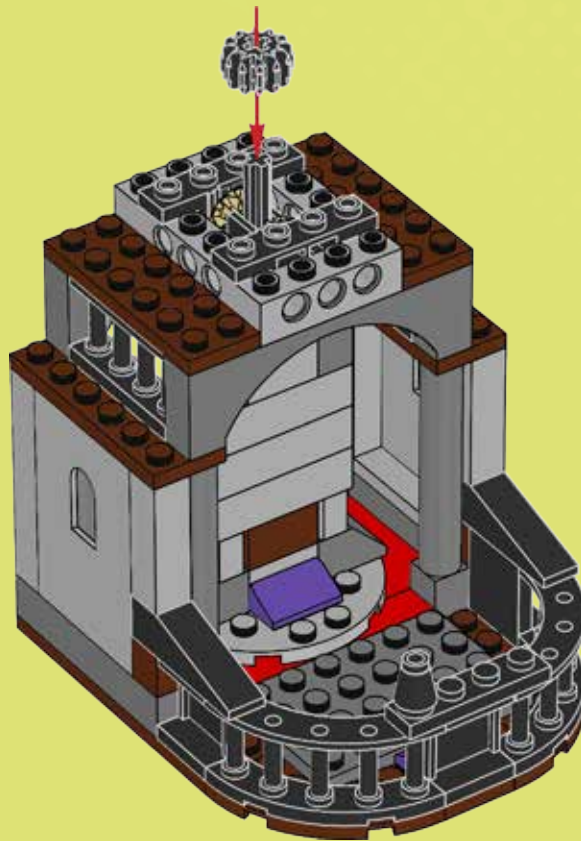

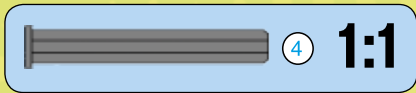

# 23

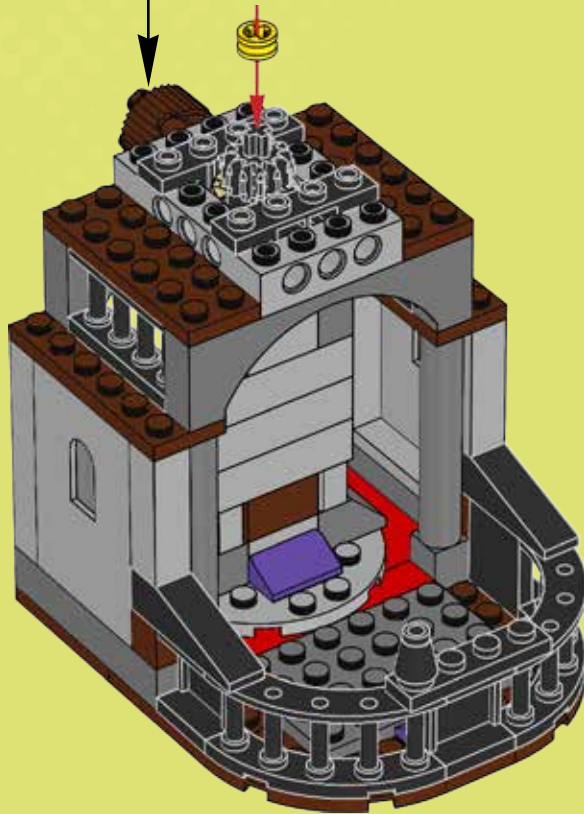
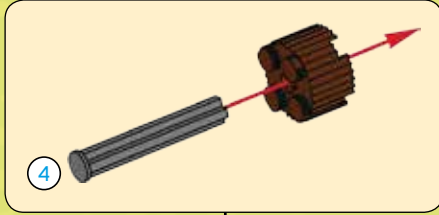



2x

# 24

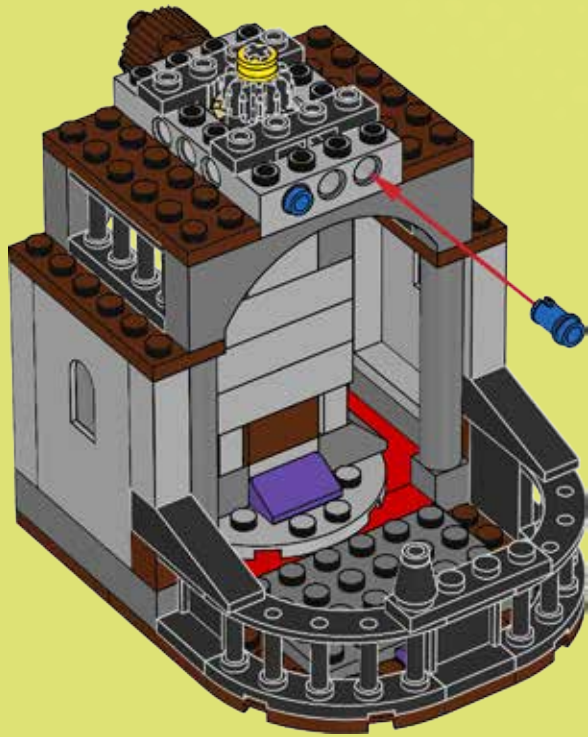

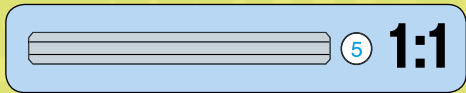
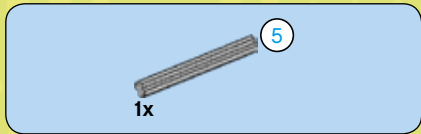

25

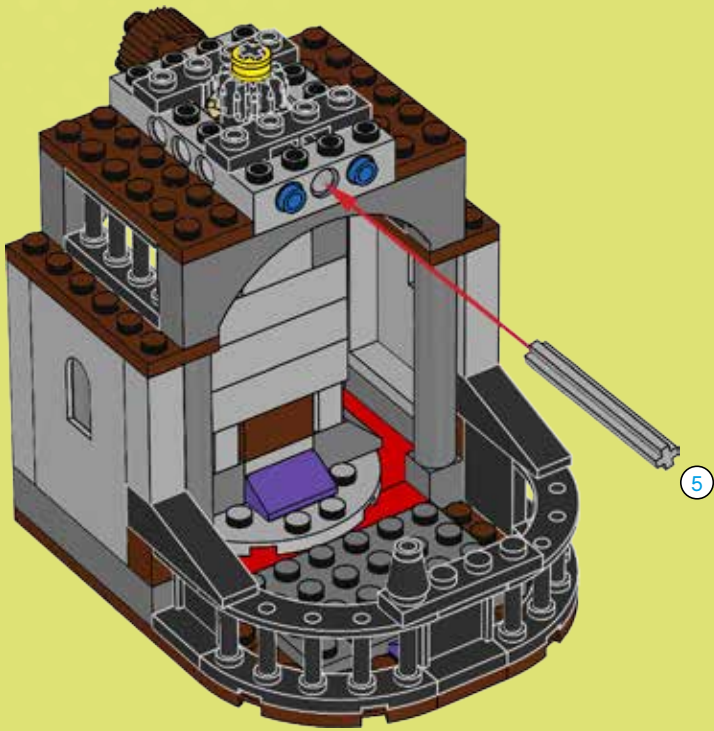





2x

# 26

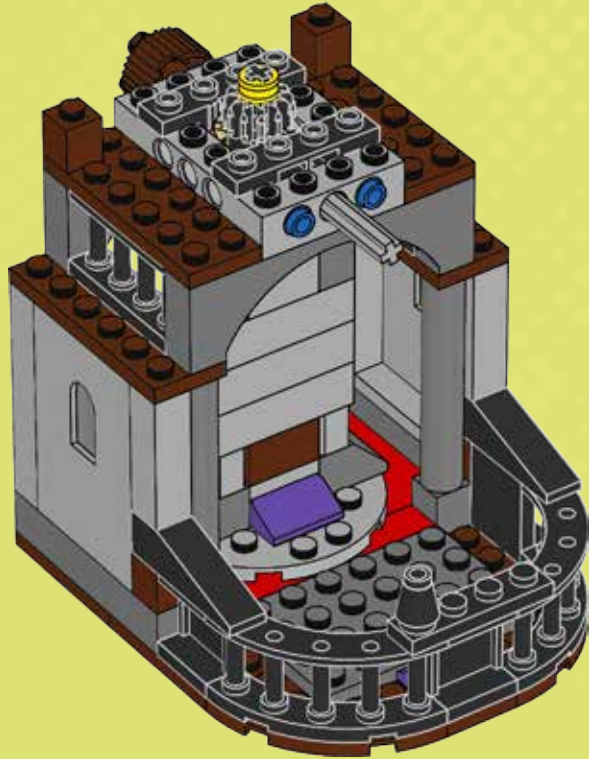

2x



2x

# 27

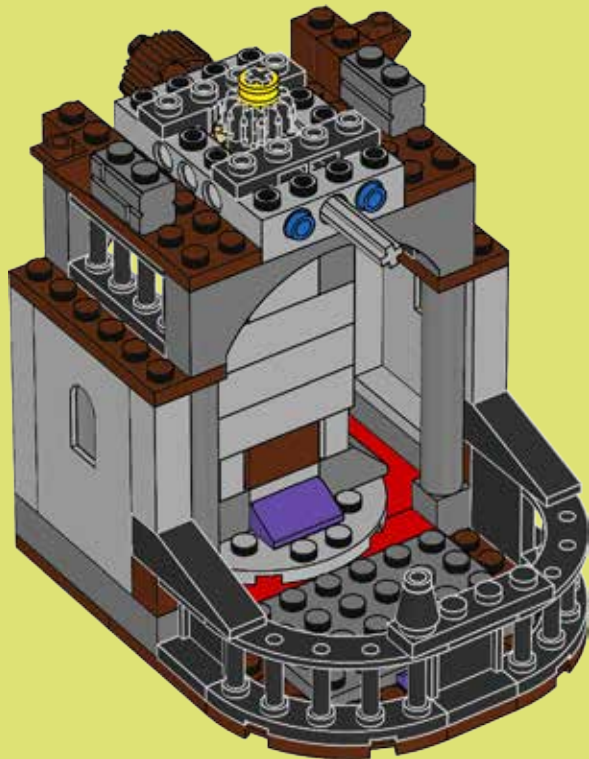



4x

# 28

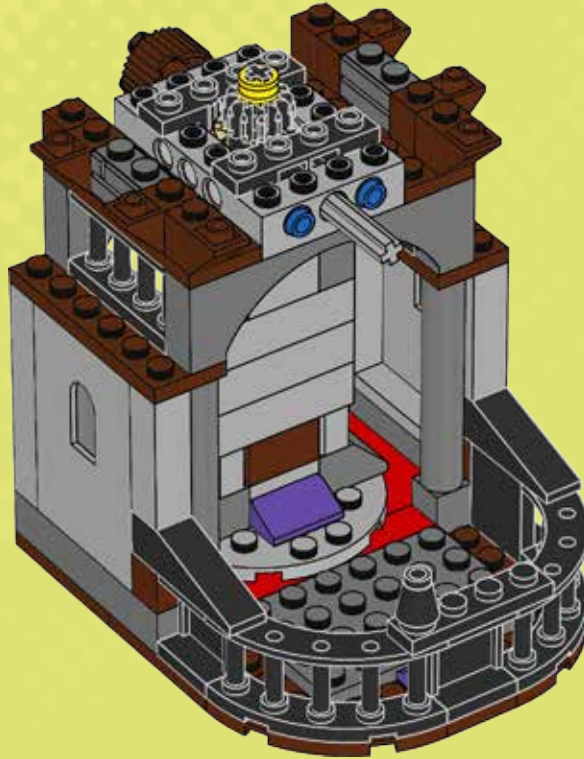

2x



2x

# 29

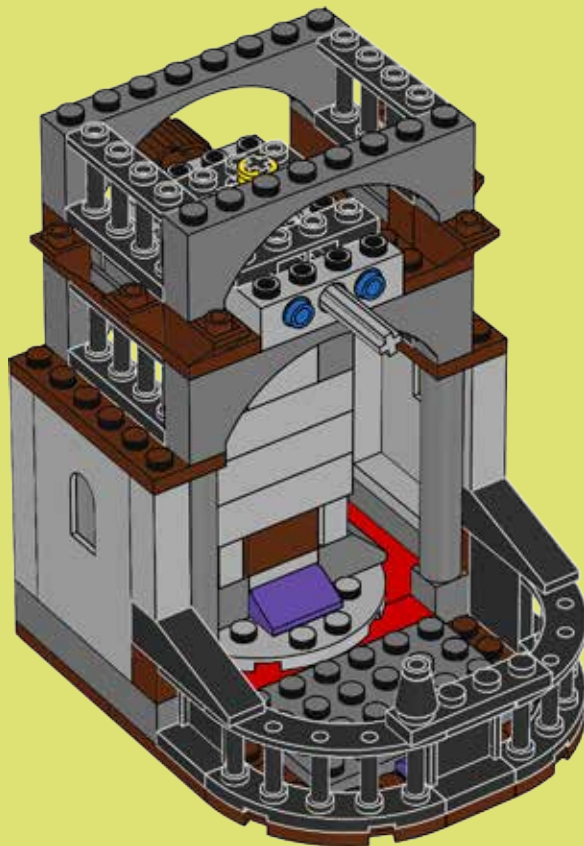



1x

4x

# 30

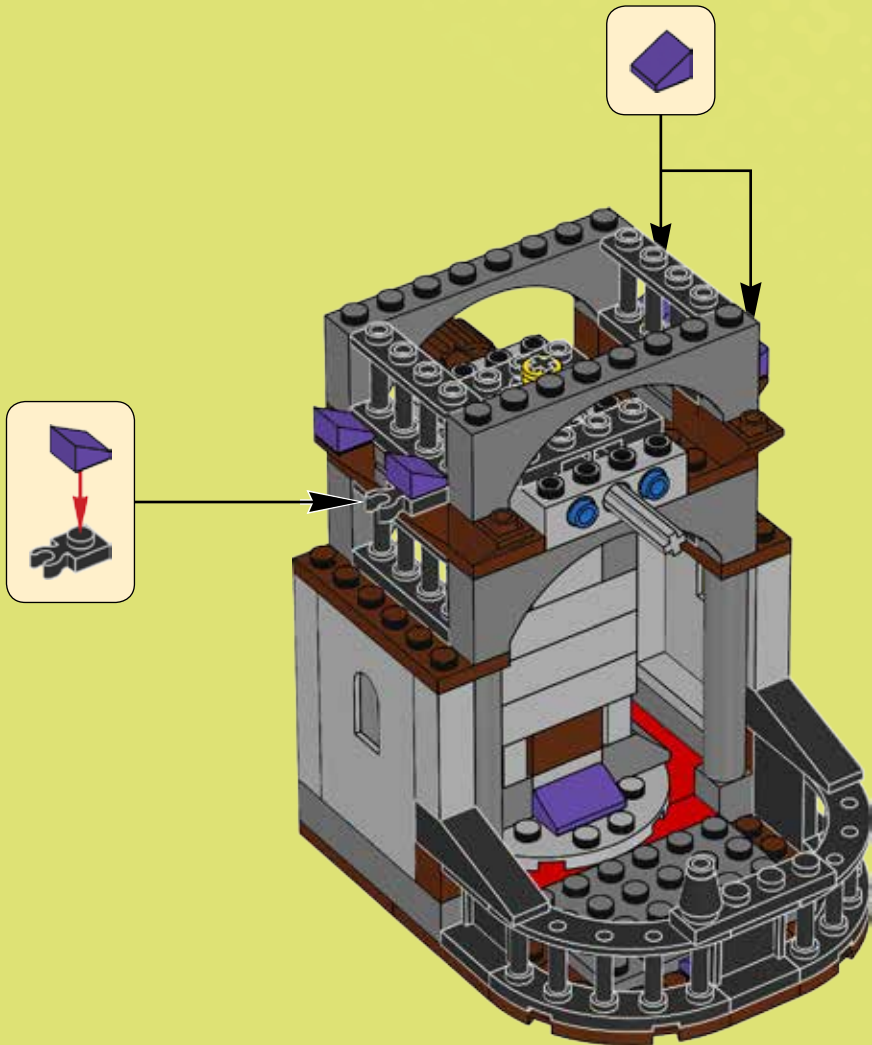

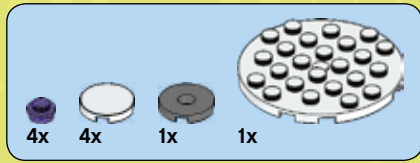

# 31

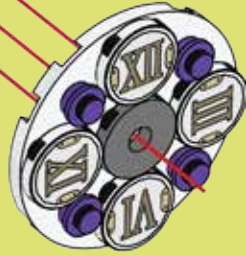
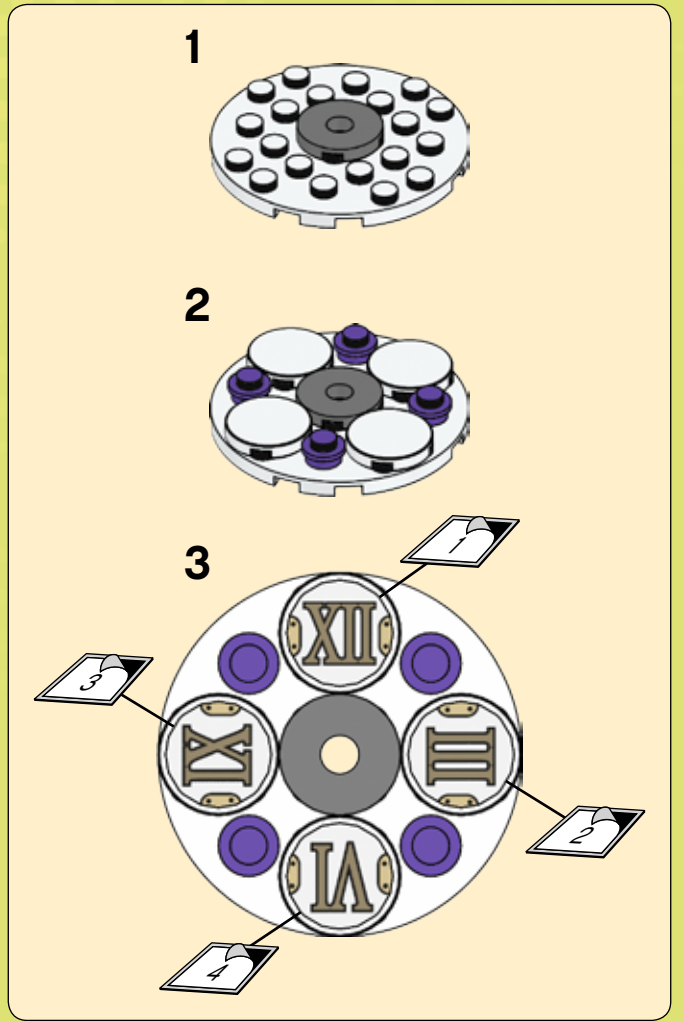
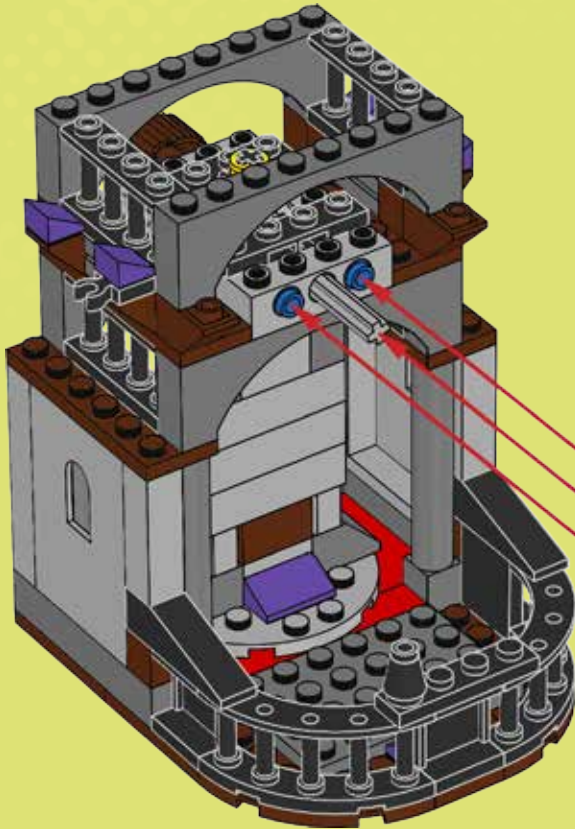





1x



1x

# 32

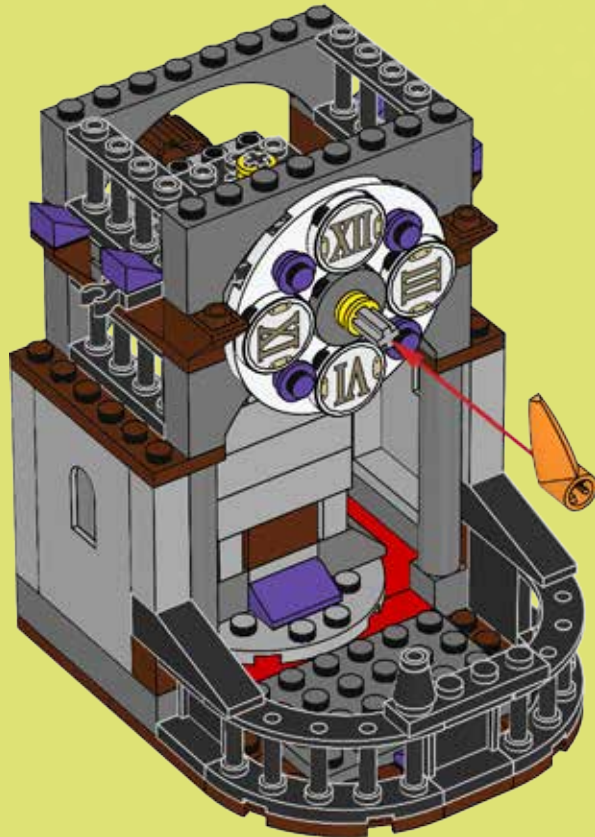

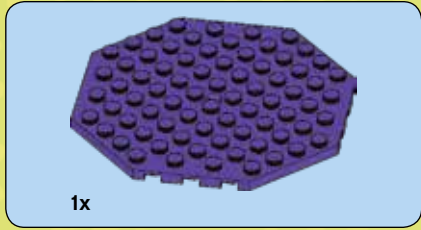

1

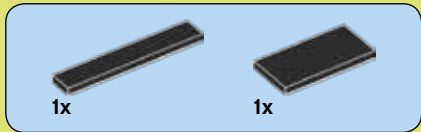
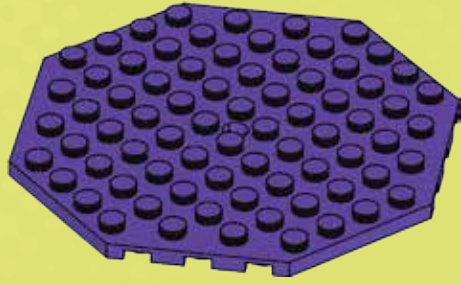

2

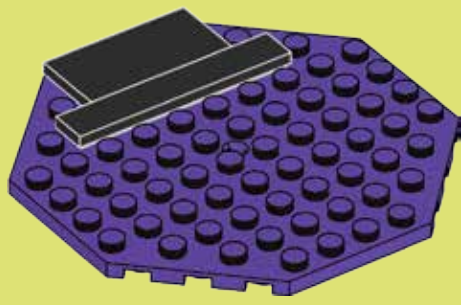

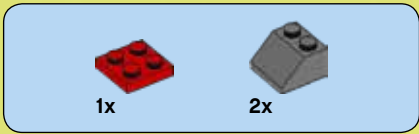

3

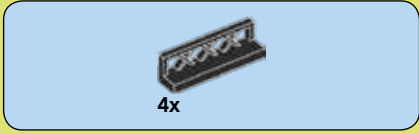
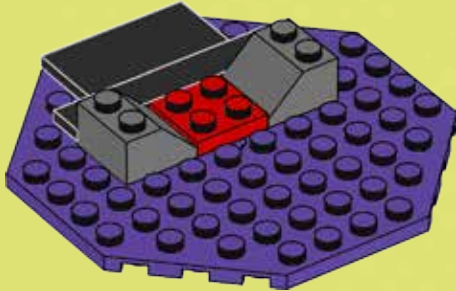

4

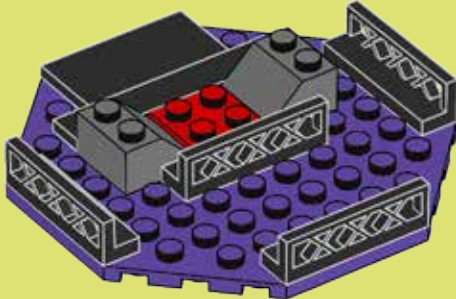

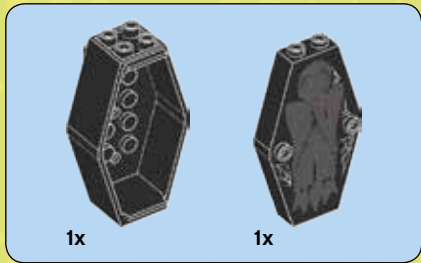

5

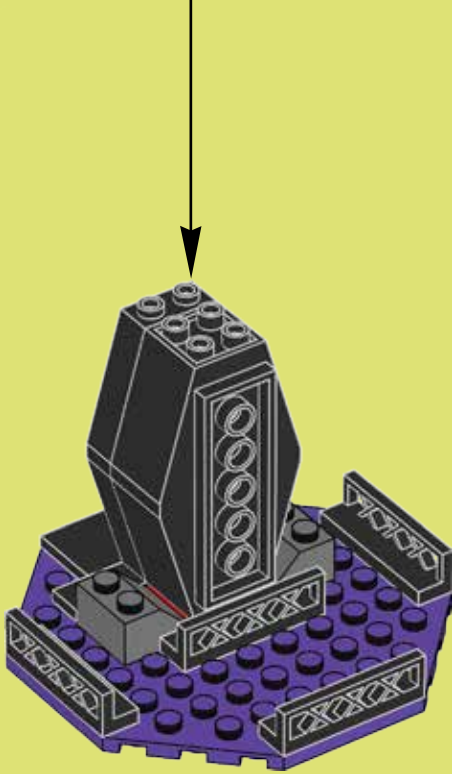
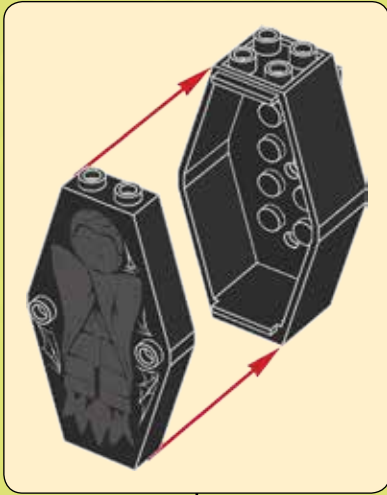



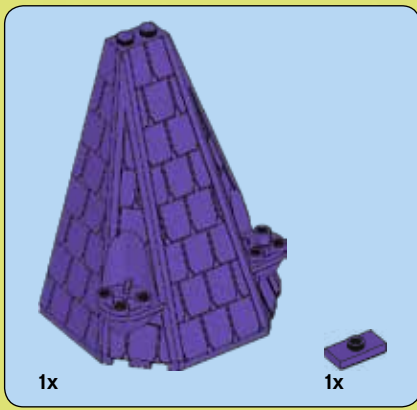

6

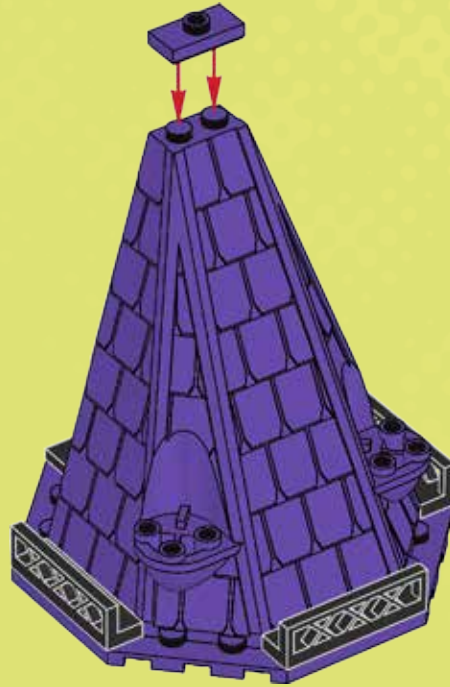

7

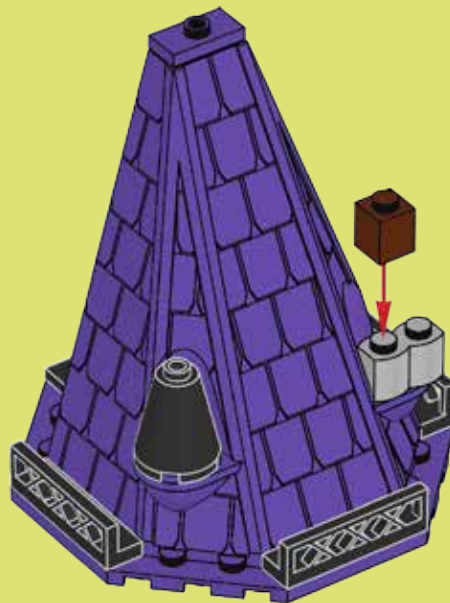



4x

8



2x

9

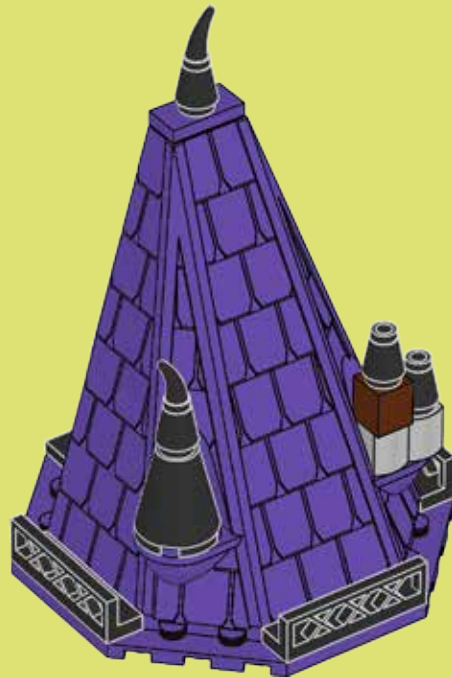

33

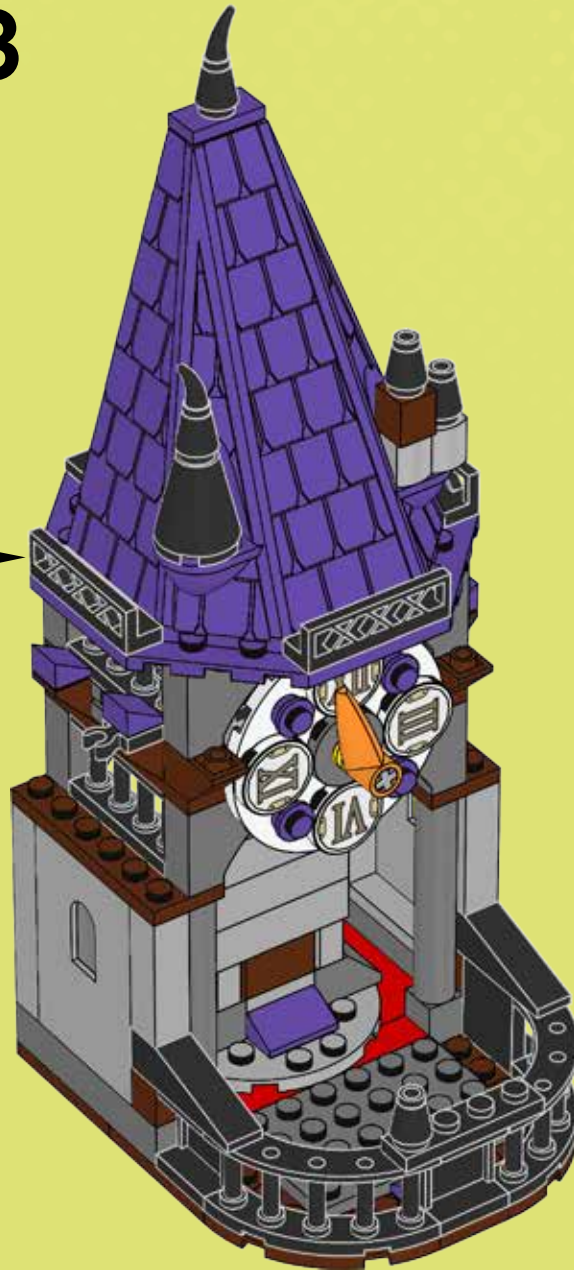



34





35

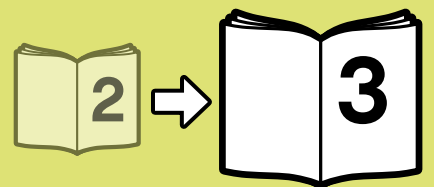





# SCOOBY-DOO!

WE'VE GOT A MYSTERY TO SOLVE  
WIR MÜSSEN EIN GEHEIMNIS LÜFTEN  
NOUS AVONS UN MYSTÈRE À RÉSOUDRE

TENEMOS UN MISTERIO QUE RESOLVER  
TEMOS UM MISTÉRIO PARA RESOLVER  
MÁIS VAN EGY MEGOLDÁSRA VÁRÓ REJTÉLYÜNK

75900



75901



75902



75903



75904



[LEGO.COM/scoobydoo](http://LEGO.COM/scoobydoo)



- 3x 300401
- 1x 300301
- 1x 6123703
- 3x 306801
- 3x 346001
- 4x 6044691
- 1x 6109817
- 2x 623101
- 1x 434601
- 1x 4261470
- 1x 434501
- 1x 4619665
- 1x 9327
- 1x 6009516
- 1x 6122261
- 1x 4651445
- 1x 4600294
- 2x 4143005
- 1x 4523145
- 1x 4113233
- 1x 6115248
- 1x 6122533
- 2x 4565452
- 1x 302221
- 2x 4560179
- 2x 4113858
- 2x 614121
- 2x 4278275
- 1x 6122968
- 1x 4540552
- 1x 4520952
- 1x 368021
- 1x 6119513
- 1x 6119515
- 1x 6012466
- 1x 4541496
- 1x 4233484
- 1x 302224
- 4x 6047218
- 4x 4239601
- 1x 6081988
- 18x 4529236
- 2x 6092664
- 1x 4500978
- 2x 4515362
- 2x 6053077
- 6x 306926
- 15x 302326
- 2x 302226
- 1x 362326
- 5x 371026
- 1x 4560182
- 1x 302026
- 4x 366626
- 7x 663626
- 1x 6066102
- 2x 4550017
- 5x 4107761
- 4x 614126
- 1x 474026
- 1x 4180087
- 1x 4227684
- 3x 4593678
- 1x 4521681
- 2x 4535834
- 1x 6123711
- 1x 6121348
- 1x 4106552
- 1x 4177431
- 8x 346026
- 1x 244526
- 8x 6066113
- 8x 4187209
- 2x 4294570
- 1x 6122408
- 1x 6122463
- 1x 4654944
- 1x 452926
- 1x 6020192
- 9x 4568385
- 1x 4106513
- 1x 4617848
- 2x 6064174
- 1x 393826
- 1x 4517986
- 1x 4500902
- 1x 6055308
- 19x 4121715
- 1x 370526
- 1x 370626
- 1x 6122411
- 1x 4617224
- 2x 4613958
- 1x 6021363
- 2x 6014026
- 2x 4521948
- 2x 4616581
- 1x 4633693
- 1x 6121349
- 1x 6119136
- 1x 6117569
- 1x 6117589
- 1x 6092599
- 2x 4157103
- 1x 6122416
- 1x 6122725
- 2x 6122207
- 1x 4281515
- 1x 4654448

4

6



- 2x 6047426
- 1x 6021539
- 3x 306928
- 1x 302328
- 2x 4565321
- 1x 371028
- 2x 243128
- 1x 4296081
- 2x 4556159
- 2x 4521931
- 2x 4114348
- 3x 6059027
- 1x 6092601
- 3x 4179825
- 4x 4581079
- 2x 4255624
- 1x 4569217
- 1x 4505066
- 2x 4294148

- 4x 4216581
- 8x 6084573
- 5x 4636170
- 2x 4211189
- 3x 4211190
- 6x 4211194
- 3x 4211186
- 1x 4211204
- 2x 4221590
- 5x 4243838
- 7x 4211247
- 4x 4211211
- 2x 4217848
- 3x 4223683
- 4x 4223729
- 4x 4225715
- 1x 4225700

- 30x 4211242
- 3x 4226966
- 9x 4211180
- 1x 4216668
- 2x 4225469
- 2x 4211183
- 4x 6036503
- 1x 4504376
- 1x 4270470
- 6x 4211222
- 1x 6121737
- 1x 4598713
- 1x 4211202
- 2x 4211197
- 4x 6055086
- 2x 6044725
- 3x 6096379

- 3x 4211150
- 1x 4211151
- 2x 4271949
- 1x 4211257
- 1x 4211152
- 13x 6058084
- 6x 4595814
- 2x 6061702
- 2x 4211362
- 42x 4550325
- 2x 4211564
- 8x 4211387
- 4x 4211650
- 7x 4211394
- 5x 4211385
- 10x 4211393
- 1x 4211392

- 12x 4558953
- 2x 4533772
- 1x 4211752
- 1x 4211716
- 2x 6007894
- 2x 6106189
- 1x 6063898
- 1x 4211395
- 1x 4211837
- 1x 6043656
- 4x 4211376
- 1x 6015349
- 2x 4537056
- 4x 4527174
- 1x 4211503
- 1x 4610112



1x 4512743  
 2x 4590443  
 1x 4540203  
 1x 4211469  
 1x 4563045  
 1x 4211758  
 1x 4211807  
 1x 4211815  
 1x 4211639  
 1x 4164022  
 2x 4212446  
 2x 6023954  
 1x 4164037  
 1x 4537936  
 9x 4183133  
 1x 6117683  
 2x 4619513  
 2x 4625036  
 1x 6070379  
 1x 6070380

23x 6000311  
 22x 4211104  
 1x 4211085  
 2x 4211100  
 2x 4210875  
 2x 4211128  
 1x 4210725  
 6x 4180811  
 6x 4210639  
 23x 4211111  
 8x 4210917  
 5x 4211054  
 5x 6079721  
 1x 6092649  
 2x 4210848  
 1x 4211052  
 2x 4211001  
 3x 4211065

1x 4243831  
 1x 4211115  
 3x 4579354  
 1x 6039479  
 1x 6039482  
 2x 6055313  
 2x 4222693  
 1x 6122280  
 2x 4516546  
 4x 6083620  
 2x 6109820  
 1x 6109819  
 4x 6109812  
 1x 6029584  
 1x 6056448

15x 4567509  
 7x 4566607  
 6x 6022070  
 25x 6109814  
 2x 6055877  
 2x 4655695  
 6x 6092604  
 4x 4566522  
 1x 6122746  
 1x 6122736  
 1x 6123944  
 1x 6122731  
 1x 6122133  
 1x 6004714  
 1x 6022033  
 3x 6051823  
 1x 6005030

2x 4244362  
 2x 3005740  
 13x 4536998  
 6x 6024020  
 2x 6000740  
 3x 6010737  
 1x 6054554  
 1x 4594686  
 1x 4504229  
 1x 4567332  
 1x 3005744  
 2x 6039180  
 1x 6055651

**Customer Service**  
 Kundenservice  
 Service Consommateurs  
 Servicio Al Consumidor  
 LEGO.com/service or dial

: 00800 5346 5555  
 : 1-800-422-5346

*More spooky fun at / Noch mehr Gruselspaß auf /  
Plus d'amusement effrayant sur / Mäs diversión tenebrosa en /  
Mais diversão arrepiante em / További rémisztő móka itt*  
**LEGO.com/scoobydoo**



**SCOOBY-DOO!**

LEGO and the LEGO logo are trademarks of the LEGO Group. ©2015 The LEGO Group. 6132710

TM & © Hanna-Barbera.  
WB SHIELD: TM & © Warner Bros. Entertainment Inc.  
(s15)

Apple, the Apple logo, iPad, iPhone and iPod touch are trademarks of Apple Inc.  
Google Play is a trademark of Google Inc.







# SCOOPY-DOO!

75904



 [LEGO.com/scoobydoo](http://LEGO.com/scoobydoo)



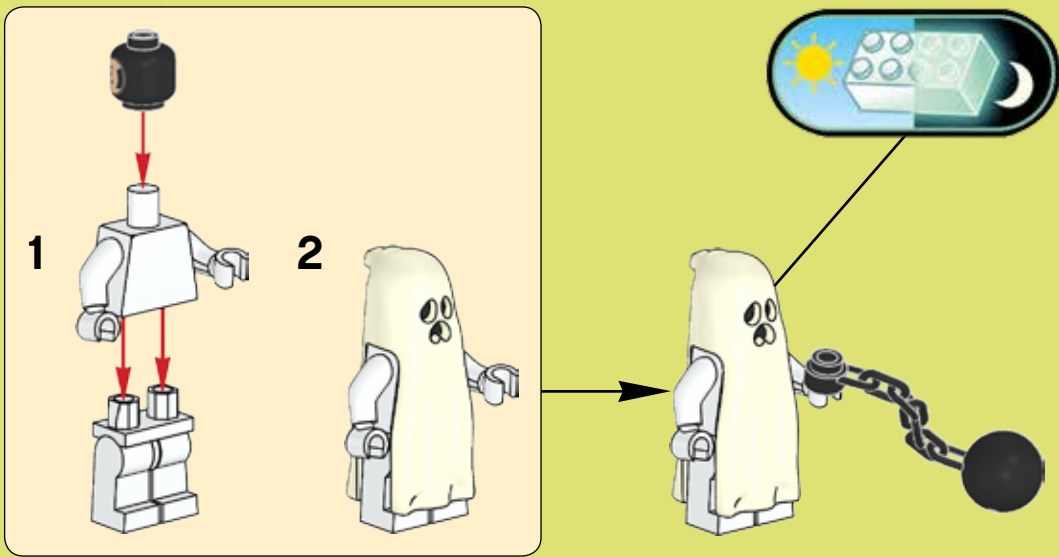
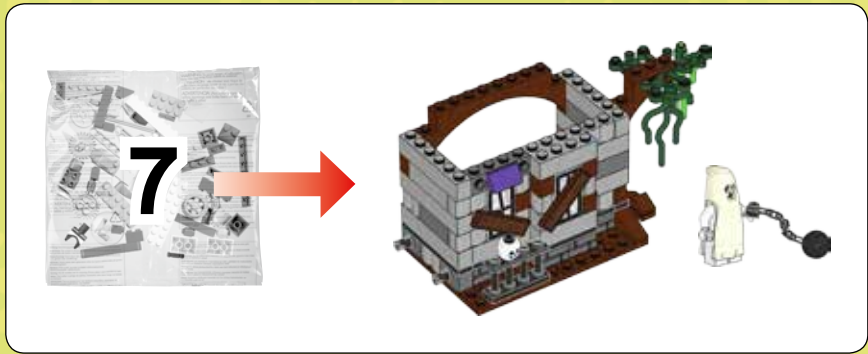





1

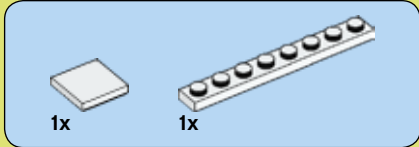

2

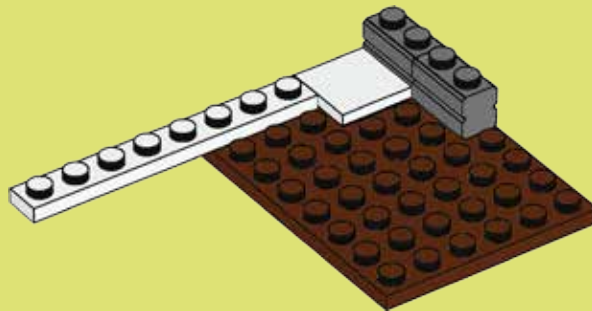

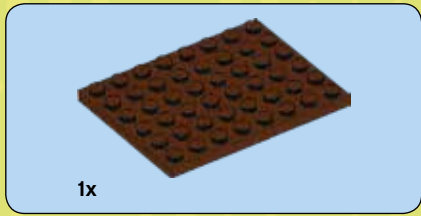

3

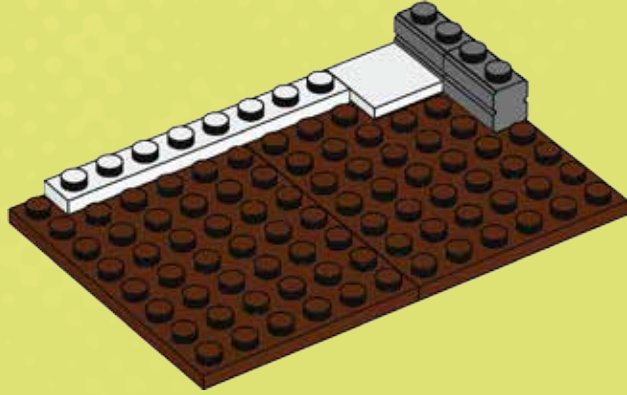

4

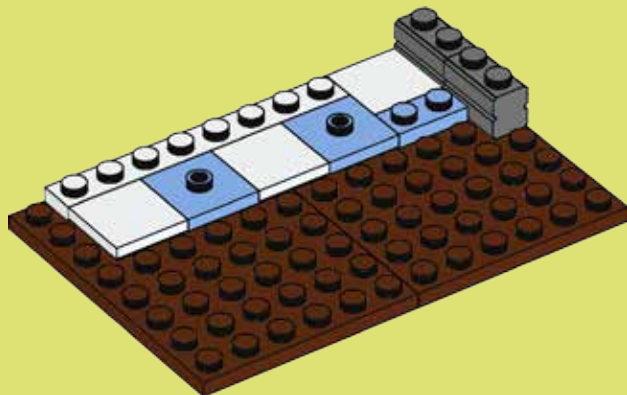

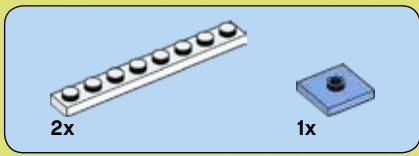

5

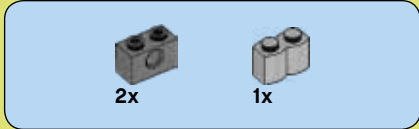
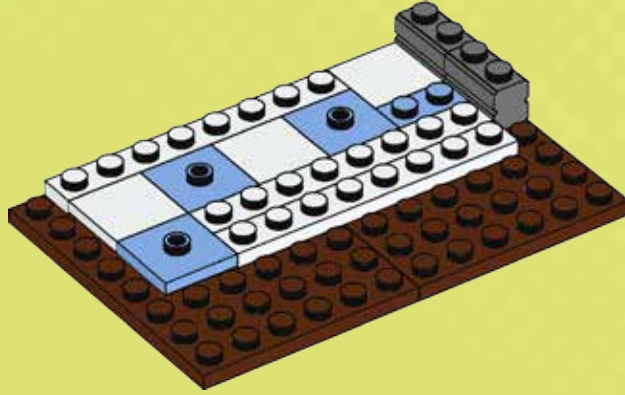

6

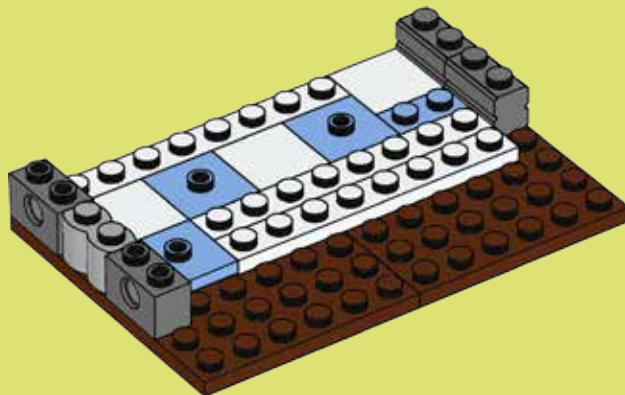

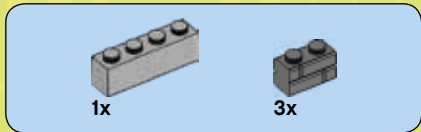

7

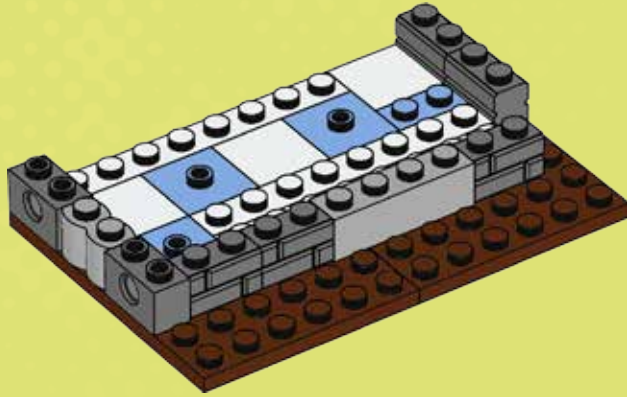

8

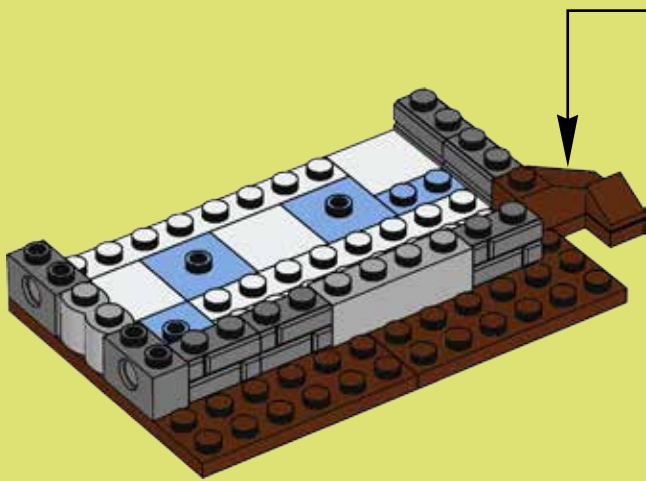
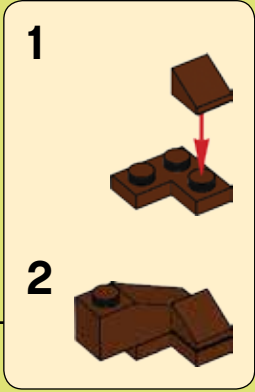





9

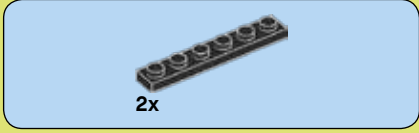
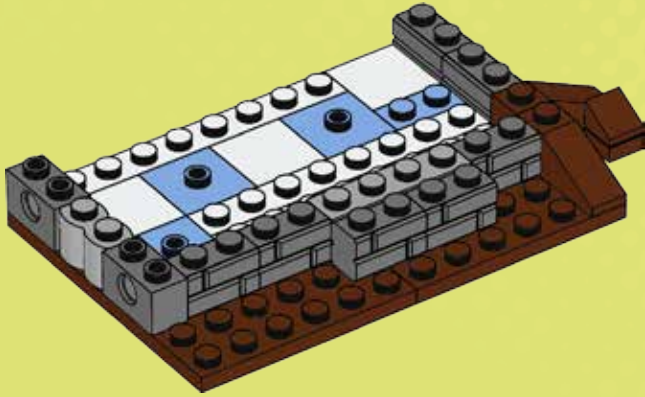

10

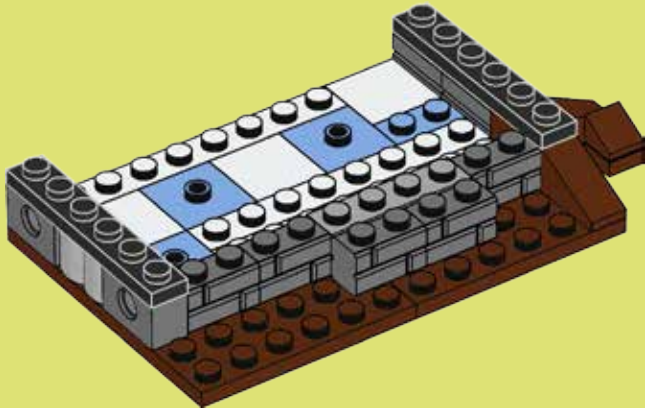

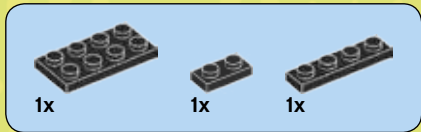

# 11

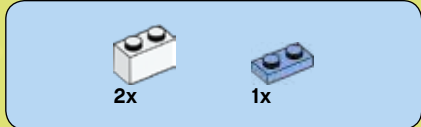
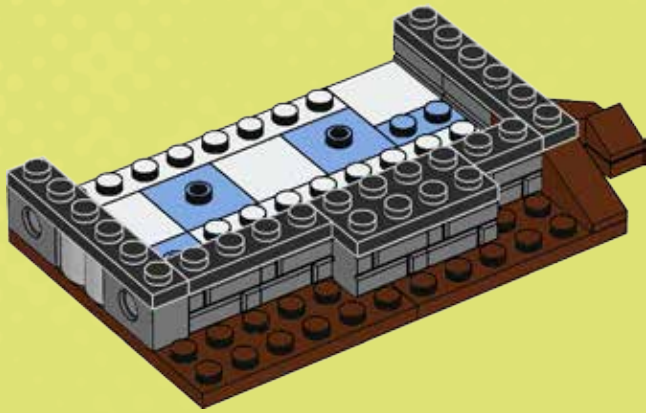

# 12

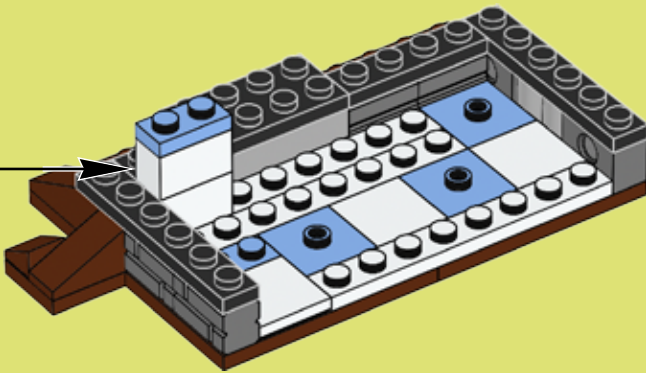
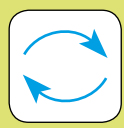
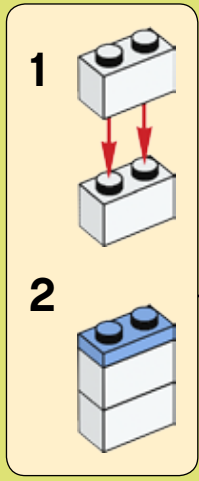

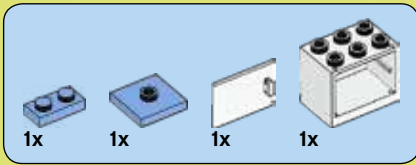

# 13

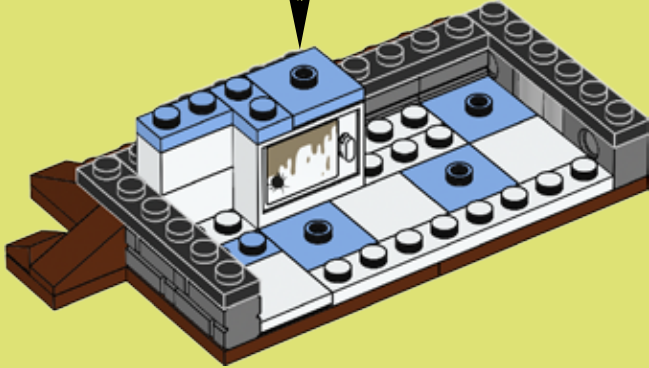
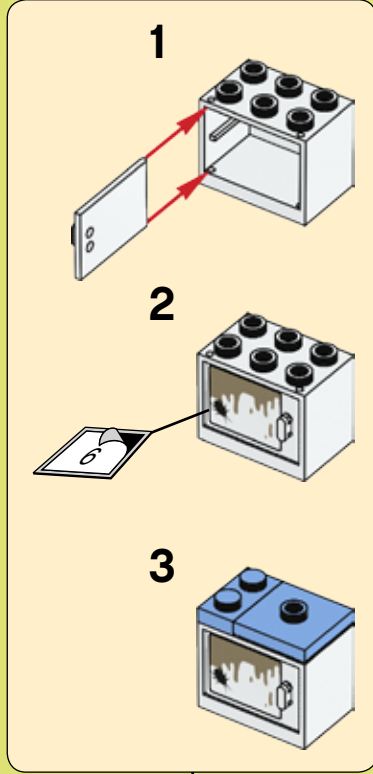

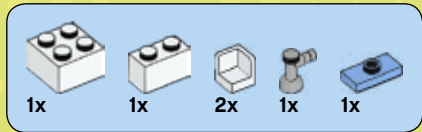

# 14

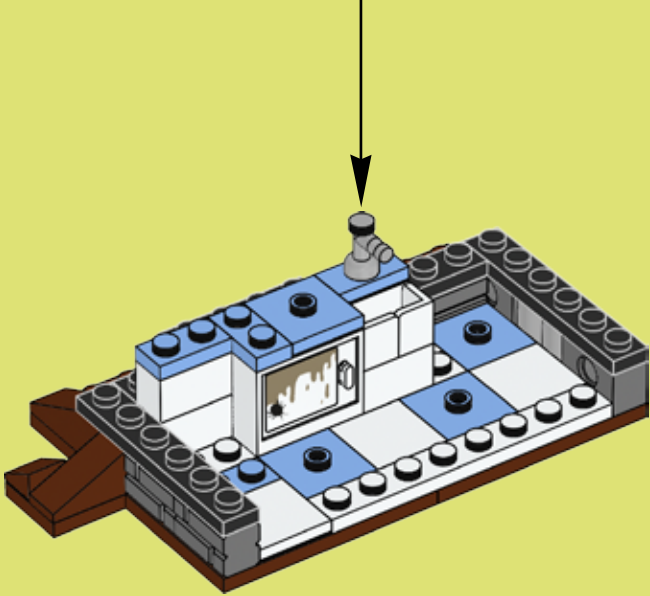
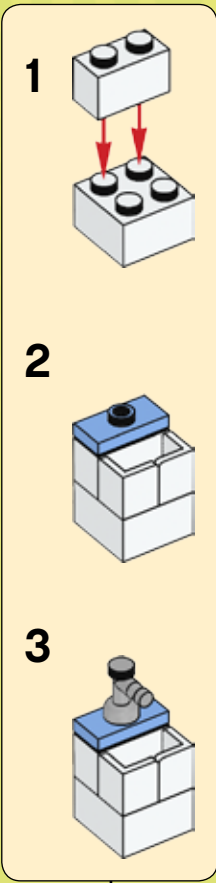



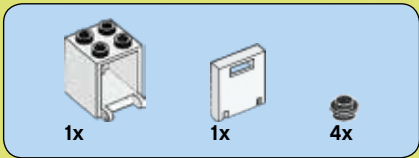

# 15

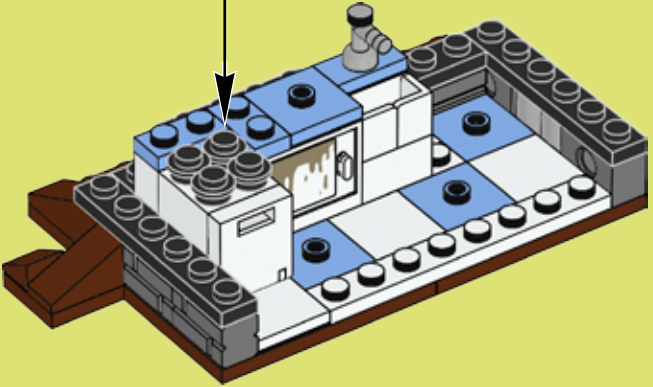
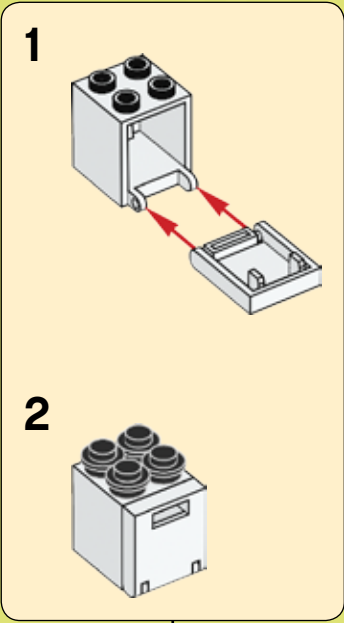

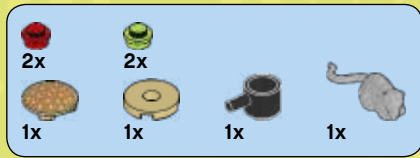

# 16

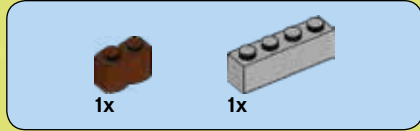

# 17

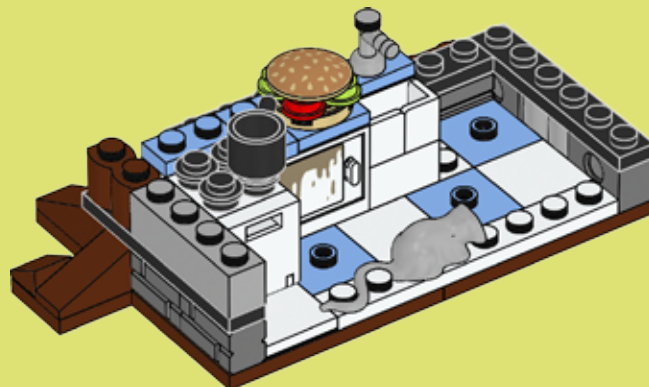

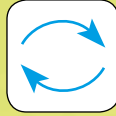
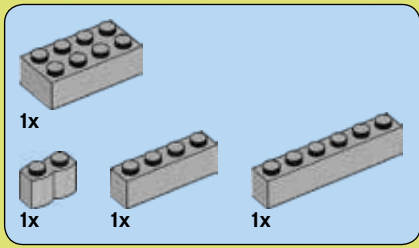

18

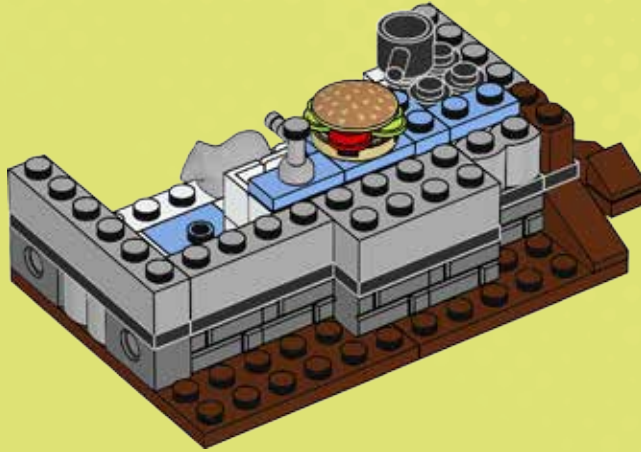

19

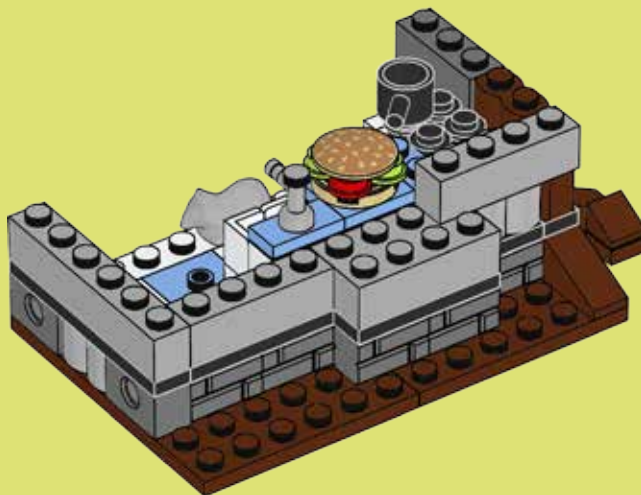



1x



1x

# 20

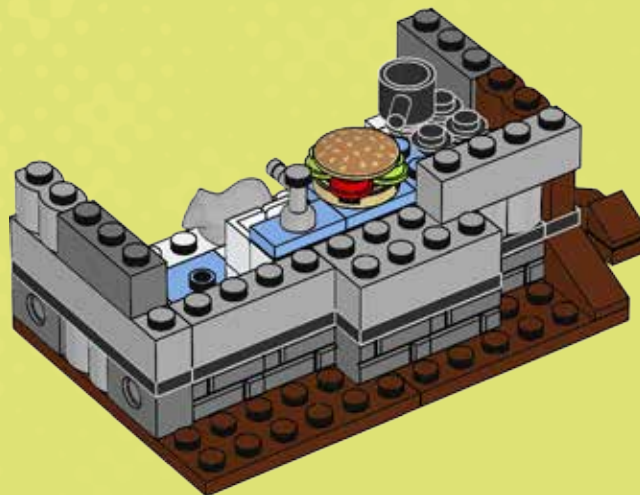

2x



1x

# 21

1



2

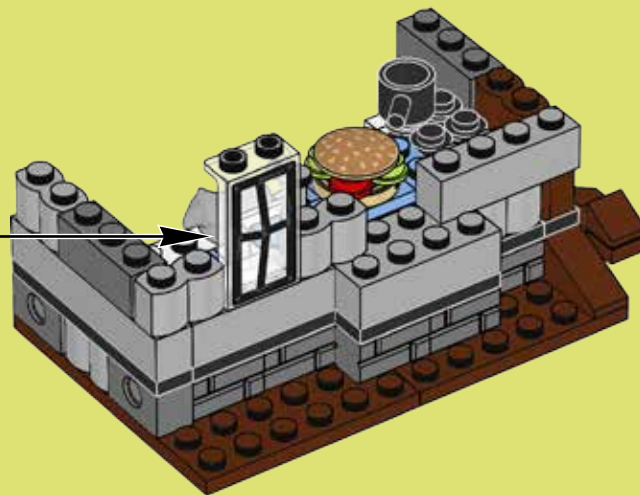
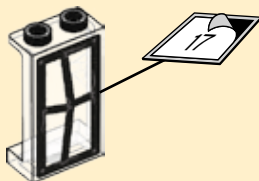



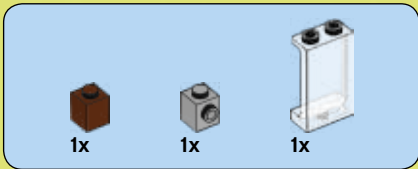

# 22

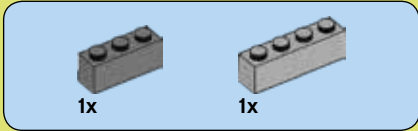
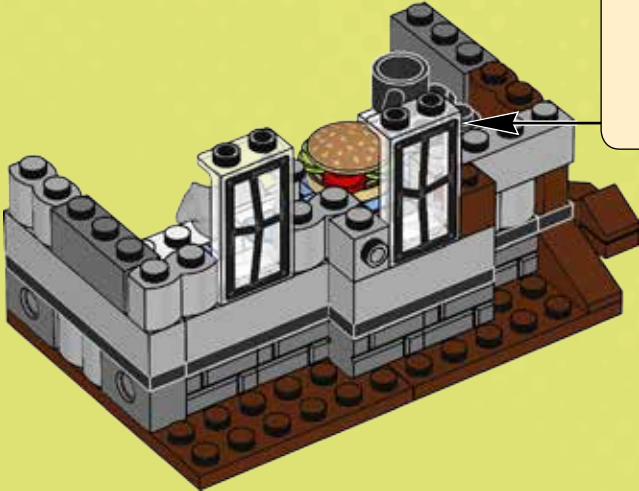
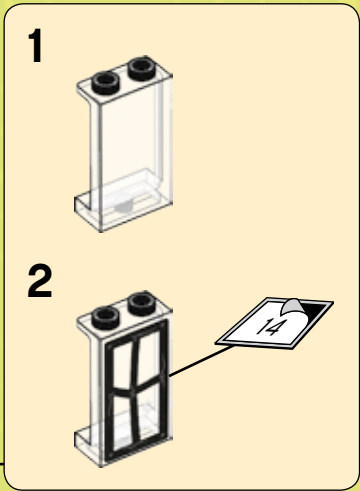

# 23

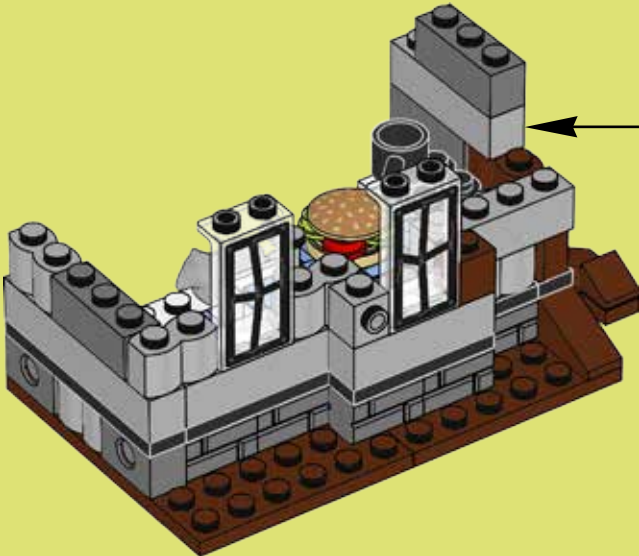
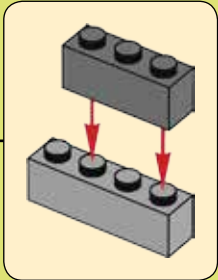

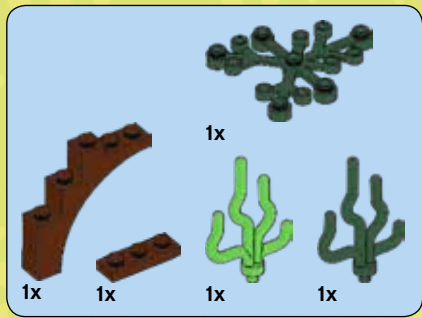

24

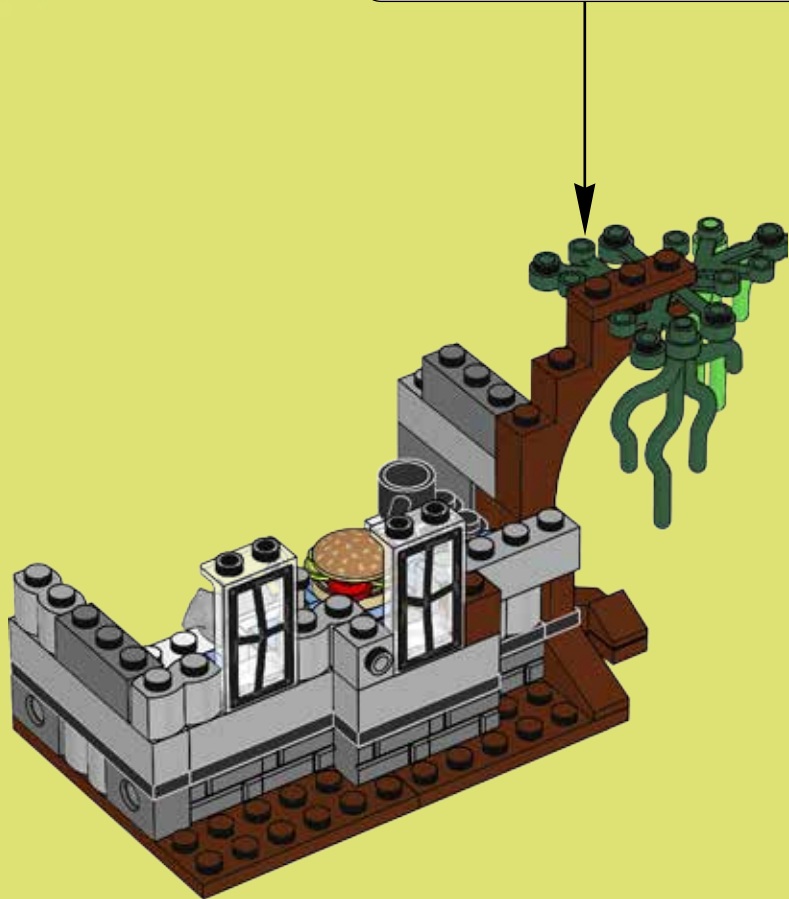
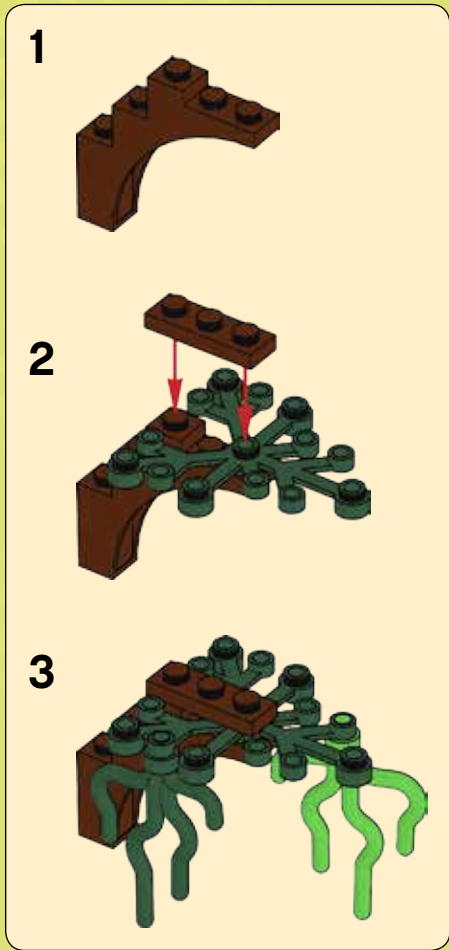



1x



1x

# 25

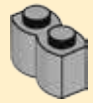
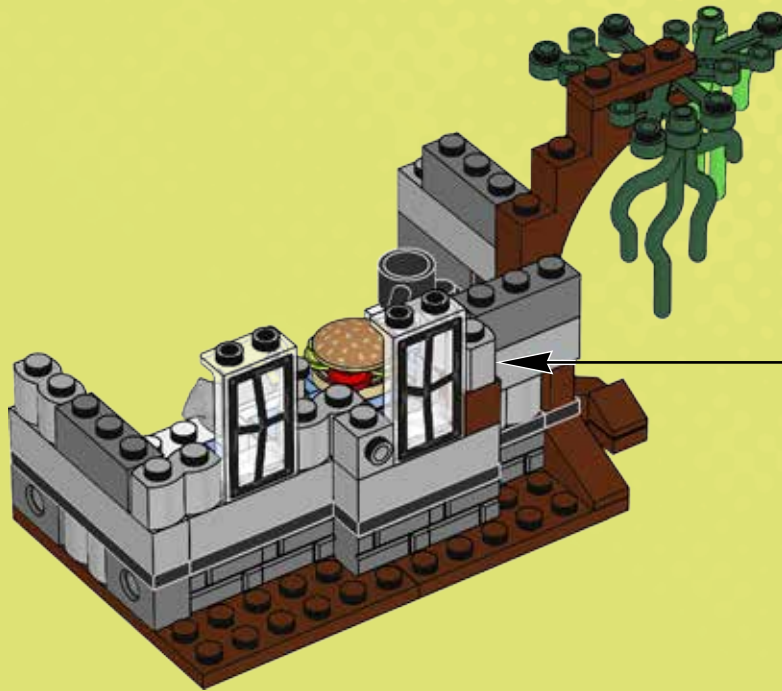

1x

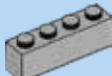

1x

# 26

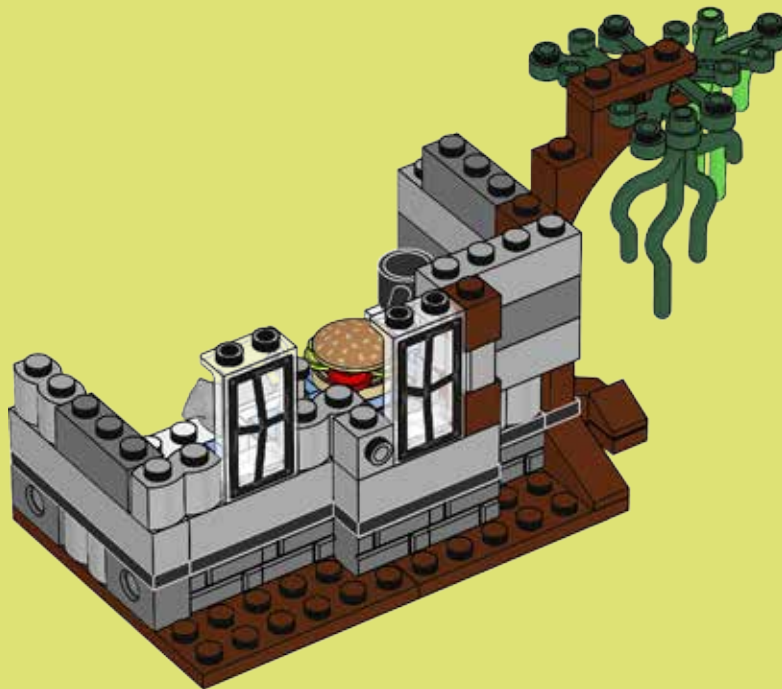

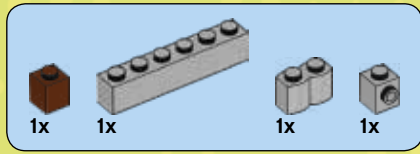

27

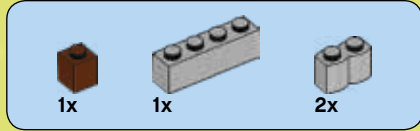
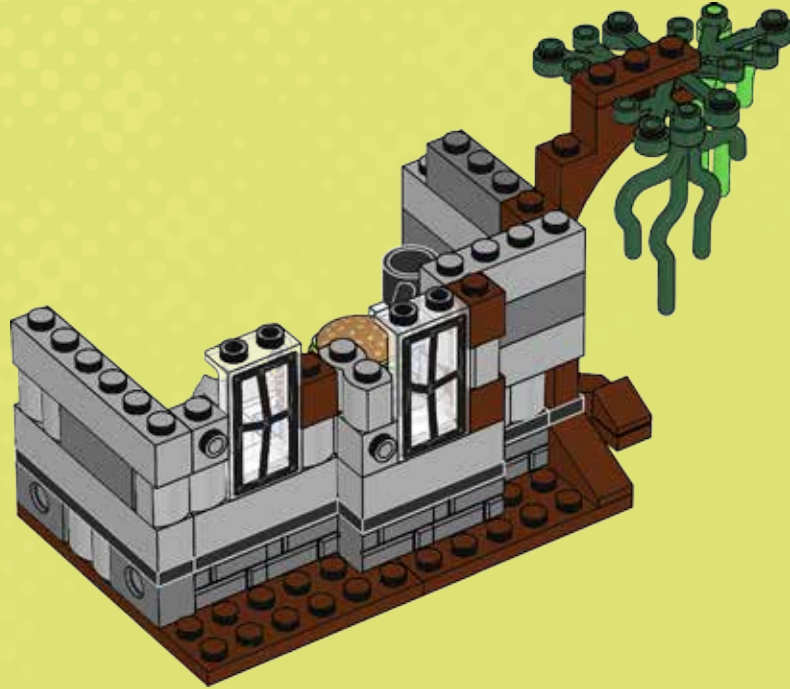

28

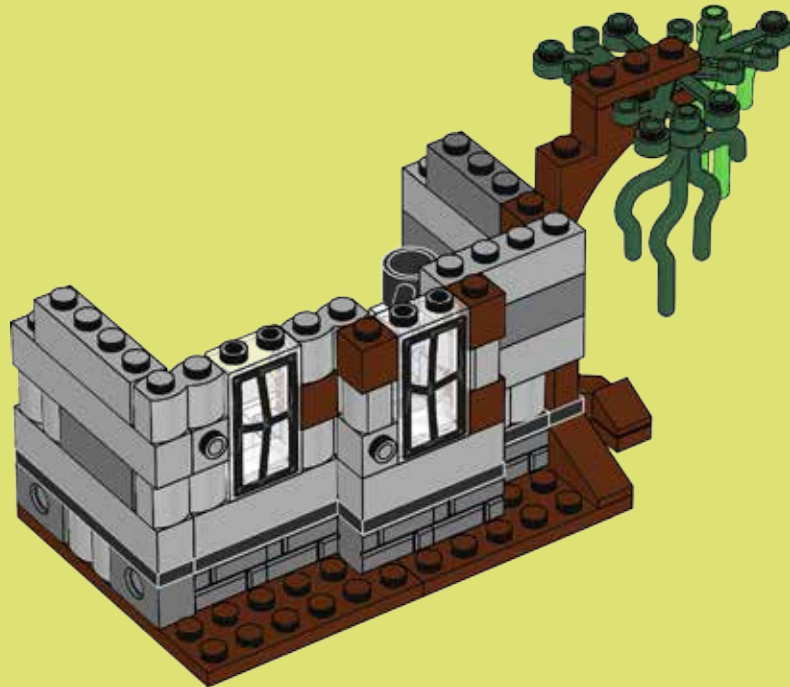



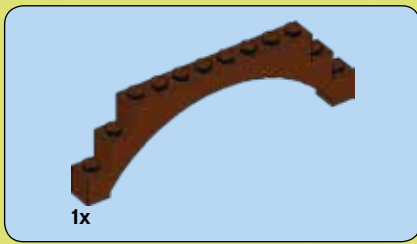

29

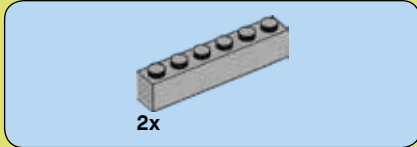
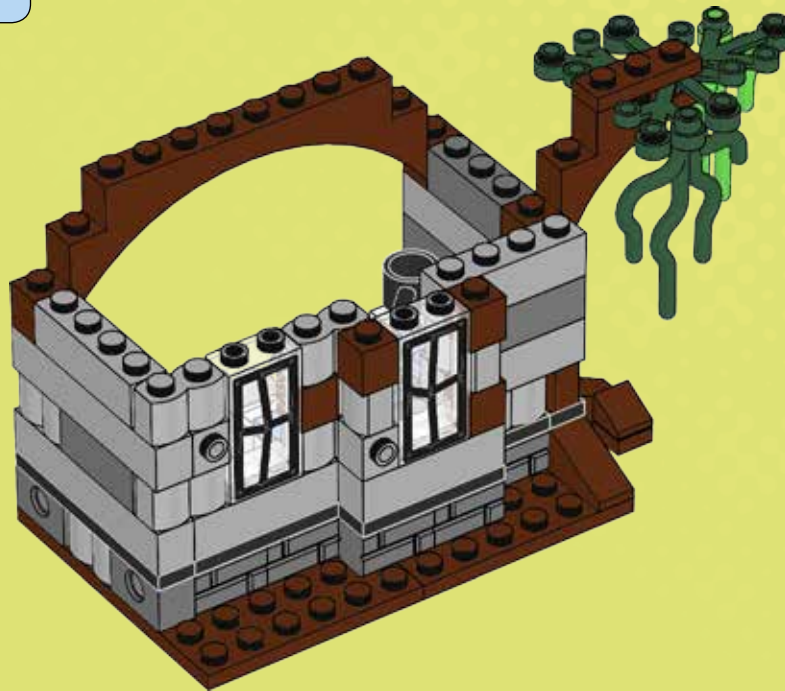

30

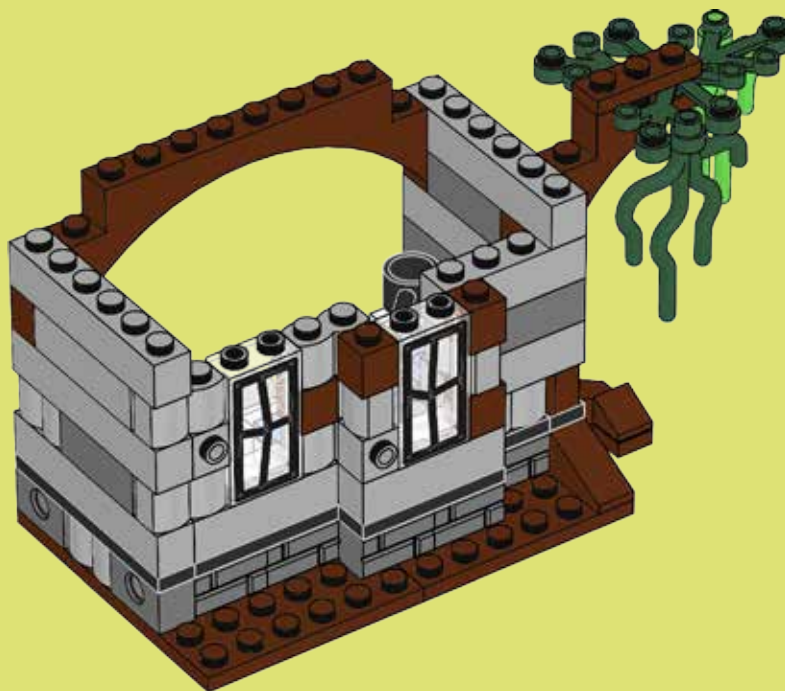

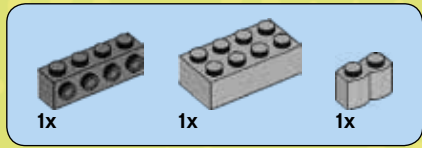

# 31

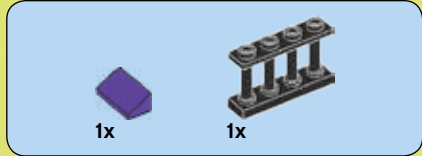
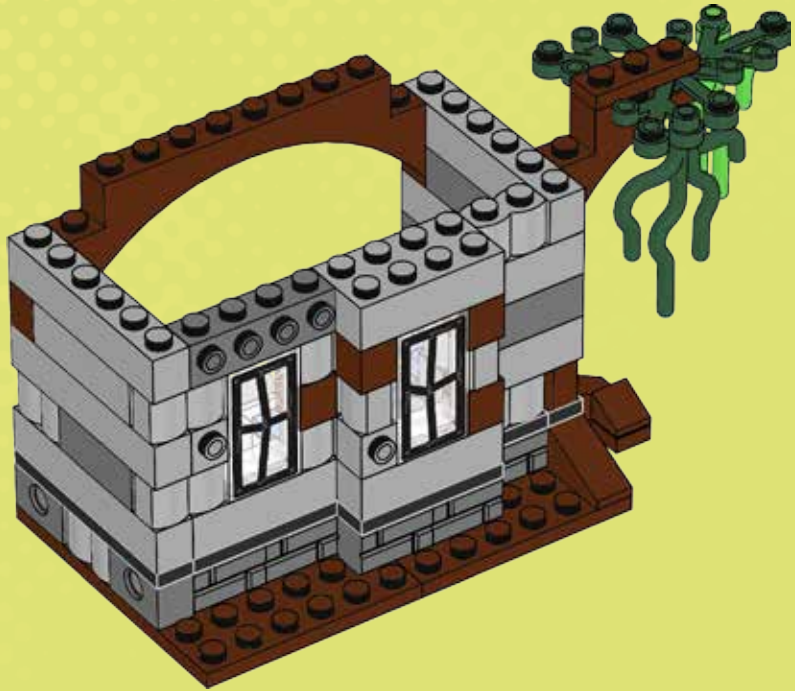

# 32

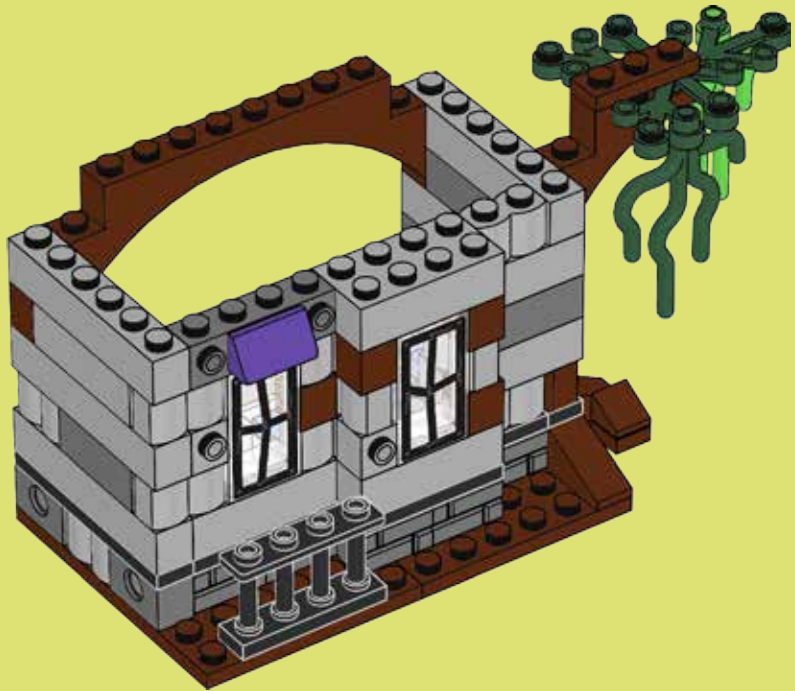



# 33

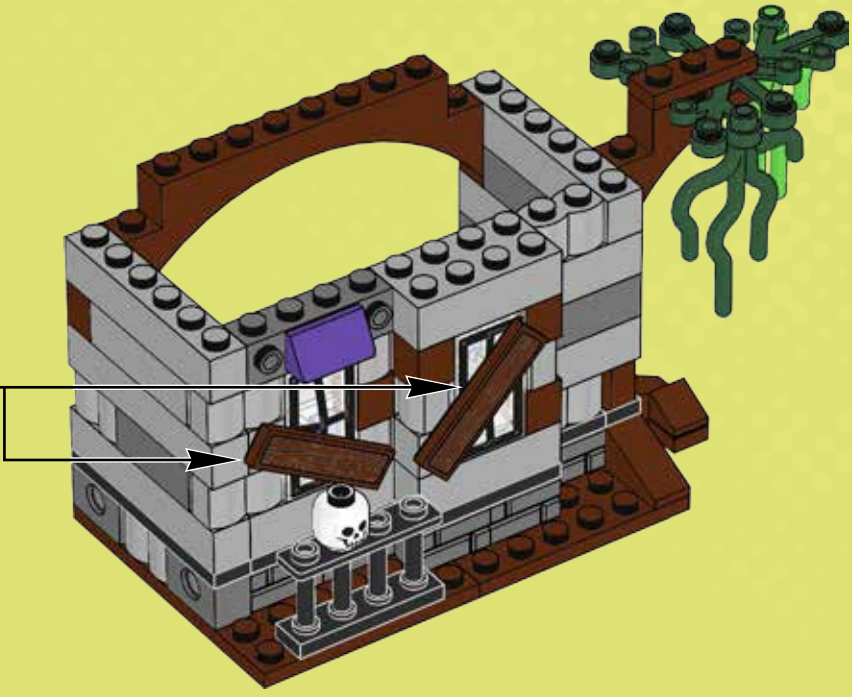
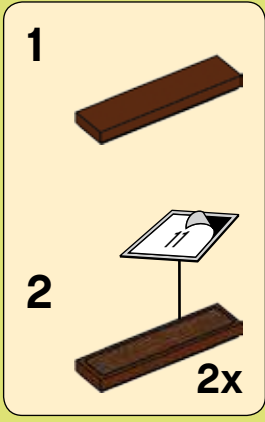

# 34

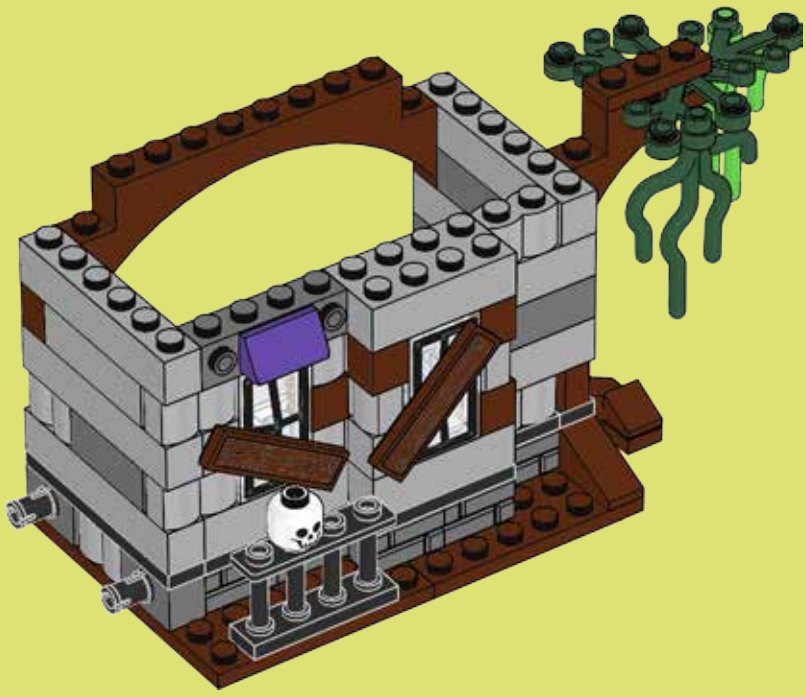

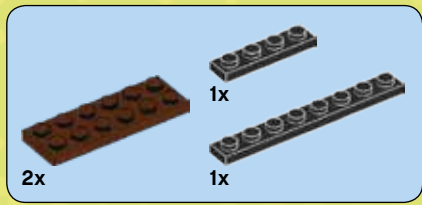
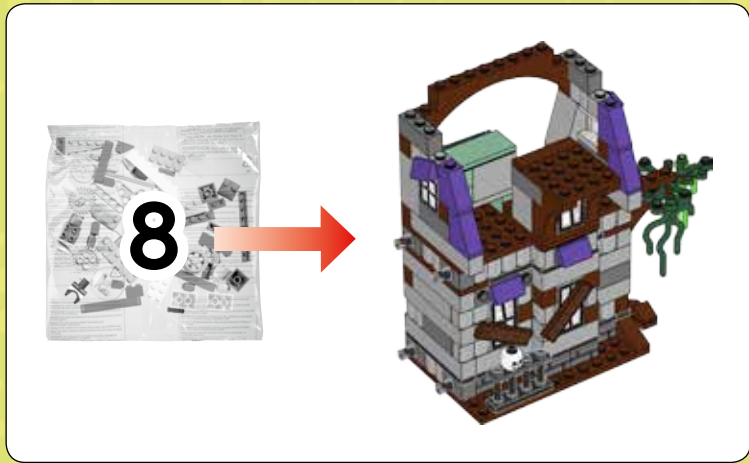

35

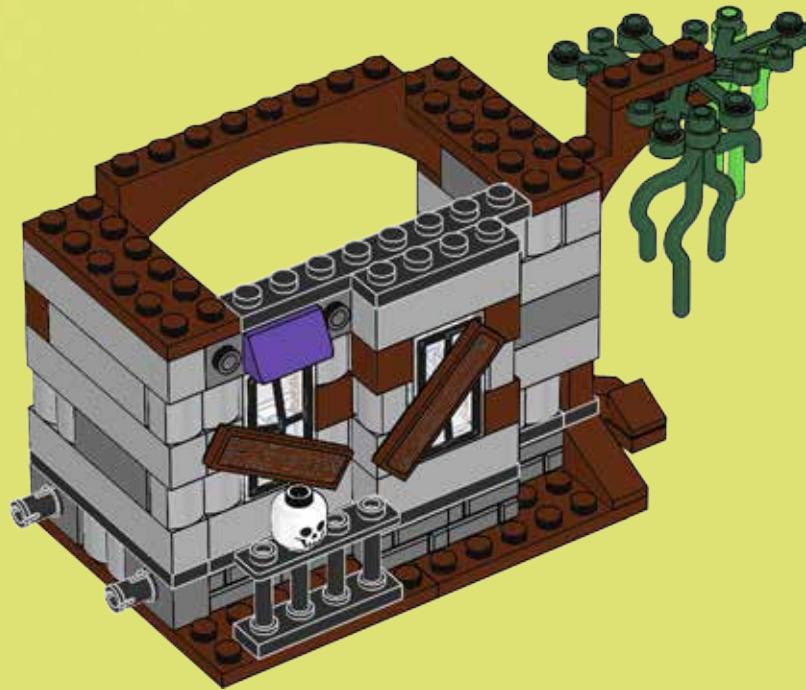



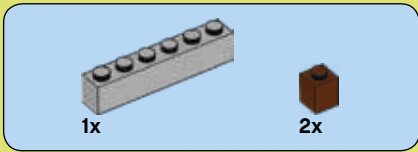

# 36

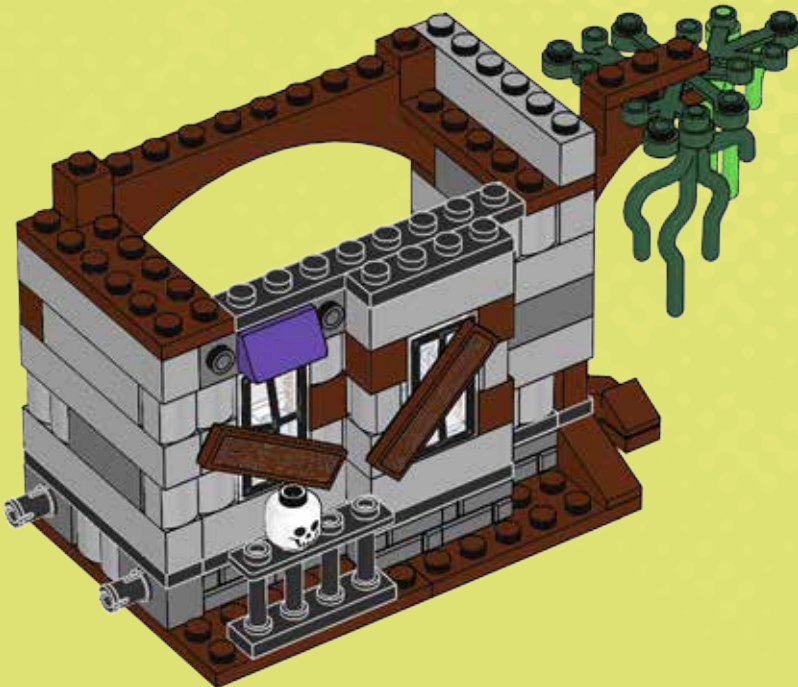

# 37

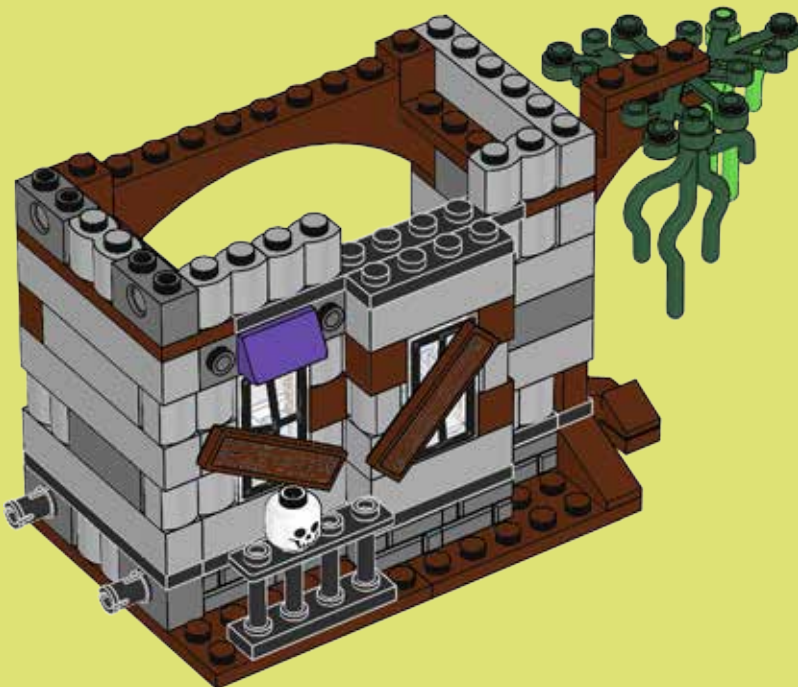

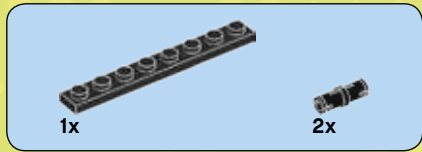

# 38

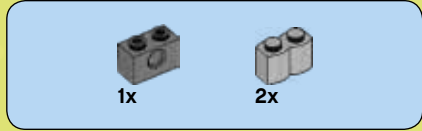
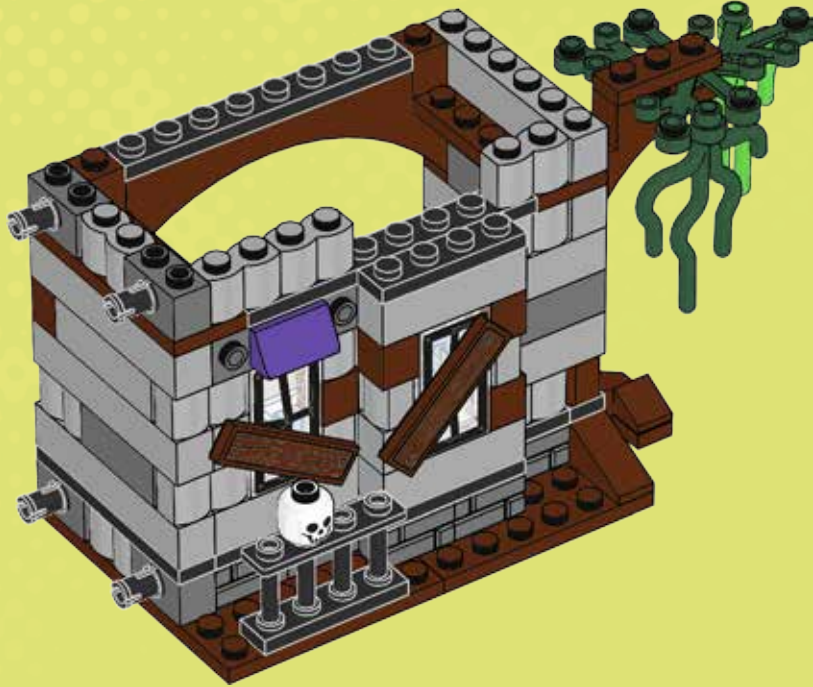

# 39

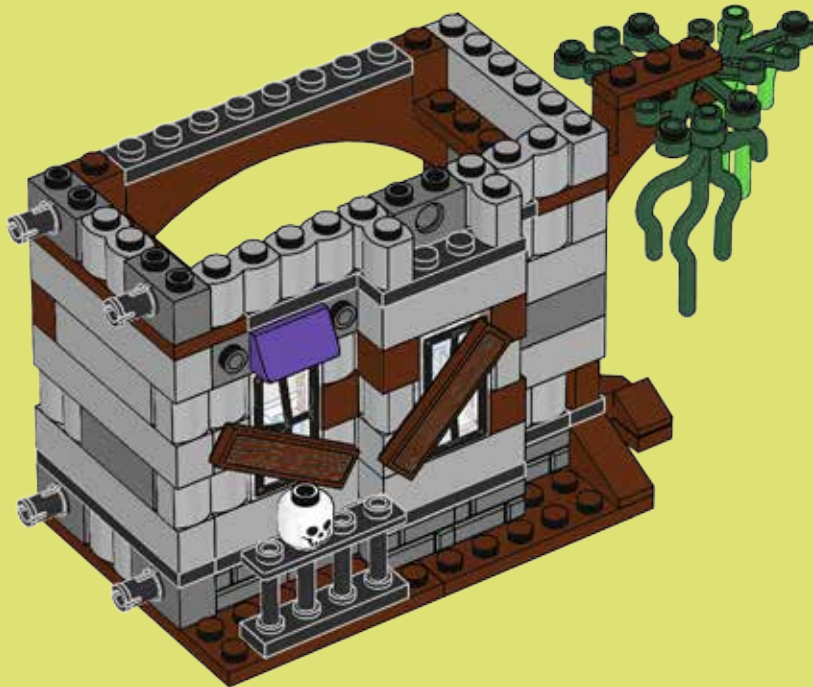



2x



1x

# 40

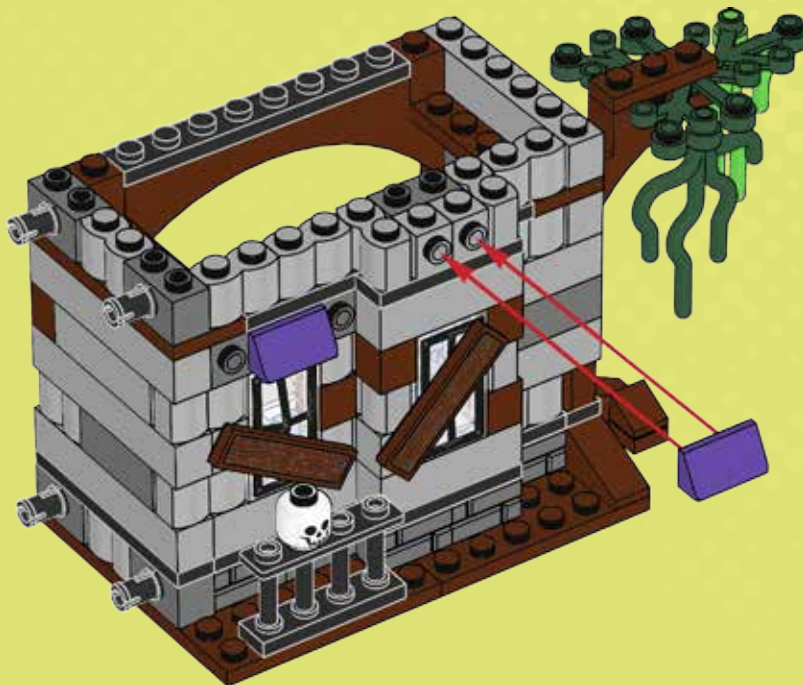

1x



2x

# 41

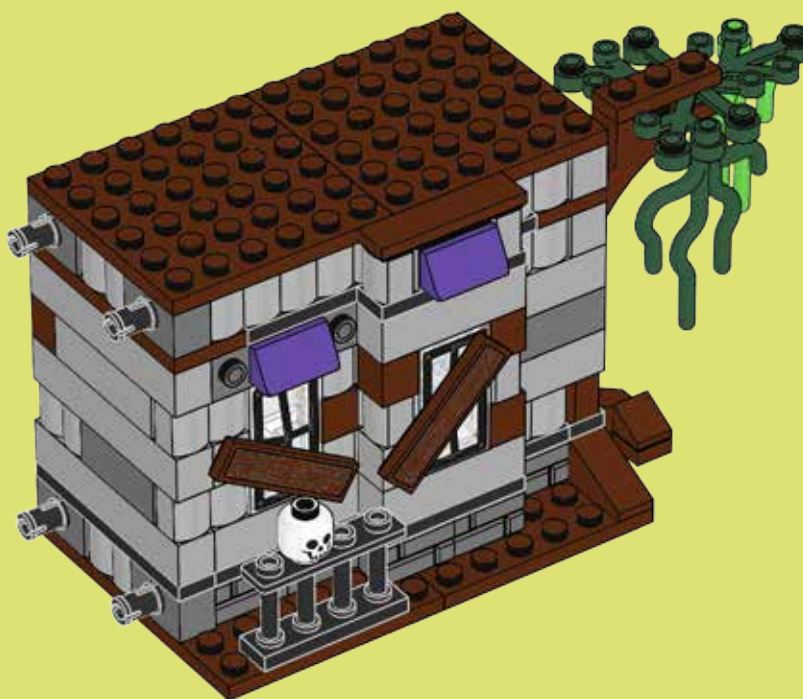





2x

# 42

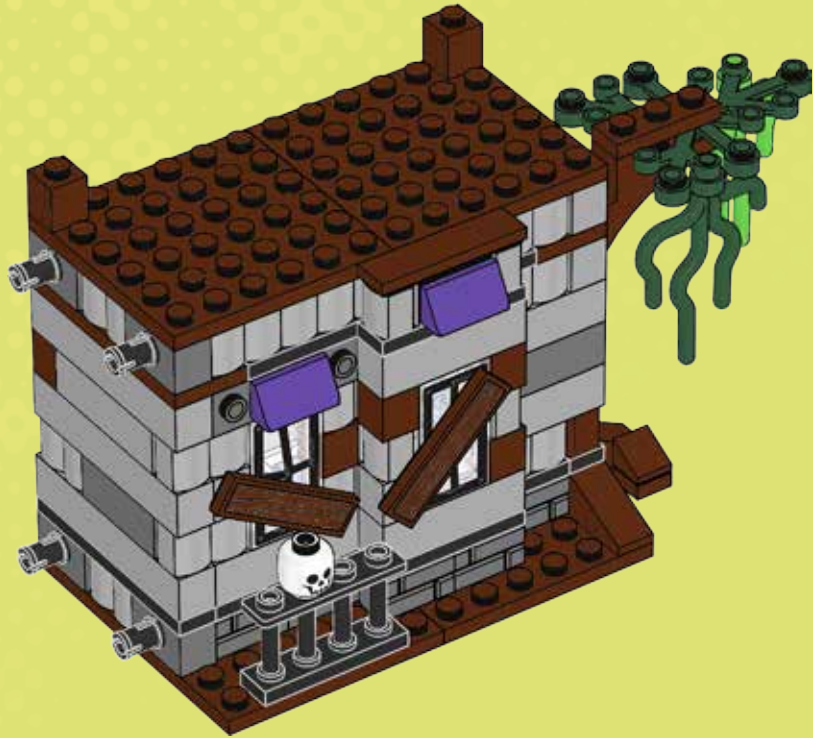

2x

# 43







2x

# 44



2x



2x

# 45





2x

# 46

1

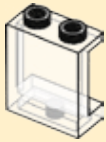

2

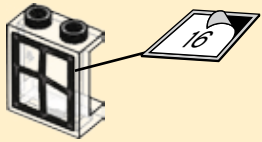

1



2

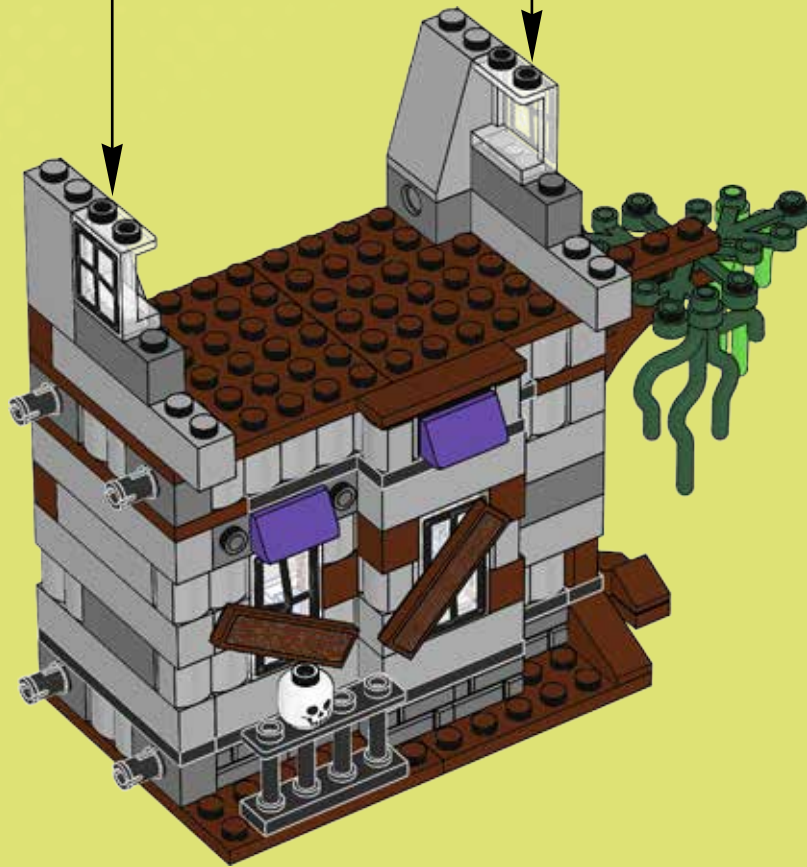
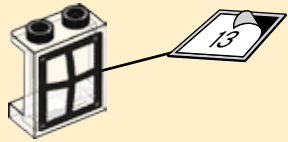



2x



2x

47



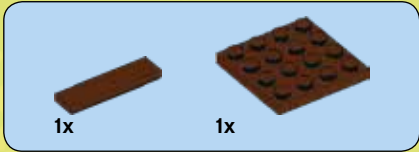

1

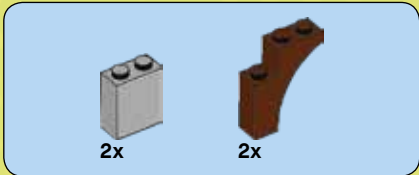
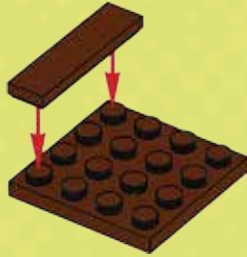

2

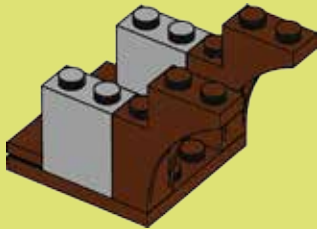

3

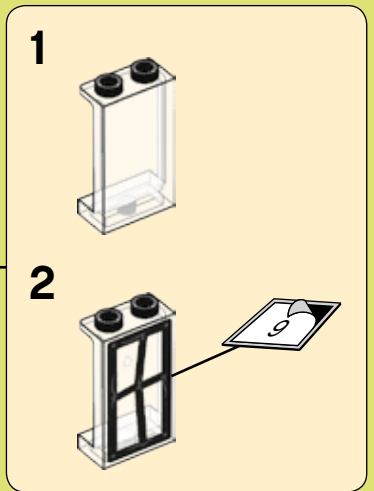
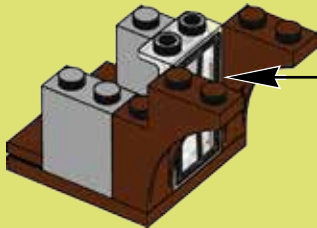



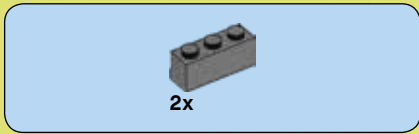

4

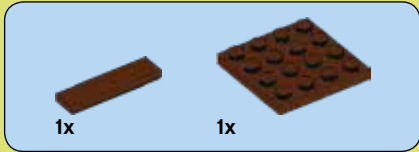
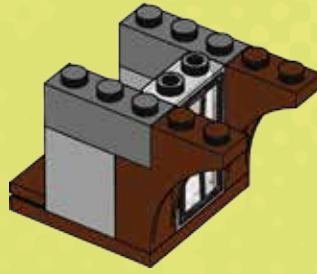

5

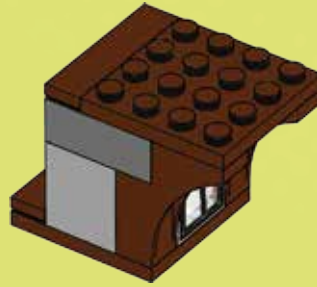

48



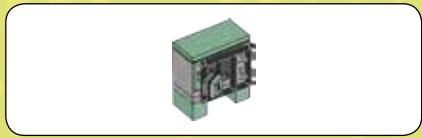

1

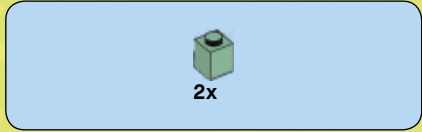

2

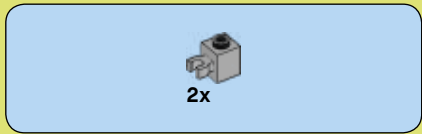
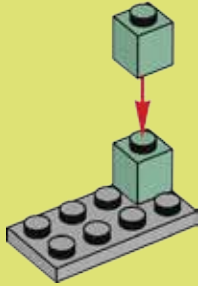

3

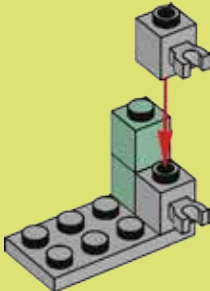

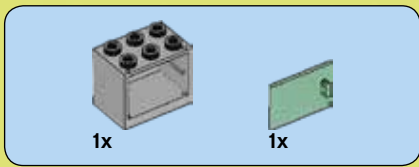

4

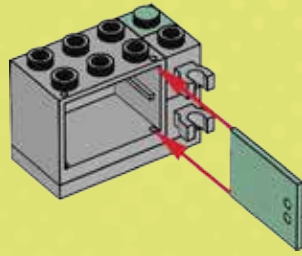

5

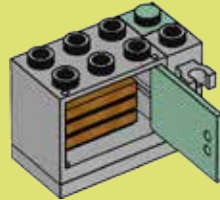

6

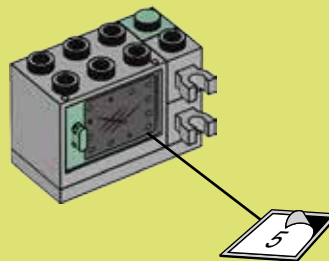

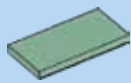

1x

7

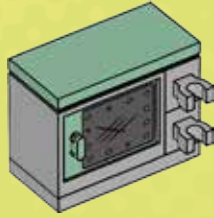

2x

8

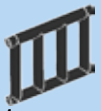
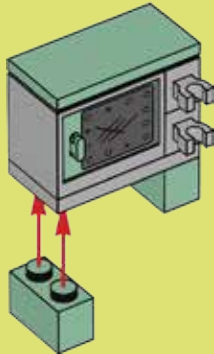

1x

9

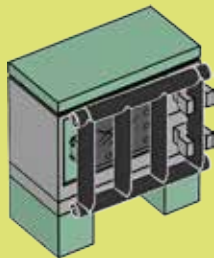





1x



1x

# 10

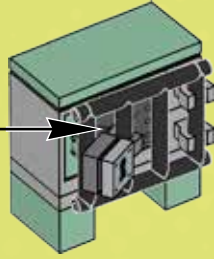
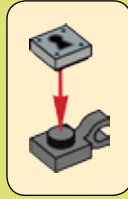

# 49

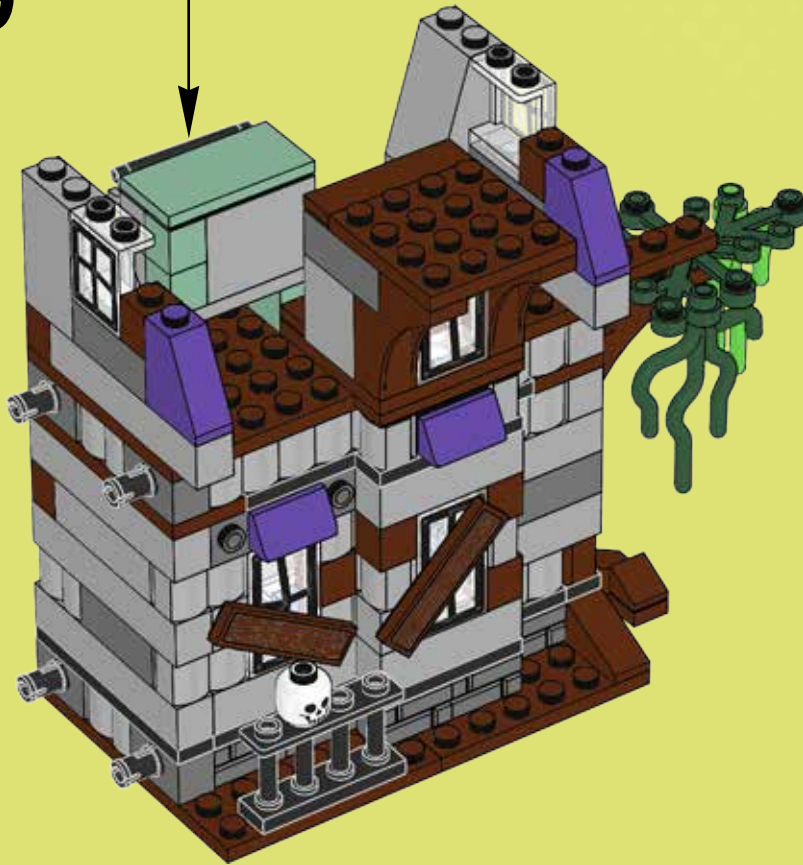



# 50



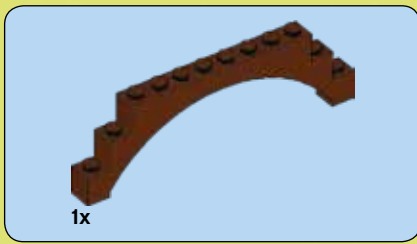

51

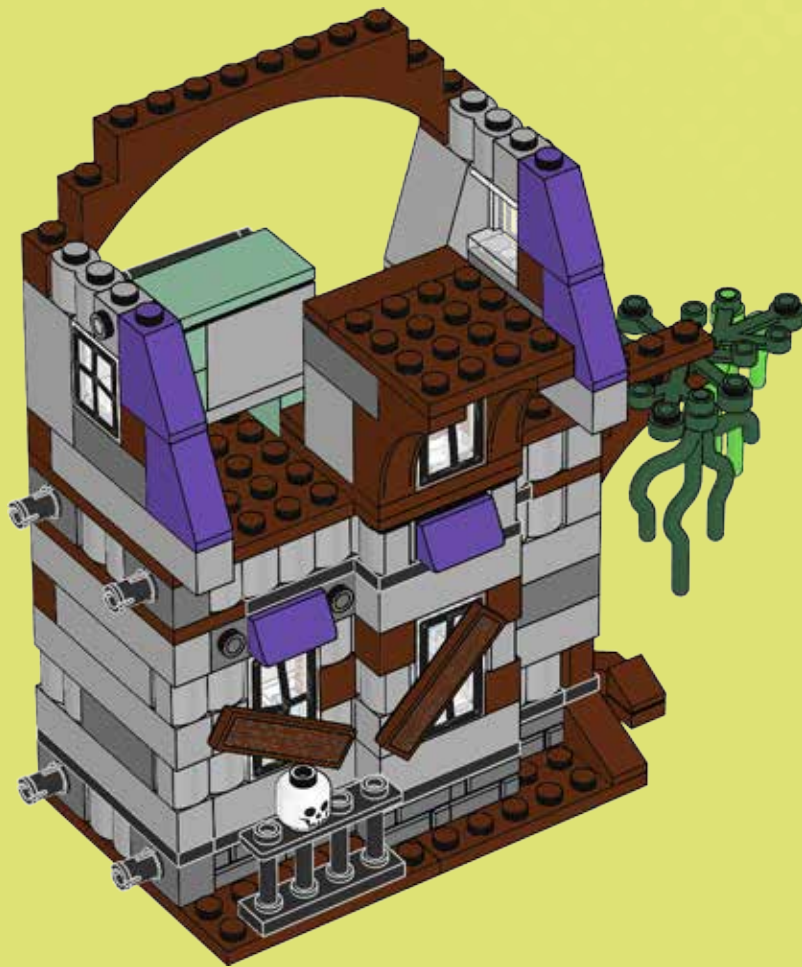



2x



2x

# 52





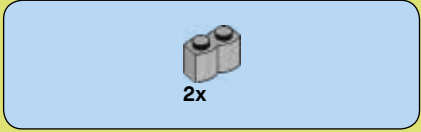

53



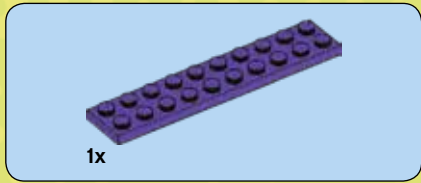
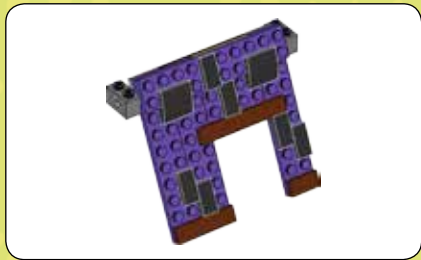

1

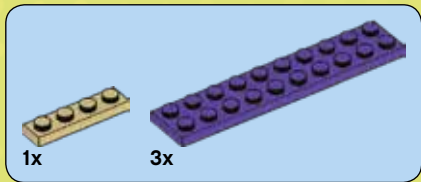
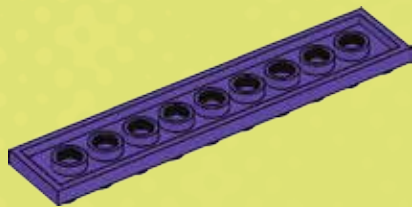

2

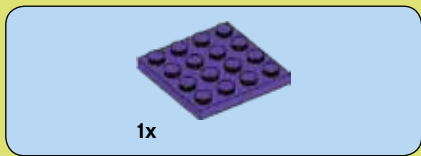
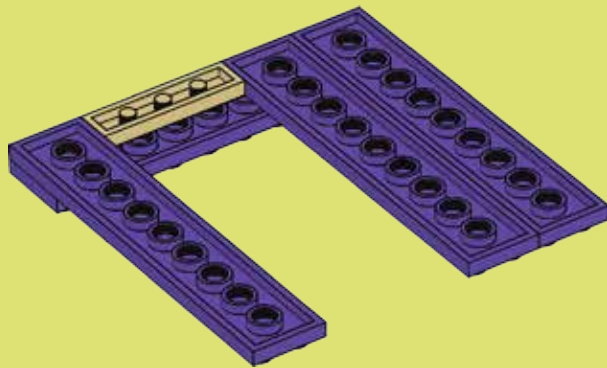

3

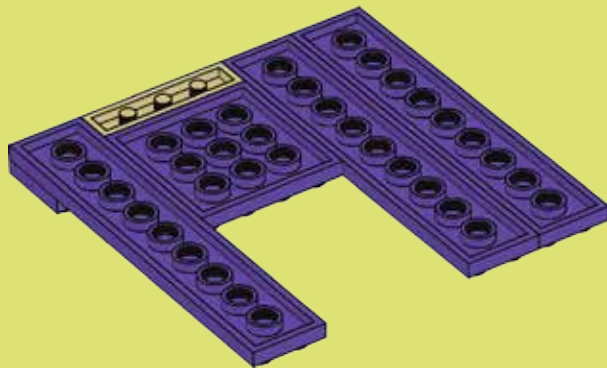



4

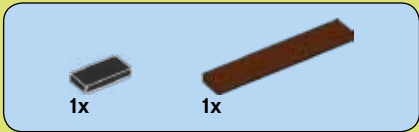
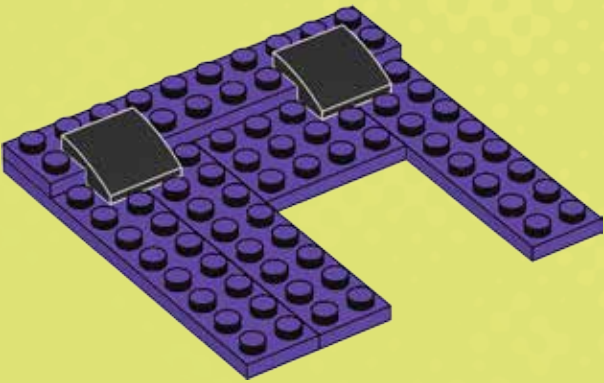

5

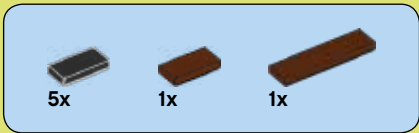
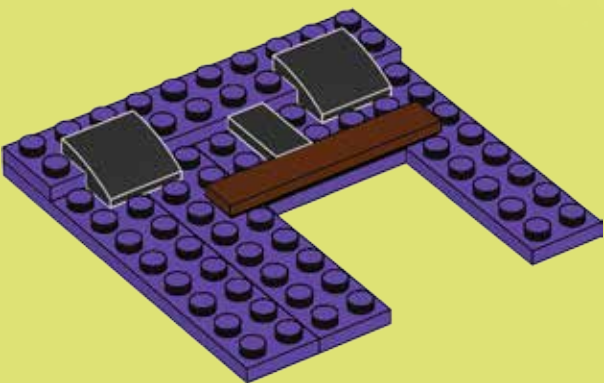

6

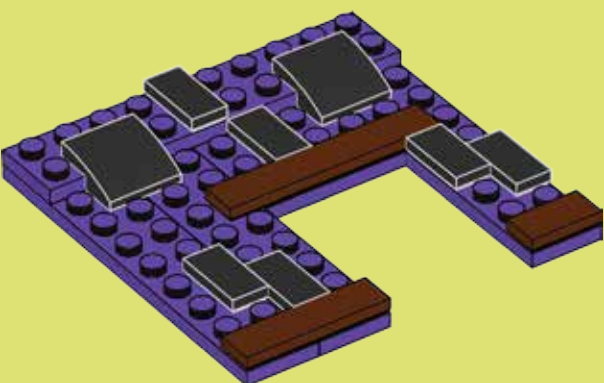



7

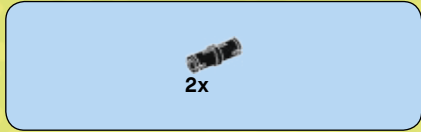
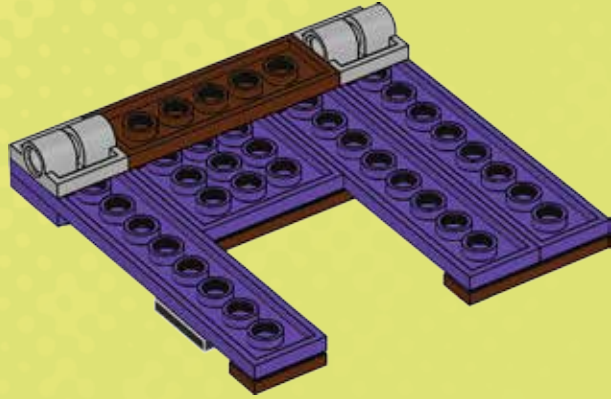

8

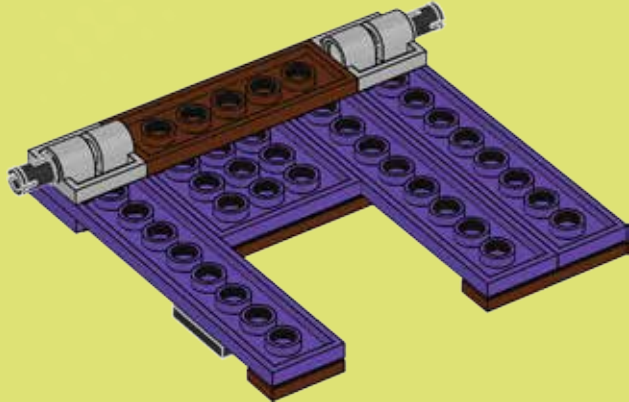

9

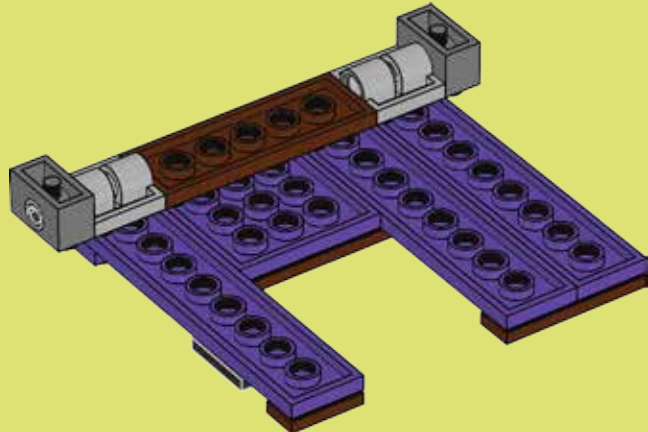



54

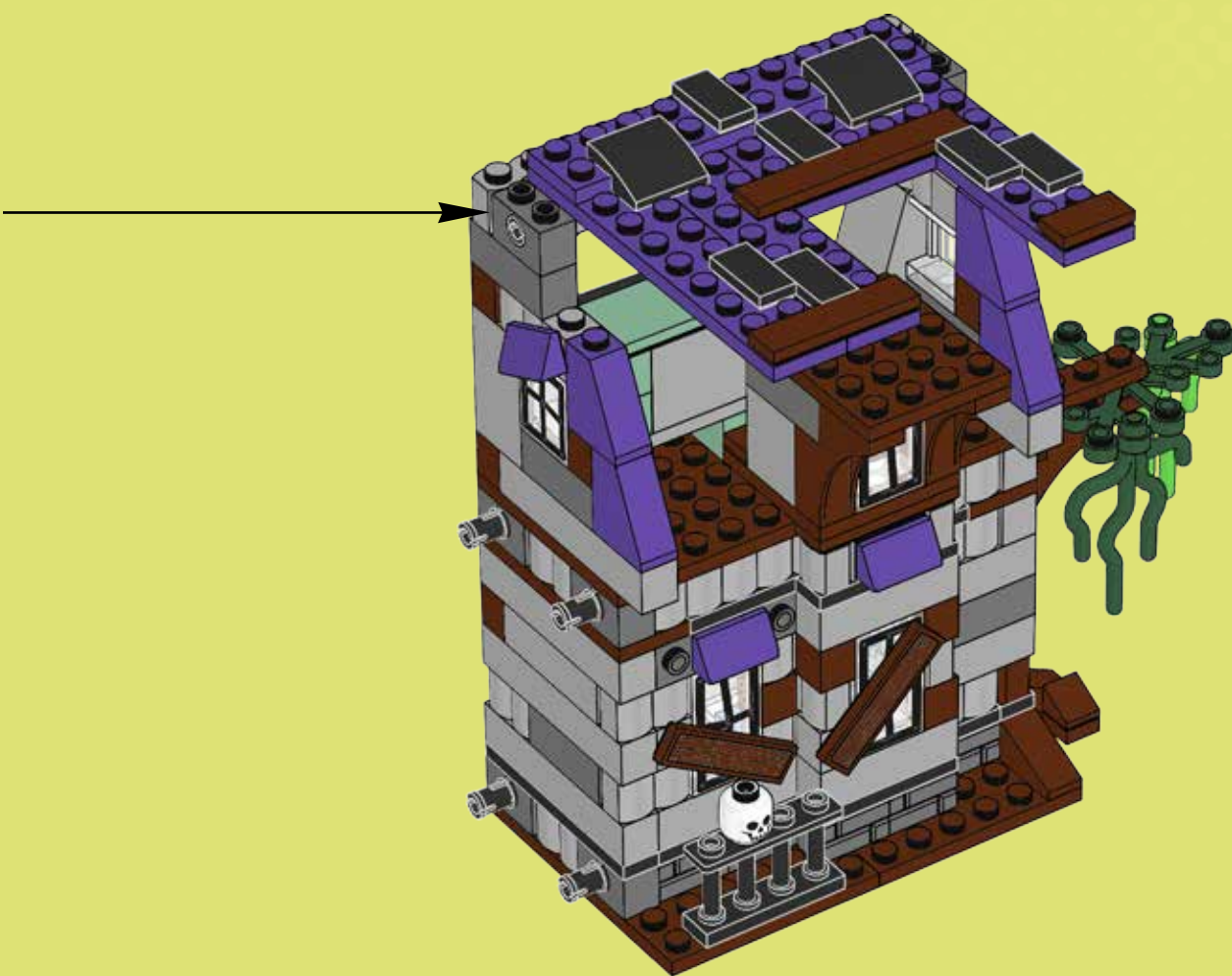



2x

# 55

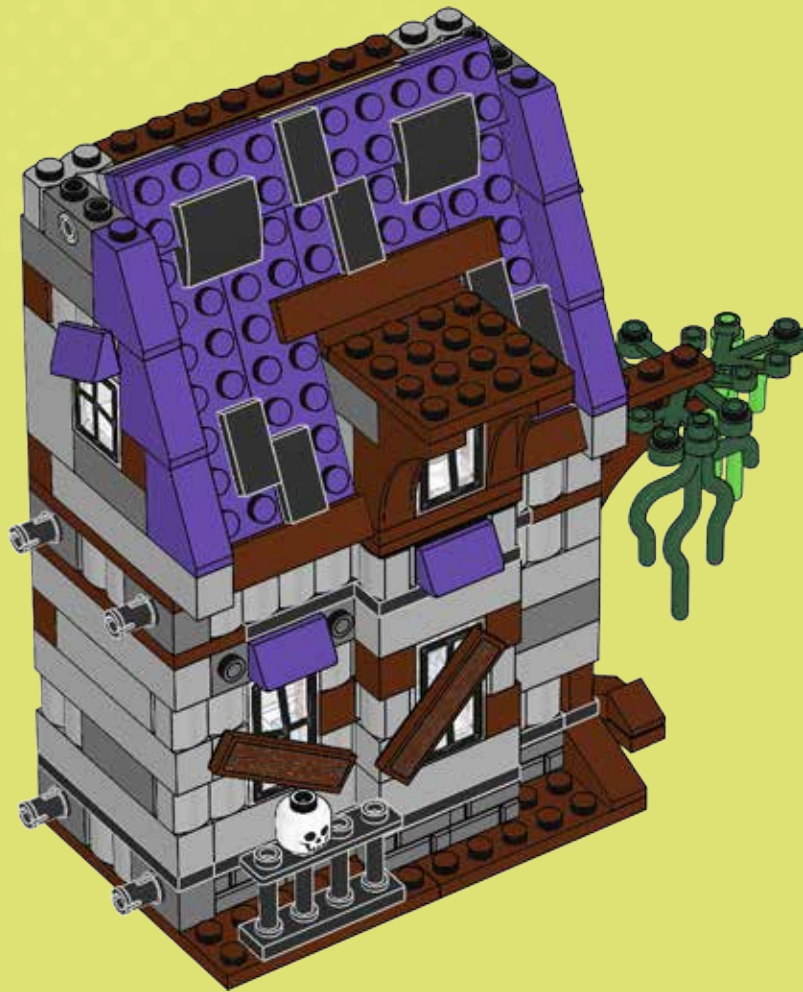



4x

# 56





2x

# 57

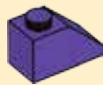

2x





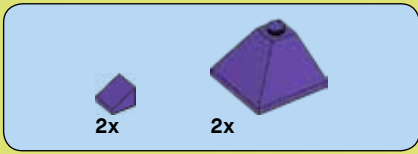

# 58





1x



1x

# 59



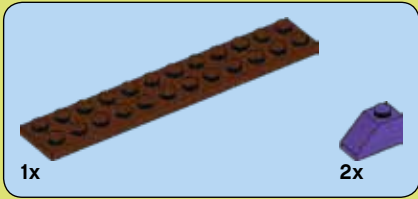

1

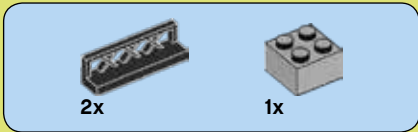
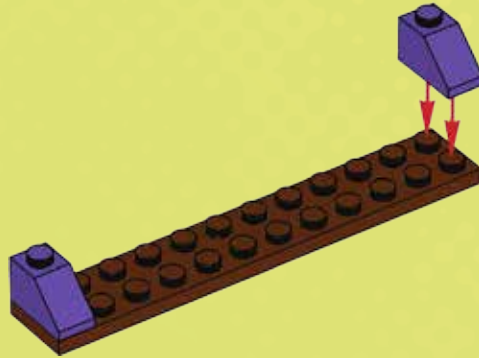

2

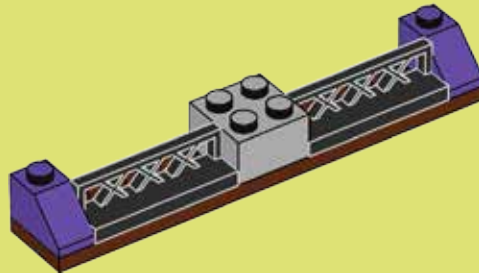

3

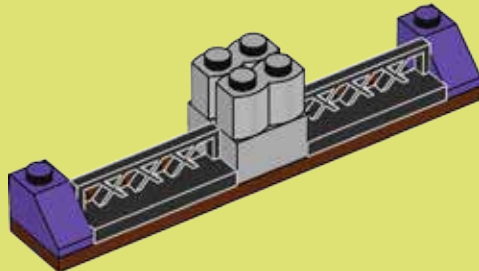

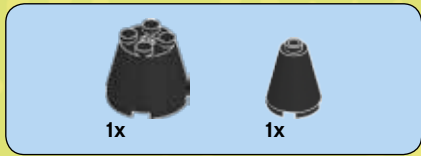

4

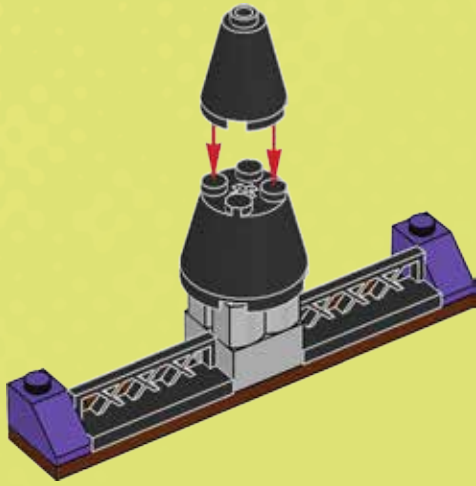

5

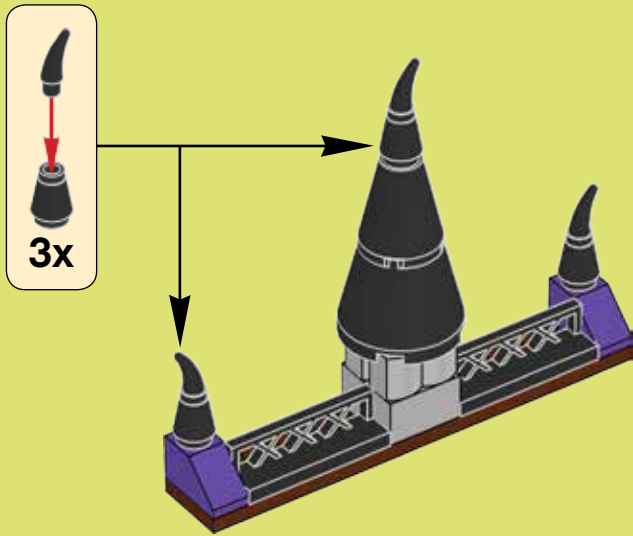





60

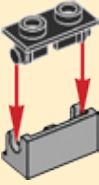
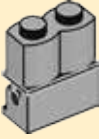

-  1x
-  1x
-  1x
-  2x
-  1x

# 61

- 1 
- 2 
- 3 
- 4 













# club™



1



[LEGO.com/club](http://LEGO.com/club)

2



3







Download Zappar App Scan the page Play Activity!

Zappar App herunterladen  
Seite scannen  
Spiespaß erleben!

Télécharge l'application Zappar  
Scanne la page  
Joue à l'activité !

Descarga la app Zappar  
Escanea la página  
¡Juega!

Descarrega a app Zappar  
Faz scan da página  
Joga com muita ação!

Töltsd le a Zappar appot.  
Szemeld be az oldalt  
Indítsd a játékot!



TM & © Hanna-Barbera.  
WB SHIELD: TM & © Warner Bros. Entertainment Inc.  
(s15)