



the **BIG BANG THEORY**™

21302



- 🇬🇧 Booklet available in English on
- 🇩🇪 Heft in deutscher Sprache erhältlich auf
- 🇫🇷 Livret disponible en français sur
- 🇪🇸 Folleto disponible en español en
- 🇵🇹 Folheto disponível em português em
- 🇮🇪 A füzet magyarul ezen a honlapon olvasható
- 🇮🇹 Libretto disponibile in italiano su

🇨🇳 如需中文版手册, 请访问 www.LEGO.com/ideas



THE BIG **BANG** THEORY

Drs. Leonard Hofstadter and Sheldon Cooper are brilliant physicists – geniuses in the laboratory, but socially challenged everywhere else. Enter beautiful, street-smart neighbor, Penny, who aims to teach them a thing or two about life. Despite their on-again, off-again relationship in the past, Leonard and Penny have finally gotten engaged. Even Sheldon has found a female companion – entering into a “Relationship Agreement” with neuroscientist Amy Farrah Fowler. In their free time, Leonard and

Sheldon enjoy fantasy role-playing games with their ever-expanding universe of friends, including fellow scientists Rajesh Koothrappali, Howard Wolowitz, and Howard’s adorable microbiologist wife, Bernadette.

Set in Pasadena, California, *The Big Bang Theory* was created by Chuck Lorre and Bill Prady, who are executive producers along with showrunner Steven Molaro. The series premiered on CBS in 2007 and is currently in its eighth successful season.





LEONARD

Leonard is an experimental physicist with an IQ of 173 who received his PhD at the age of 24. Originally from New Jersey, Leonard comes from a family of accomplished scientists. His mother is a world-renowned psychiatrist, his father is an anthropologist, his brother is an attorney who's argued cases before the Supreme Court, and his sister is a biologist. Leonard shares an apartment with his friend and colleague Sheldon Cooper.



SHELDON

He's a smart guy. Originally from East Texas and a child prodigy, he started college at the age of 11 and received his first doctorate at age 16. Today, he's a top theoretical physicist at Caltech. Sheldon's great loves are science and science fiction, although he has now entered into a "Relationship Agreement" with his girlfriend, neurobiologist Amy Farrah Fowler.



PENNY

Penny is Leonard and Sheldon's street-smart neighbor from across the hallway. Outgoing and self-assured, Penny's personality often contrasts with that of the guys. Originally from a small town in Nebraska, she worked as a waitress at a local restaurant while aspiring to become an actress. Now she has a job as a sales representative with a pharmaceutical company and is engaged to Leonard. Penny is also good friends with Amy and Bernadette, and the three of them often hang out in Penny's apartment.



AMY

Amy is a neuroscientist with a PhD in neurobiology and Sheldon's girlfriend. They share many of the same traits, both being extremely rational and sometimes awkward in social situations, so much so that Sheldon has created a 31-page "Relationship Agreement" for them. Amy is also best friends with Penny and Bernadette, who have helped her fit in better – more or less.



RAJ

Originally from New Delhi, India, Raj is Howard Wolowitz's best friend. He works as an astrophysicist at Caltech where he specializes in particle astrophysics. Like his friends, Raj is passionate about science fiction and comic books, and is also a big fan of Harry Potter. Raj's one claim to fame is that he once discovered a planetary object beyond the Kuiper Belt. Though much more confident than he used to be, he is still very shy around girls.



HOWARD

Howard is an aerospace engineer at Caltech's Department of Applied Physics with a master's in engineering from MIT. Unlike Leonard, Sheldon, and Raj, Howard has no doctorate, preferring the practical endeavors of engineering to the theoretical work of his friends. His skills as an engineer eventually allow him to fulfill his dream of becoming an astronaut. Howard marries his girlfriend, Bernadette, shortly before he leaves on his mission to visit the International Space Station.



BERNADETTE

Bernadette is a microbiologist and also Howard Wolowitz's wife. She became friends with the others while waitressing at the same restaurant as Penny to pay for her graduate studies in microbiology. Though generally friendly and good-natured, she can also be quite intimidating when she has to be. While Bernadette claims she can safely handle the world's most dangerous viruses, not all her experiments in the laboratory end successfully – as her time in quarantine demonstrates.



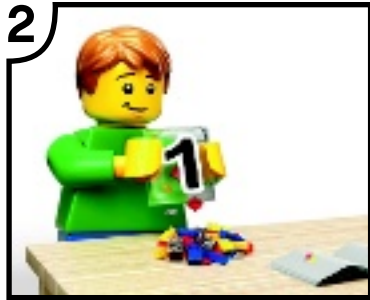

LEGO.com/brickseparator

$$\frac{-m+1}{(p-2)^2}$$

$$\frac{p^3}{F(p)(p-2)^m}$$

Cn 211

(n-1)

= l

(1/p)

(1/p)

(1/p)

(1/p)

(1/p)

(1/p)

(1/p)

(1/p)

(1/p)

(1/p)

(1/p)

(1/p)

(1/p)

(1/p)

(1/p)

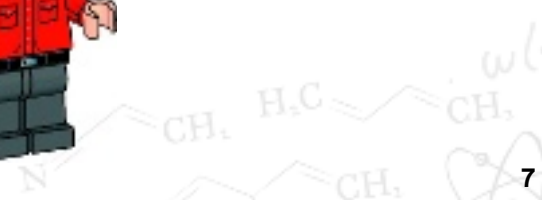
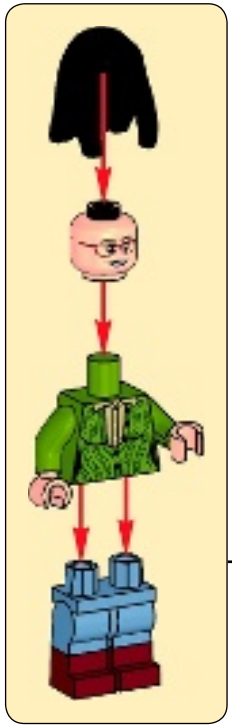
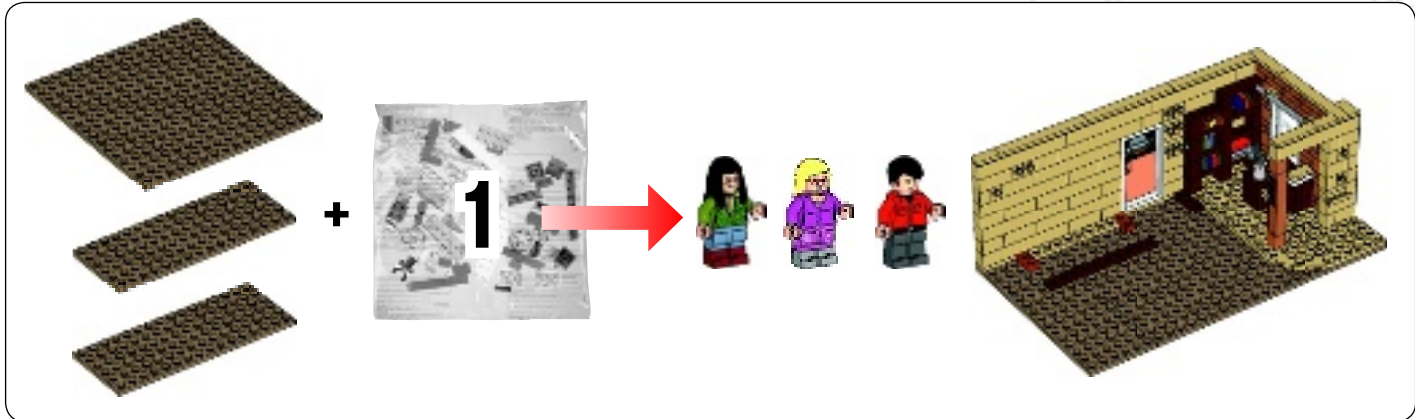

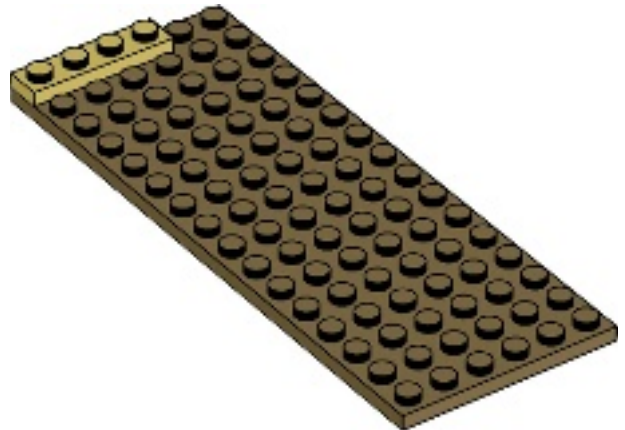
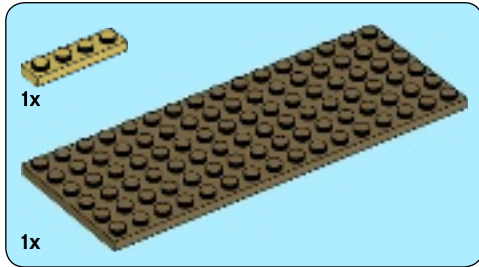

1

$$\frac{-m+1}{(p-2)^m} = \frac{p^3}{F(p)(p-2)^m}$$

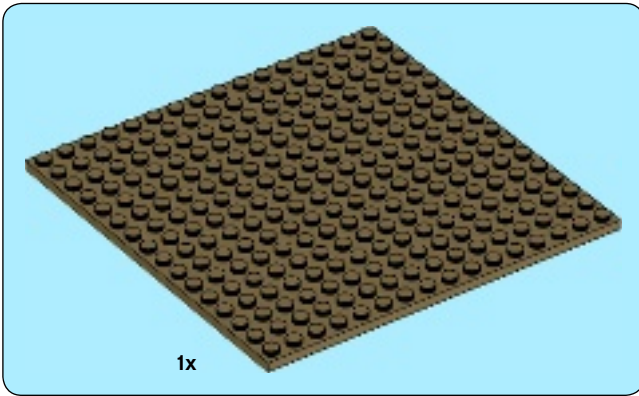

2

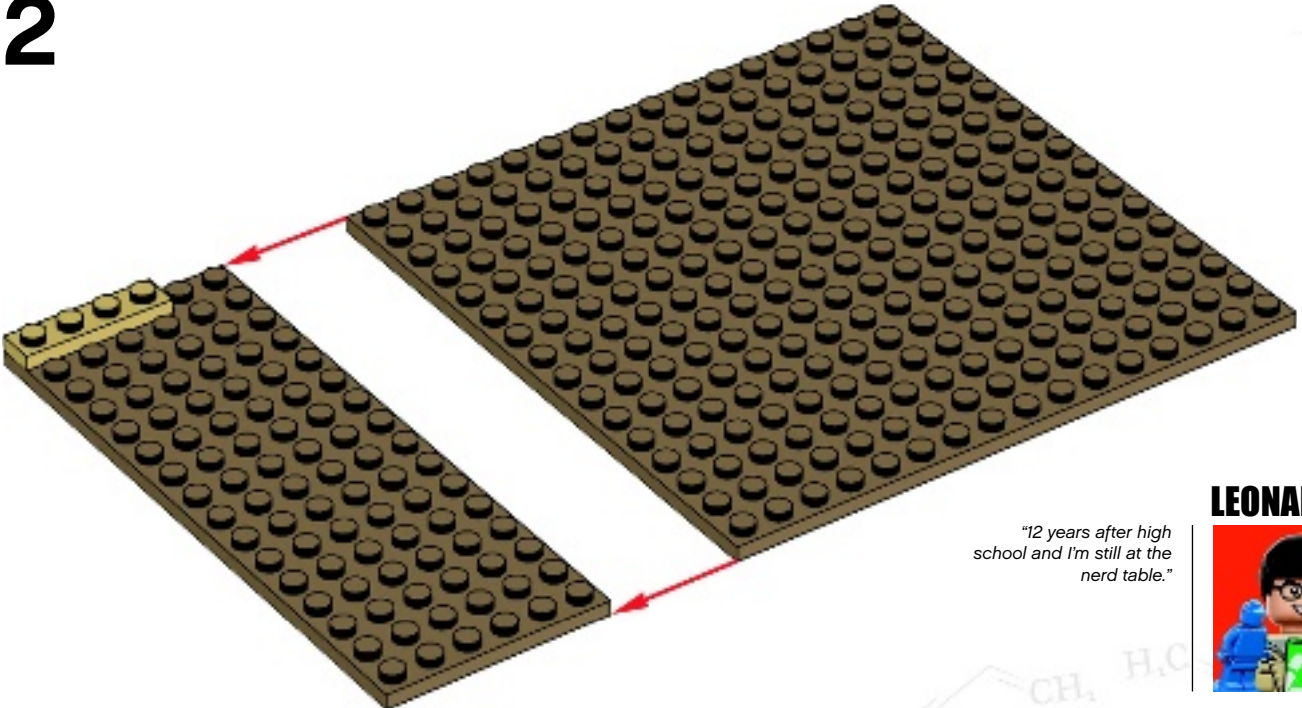

LEONARD

"12 years after high school and I'm still at the nerd table."



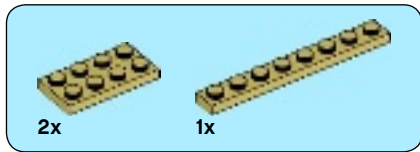

3

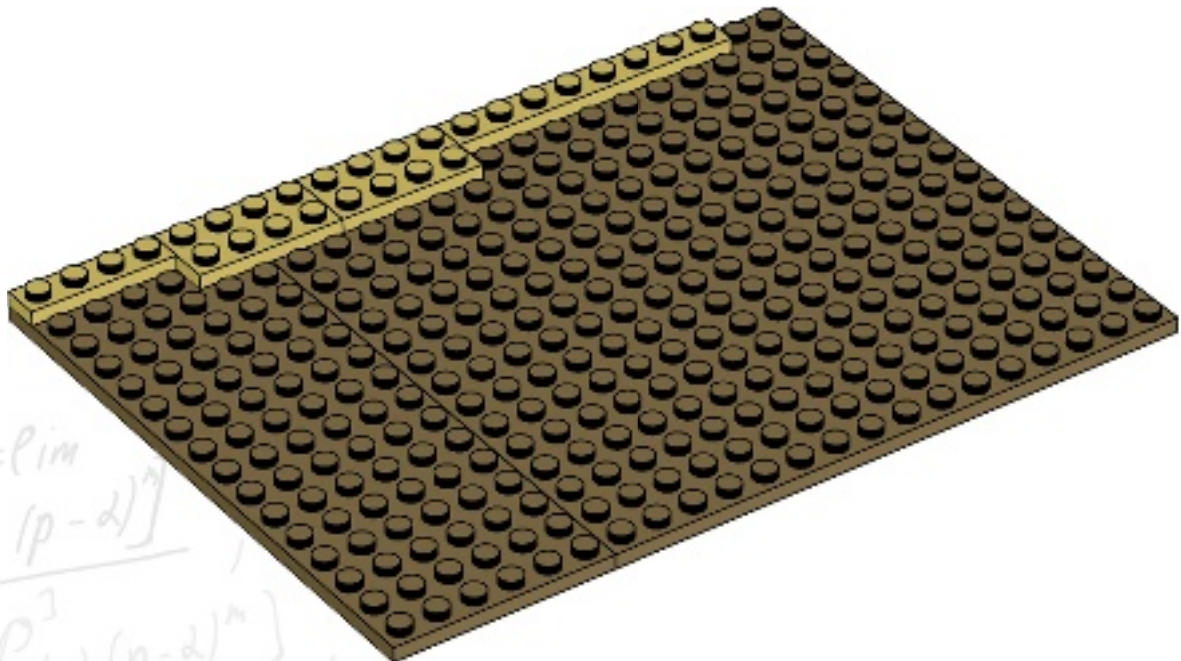

2
-m+1 = p im
 $(p-2)^m$
 p^2
 $F(p)(p-2)^m$

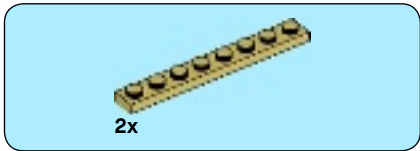

5

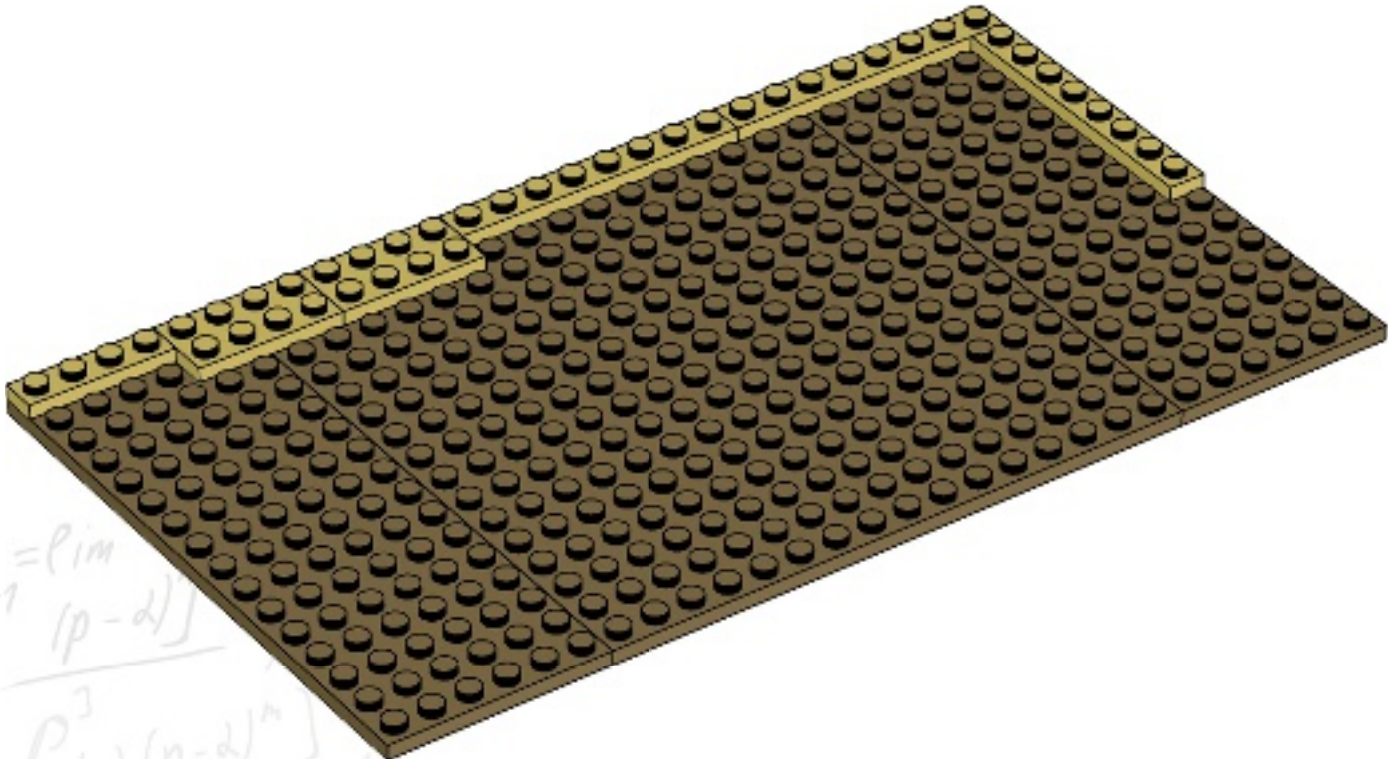

2

$= p \cdot m$
 $-m+1$
 $(p-d)$

p^3
 $F(p)(p-d)^m$



6

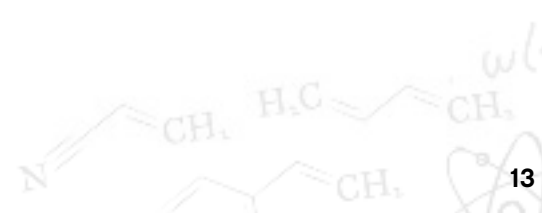
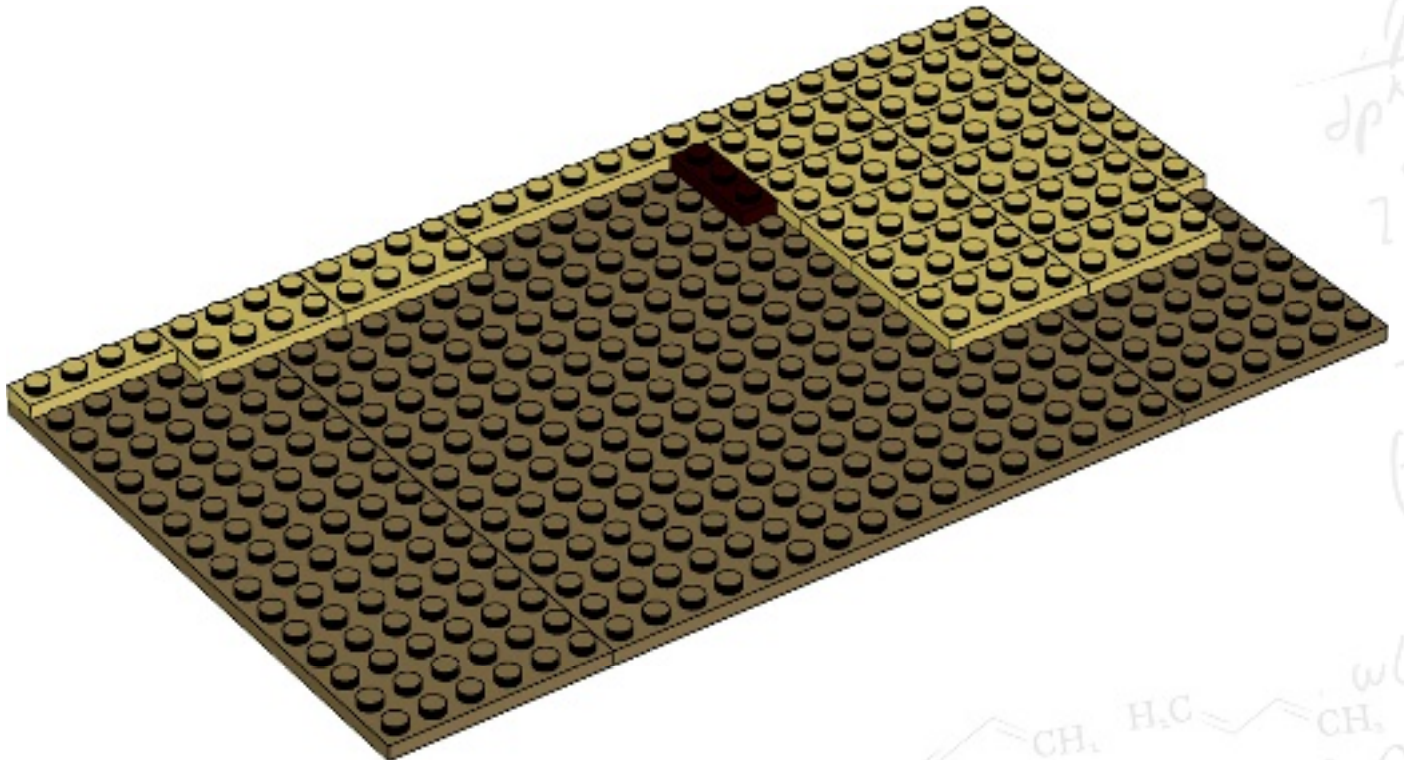

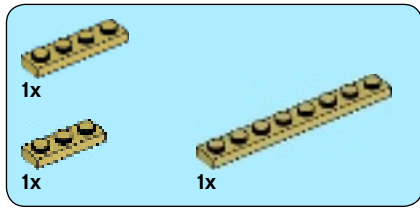

7

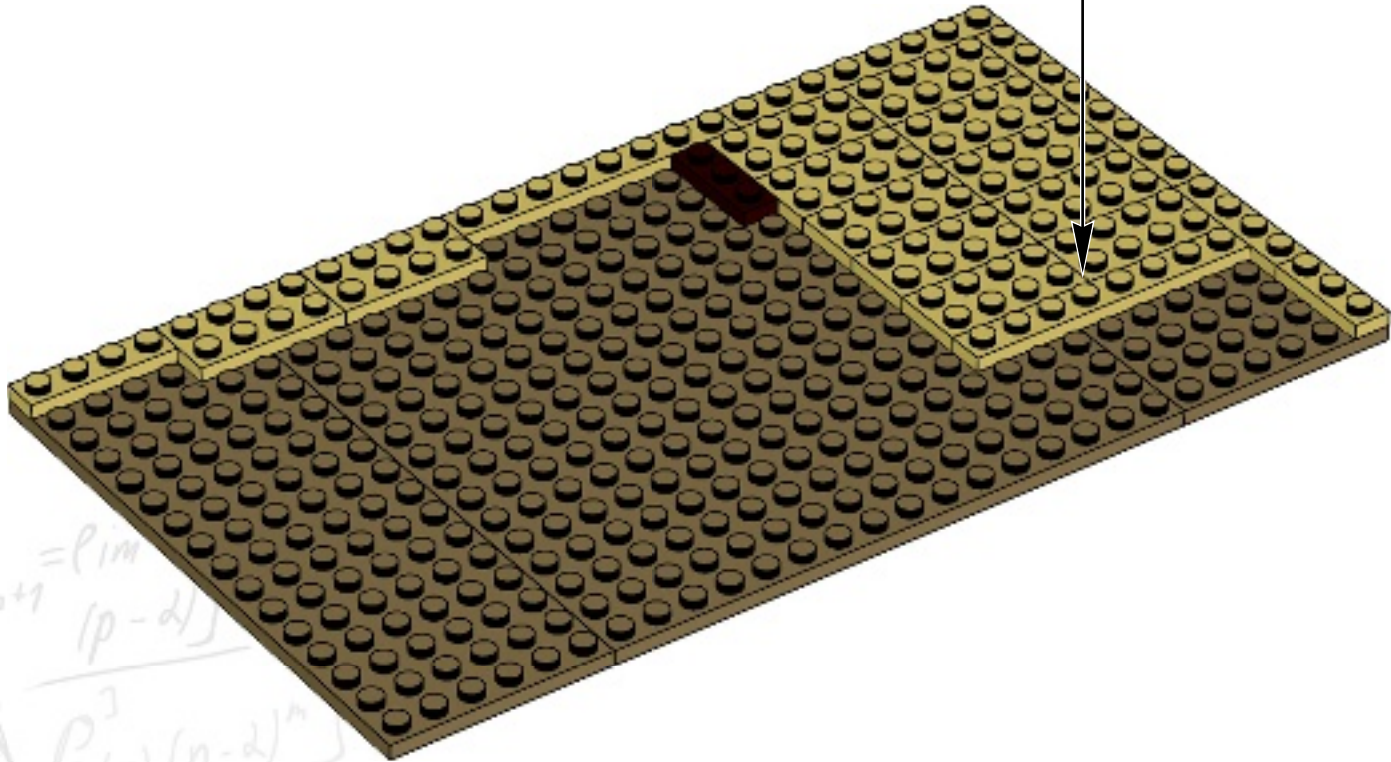
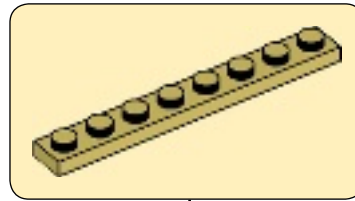

2
 $= p \cdot m$
 $-m+1$
 $(p-2)$
 p^3
 $F(p)(p-2)^m$

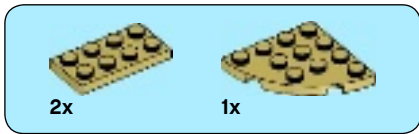

8

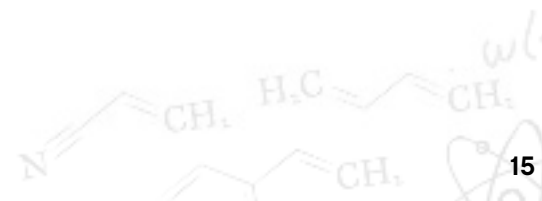
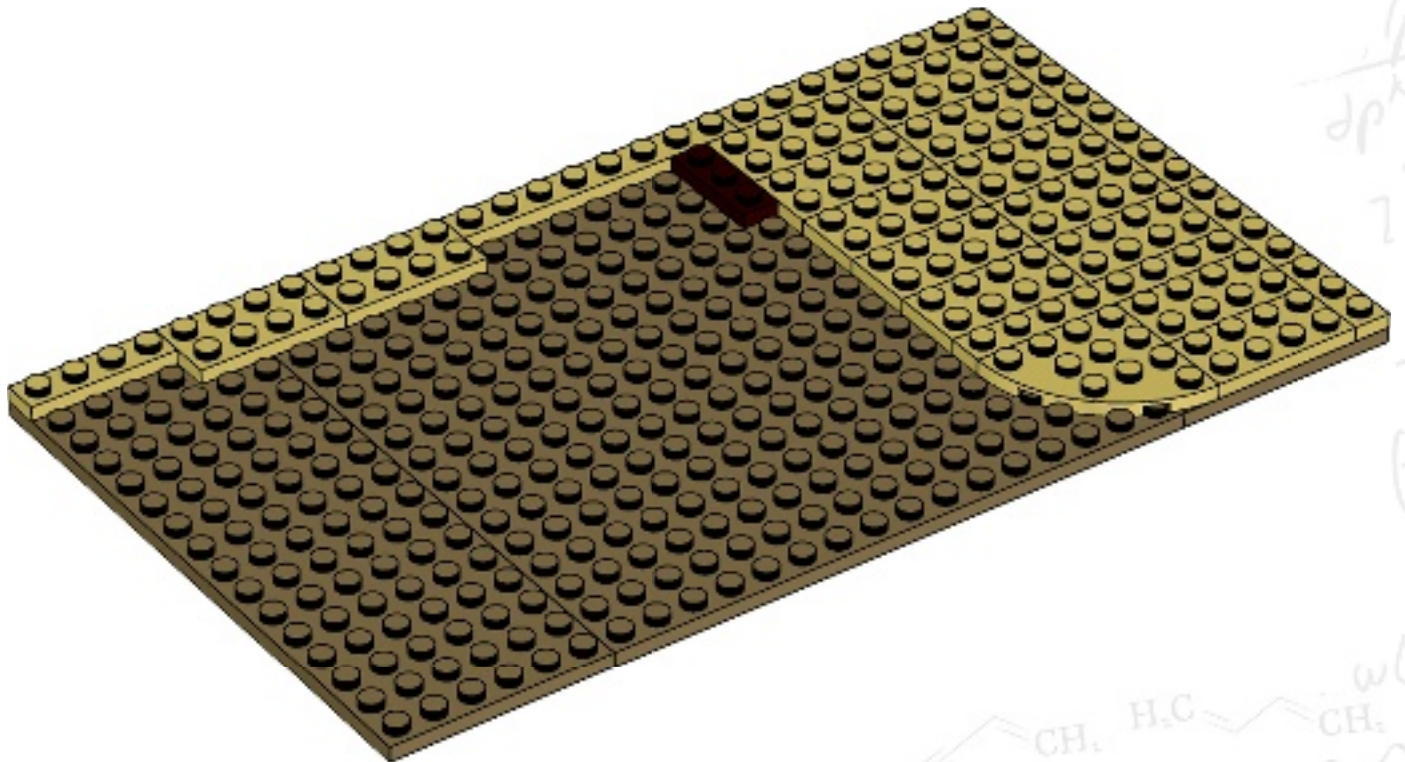

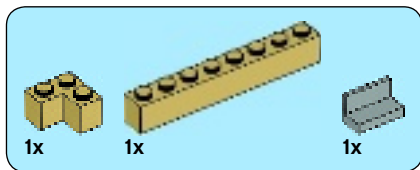

9

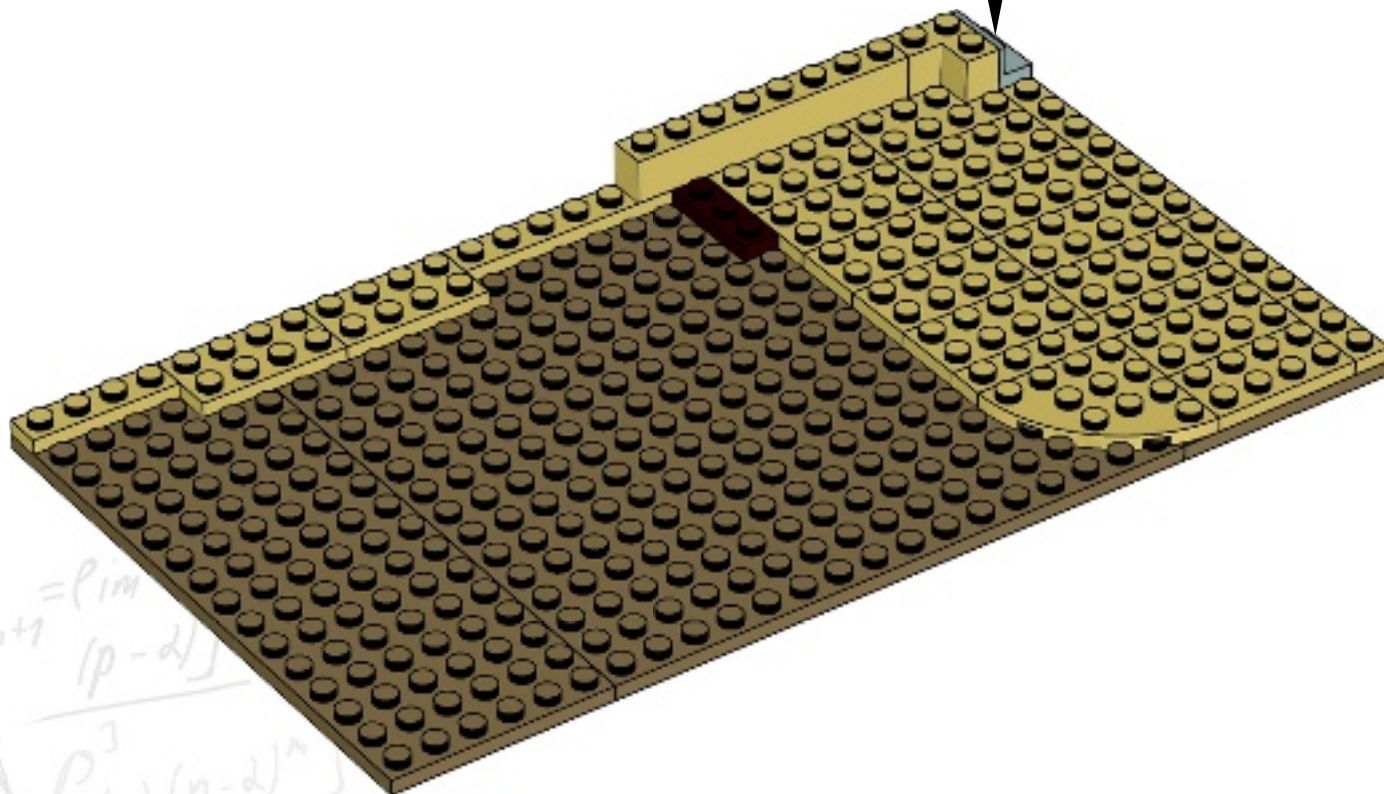
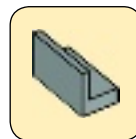

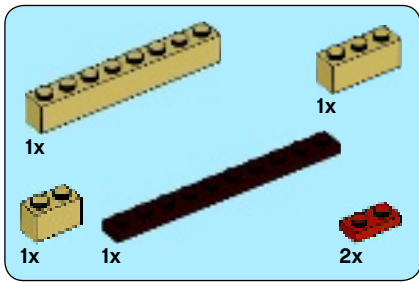

10

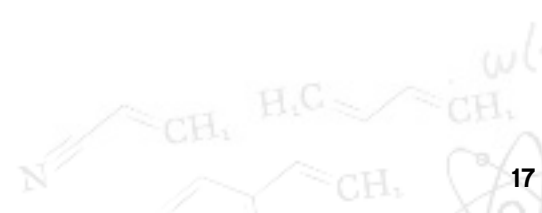
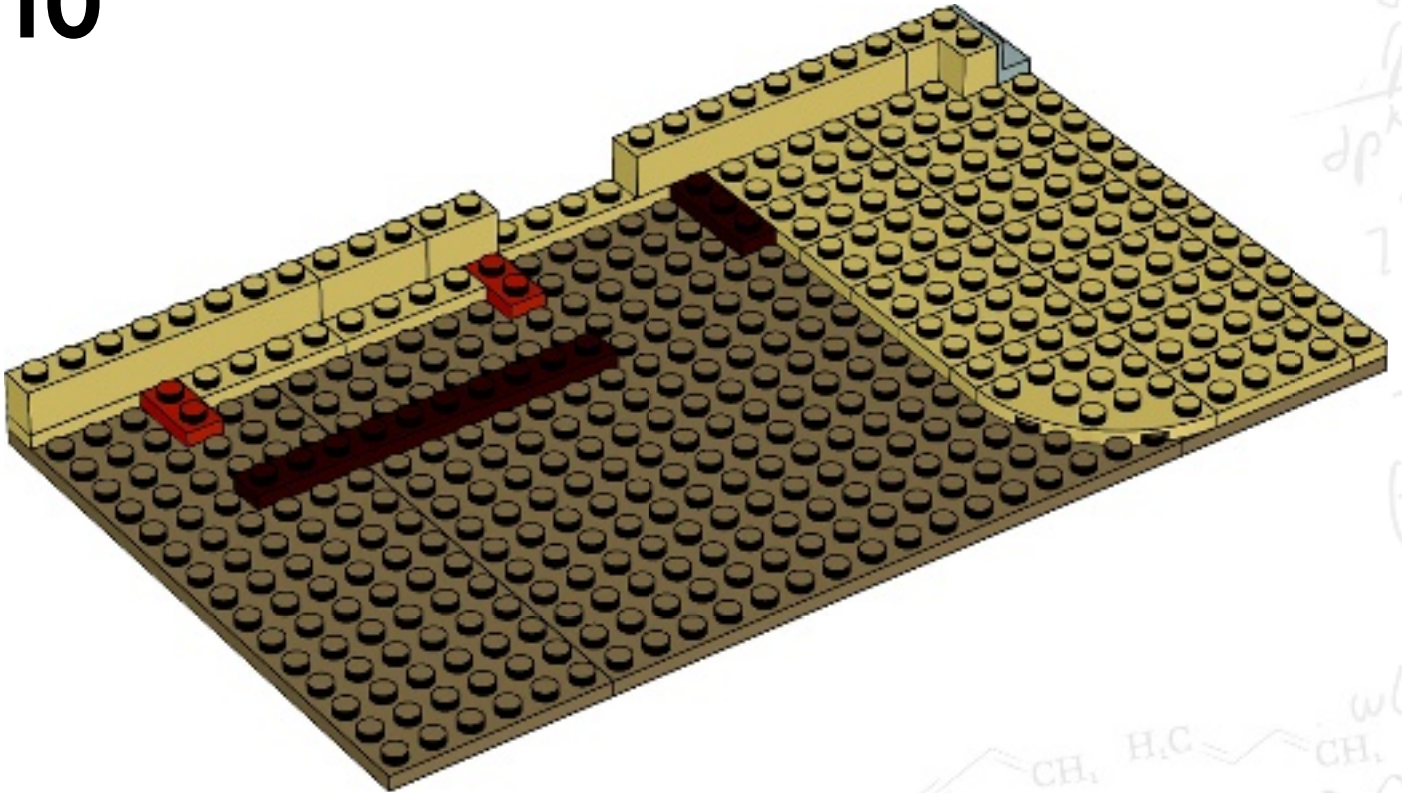



3x



1x

11

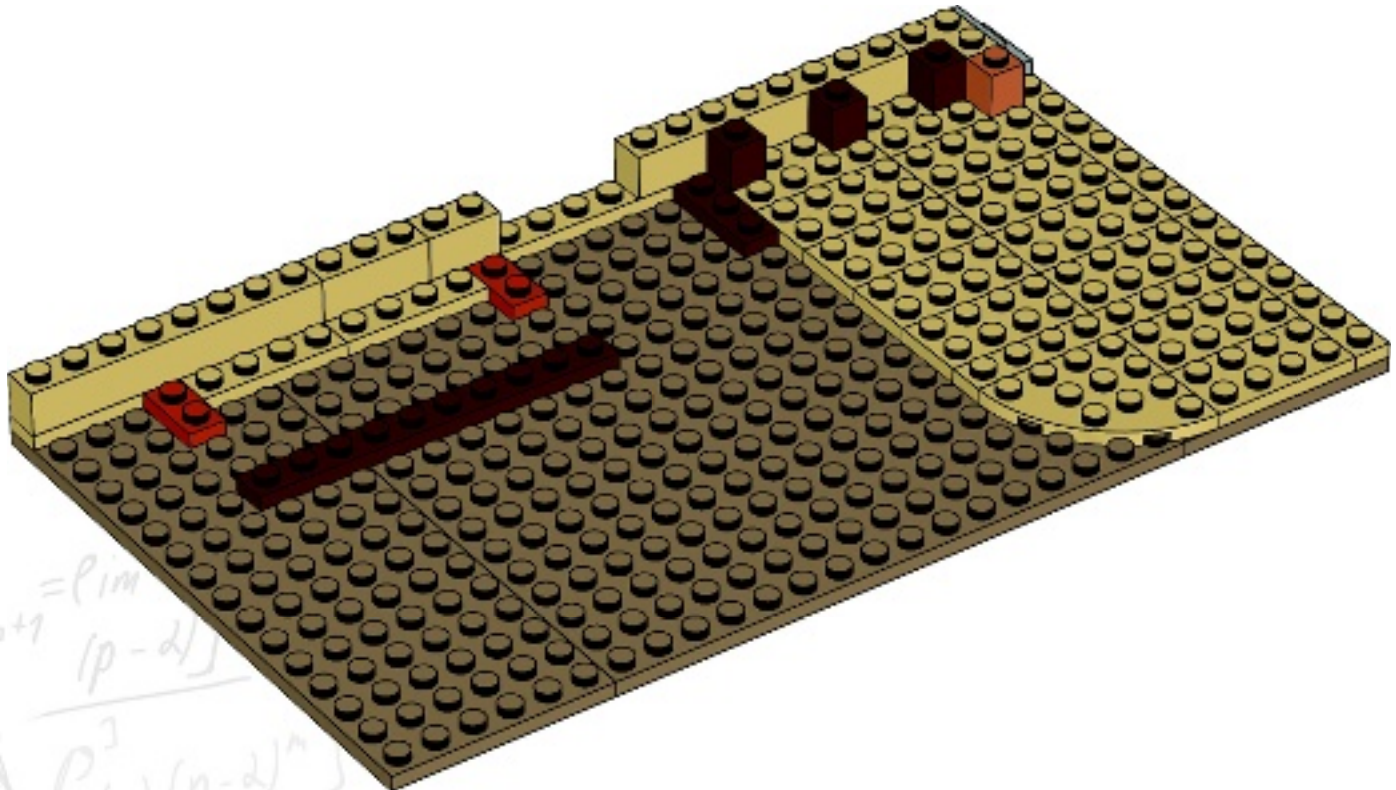

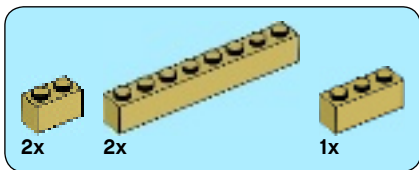

12

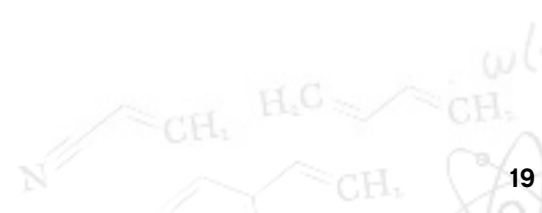
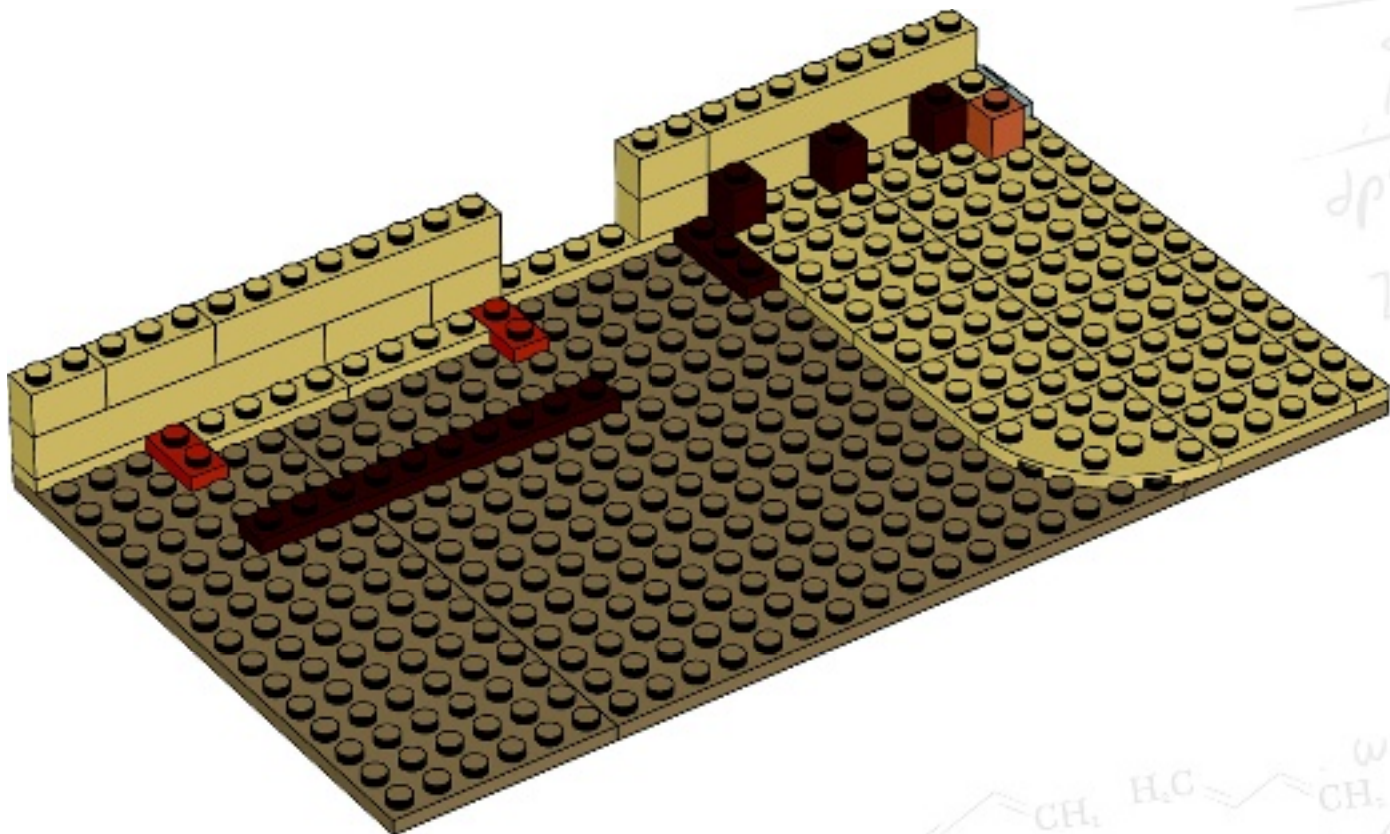



13

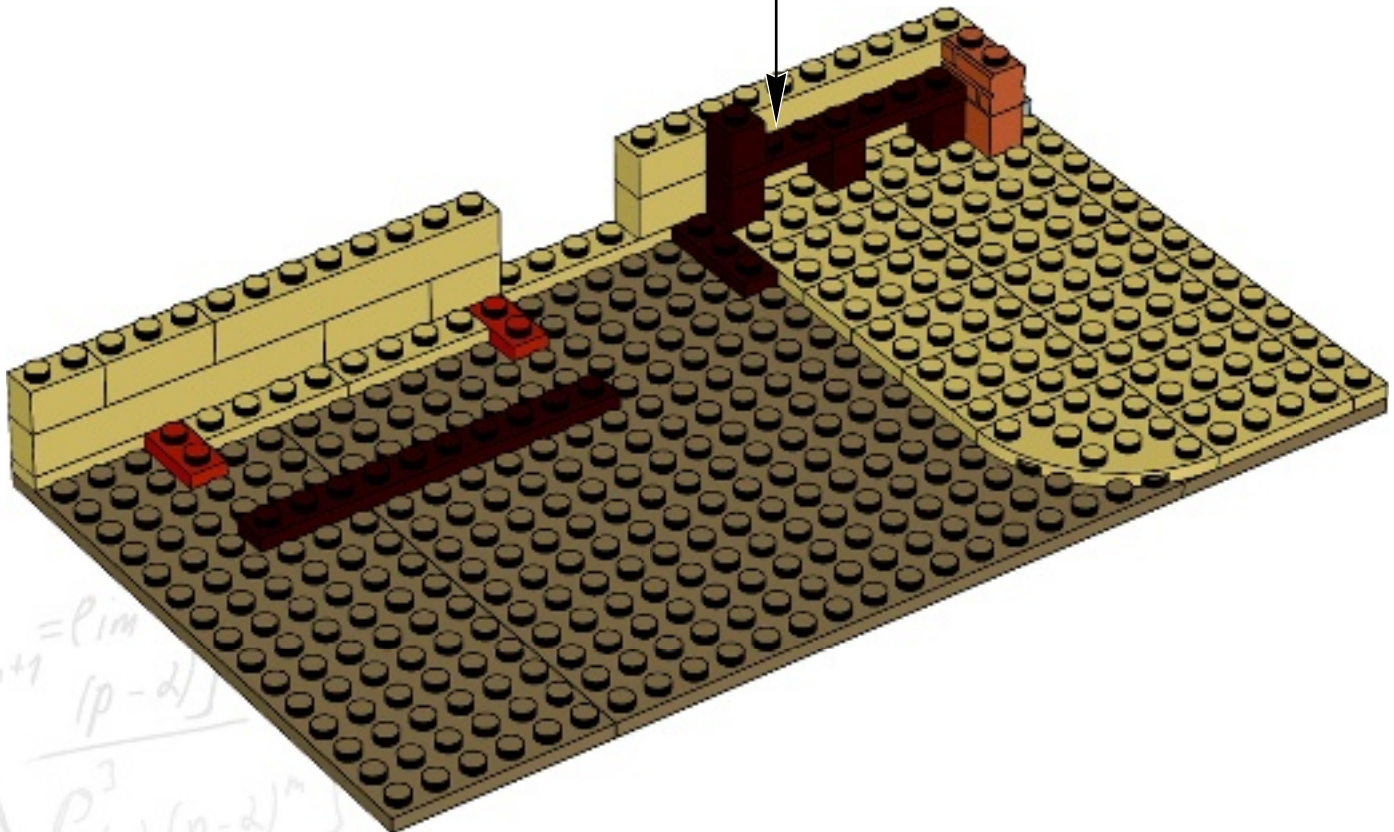
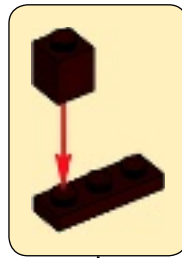

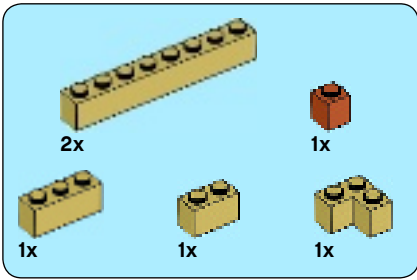

14

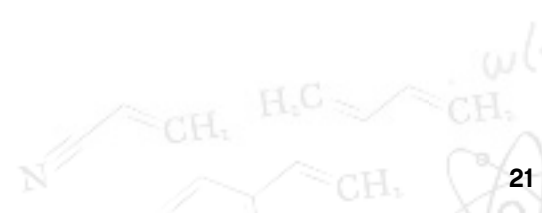
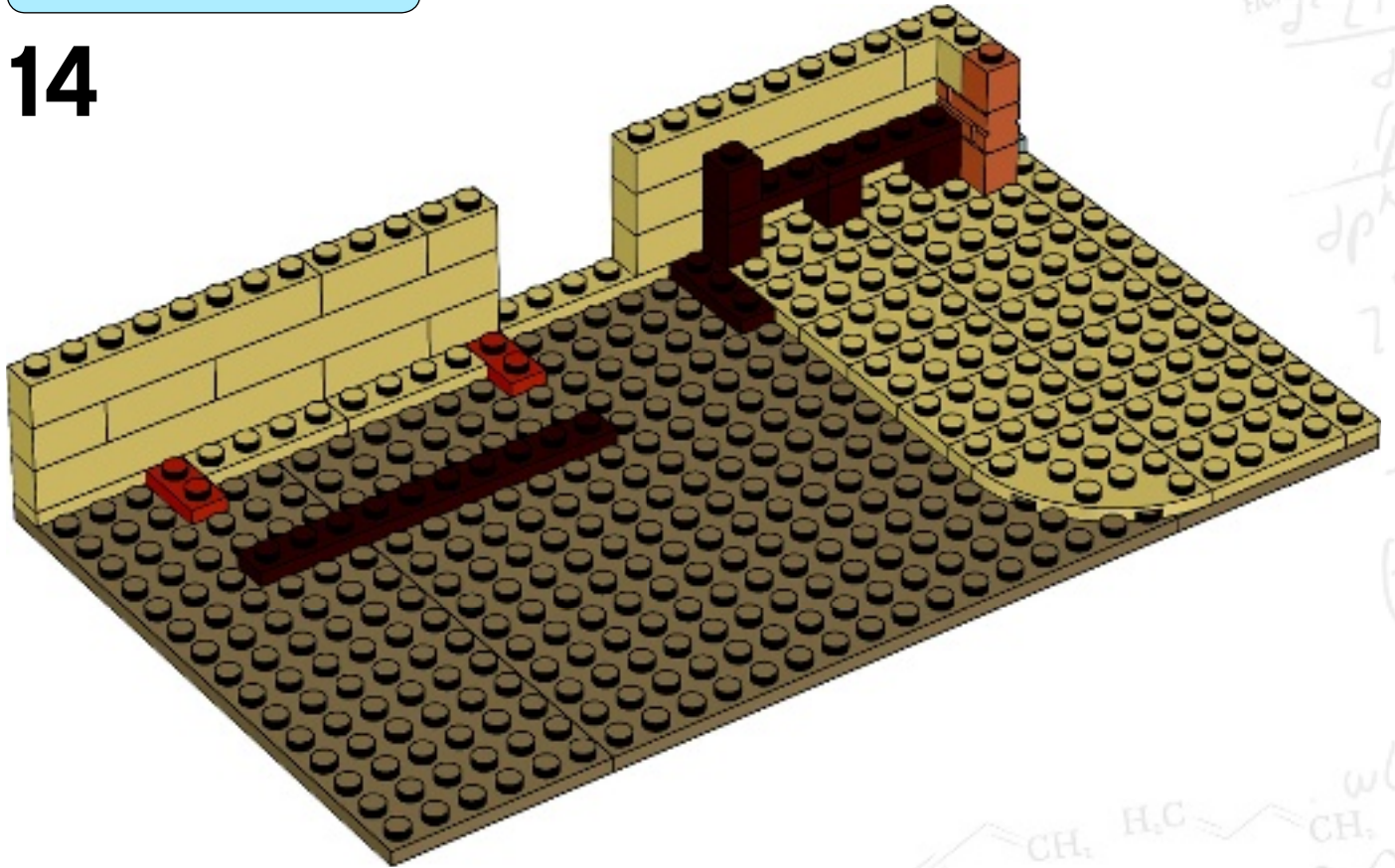

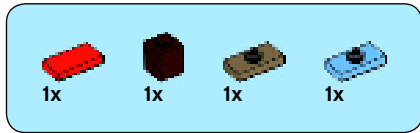

15

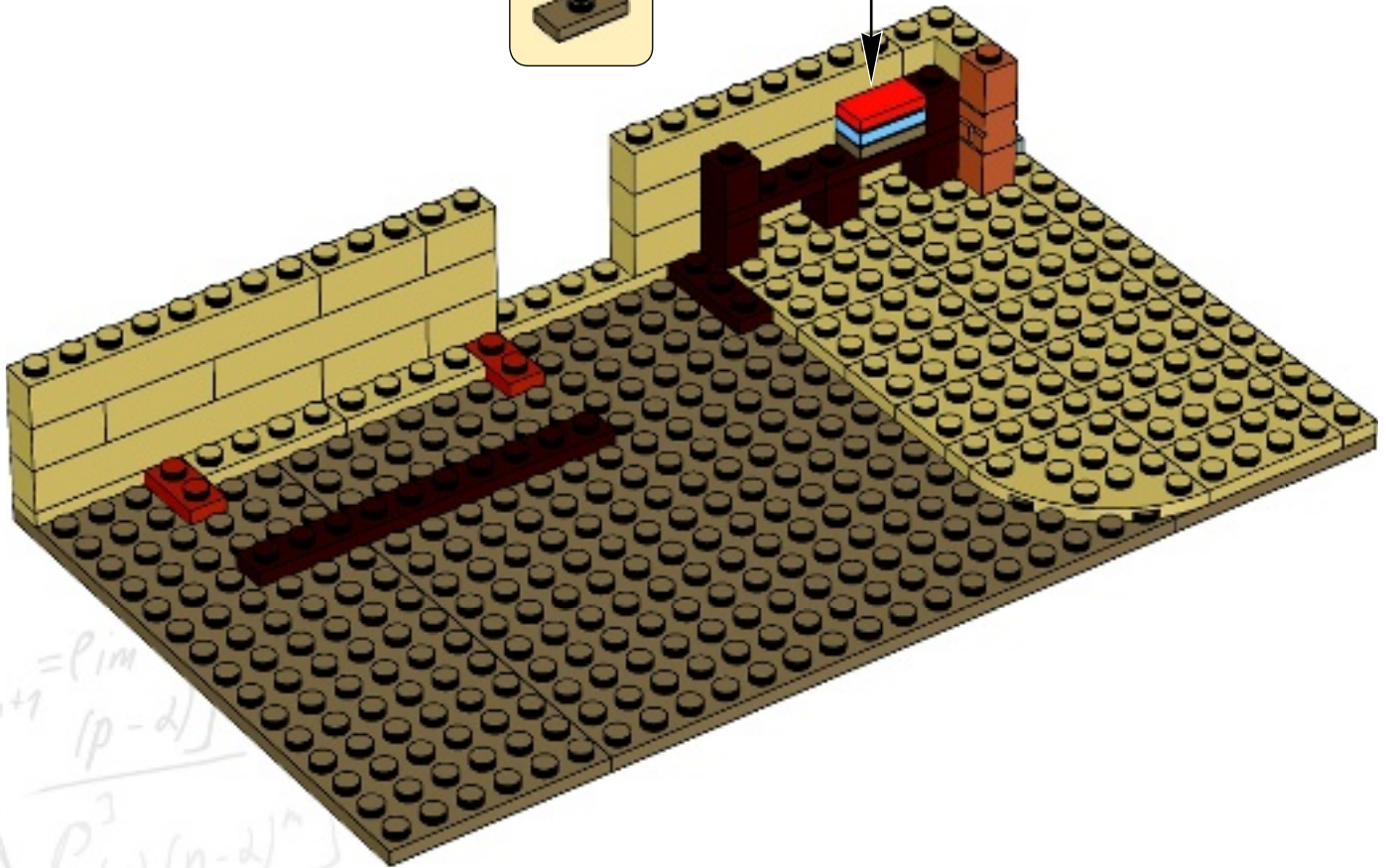
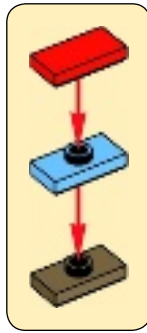

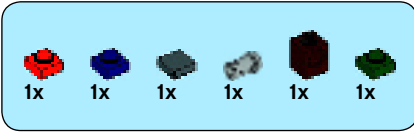

16

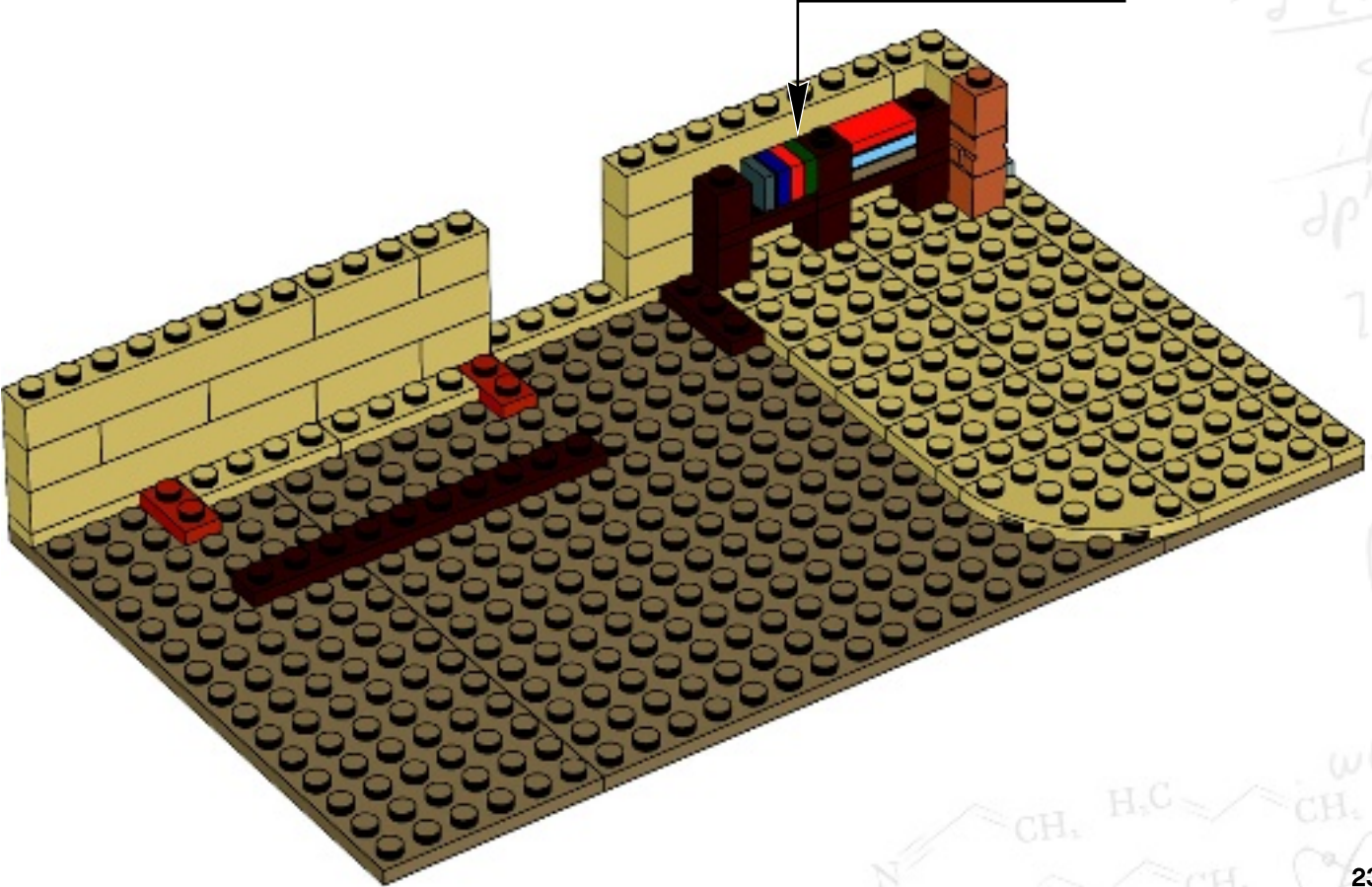
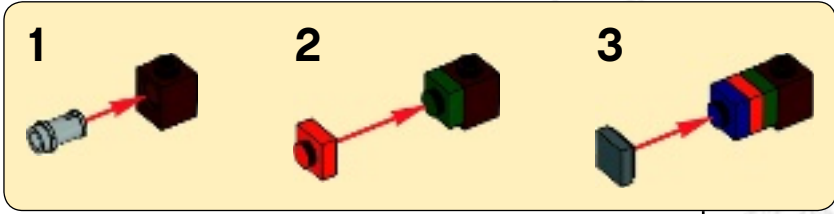



3x

17

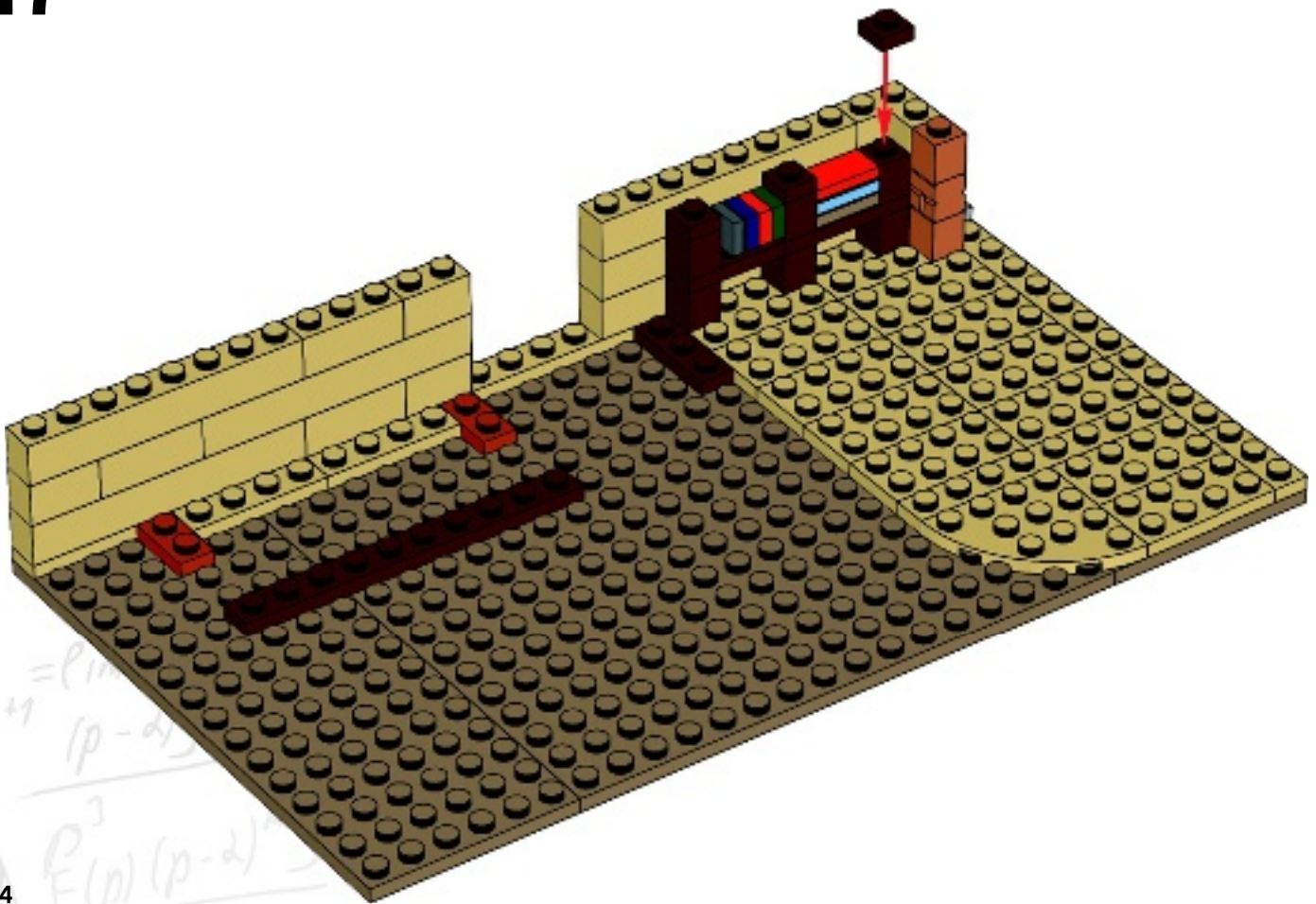



18

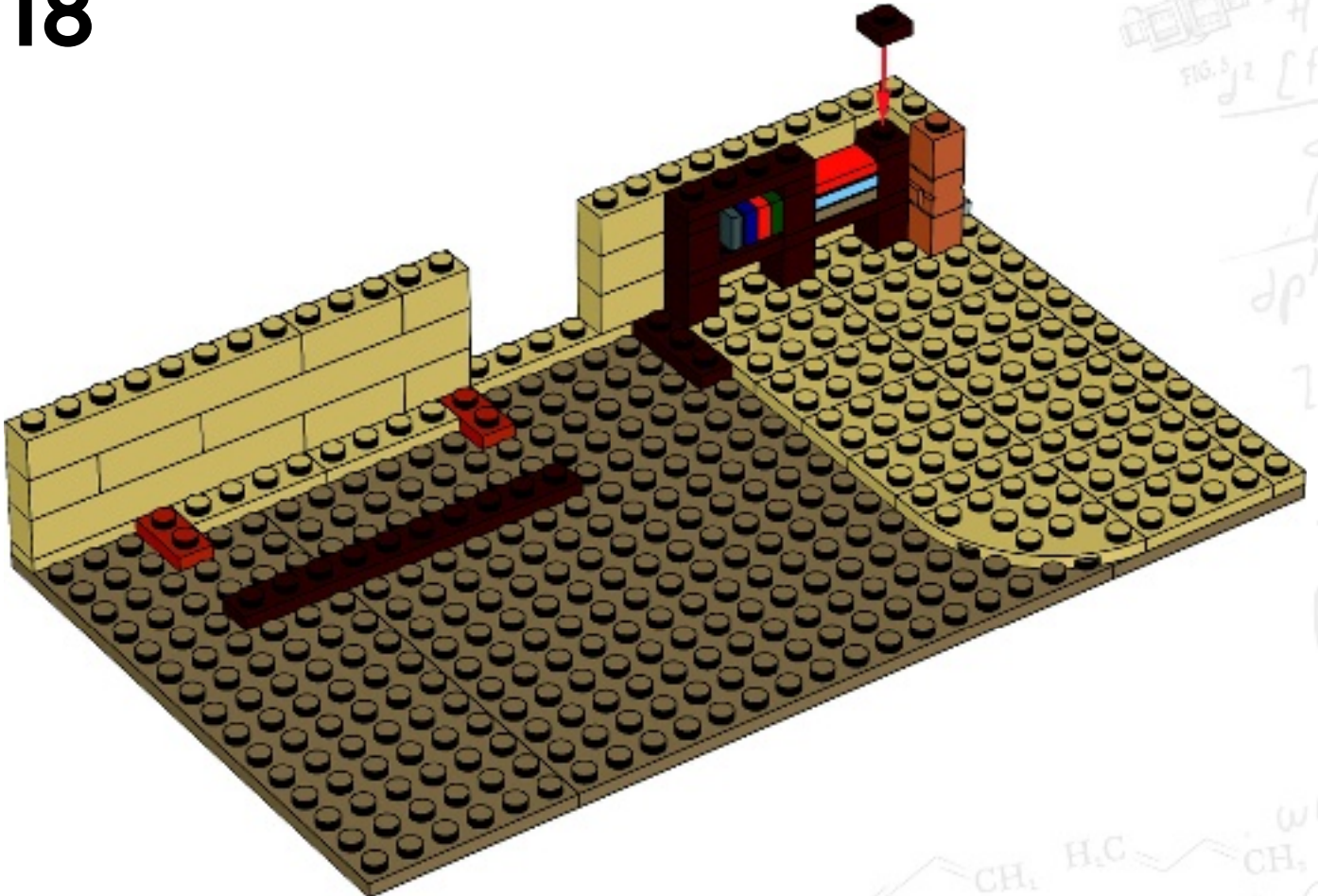

$(n-2)!$ γ $(-m + (-m+1)(p-q))$
 $L = l$
 $p =$
 $+$
 $FIG. 3$ $[f/p]$
 p
 p
 p
 $2p^{1+}$
 z
 (4)
 $\omega(d)$
 $N=$ CH_2 H_2C CH_2
 CH_2

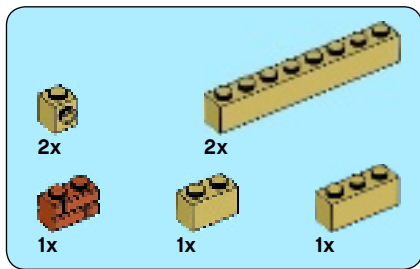

19

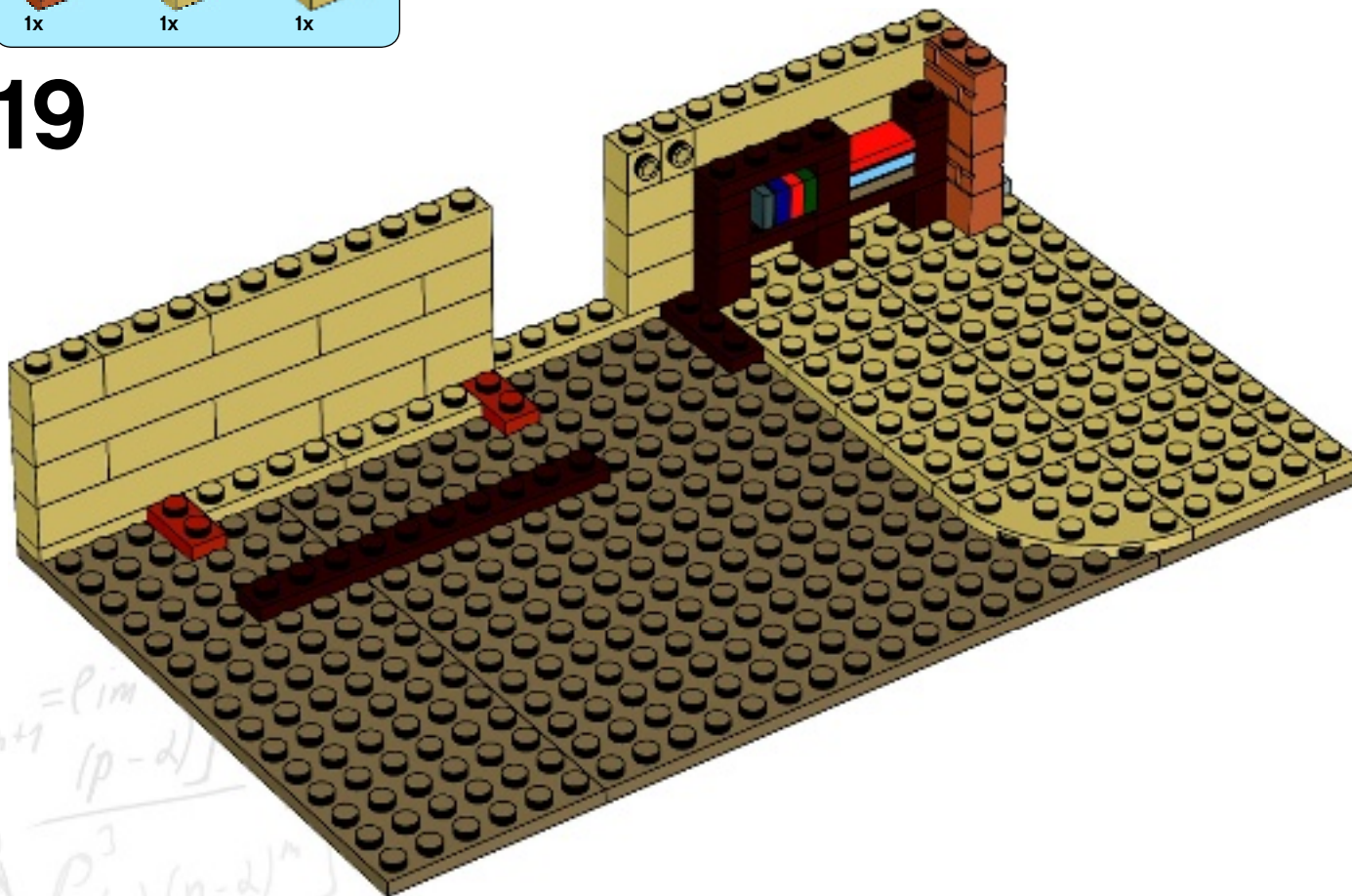

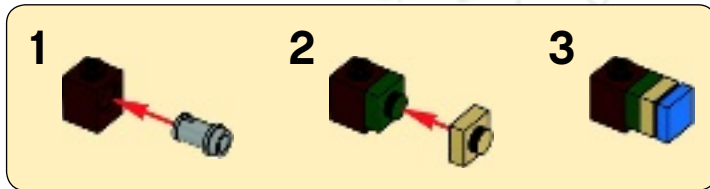
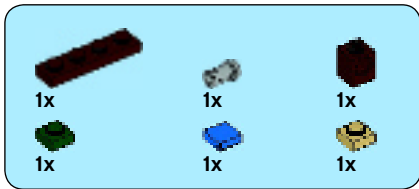



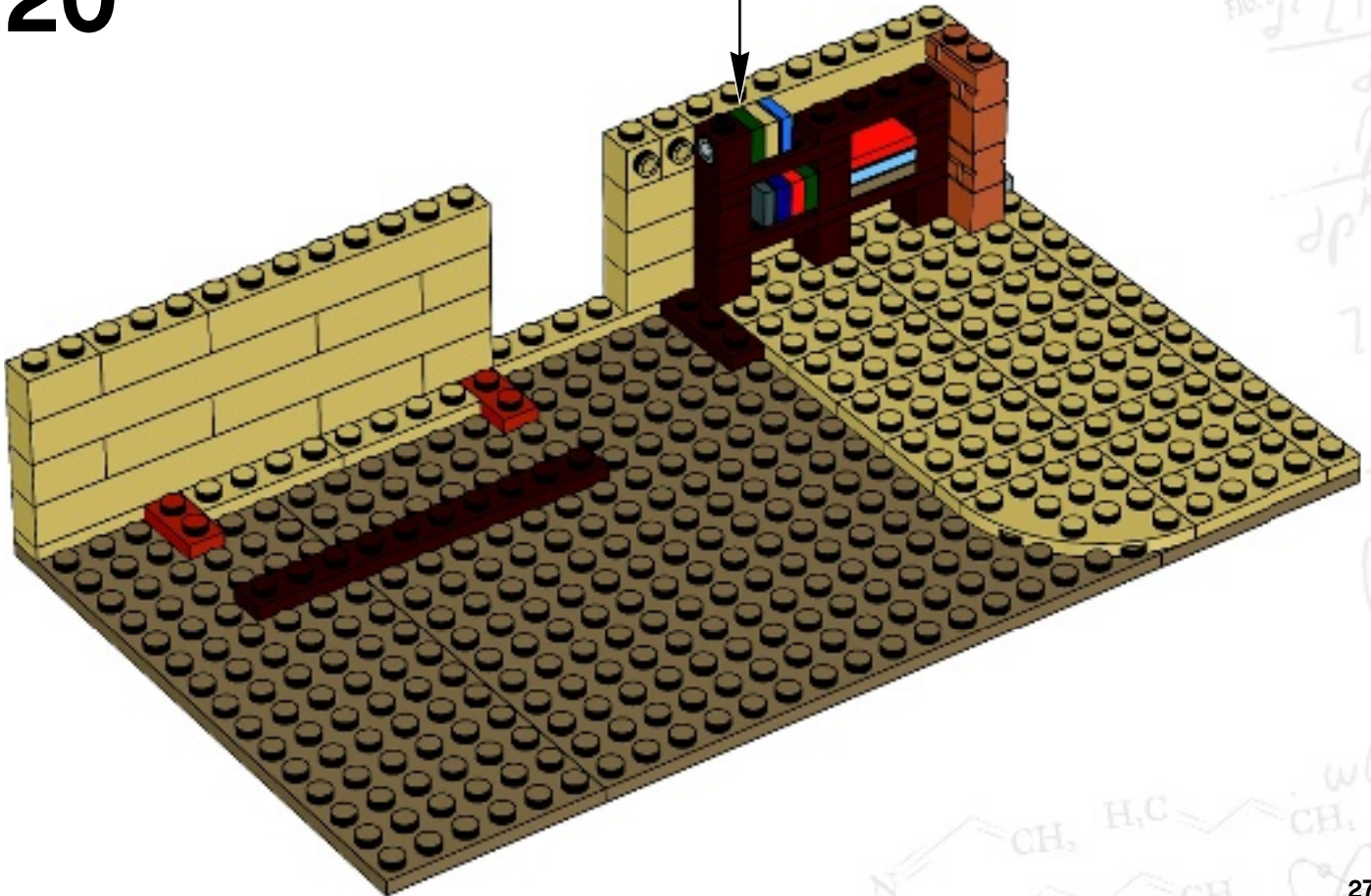

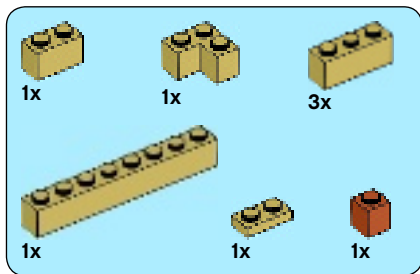
20



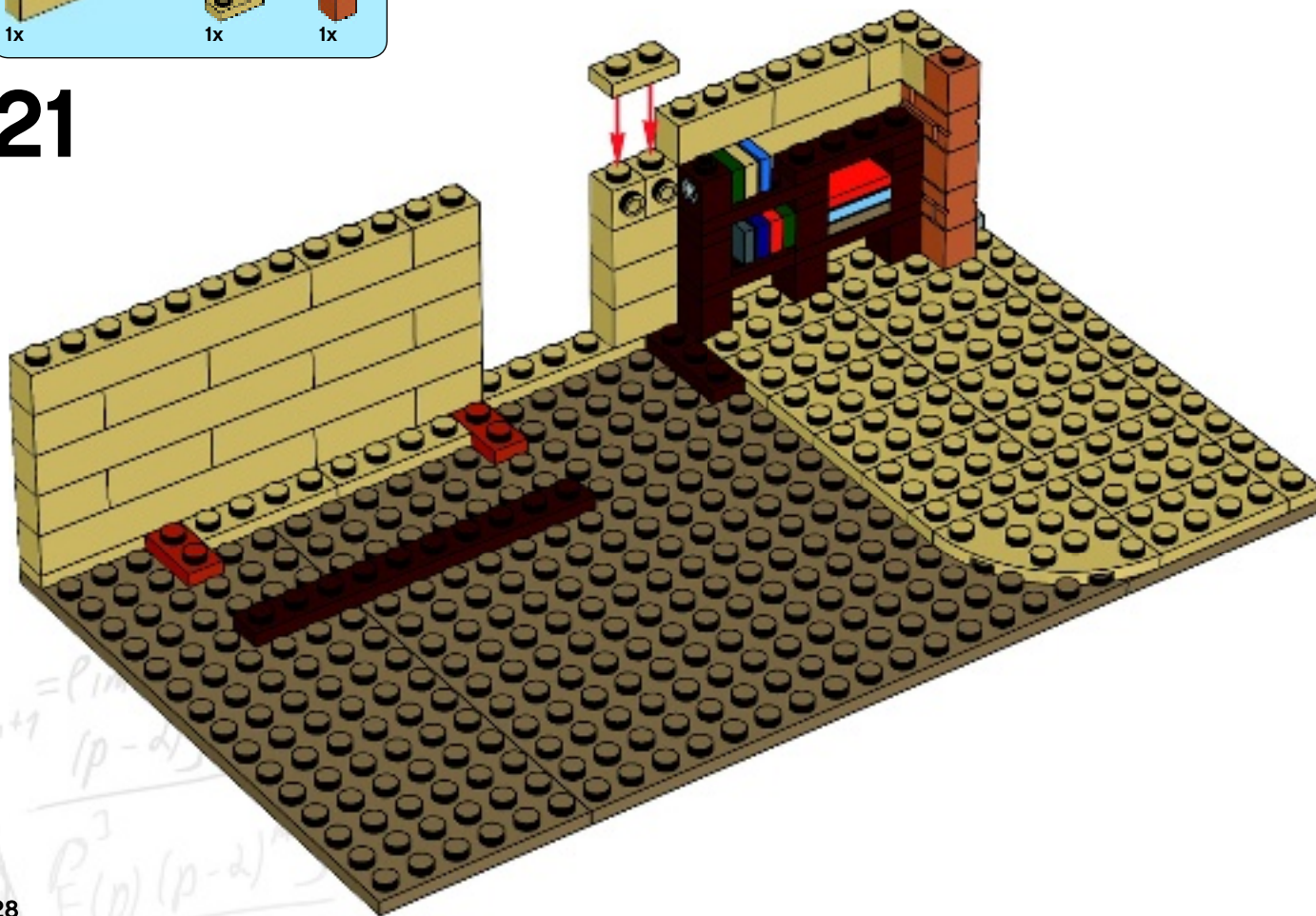

21



		
1x	2x	1x

22

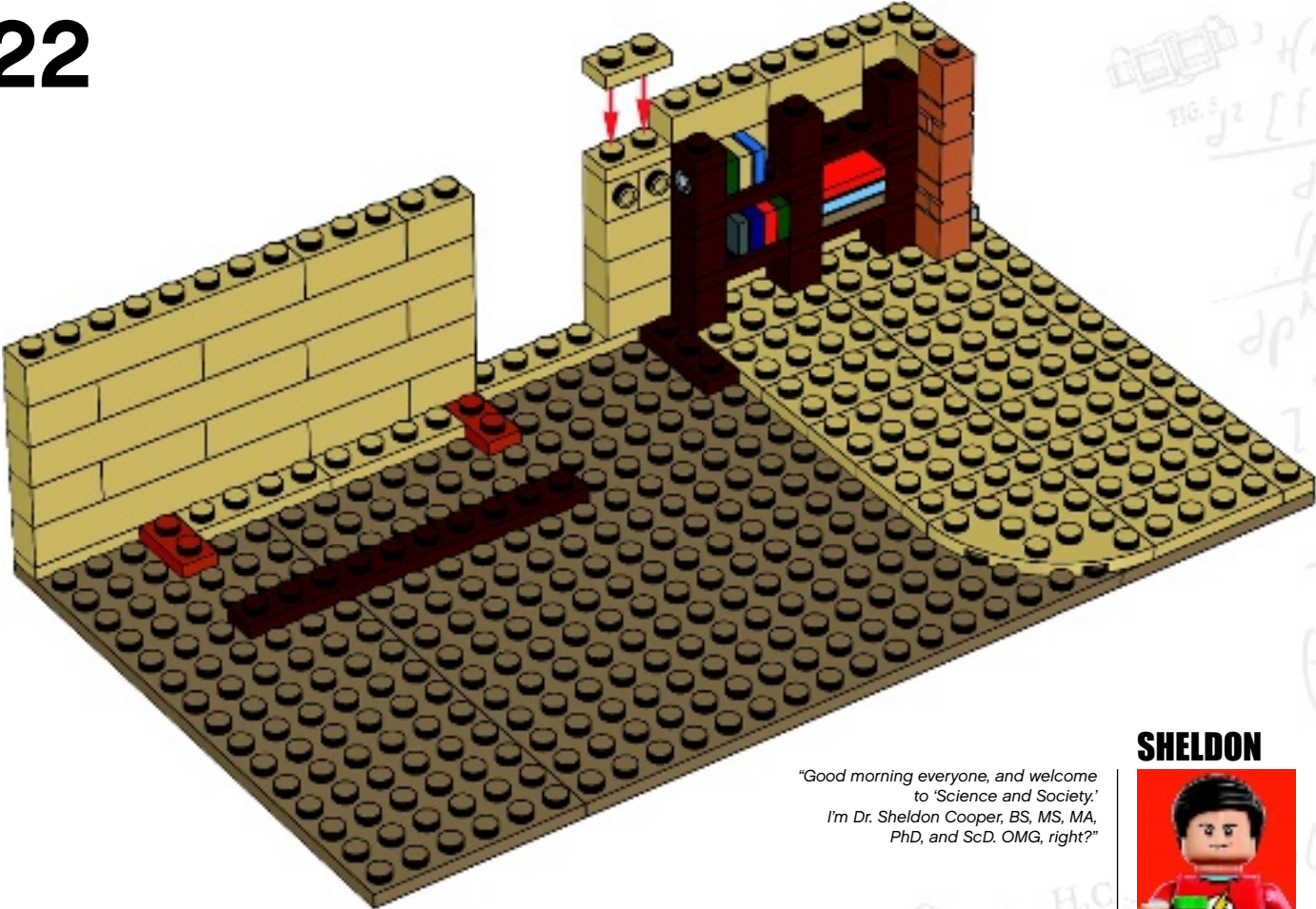

SHELDON

"Good morning everyone, and welcome to 'Science and Society.' I'm Dr. Sheldon Cooper, BS, MS, MA, PhD, and ScD. OMG, right?"





23

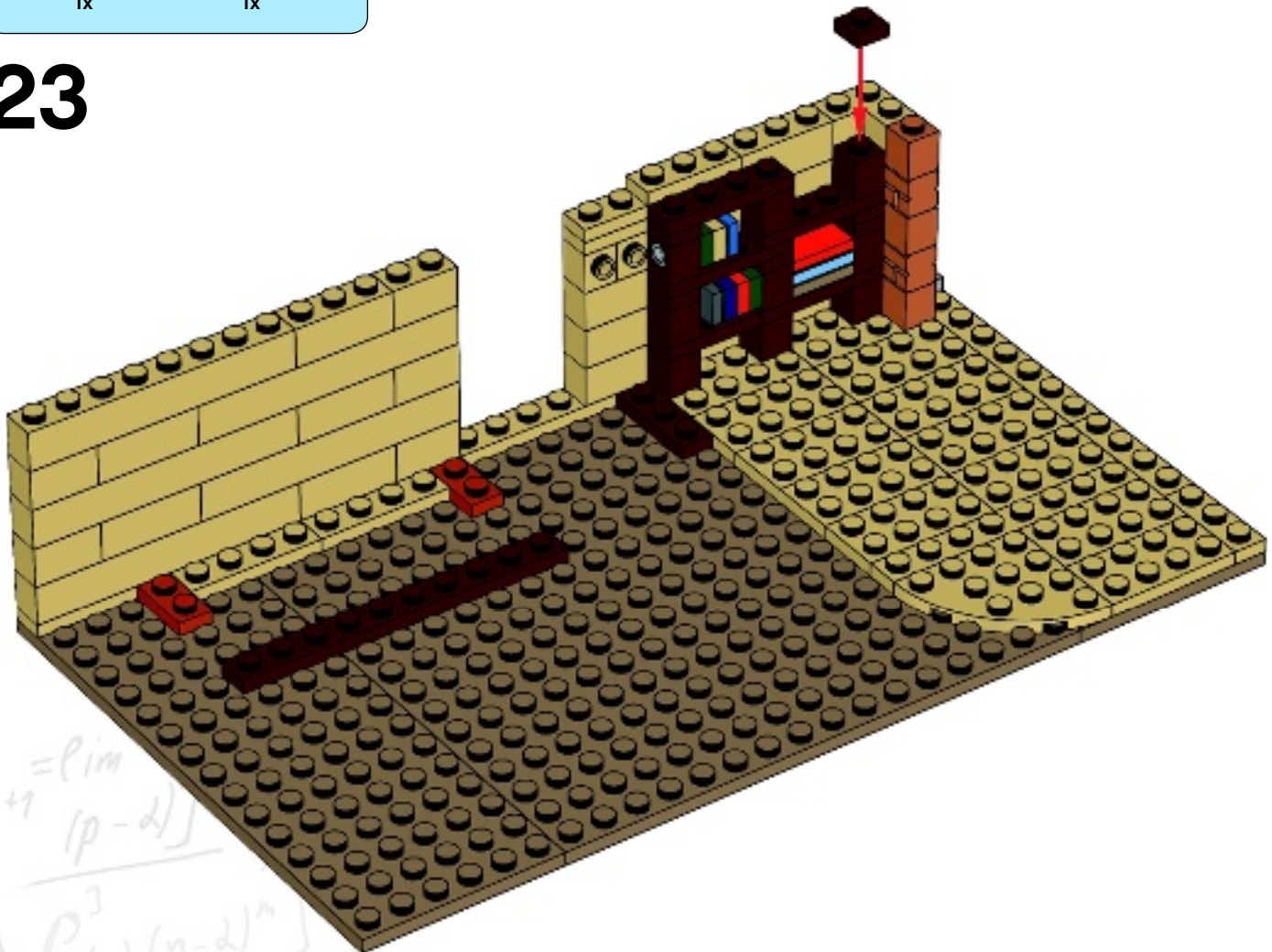

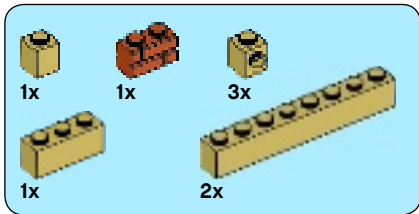

24

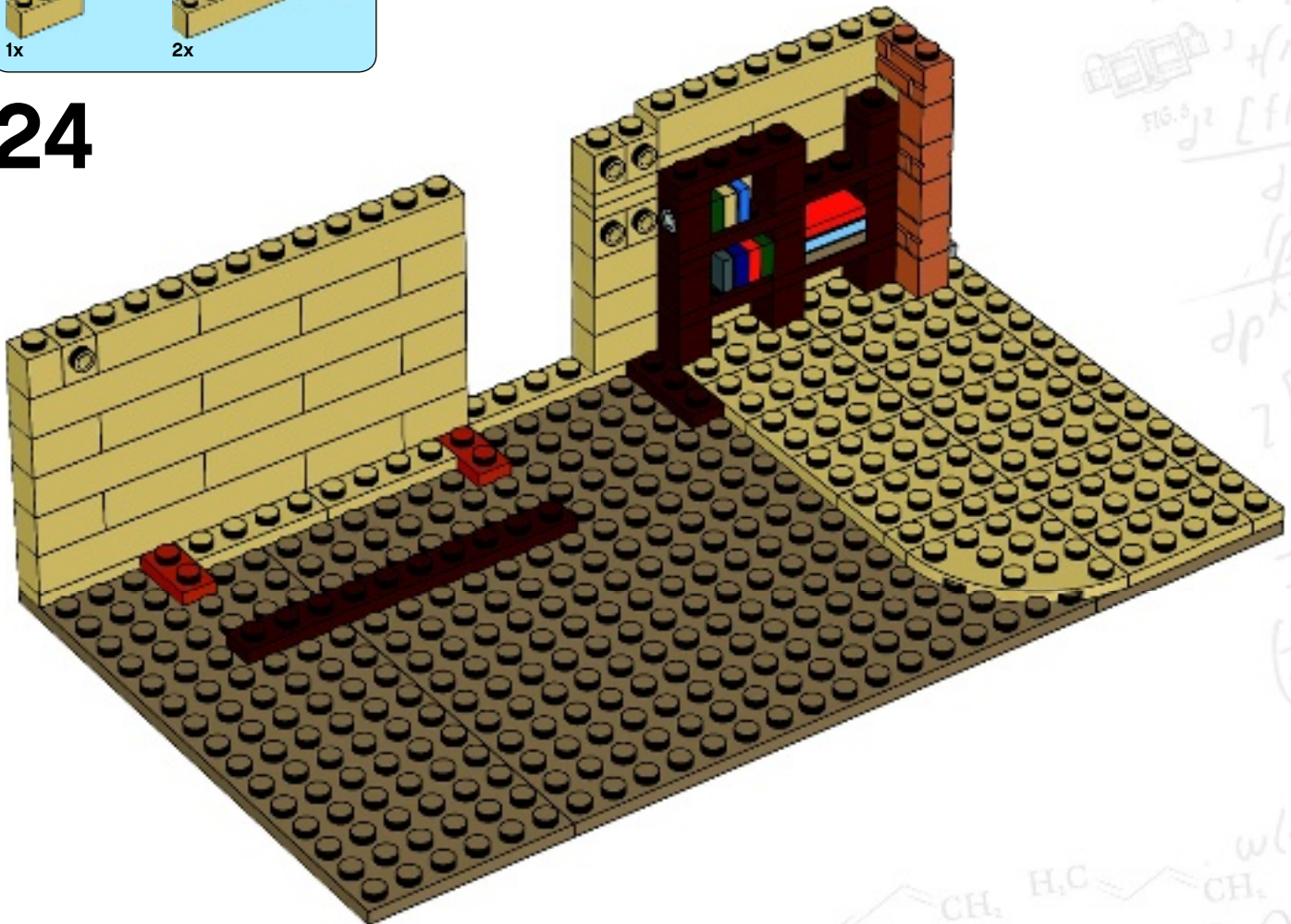

$(n-2)!$
 $(-m + (-m+1)(p-q) + \dots)$
 $L = m p^2$
FIG. 5
 $[f/p]$
 p/p
 p/p
 p/p
 $2[$
 (4)
 $w(d)$
 $N=CH_2$
 $H_2C=CH_2$
 CH_2
 CH_2

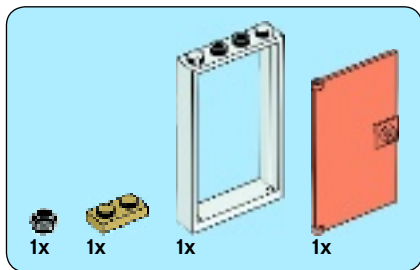

25

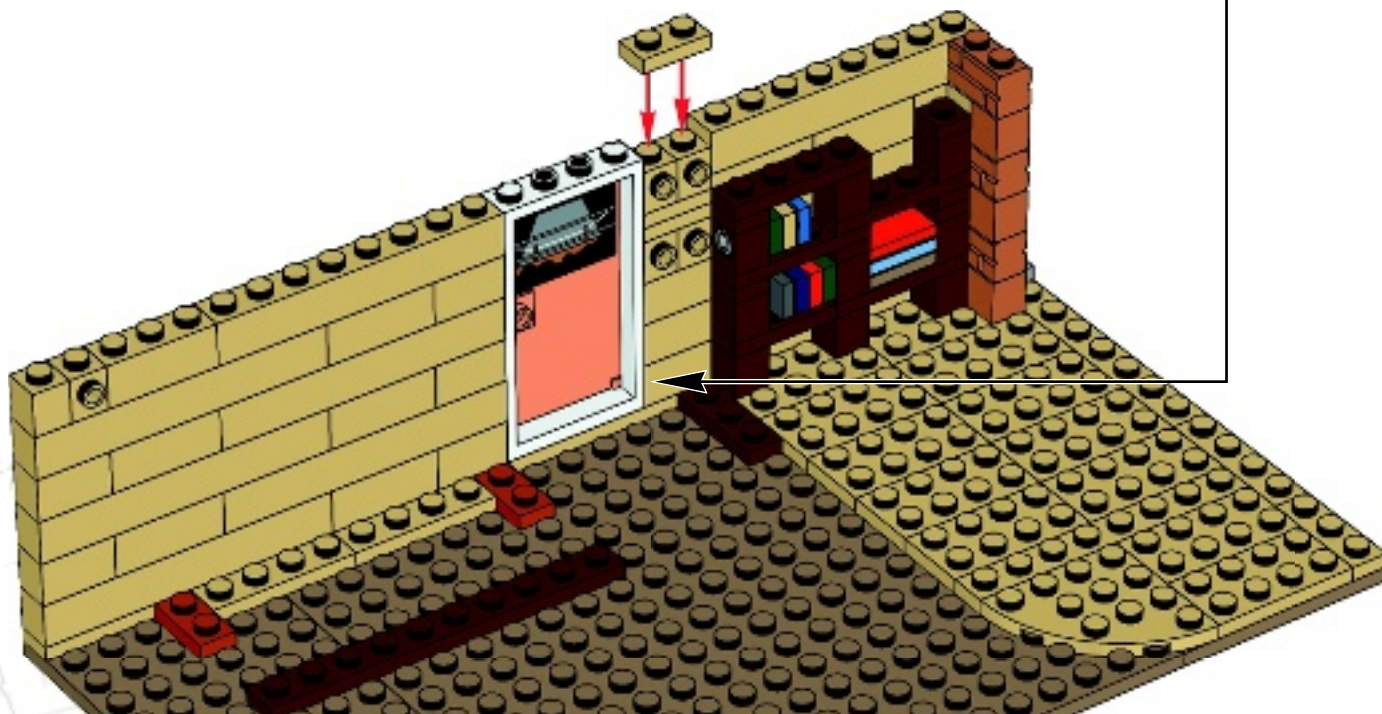
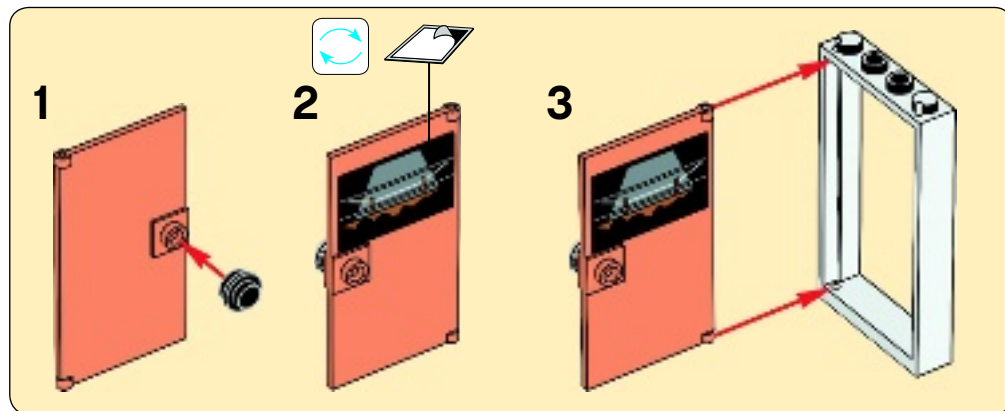



26

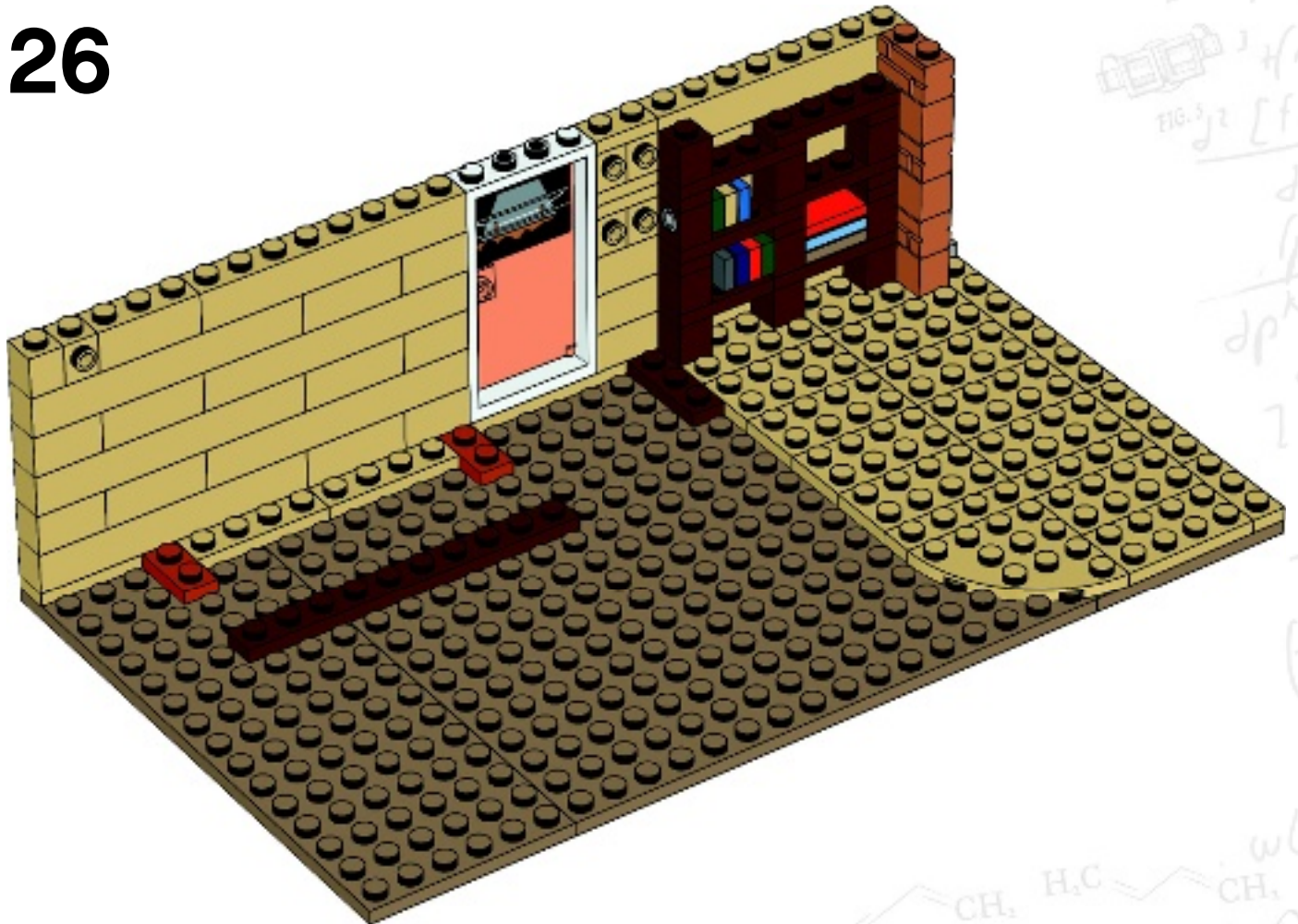

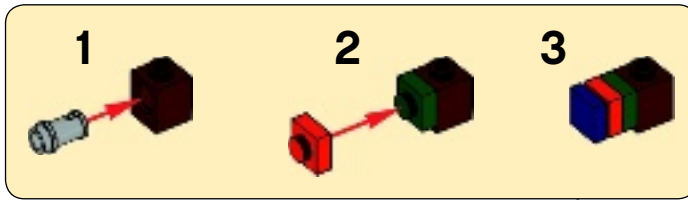
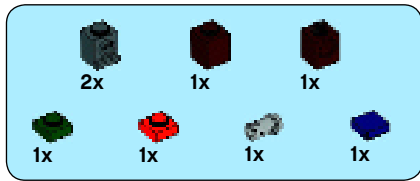

27

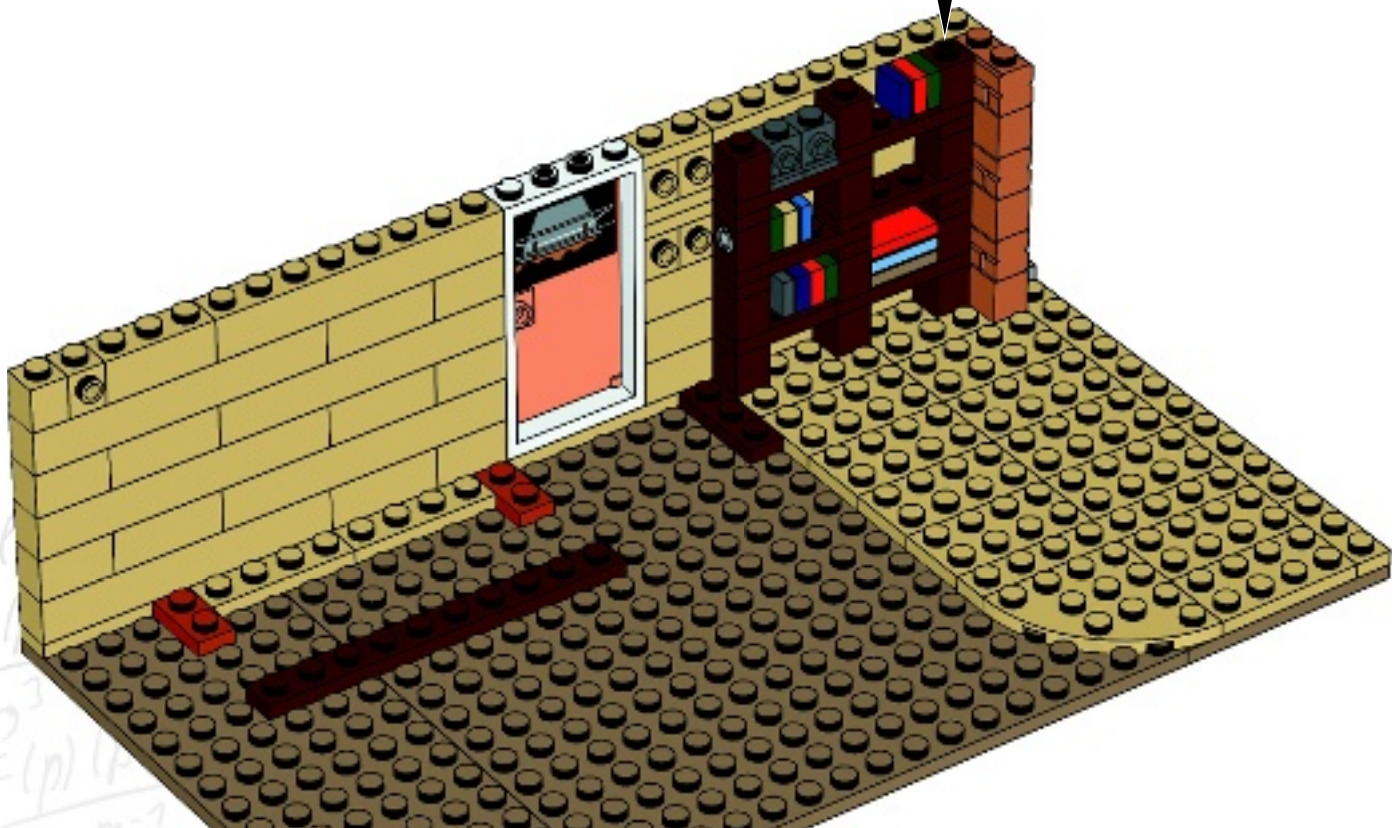

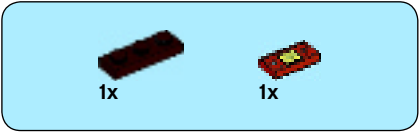

28

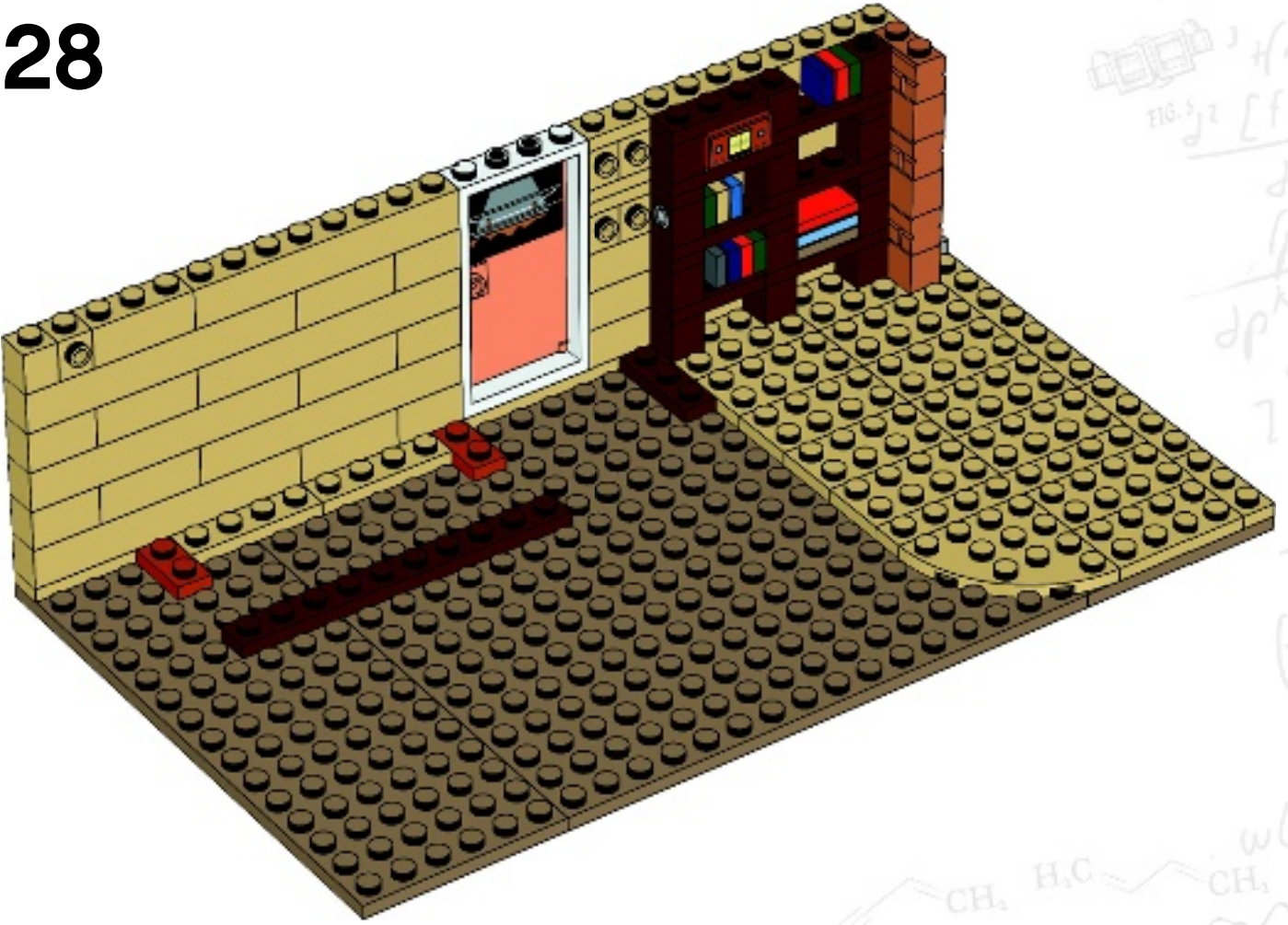

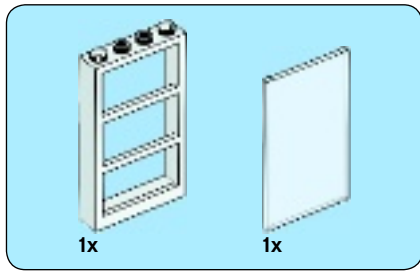

29

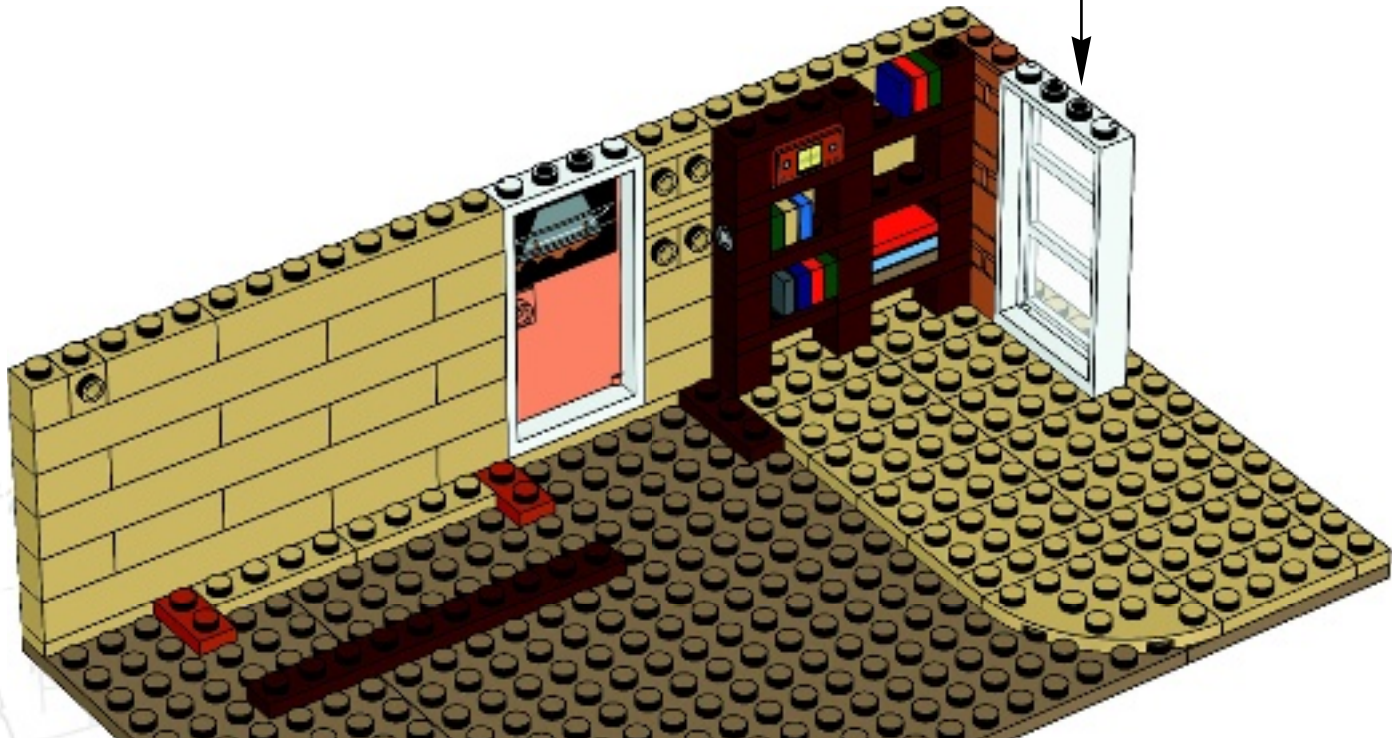
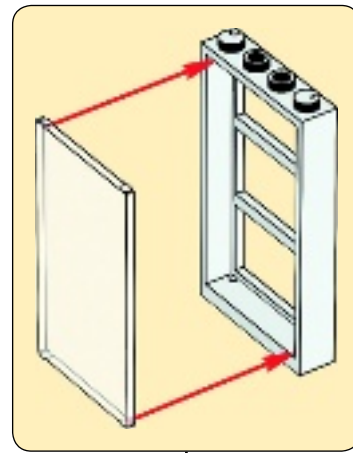



30

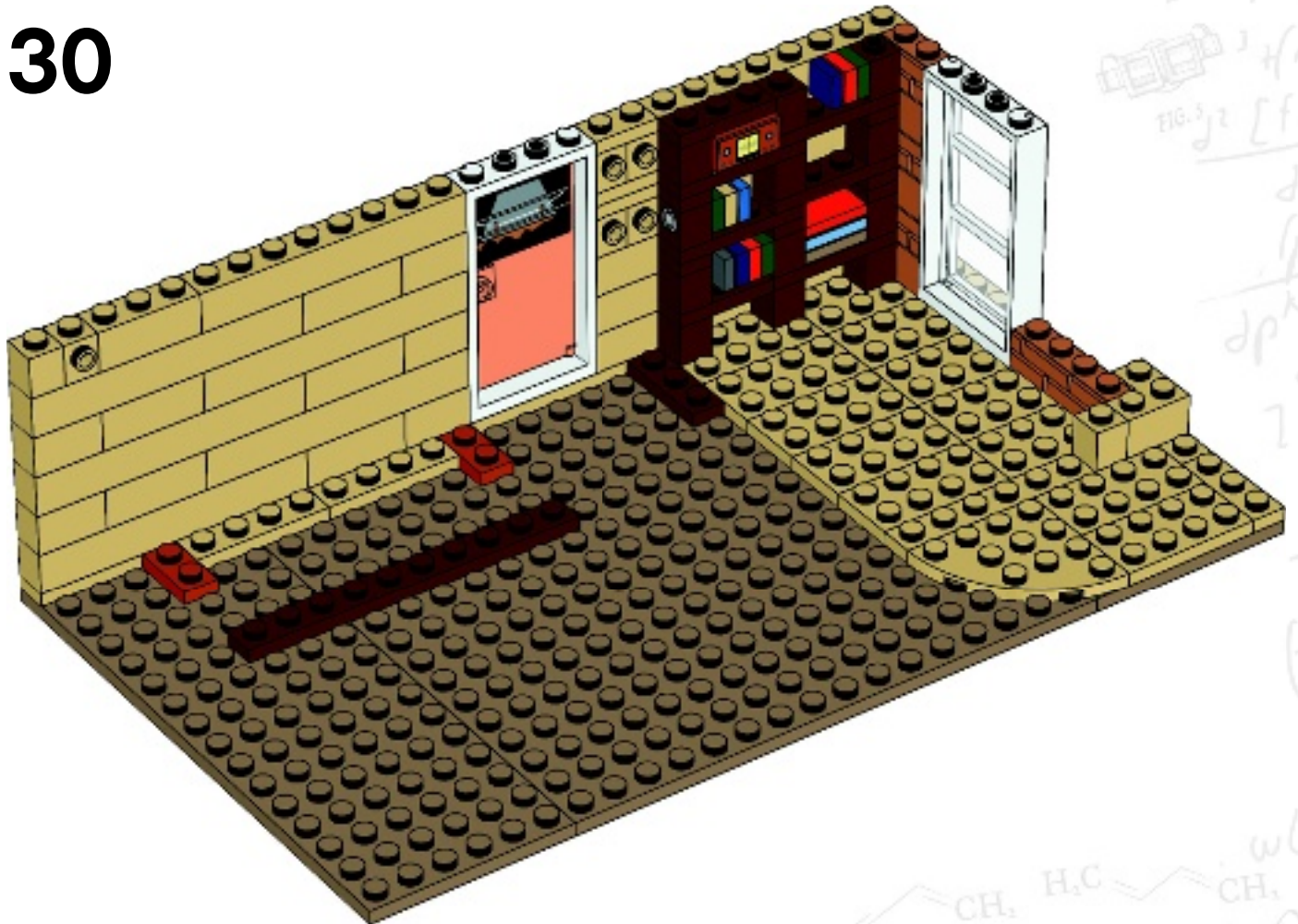



1x



2x



1x

31

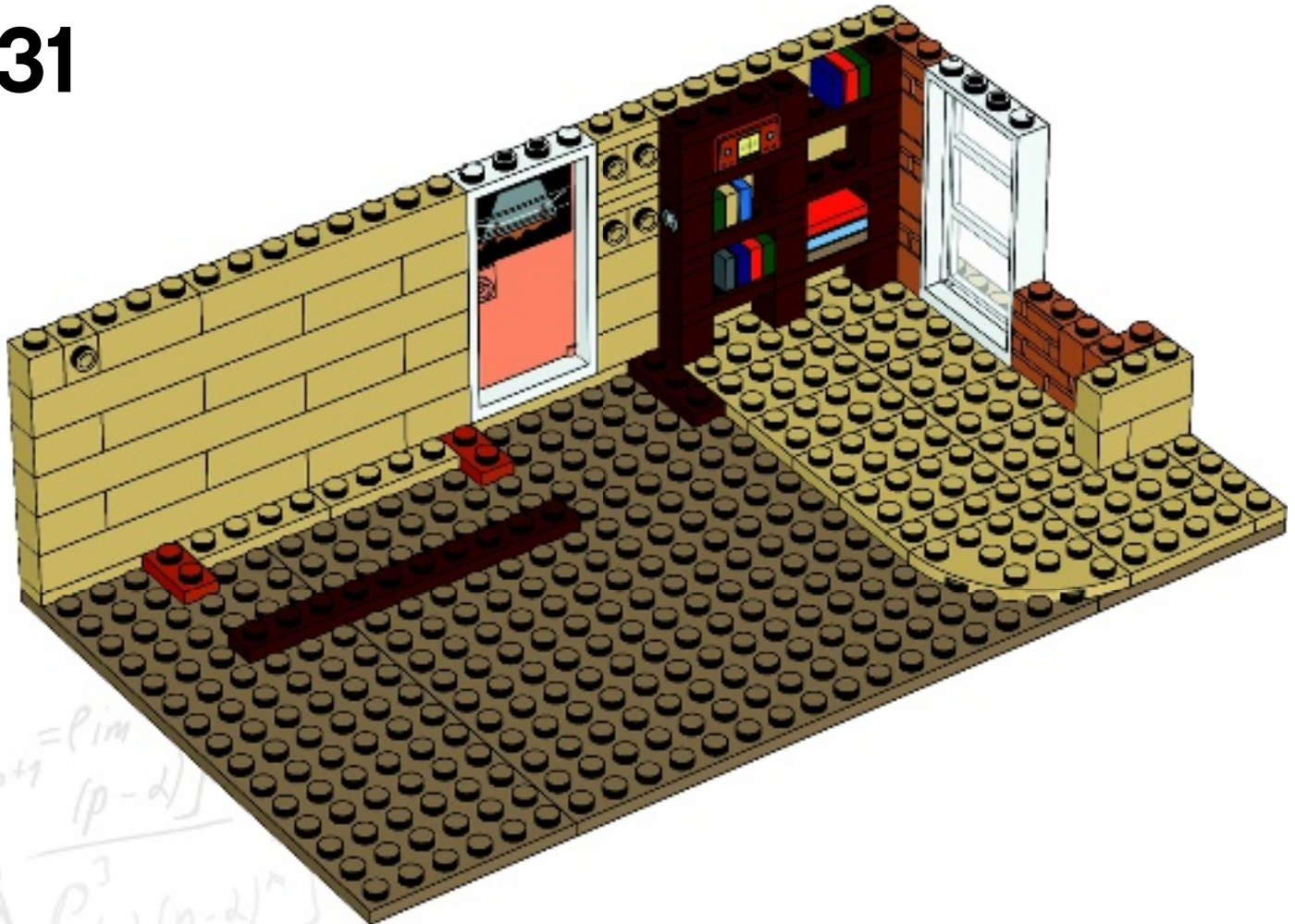

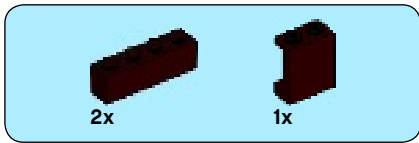

32

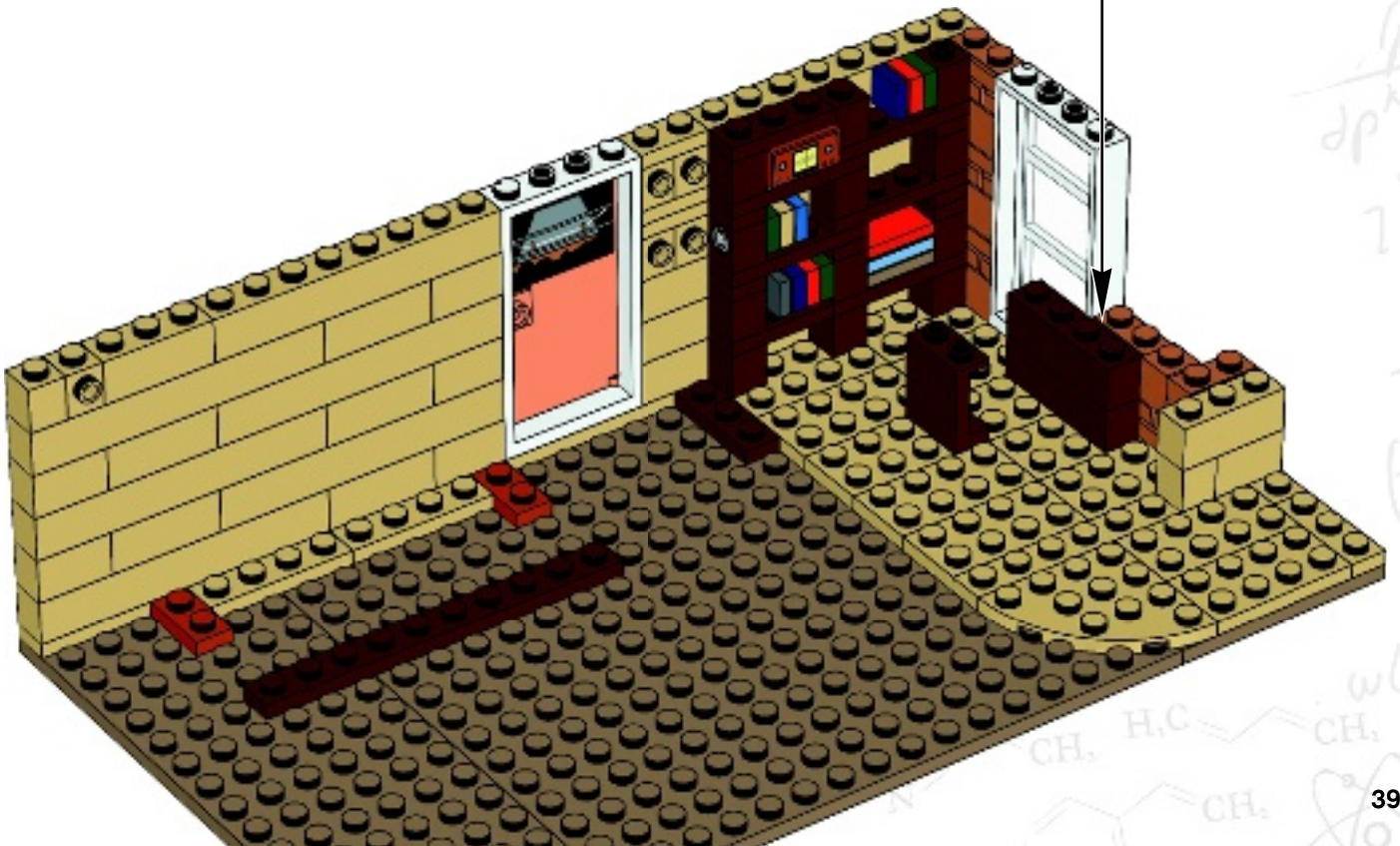
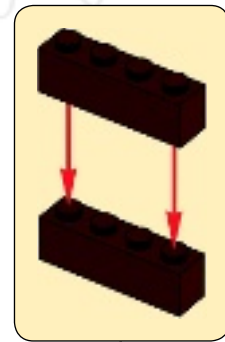

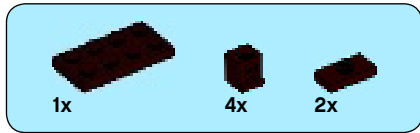

33

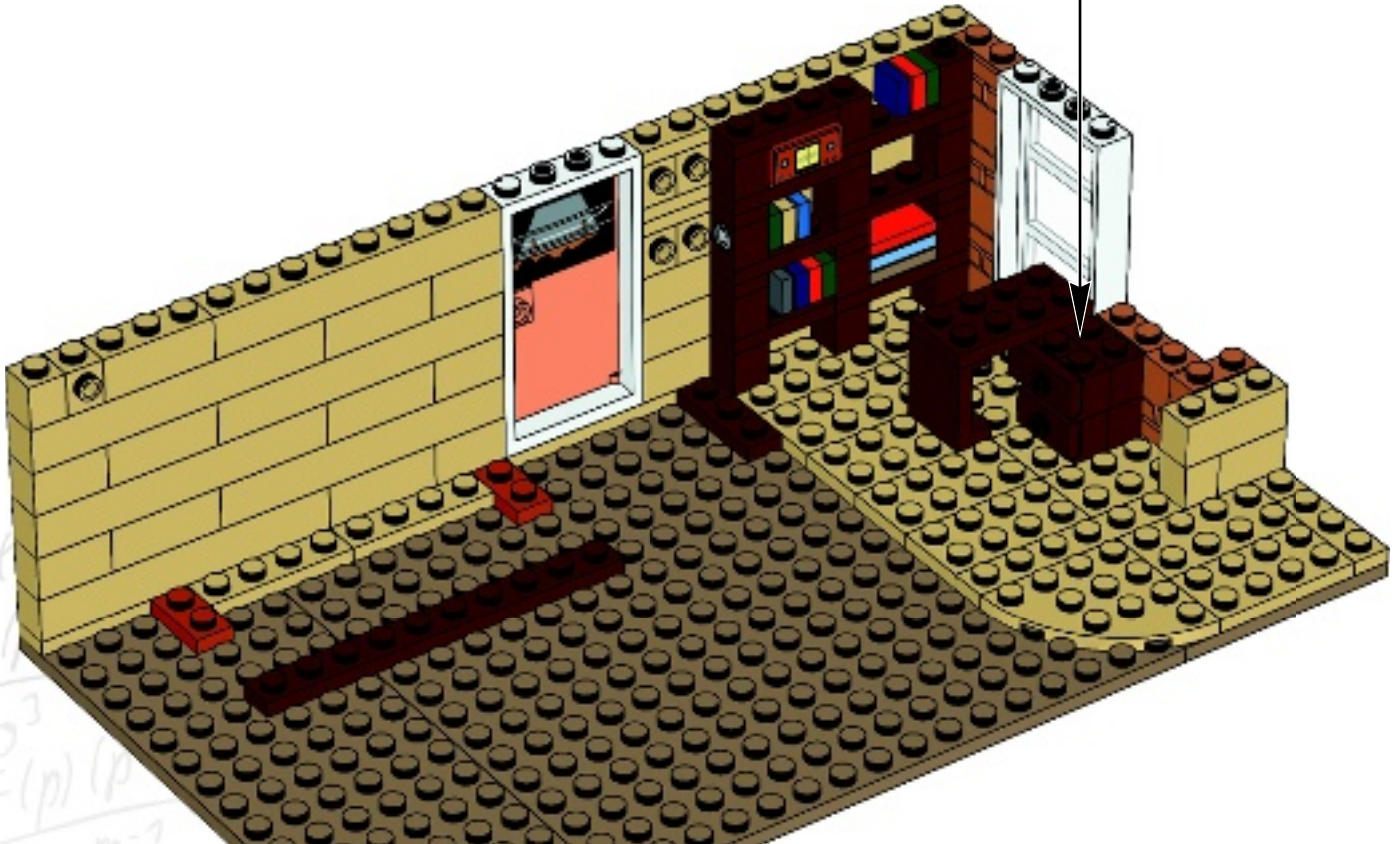
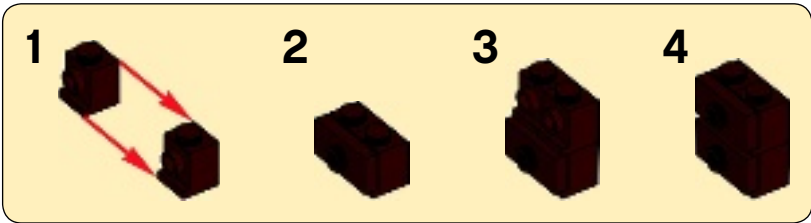

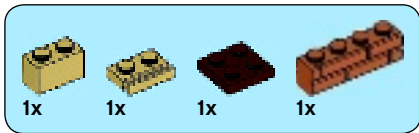

34

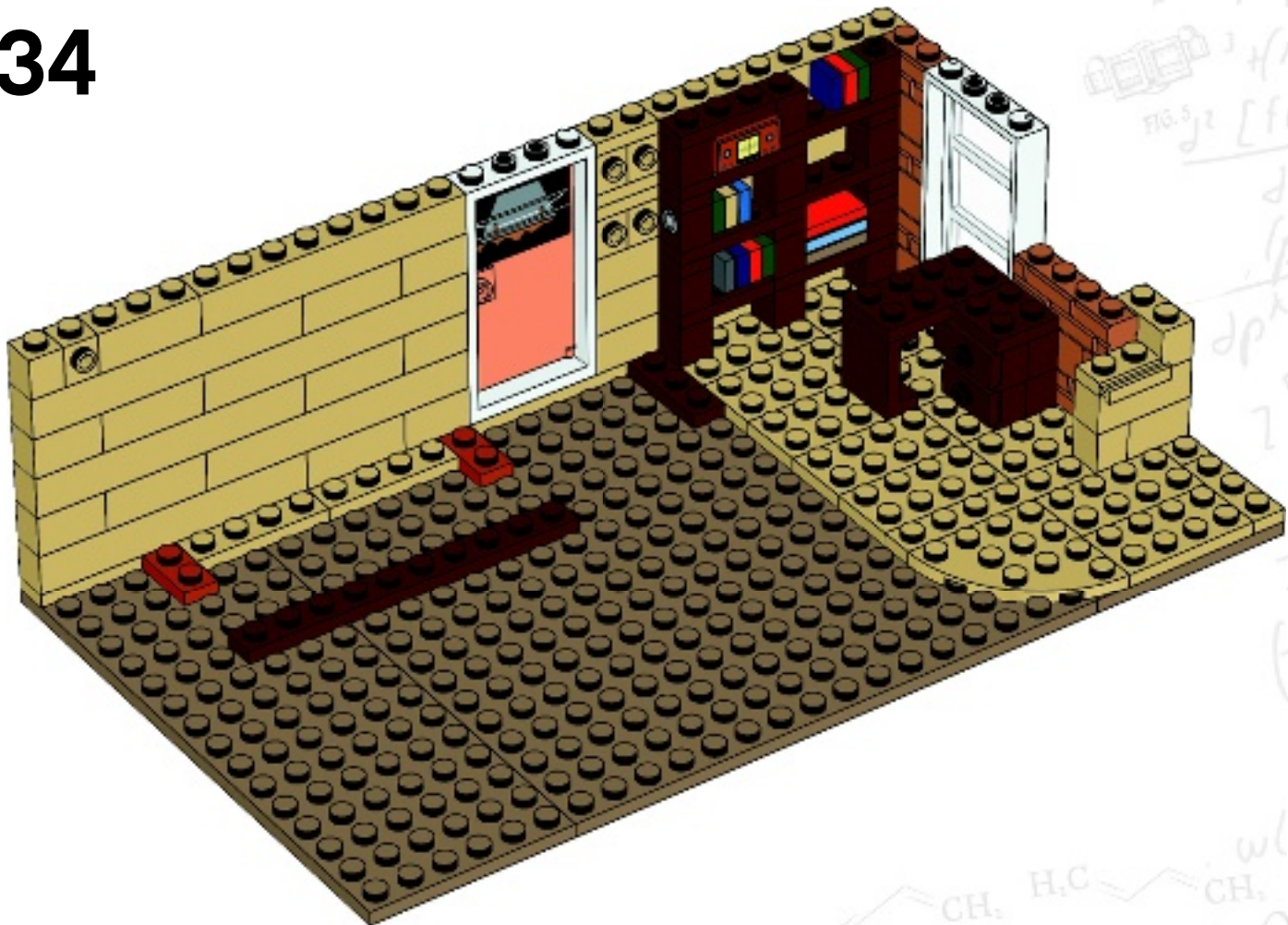

1x	2x	1x	2x

35

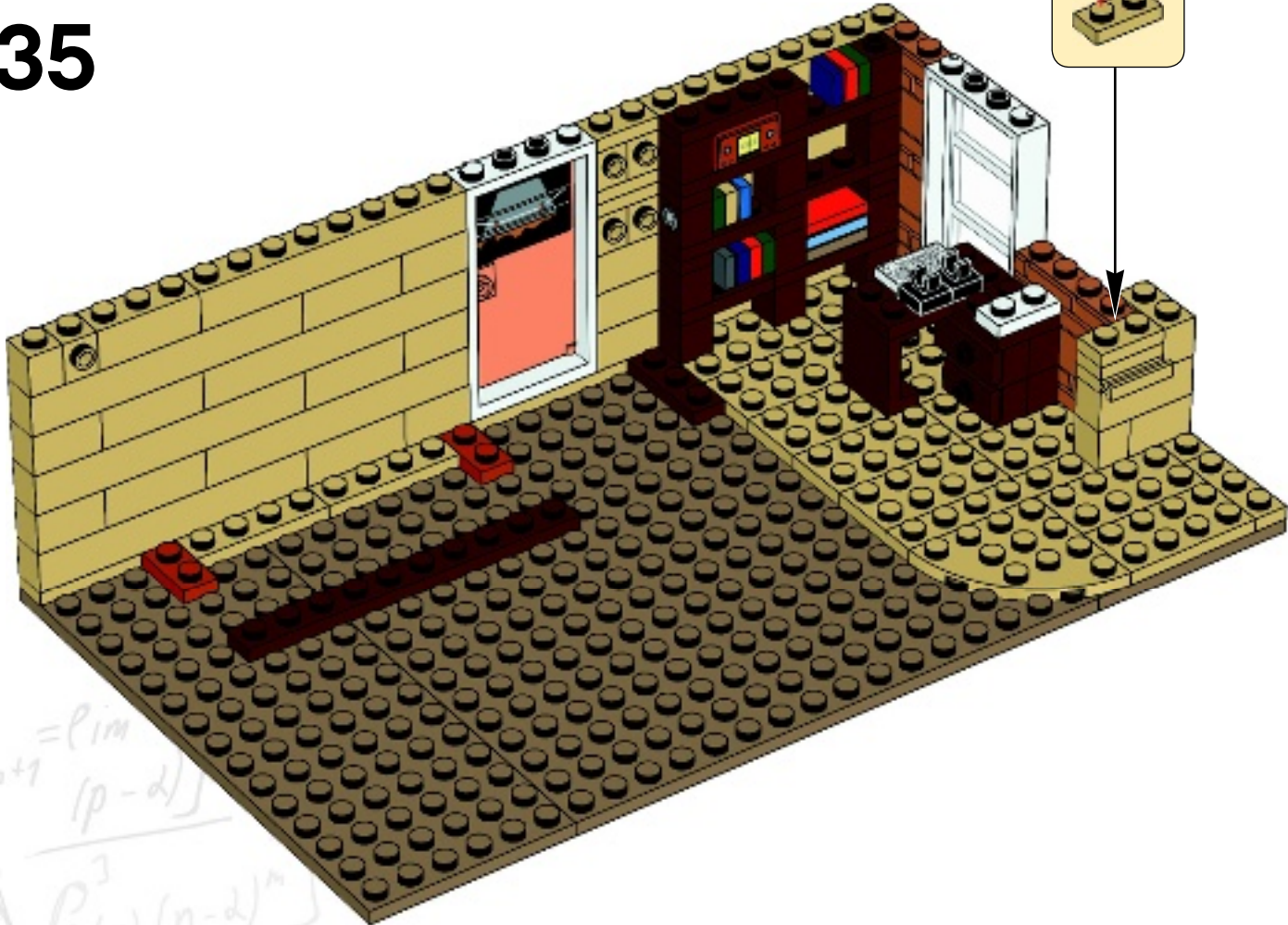
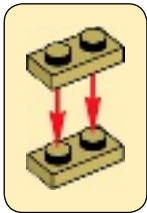

2

$= p \cdot m$

$-m+1$

$(p-d)$

p^3

$F(p)(p-d)^m$

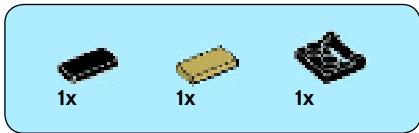

36

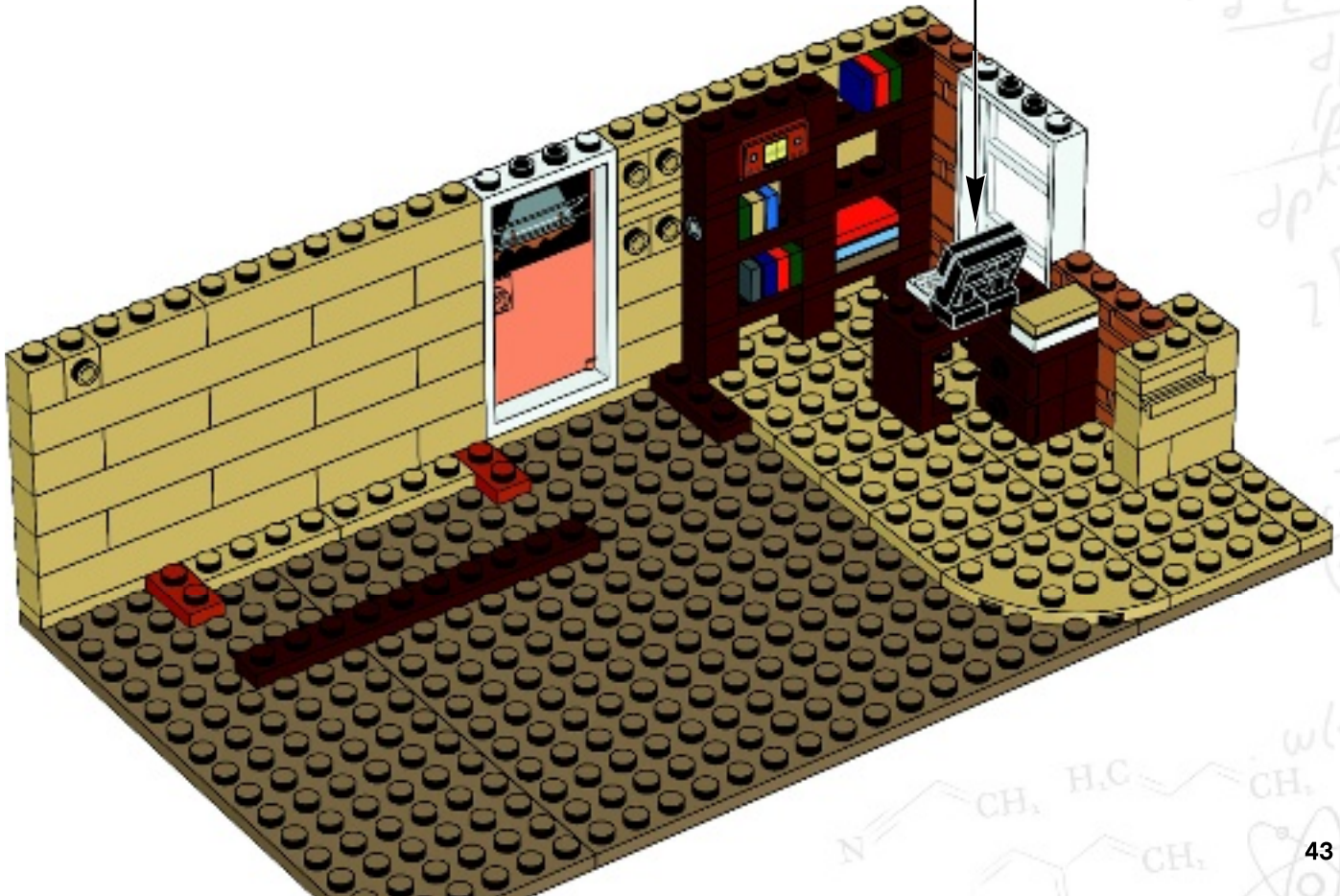
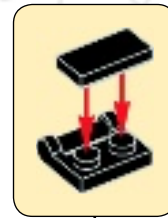

1x

1x

1x

1x

37

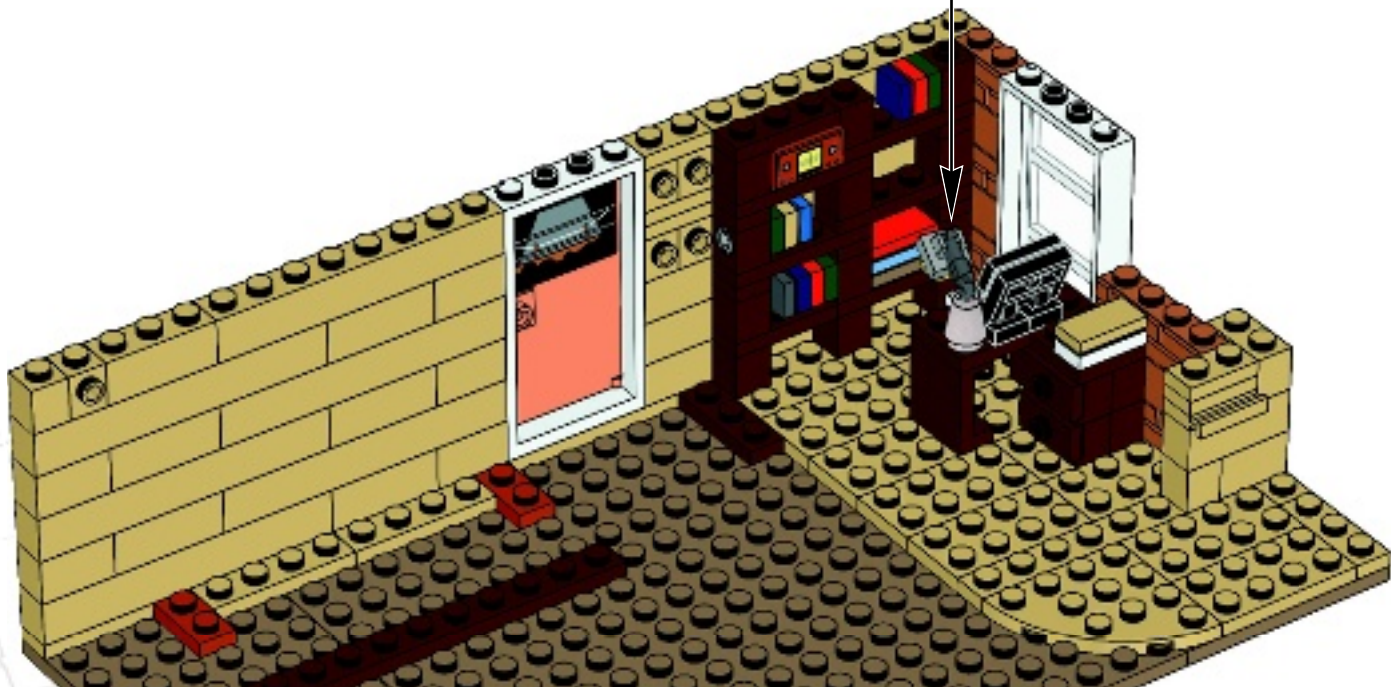
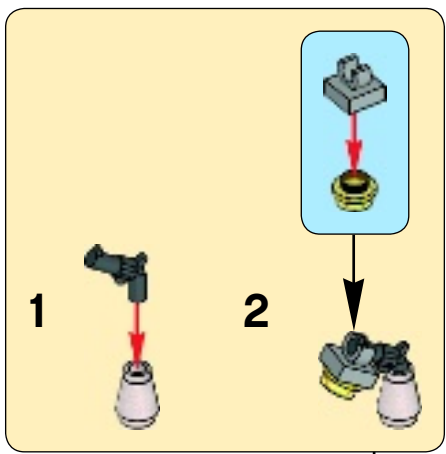



2x



1x



2x



1x

38

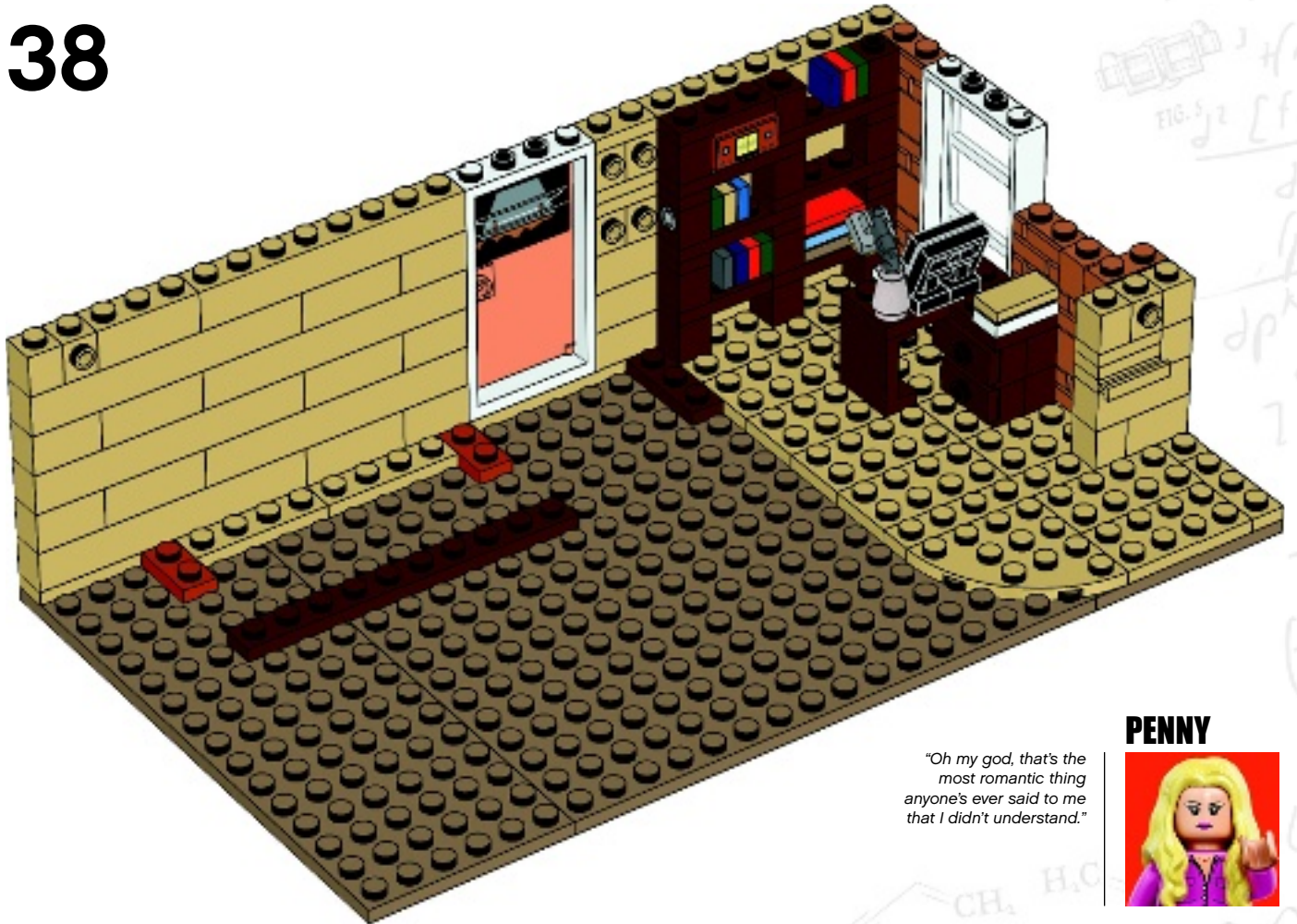

PENNY

"Oh my god, that's the most romantic thing anyone's ever said to me that I didn't understand."





2x



1x

39

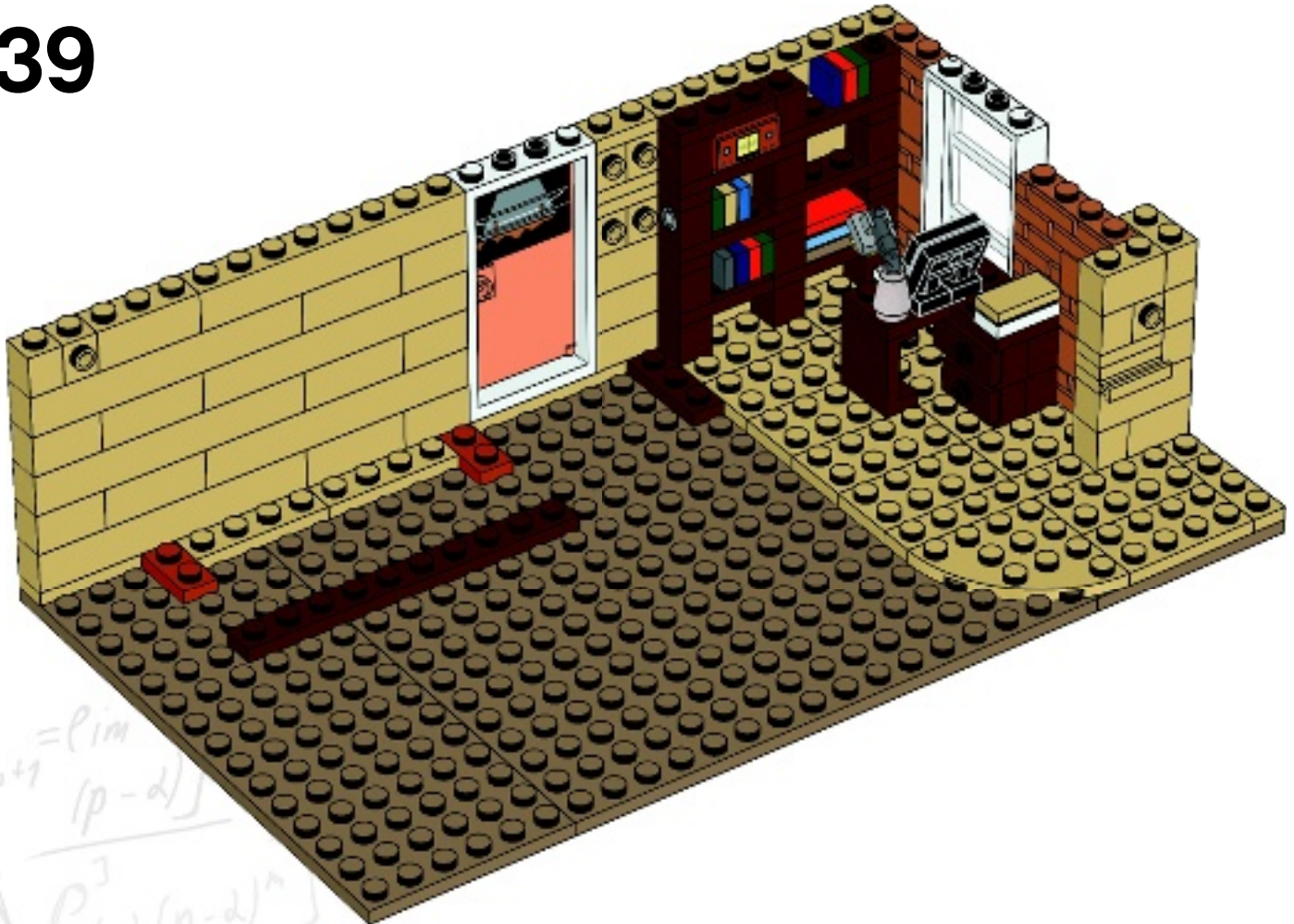



40

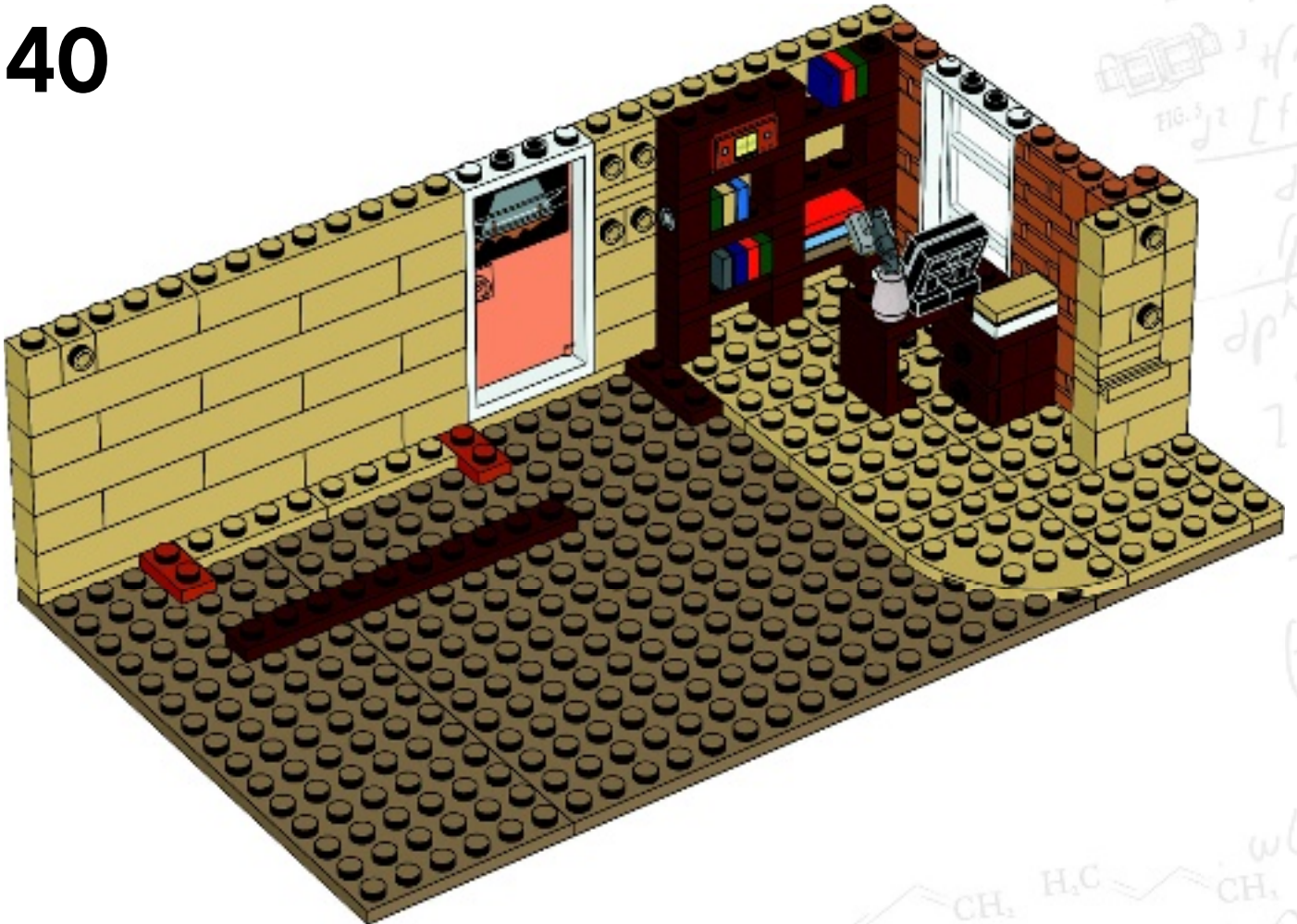

$(n-2)!$

$(-m + (-m+1)(p-q))$

$L = m p^2$

FIG. 3/2 [f/p]

$\frac{dp}{dx}$

$\frac{1}{4}$

$w(d)$

$N = \text{CH}_2 = \text{CH}_2$, $\text{H}_2\text{C} = \text{CH}_2$, $\text{CH}_2 = \text{CH}_2$

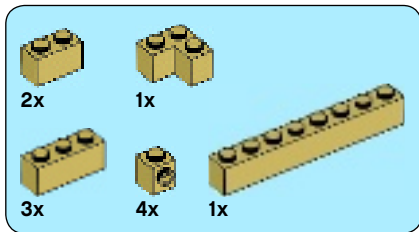

41

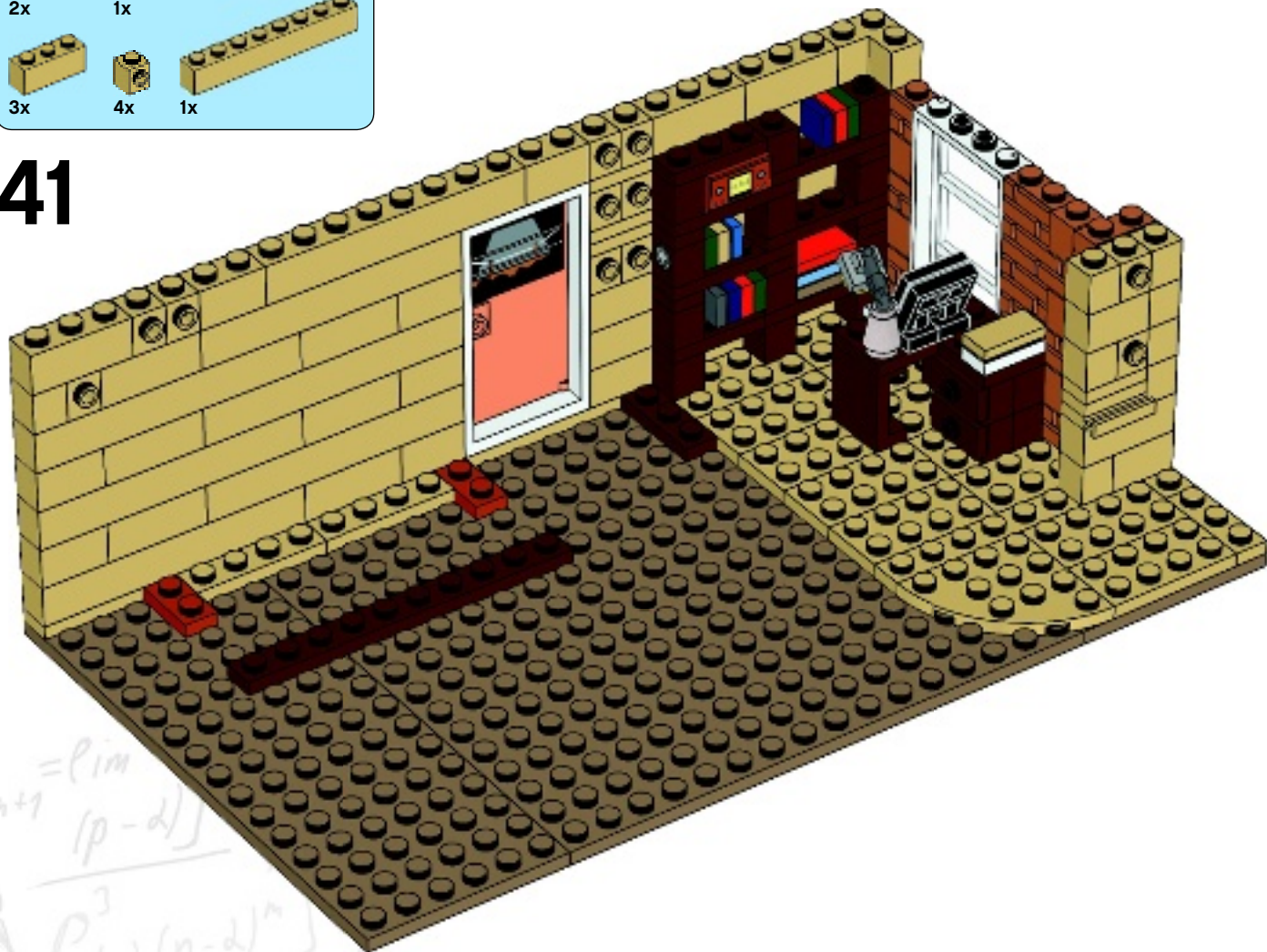

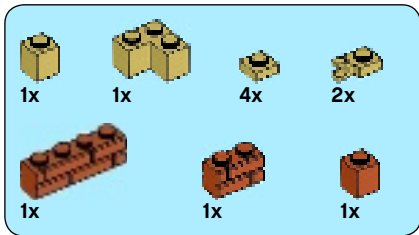

42

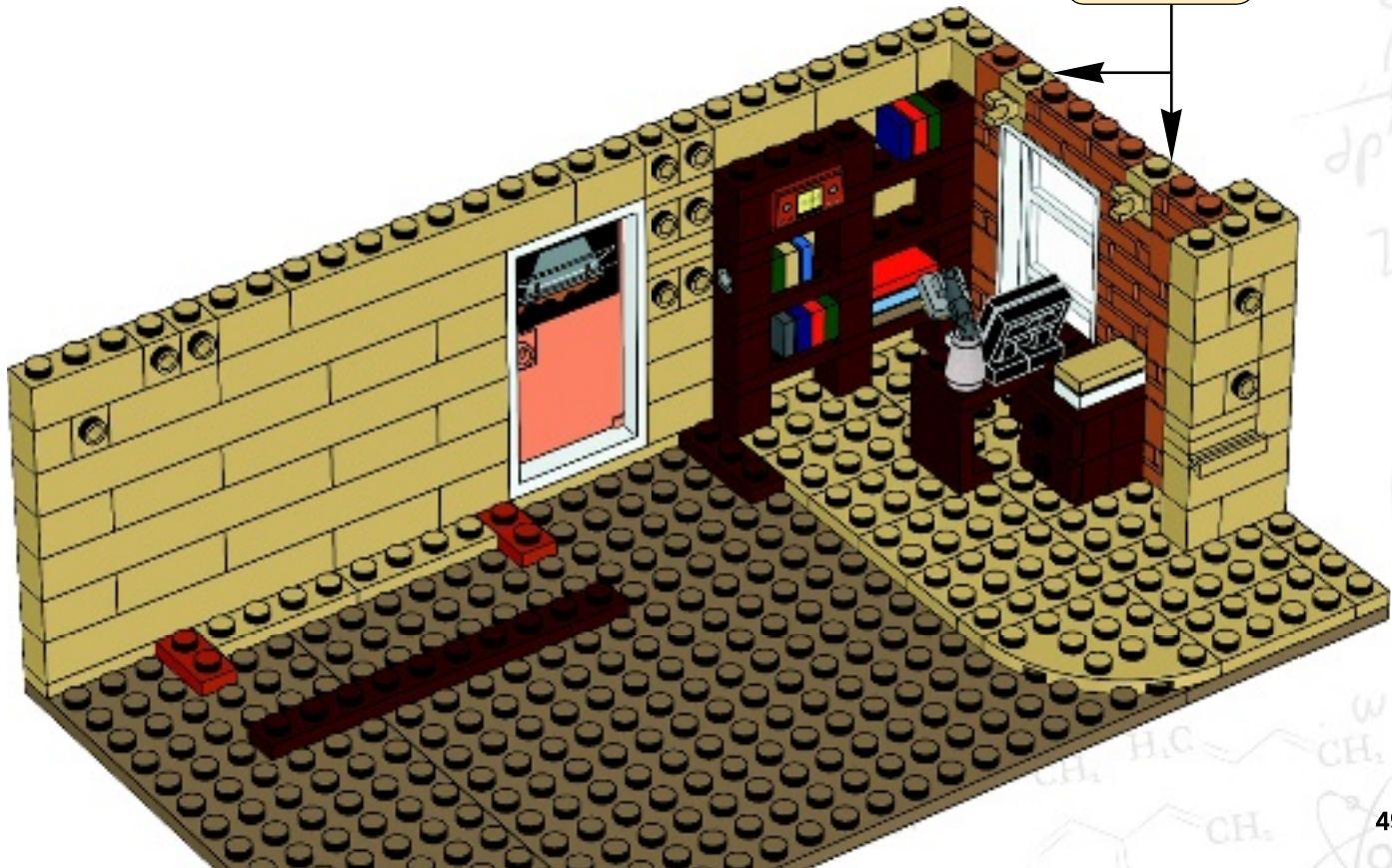
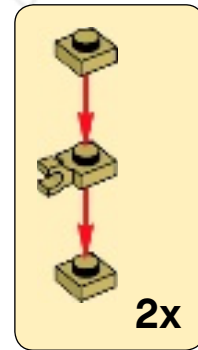



43

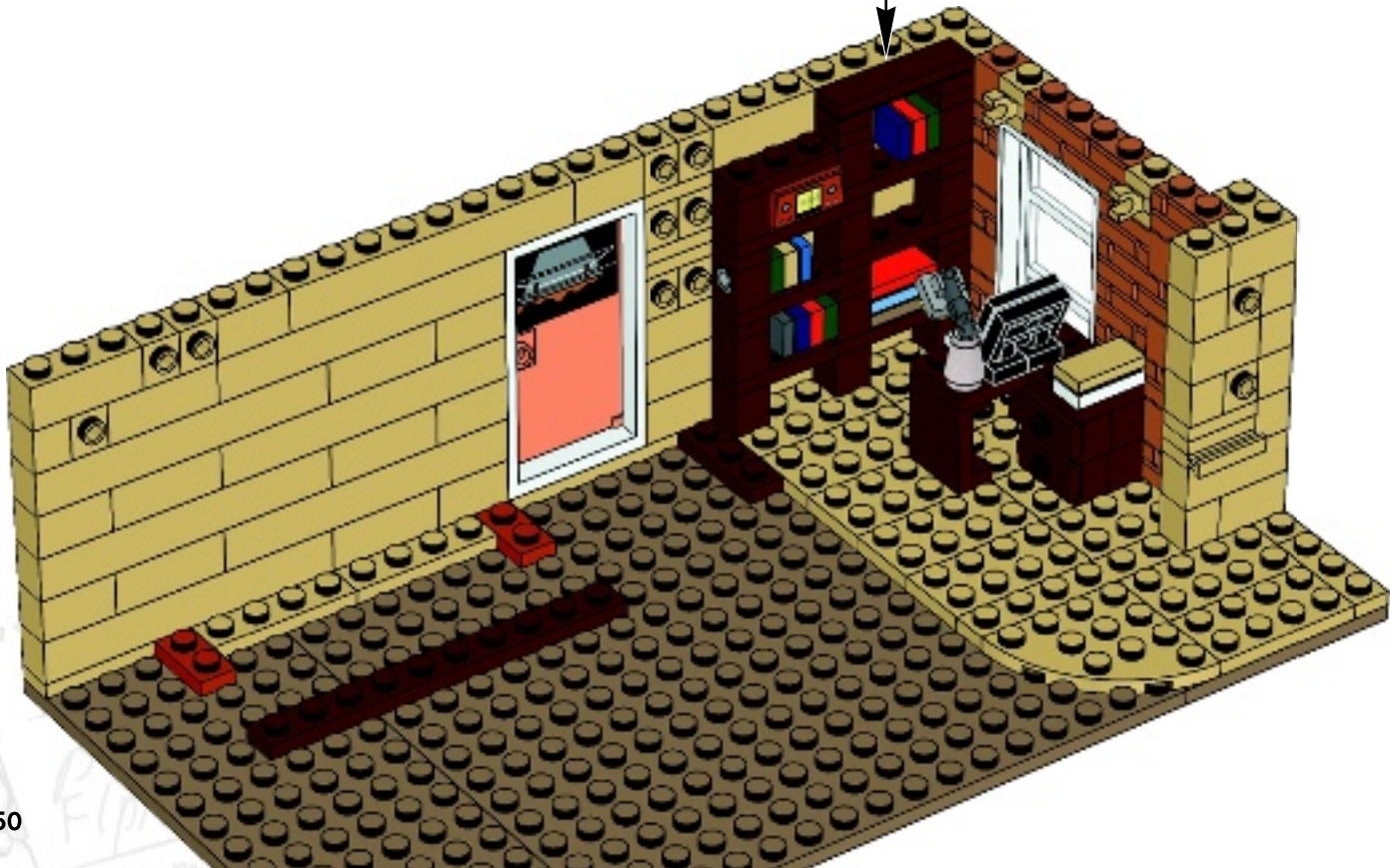
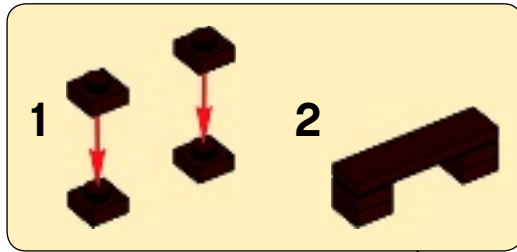

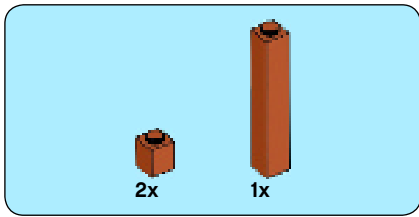

44

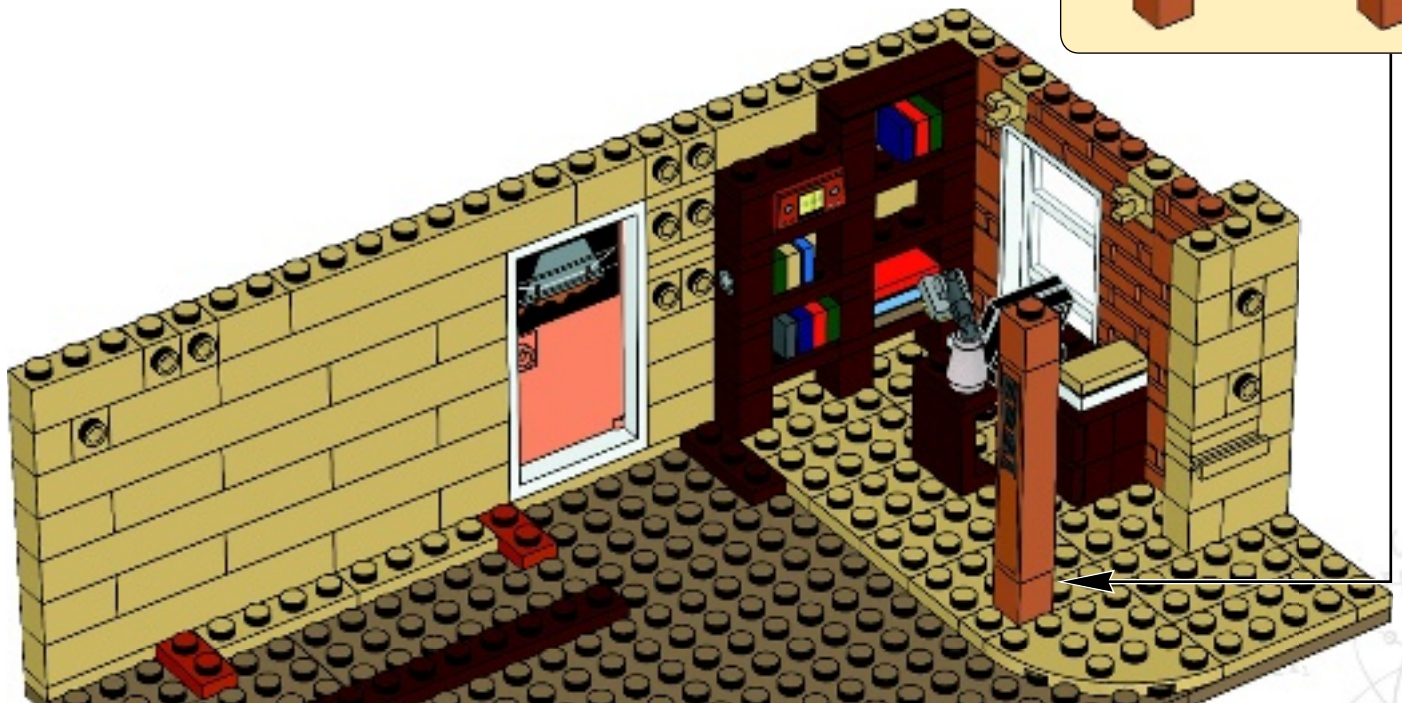
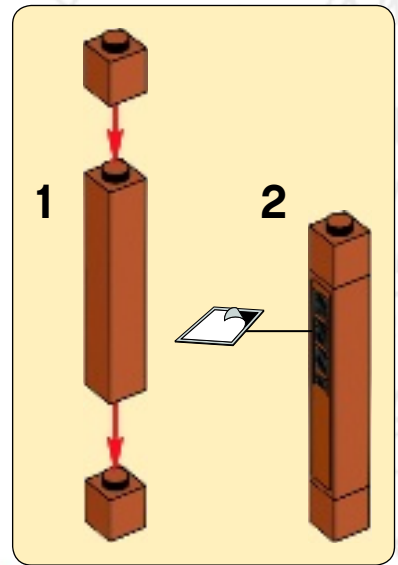

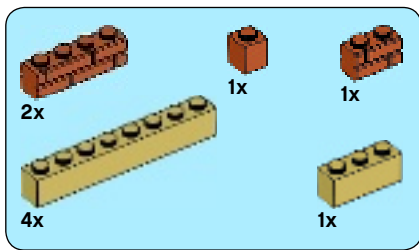

45

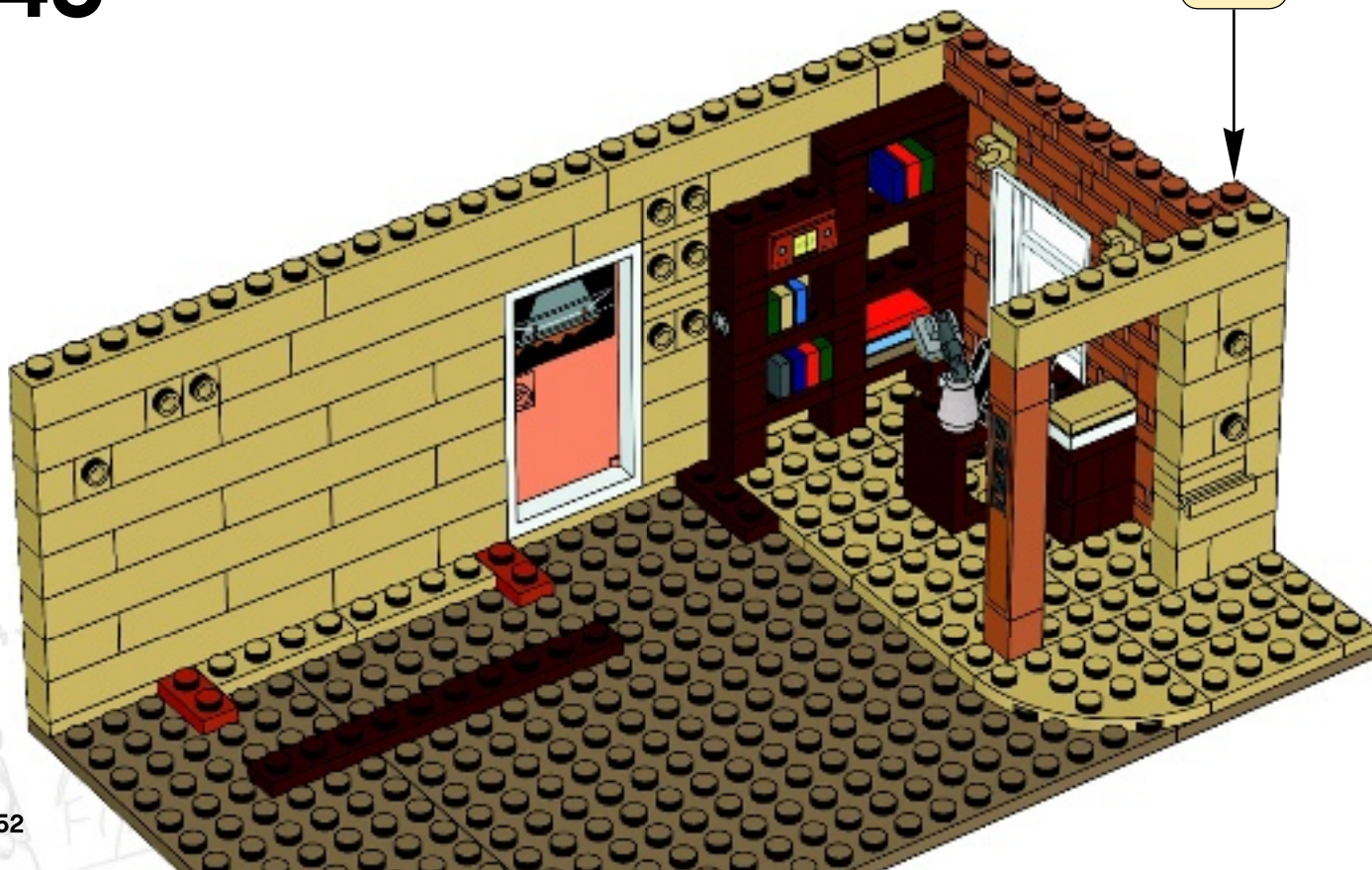

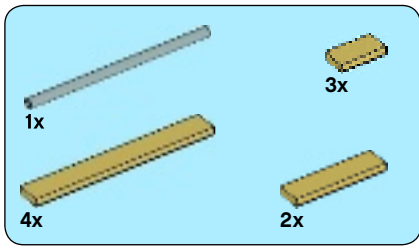

46

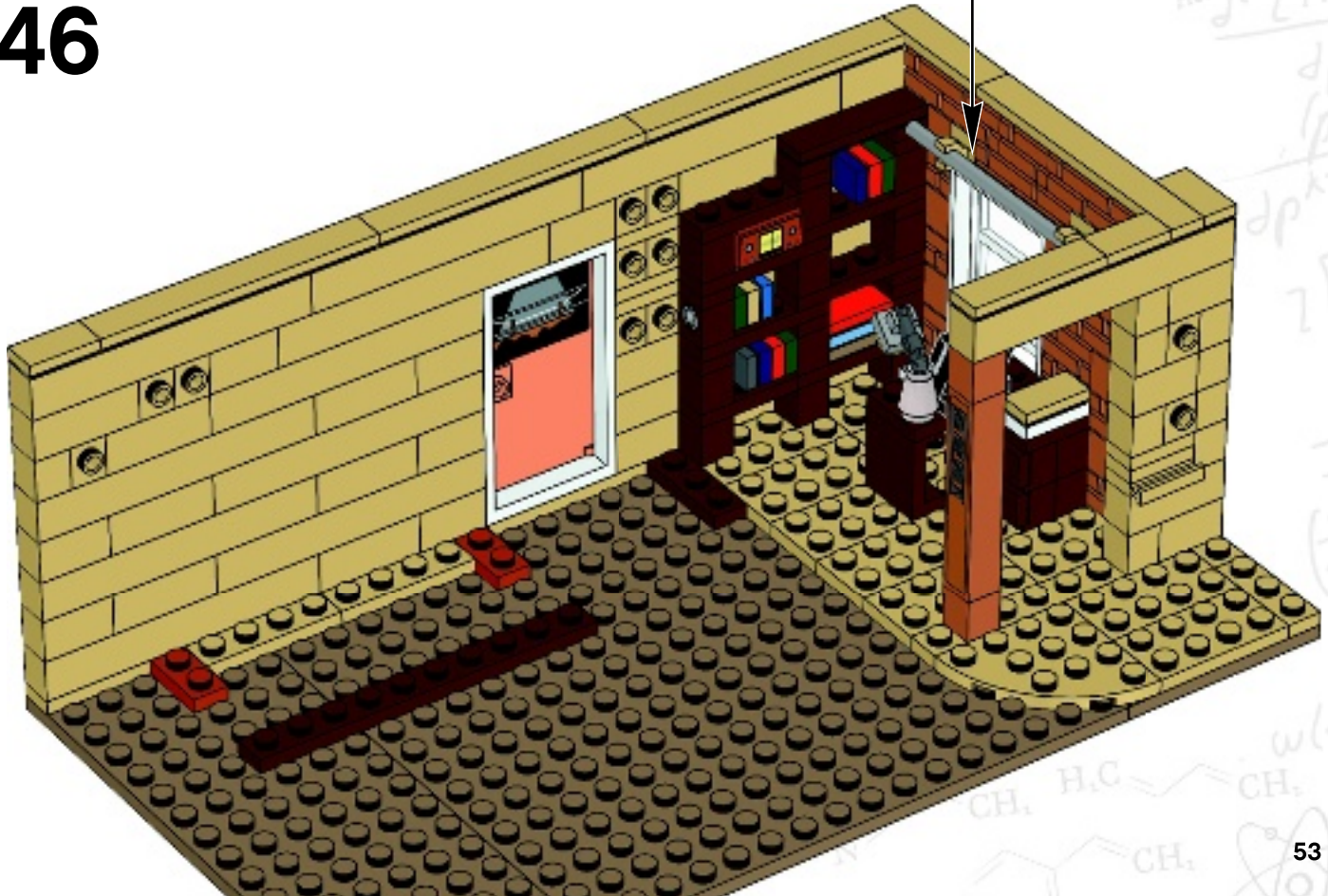
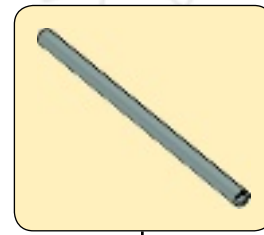

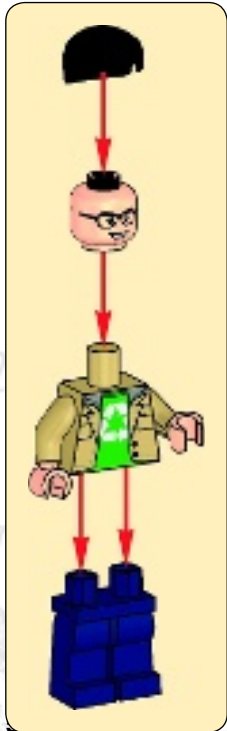

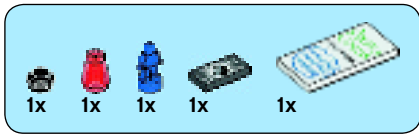

47

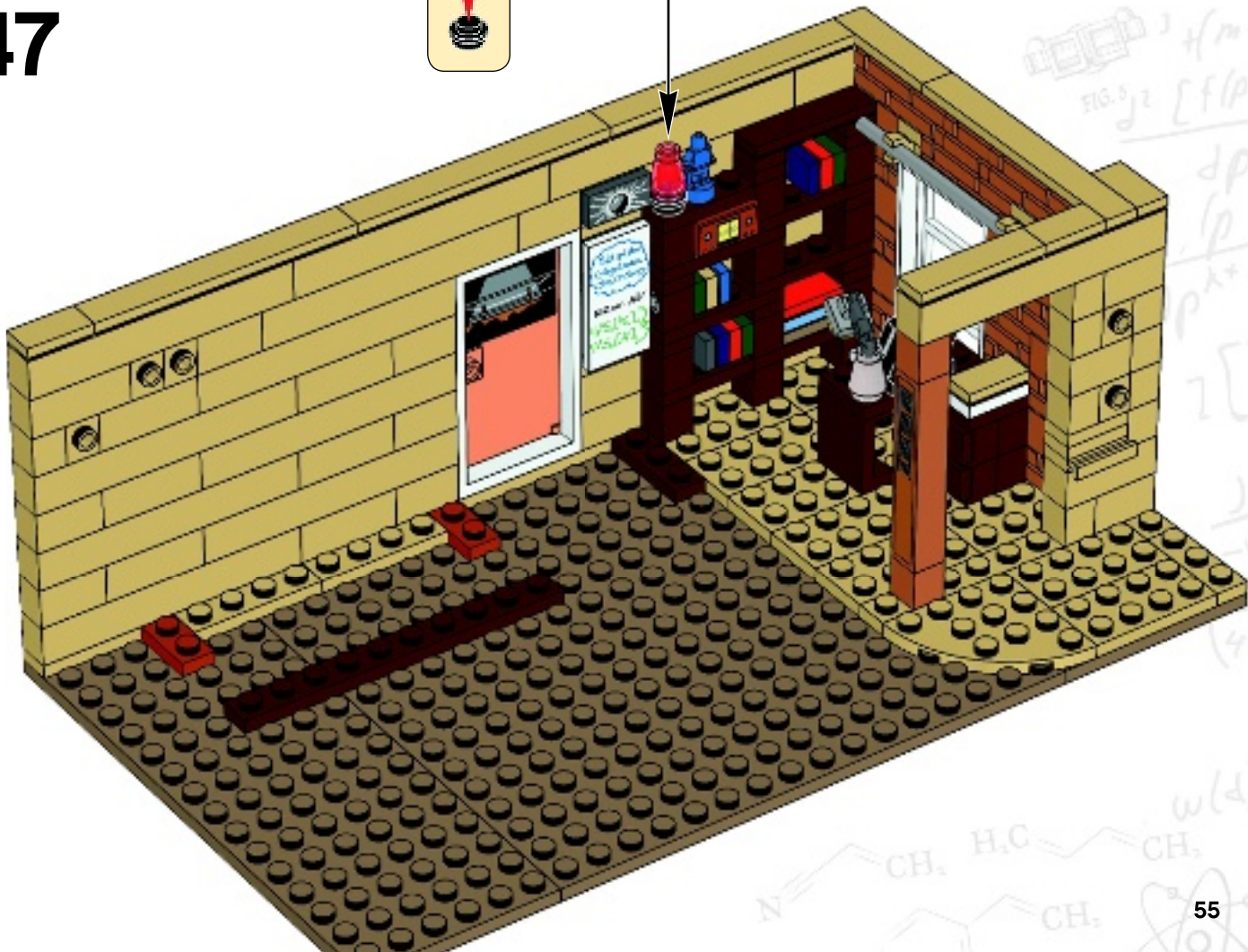

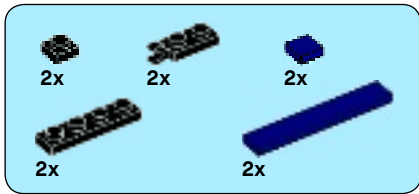

48

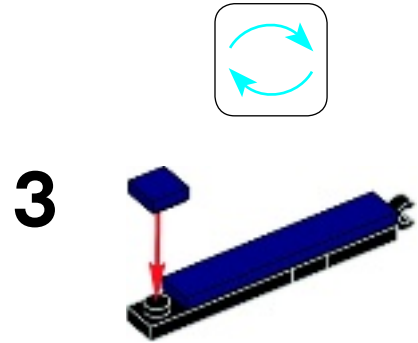
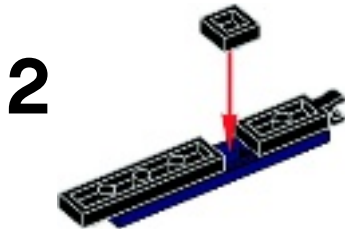
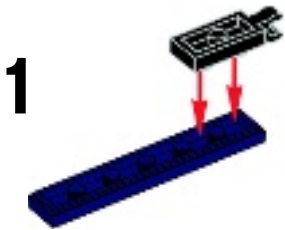

2

$-m+1 = p \cdot m$
 $(p-d)^m$
 $F(p) (p-d)^m$

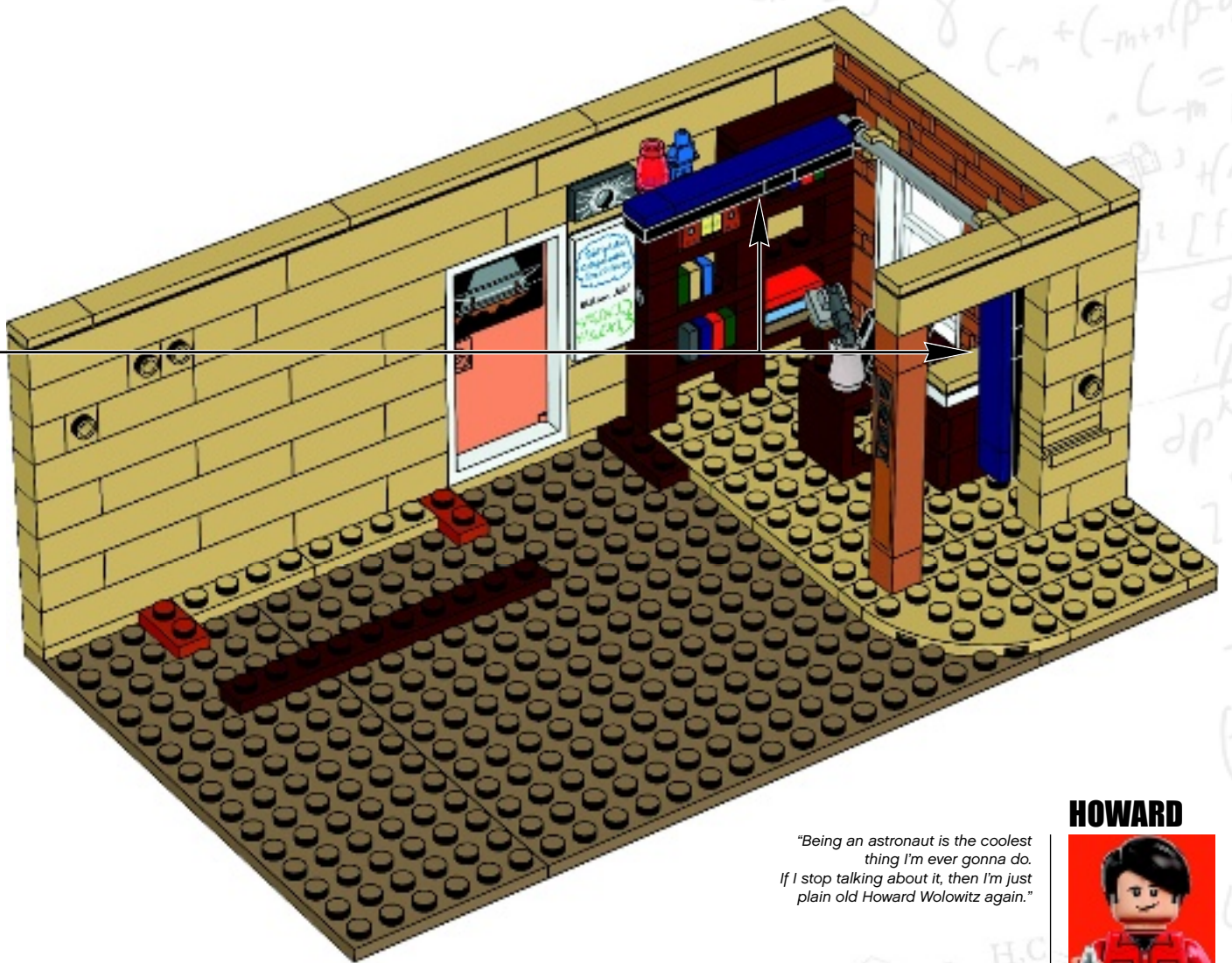

HOWARD

"Being an astronaut is the coolest thing I'm ever gonna do. If I stop talking about it, then I'm just plain old Howard Wolowitz again."



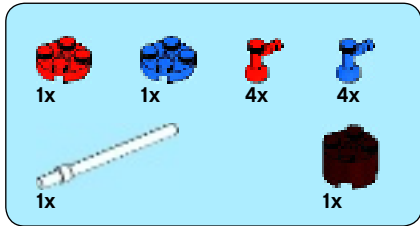
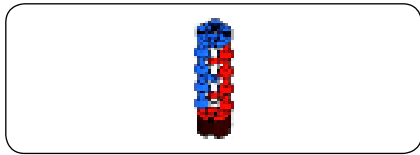

49

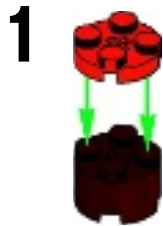

2

$-m+1 = p \cdot m$
 $(p-2)^m$

$F(p)(p-2)^m$

58

4



5



6

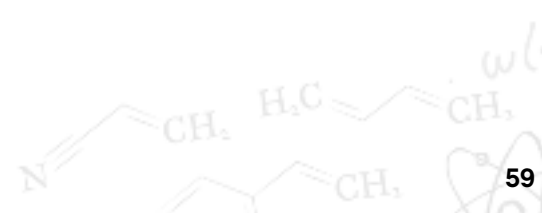

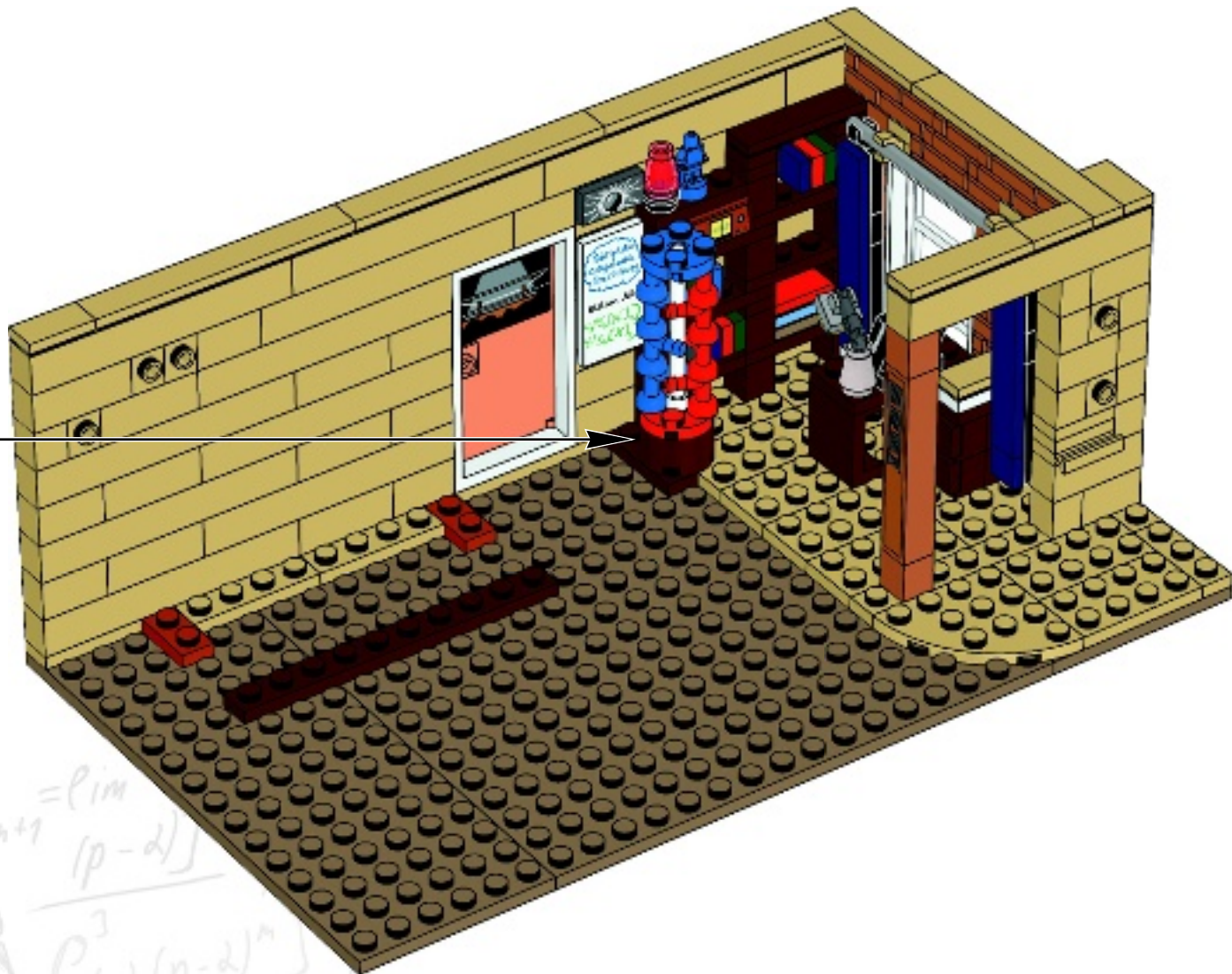

2

$= \frac{p!m}{(p-d)!}$
 $F(p)(p-d)^m$

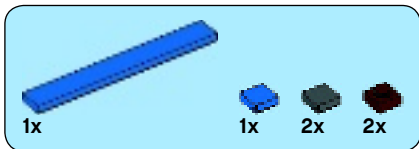

50

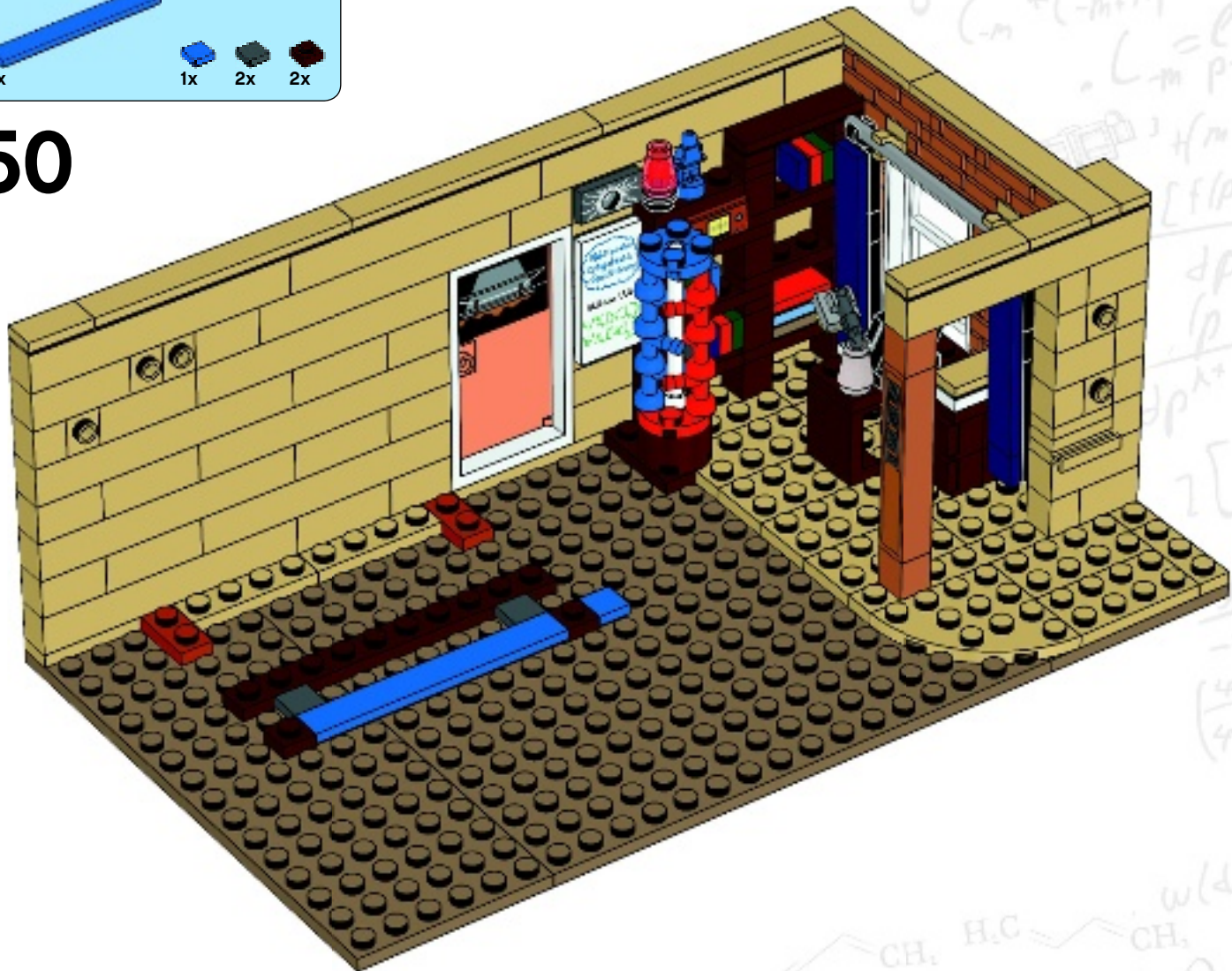

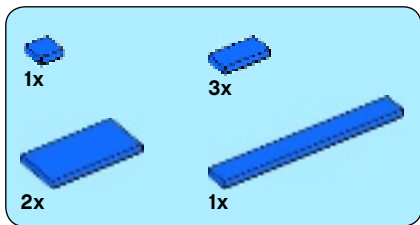

51

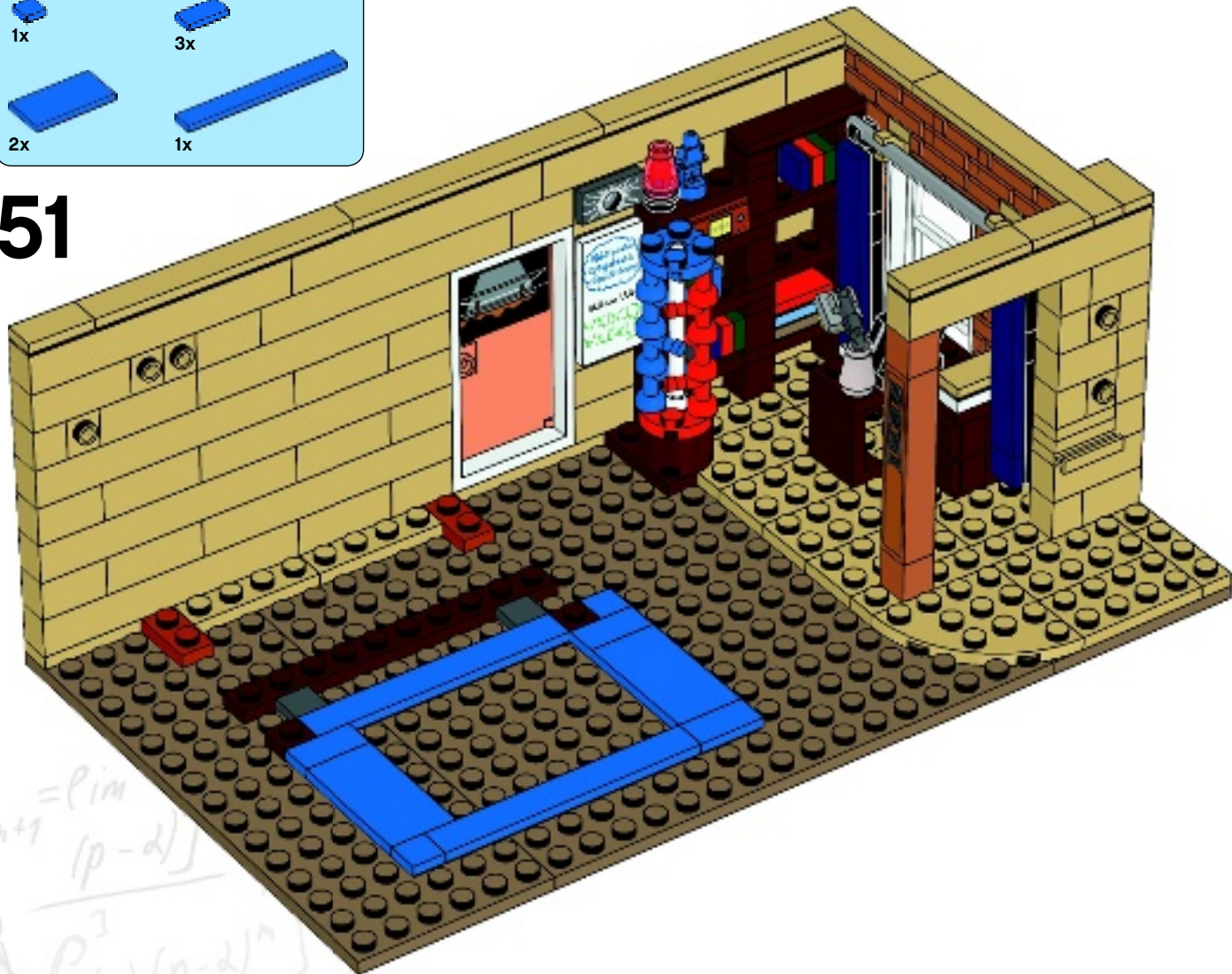

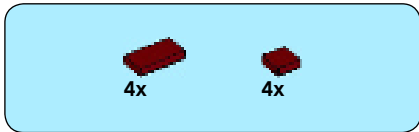

52

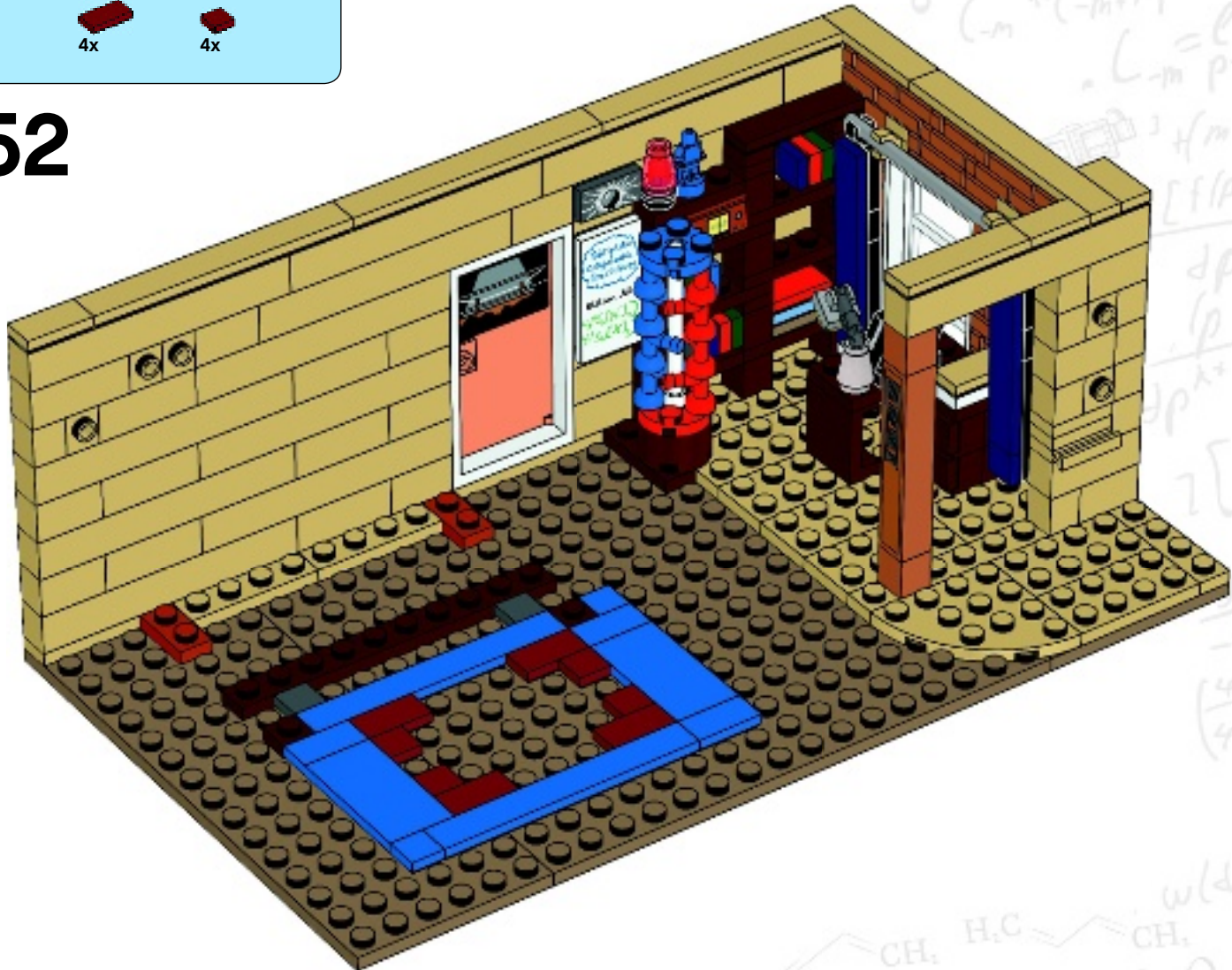

1x 7x 2x

53

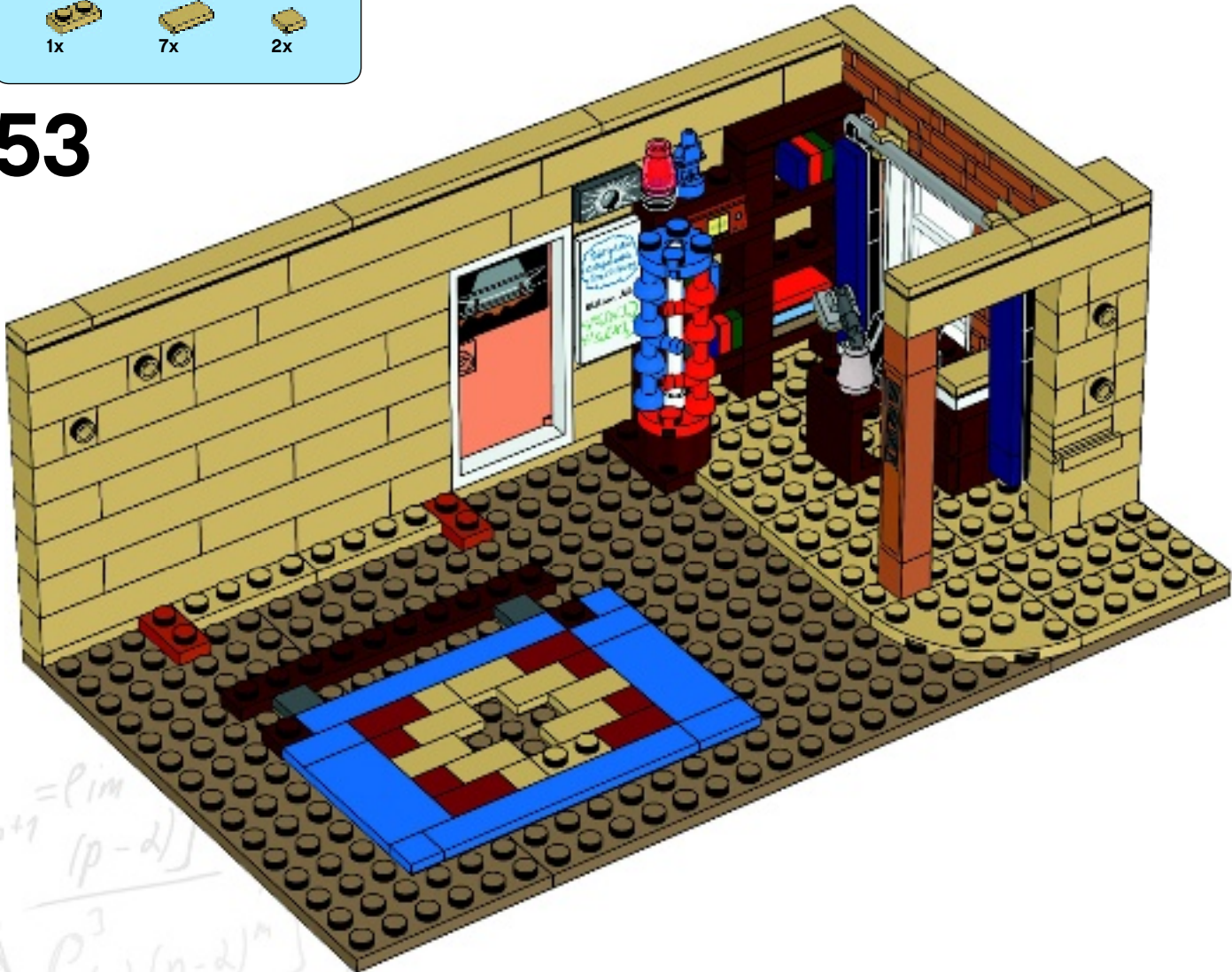

1x

4x



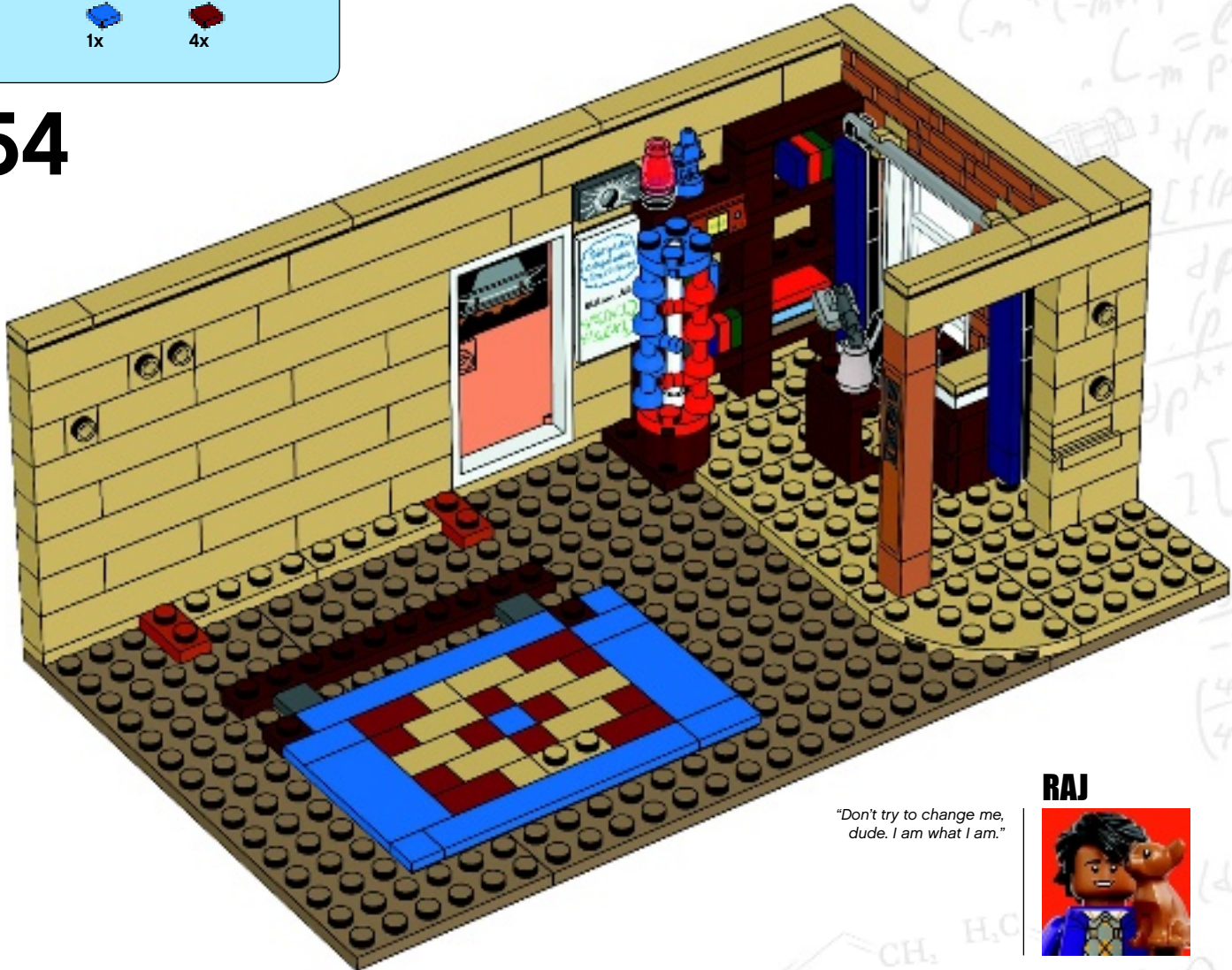

54



RAJ

"Don't try to change me, dude. I am what I am."



			
4x	1x	2x	1x

55



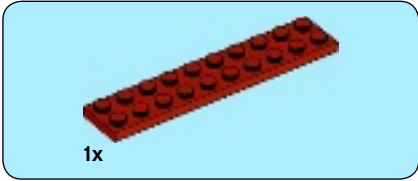
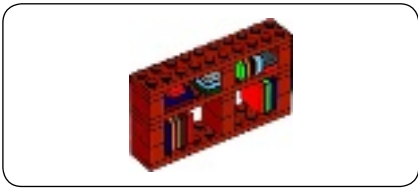

1

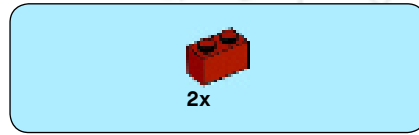
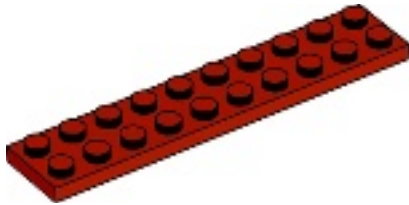

2

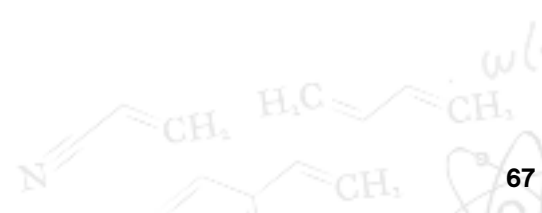
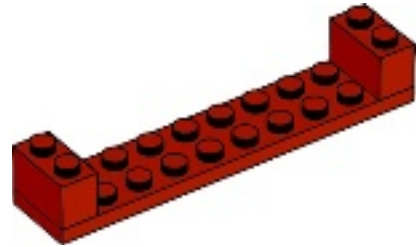



2x



4x

3

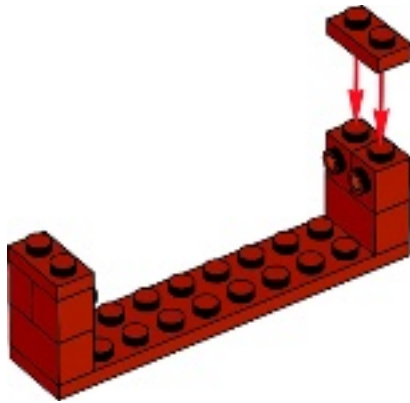

2

$-m+1 = p \cdot i \cdot m$
 $(p-d)^m$
 $F(p) (p-d)^m$
 $m=1$

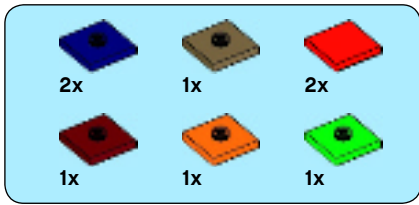

4

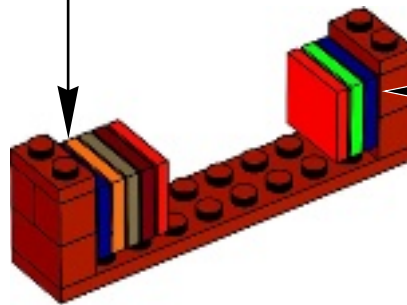
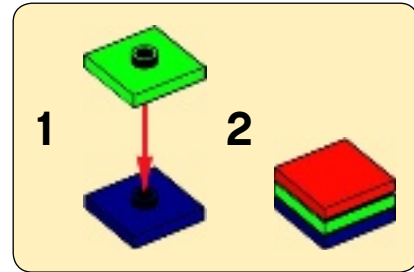
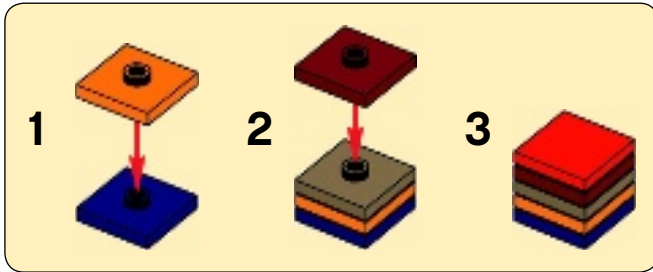

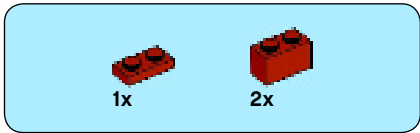

5

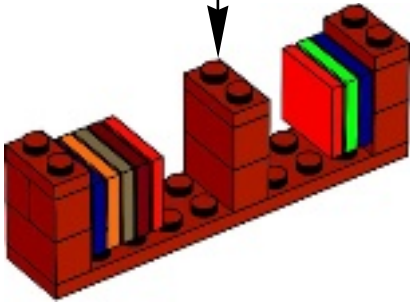
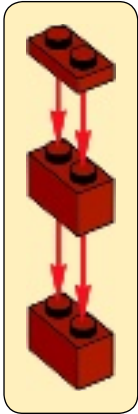

2

$$\frac{p^{m+1} - p^{m+1}}{(p-2)^m}$$

$$\frac{p^3}{F(p)(p-2)^m}$$

$$\frac{p^3}{(p-2)^m}$$

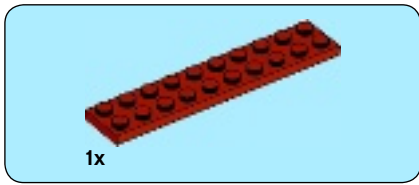

6

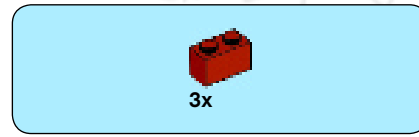
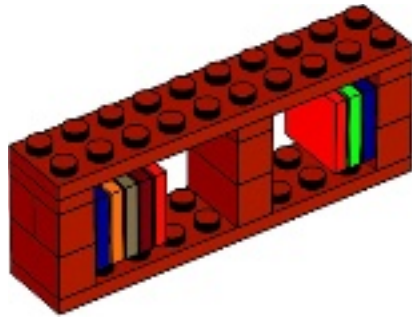

7

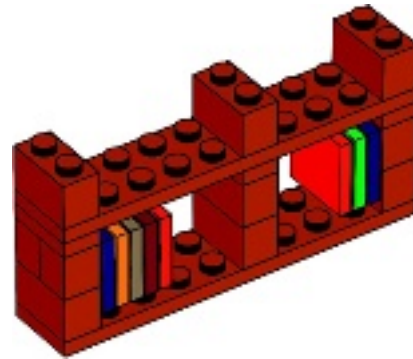

$(n-2)!!$
 $(-m + (-m+2)(p-q) + \dots)$
 $L = l$
 $L = m p =$
FIG. 52 [f/p]
 $\frac{dp}{p}$
 $\frac{dp}{p^{1+}}$
 $z[$
 $\frac{1}{4}$
 $\frac{1}{4}$
 $\omega(d)$
 $N \equiv C = CH_2$
 $H_2C = CH - CH_2$
 CH_2
71

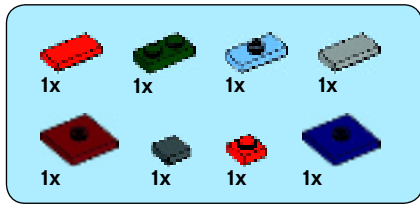

8

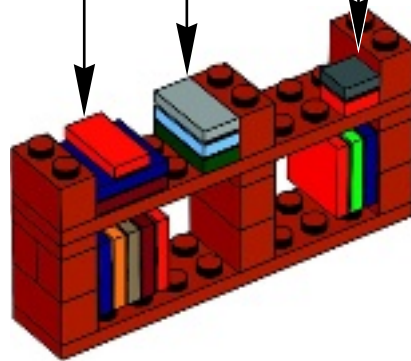
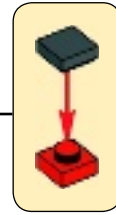
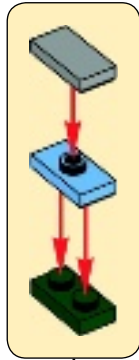
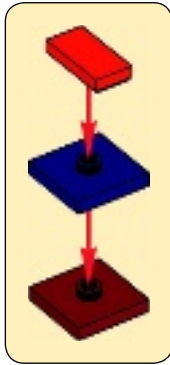

2

$= \rho_{im}$

$[-m+1 \quad (p-d)^m]$

ρ^3

$F(p) (p-d)^m$

72

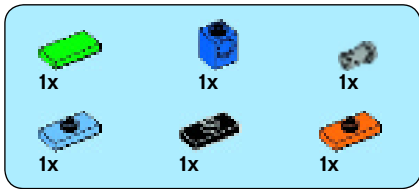

9

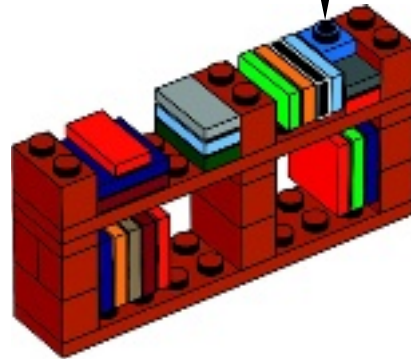
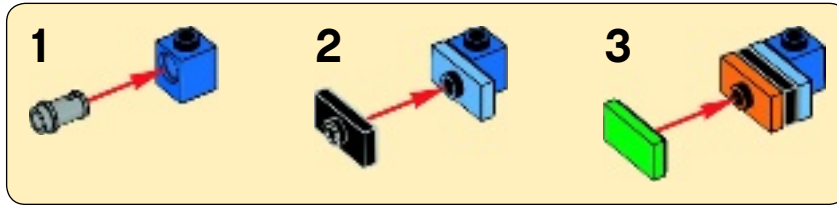



3x

10

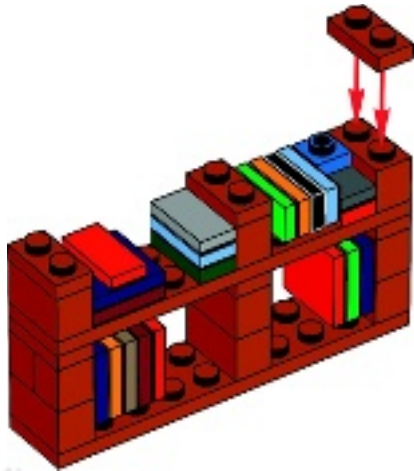

1x

11

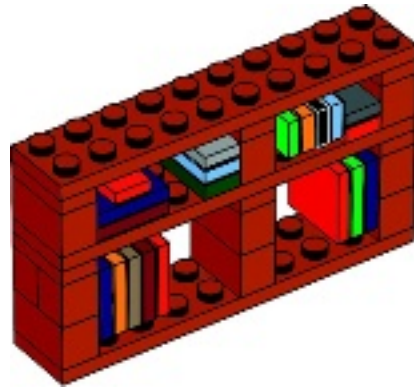

56

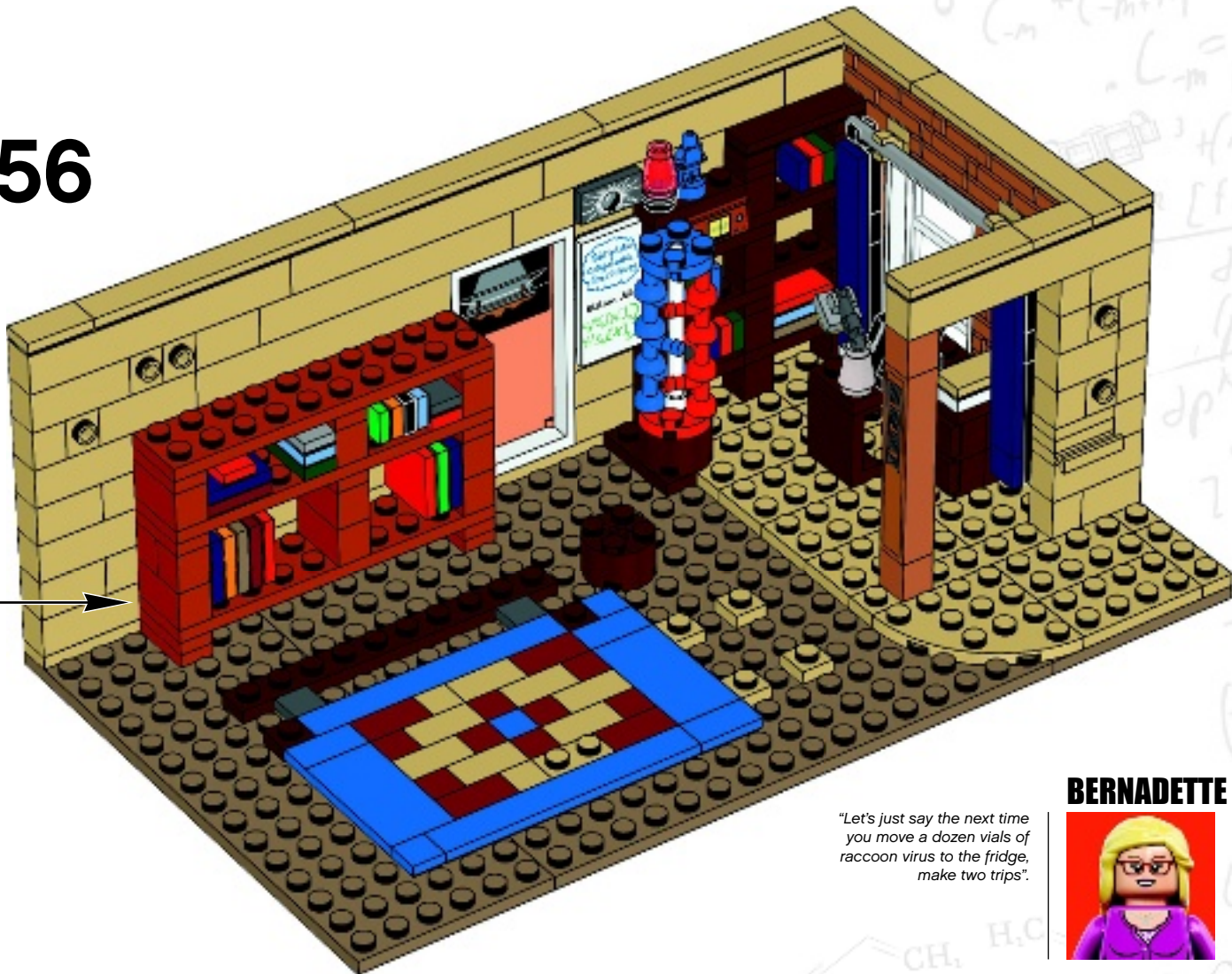

BERNADETTE

"Let's just say the next time you move a dozen vials of raccoon virus to the fridge, make two trips."

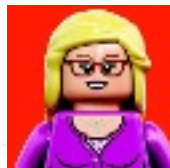



57

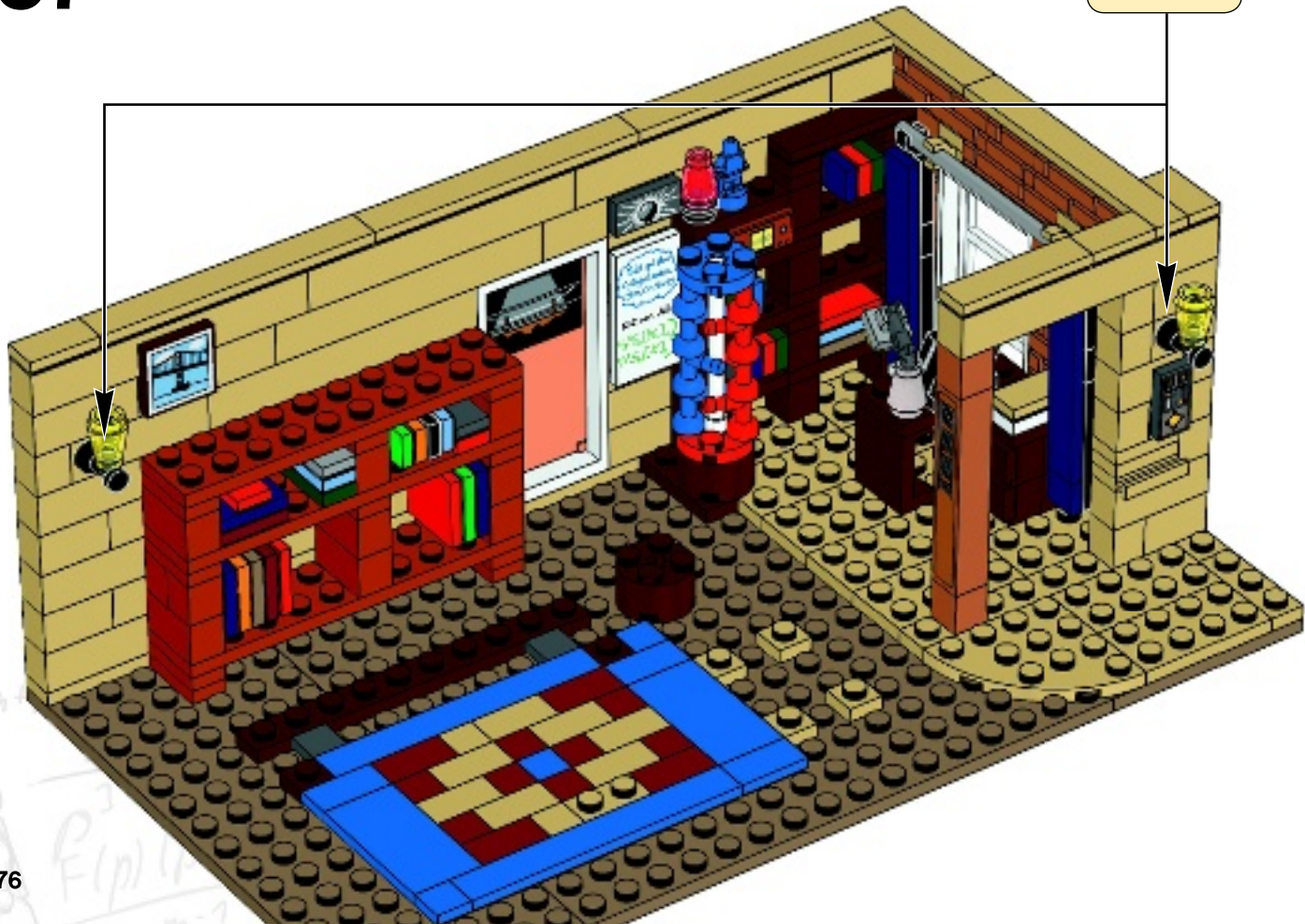



4x



4x

58



4x



4x

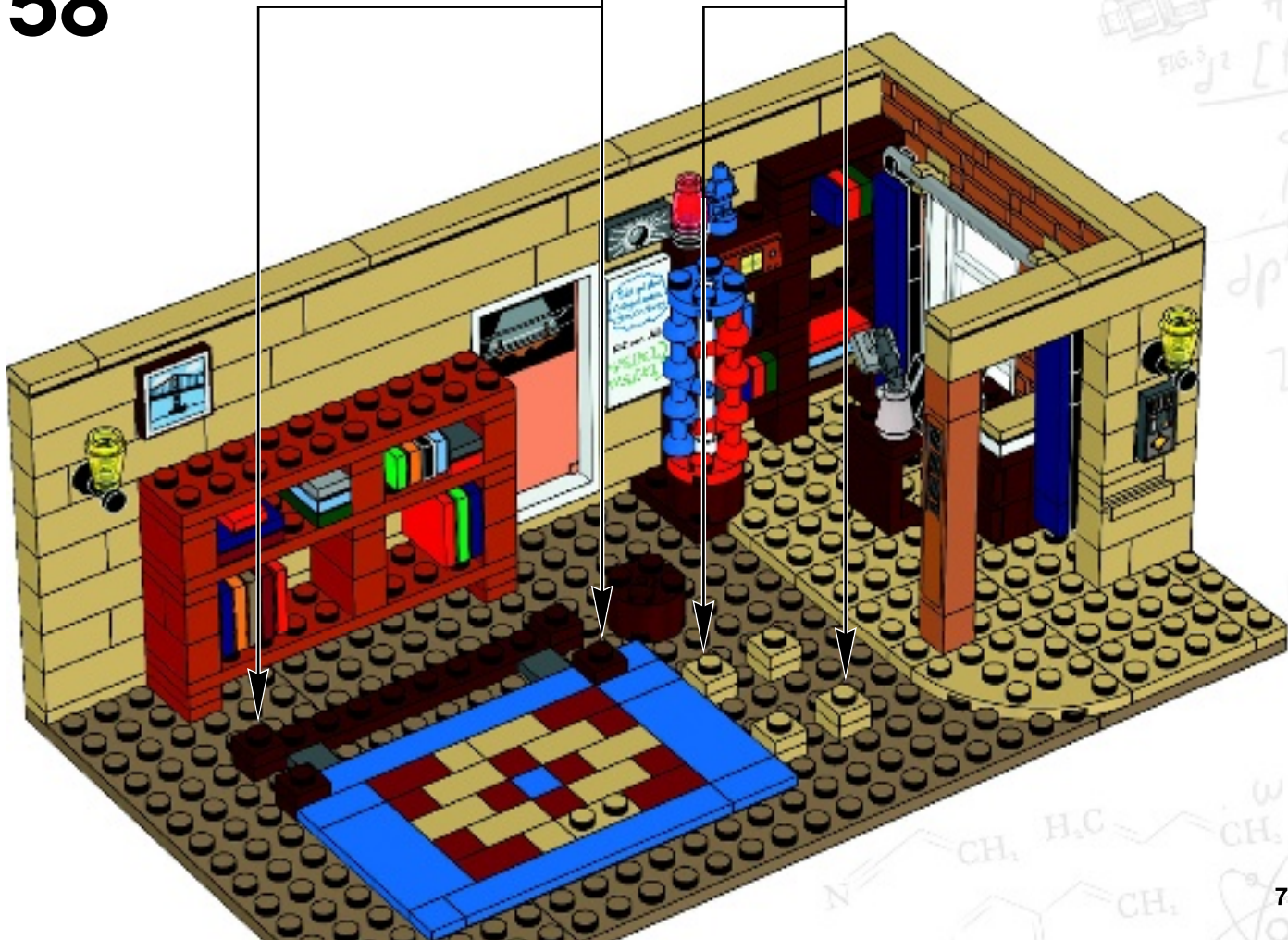

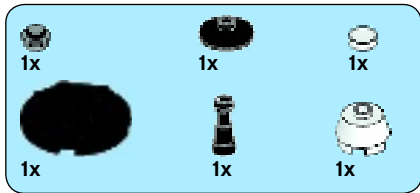

59

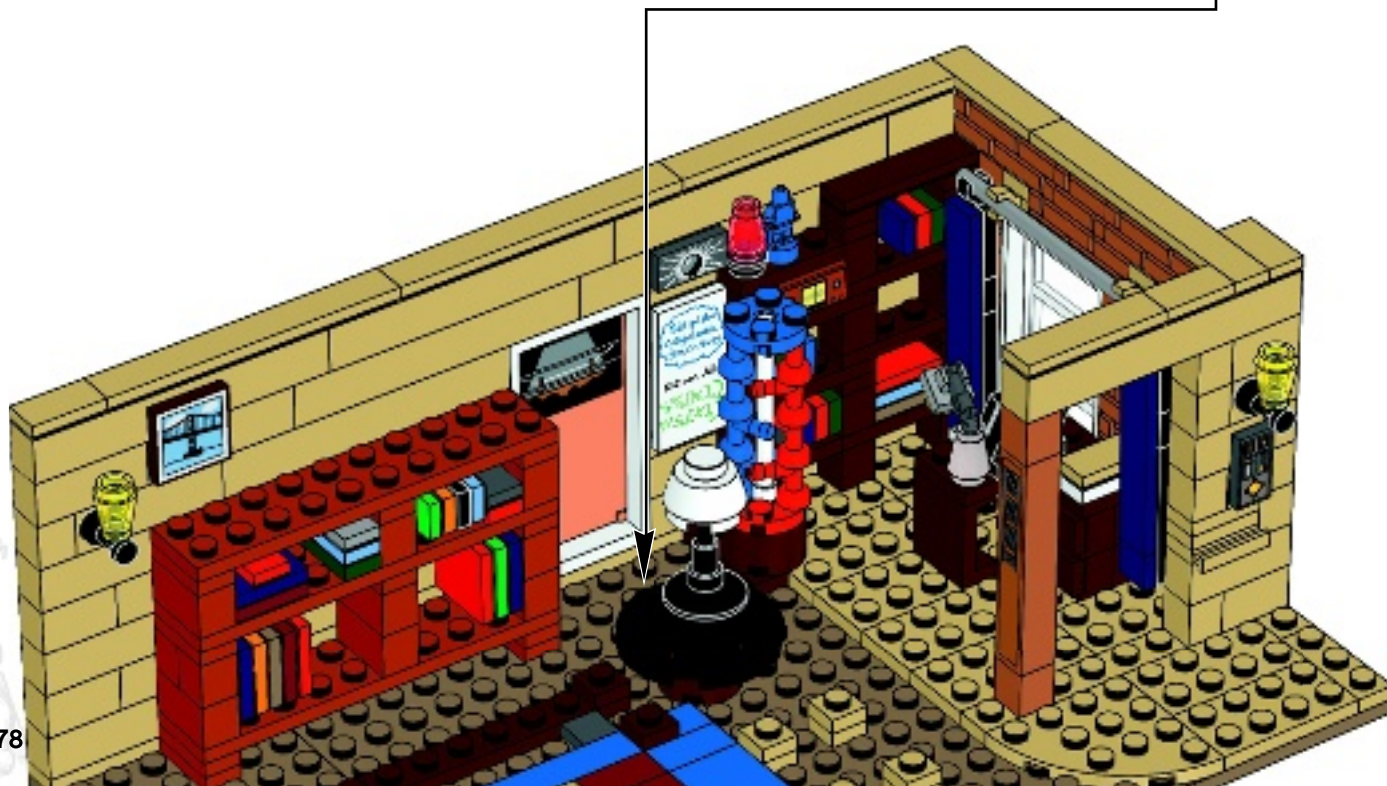
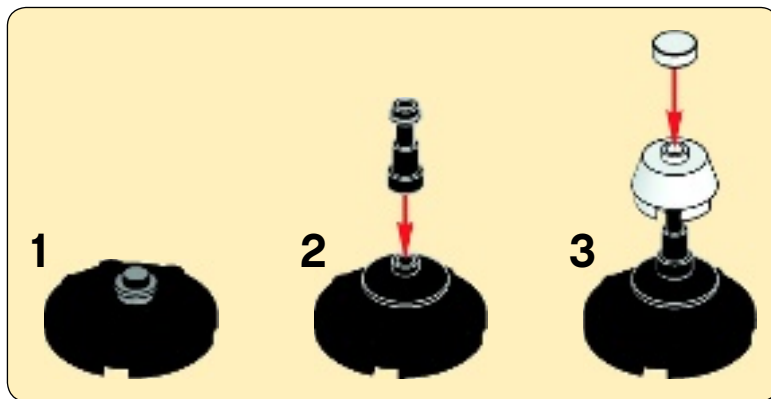

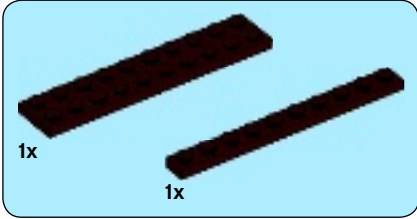
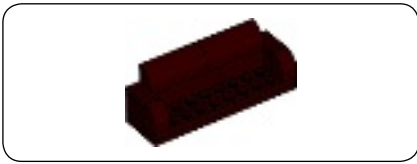

1

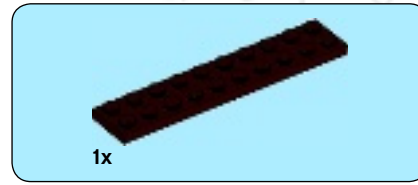
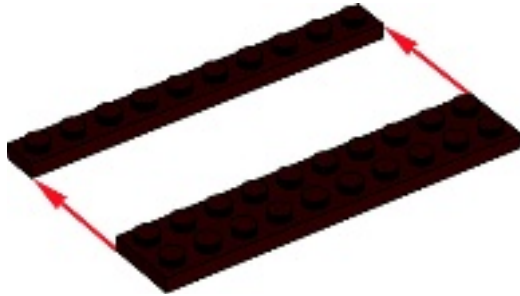

2

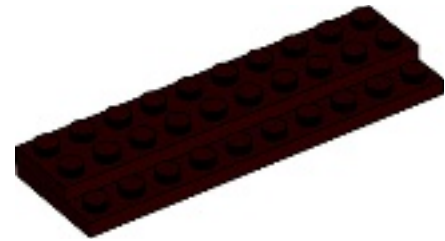

$N \equiv C \equiv C - CH_2 - H_2C = C - CH_2$
 $\omega(d)$
79

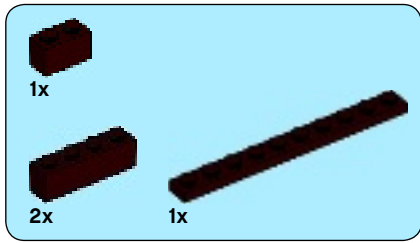

3

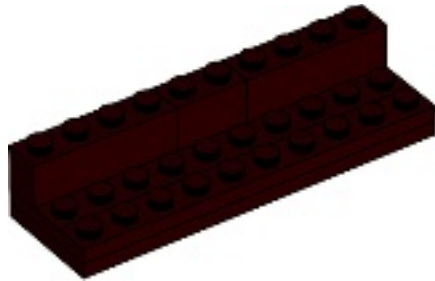

2

$-m+1 = p \cdot m$
 $\frac{1}{(p-d)^m}$
 $\frac{p^3}{F(p)(p-d)^m}$
 $m=1$

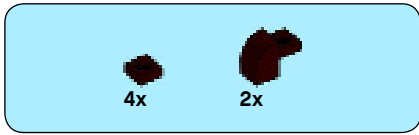

4

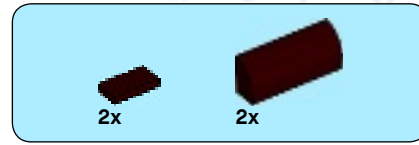
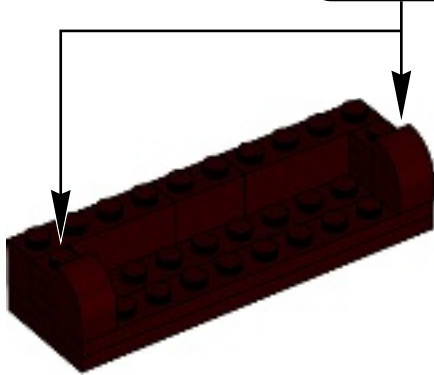
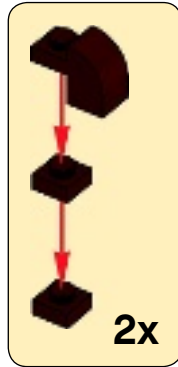

5

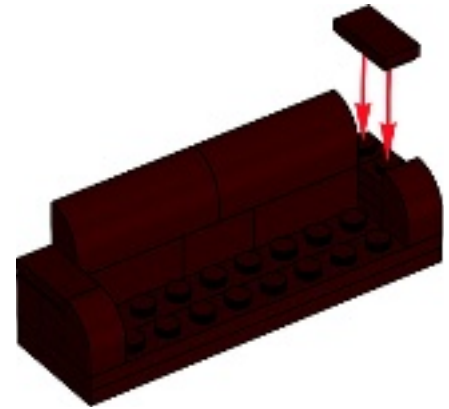

AMY

"Actually, our relationship agreement covers a wide array of scenarios, including career changes, financial instability, intelligent dog uprising."



60



$$= \frac{p^{m+1} - p}{p-2}$$
$$F(p)(p-2)^m$$

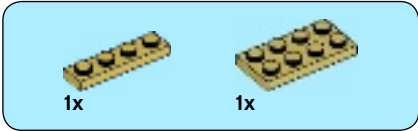
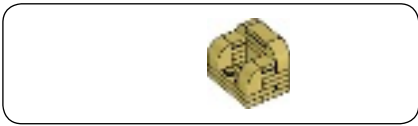

1

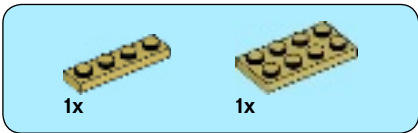
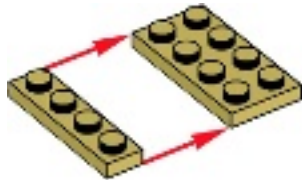

2

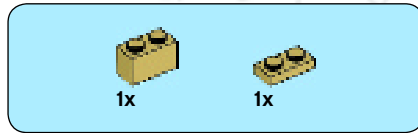
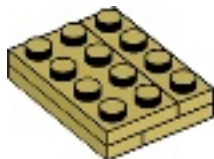

3

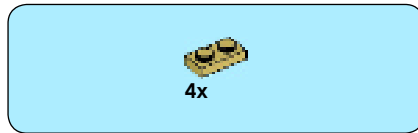
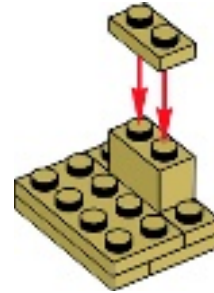

4

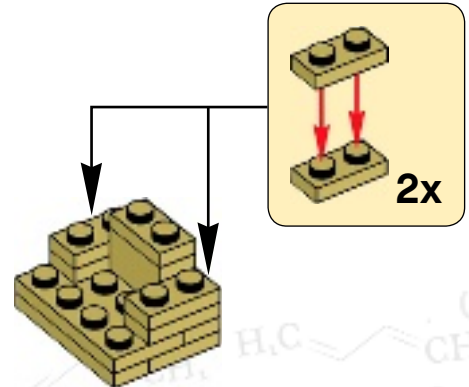



4x

5

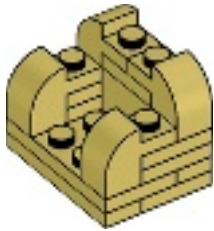

1x



2x

6

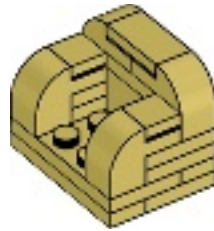

61

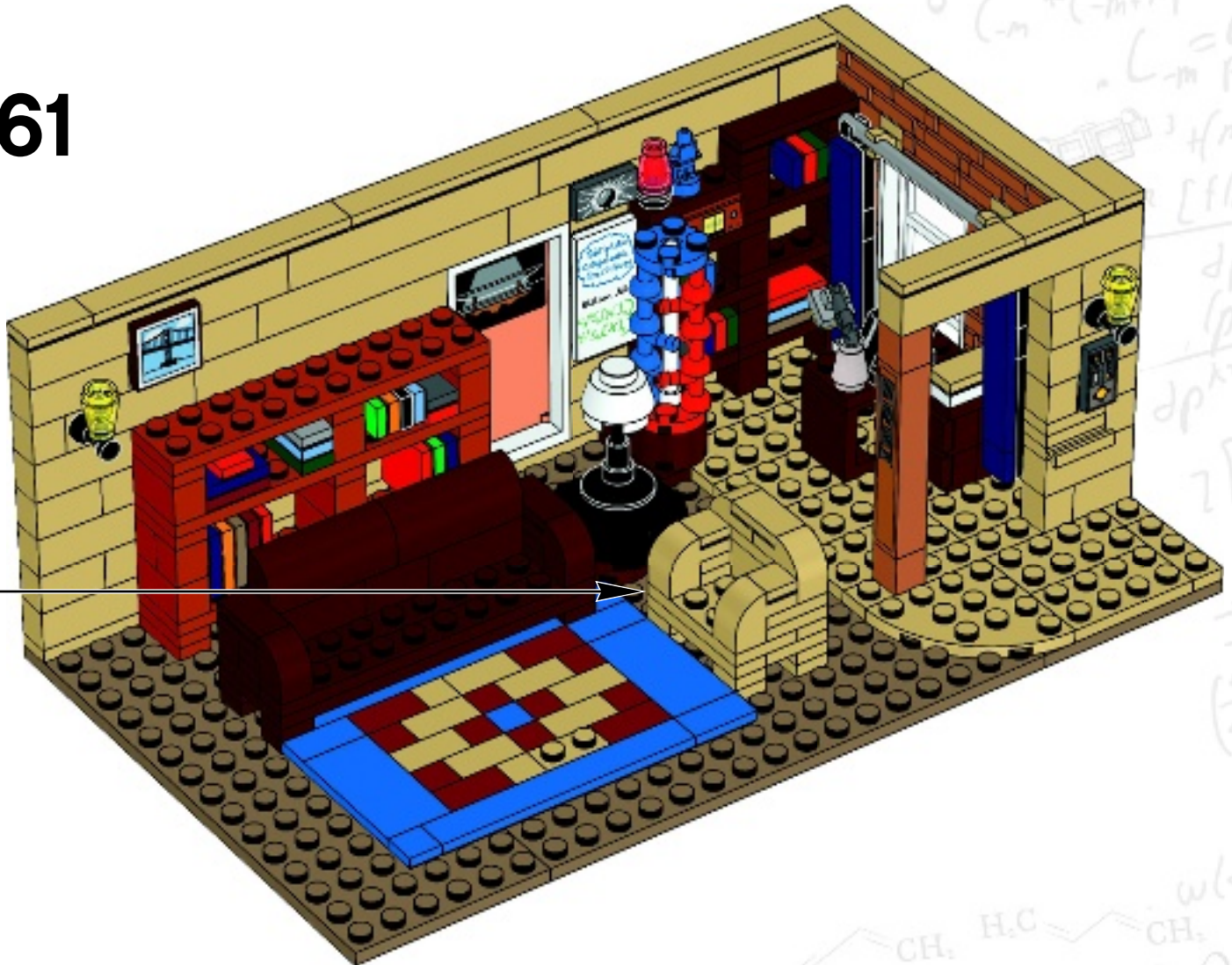

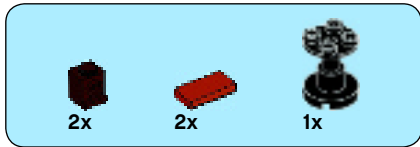

62

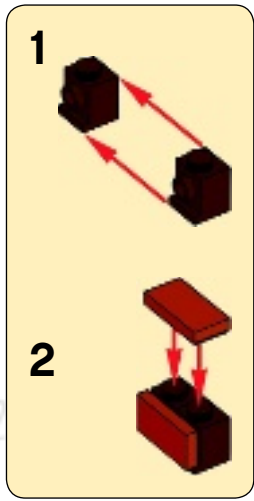

$$-m+1 = p \cdot m$$
$$\frac{p^3}{F(p)(p-2)^m}$$



63

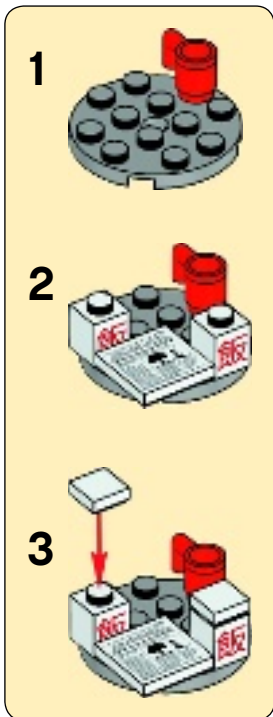

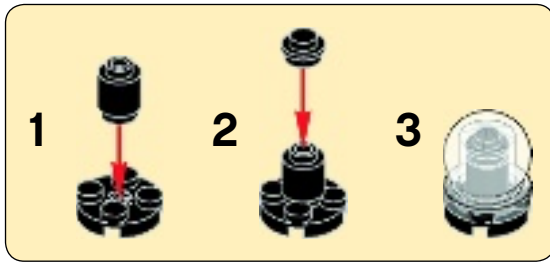
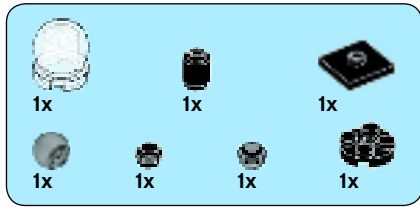

64

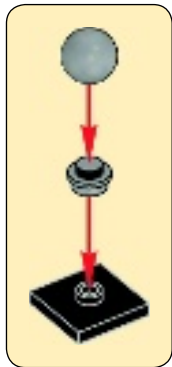

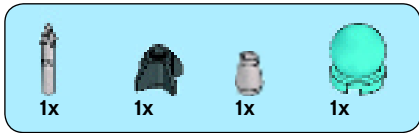

65

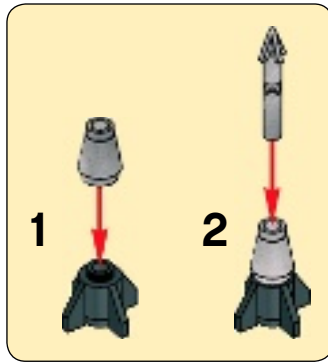

-  1x
-  1x
-  1x
-  1x
-  1x
-  1x

66

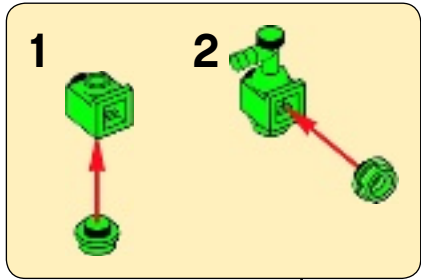

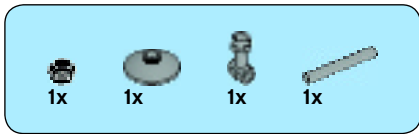

67

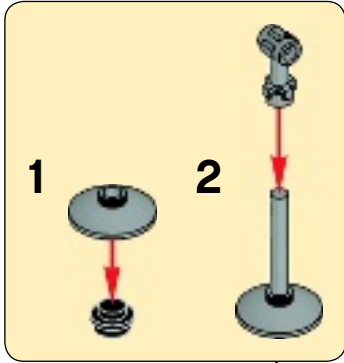



68

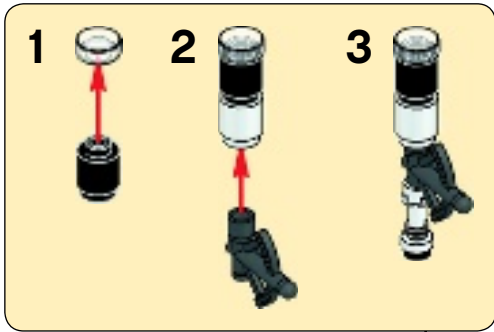

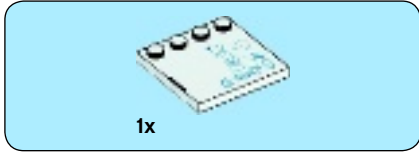

1

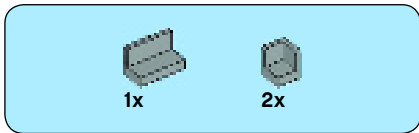
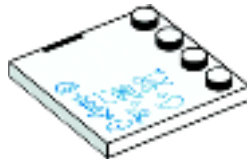

2

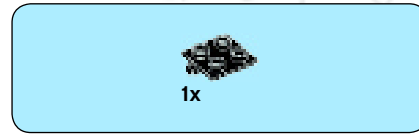
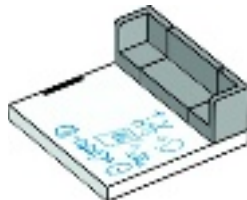

3

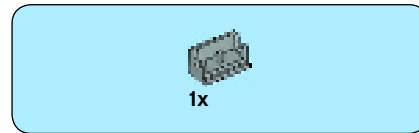
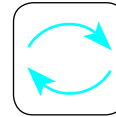

4

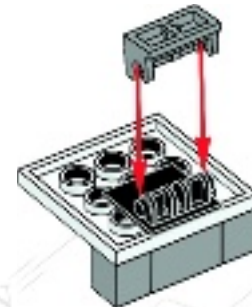

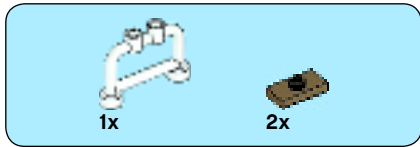

5

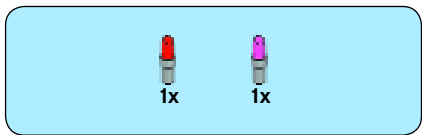
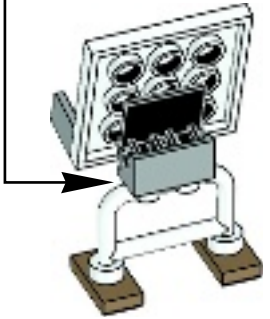
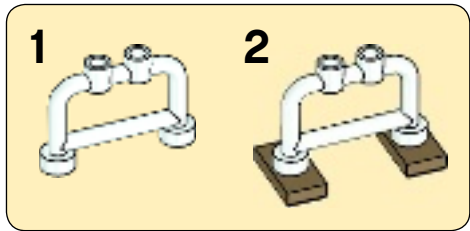

6

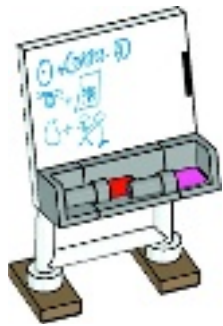
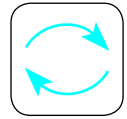

2
-m+1 = p im
(p-d)^m
F(p)(p-d)^m

69



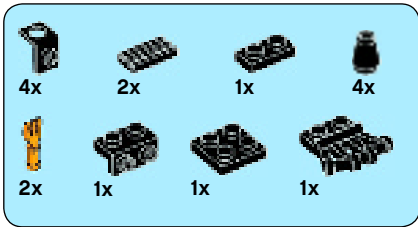

70



1



2



3



Handwritten mathematical notes in the bottom left corner, including the expression $\frac{p^3}{F(p)(p-2)^m}$ and other symbols.

4



5

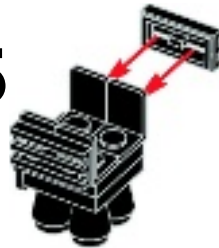

6

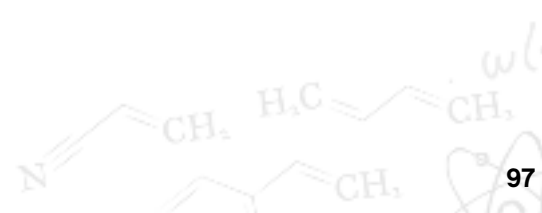

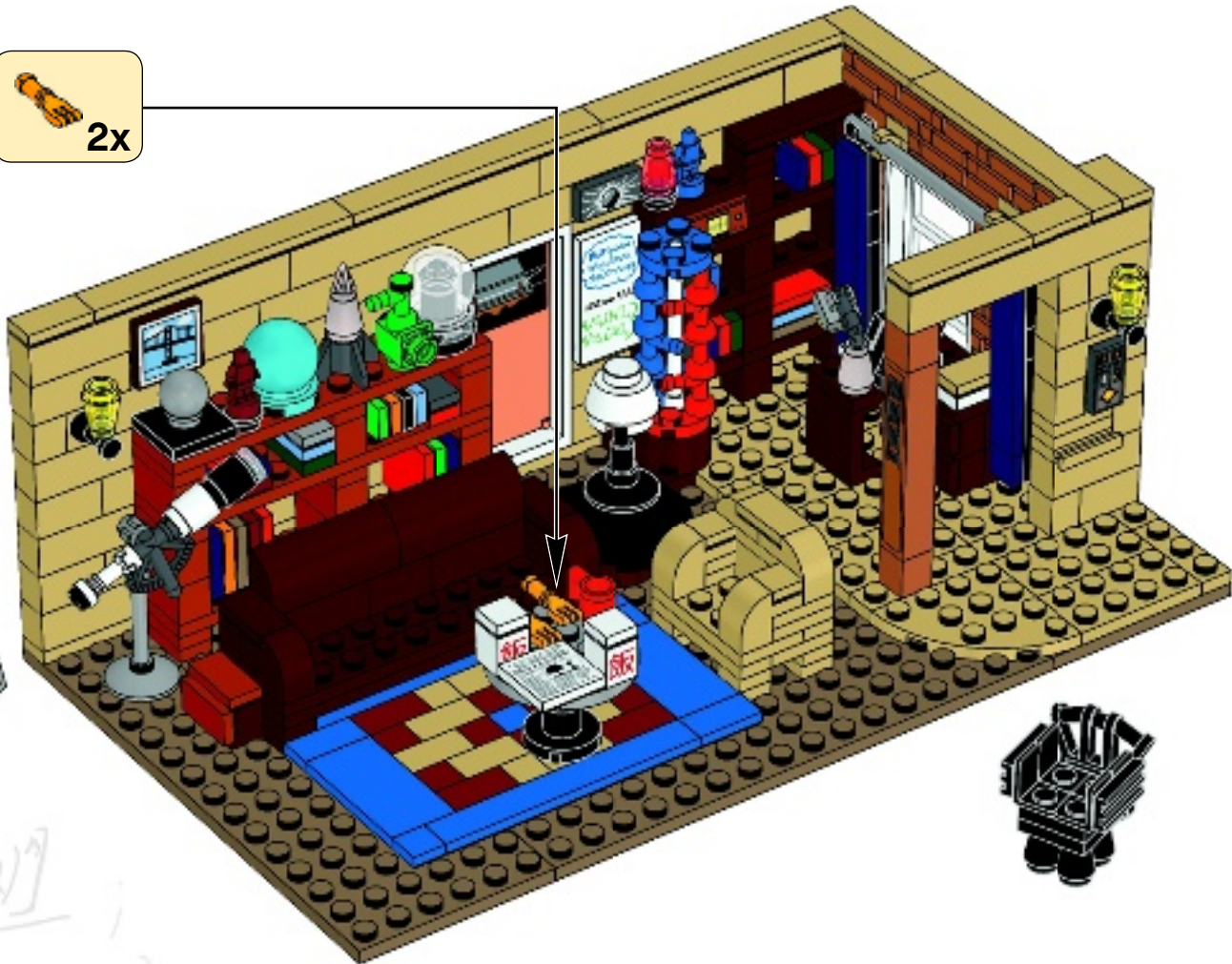

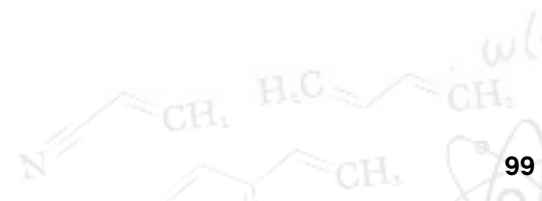

THE DESIGNERS

“Knock knock knock Alatariel, knock knock knock Alatariel, knock knock knock Alatariel...”

Glen Bricker (Glen Wadleigh) had to “pull a Sheldon” for months to convince Alatariel (Ellen Kooijman) that *The Big Bang Theory* LEGO® set she built would make a great LEGO Ideas project. “As a fan of the show I had built the set to have a fun display piece on my shelf. I didn’t think it would stand a chance at being produced, but Glen was certain this would be a hit.”

The real-life scientist (Ellen) and programmer/engineer (Glen), who became friends through the LEGO Ideas platform (formerly Cuusoo), decided to team up and give the popular show they both very much relate to an official tribute in LEGO form. “Our complementary talents enabled a fruitful collaboration, with Glen in charge of minifigure development and project promotion, and me taking care of set design.”





IDEAS

A WHOLE UNIVERSE OF INNOVATIVE LEGO® IDEAS

Do you have an exciting idea for a LEGO® model? Then why not make it into a LEGO Ideas project? You can share your product concept on lego.ideas.com and see what other people think about it.

If your project gains 10,000 supporters, it will automatically qualify for the quarterly LEGO Review. This is where we take an in-depth look at the most popular projects and carefully evaluate them to discover the idea with the most potential. If your project makes it through the review, it will become an official LEGO product.

There are tens of thousands of active members, and thousands of product ideas on LEGO Ideas – several of which have become hit LEGO sets! So take a look, sign up, and support your favorite ideas, or even better: upload your own!

LEGO.COM/IDEAS





1x
6123000



1x
4507543



1x
408301



1x
4541956



1x
306201



1x
6122997



1x
4655208



2x
6122960



1x
6081986



1x
6131659



1x
4646844



1x
4649167



2x
307001



1x
4293350



1x
302301



1x
6040333



13x
4159553



4x
4125253



6x
4124455



2x
4520947



1x
4121921



11x
4579260



1x
4160483

11x
4113917

12x
4114026



1x
4570516



2x
4550324



4x
4544139



4x
4114324



16x
4159774



13x
4162465



12x
4109995



4x
4113233



7x
4113915

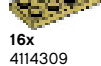

16x
4114309



4x
4273526



1x
6131744



1x
6129450



2x
306921



1x
6079541



1x
403221



1x
389921



4x
459921



1x
6131740



2x
306821



3x
302421



1x
403223



3x
306923



2x
4560180



4x
4206330



2x
416223



4x
459923



1x
4639698



1x
4106556



1x
4650498



1x
6122908



1x
6122885



1x
6122892



1x
6122897



1x
6122911



1x
6122904



1x
6058086



3x
4565320



2x
4162916



3x
4631385



1x
4184108



2x
4252437



2x
4613761



8x
4550169



1x
6107894



4x
4539090



2x
4567332



4x
6020192



1x
6016172



1x
6092585



2x
371026



1x
6106280



1x
4604304



1x
306926



1x
403226



1x
302226



1x
4565323



2x
459926



1x
474026



1x
4538456



2x
4535739



4x
4529236



2x
302426



1x
4124096



1x
4225201



1x
302326



2x
6066102



1x
6055640



2x
241226



1x
306928



1x
4565321



1x
4569058



1x
6122830



1x
4187334

1x
3005748



1x
4654448



1x
6013635



1x
6092599



1x
6129447



1x
6079539



1x
6079542



7x
4579659



4x
4666322



10x
4570877



1x
6122989



2x
4614158



3x
6131797



1x
6129452



1x
6070731



4x
4211483



2x
4215513



1x
4211469



1x
4515351



1x
4514192



1x
4211414



1x
4211512



2x
4211515



2x
4211525



1x
6093527



1x
6071229



1x
4640844



1x
6129445



1x
4624571



1x
4550924



1x
6129848



1x
6129373



1x
6129849



1x
6056836



1x
6065515



1x
6005030



1x
6131630



1x
6078471



2x
6121350



10x
6057986



6x
6055309



1x
6102951



1x
6127667



11x
4656783



1x
6102979



1x
6124846



2x
6013102



3x
6055169



1x
6129522



3x
6092601



1x
4544720



1x
4211029



1x
6129461



1x
4217675



1x
6122993



1x
4212352



4x
4210848



2x
4211044



1x
4221879



1x
4211149



1x
4211186



1x
4211194



2x
6035561

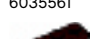

5x
4211190



2x
4211151



3x
4620075



9x
4211242



20x
4221744



1x
4216695



2x
4211166



4x
4211225



2x
6035547



6x
4225469



1x
6064188



1x
6122977



3x
4211152



2x
6092590



1x
6037895

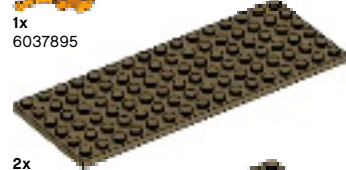

2x
6109751



1x
4613196



3x
4223683



2x
4211214



3x
6092591



2x
4524098



1x
4578032

Customer Service

Kundenservice

Service Consommateurs

Servicio Al Consumidor

LEGO.com/service or dial



: 00800 5346 5555

: 1-800-422-5346