







MARVEL

76260





 **FR**
DONNEZ
OU
RECYCLEZ

 OU  OU 
ASSOCIATION MAGASIN DÉCHÈTERIE

Adresses sur quefairedemesdechets.fr



LEGO.com/sustainable-packaging



BUILDER



Apple and the Apple logo are trademarks of Apple Inc., registered in the U.S. and other countries and regions. App Store is a service mark of Apple Inc. Google Play and the Google Play logo are trademarks of Google LLC. Tencent and the Tencent logo are trademarks of Tencent Inc.

🔍 LEGO.com/devicecheck

EN Ask parents' permission before going online | **DE** Eltern um Erlaubnis bitten, bevor du online gehst | **FR** Demande l'autorisation d'un parent avant d'aller en ligne | **IT** Chiedi il permesso ai tuoi genitori prima di andare online | **ES** Pídeles permiso a tus papás antes de conectarte a Internet | **PT** Peça autorização aos pais antes de acederes online | **ZH** 上网前应先征得父母的同意 | **PL** Poproś rodziców o zgodę, zanim wejdiesz do Internetu | **CS** Než půjdeš na internet, požádej rodiče o svolení | **SK** Skôr než pôjdeš na internet, vypýtaj si povolenie od rodičov | **HU** Kérj szülői engedélyt, mielőtt online csatlakoznál! | **RO** Cere permisiunea părinților înainte de a te conecta online | **BG** Поискайте разрешение от родител, преди да влезете онлайн | **LV** Pirms došanās tiešsaistē palūdz atļauju vecākiem | **ET** Enne Interneti kasutamist küsi vanematelt luba | **LT** Prieš prisijungdami prie interneto, atsiklauskite tėvų





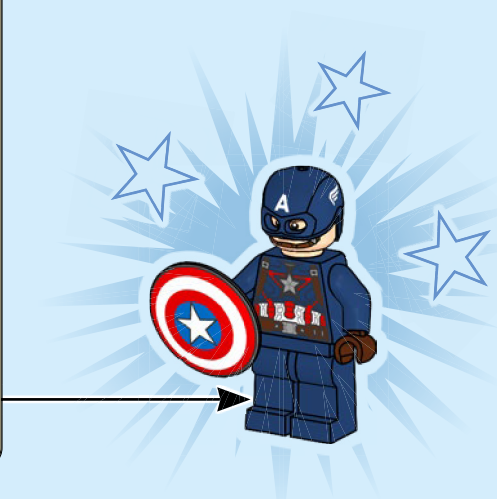
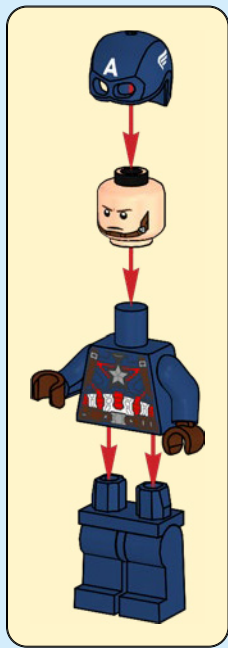

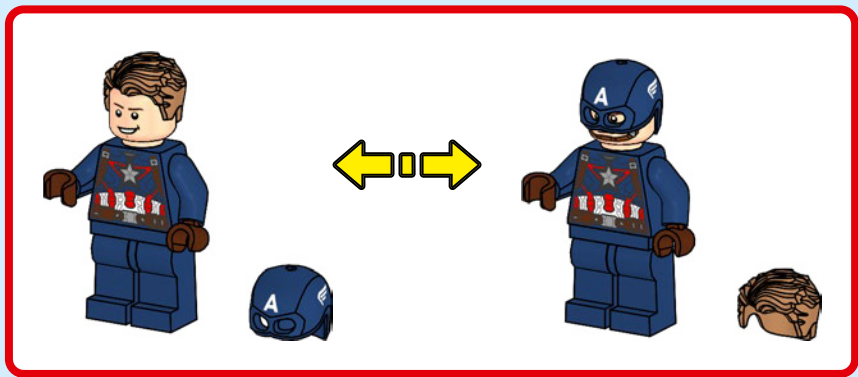



1x

1

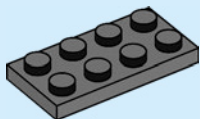

1x

2

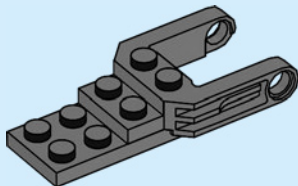

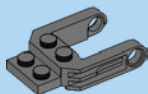

1x

3

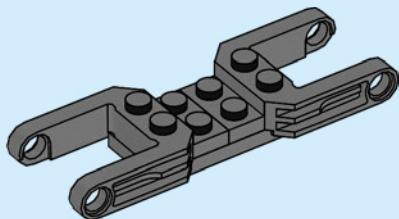

8





2x

4

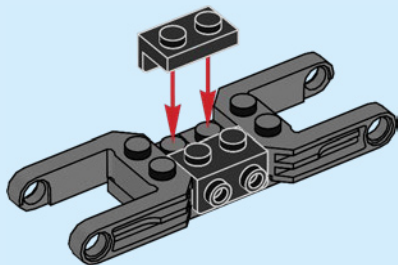

2x

5

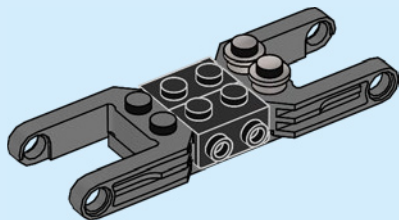



2x



2x

6

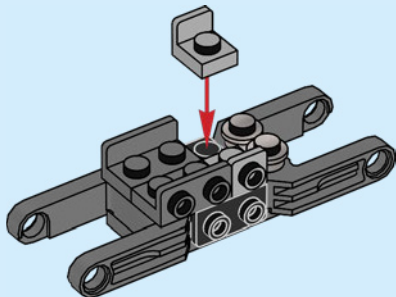

10



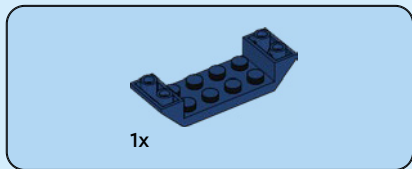

7

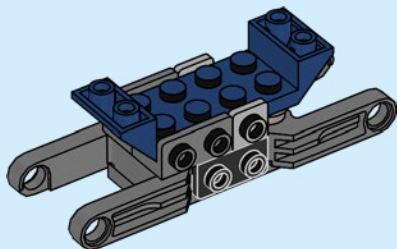



2x

8

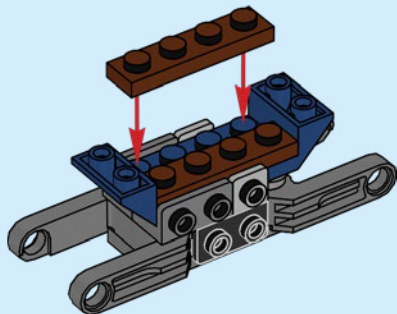



2x

9

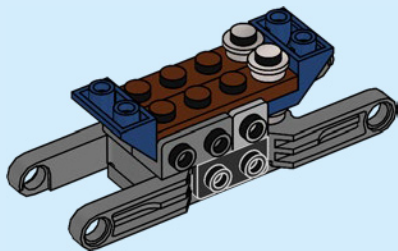



1x

10

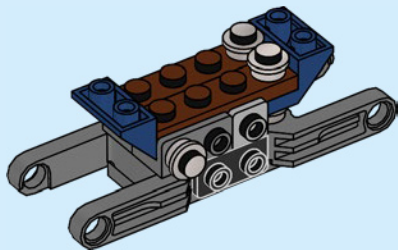

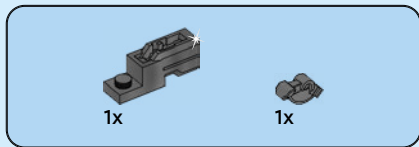

11

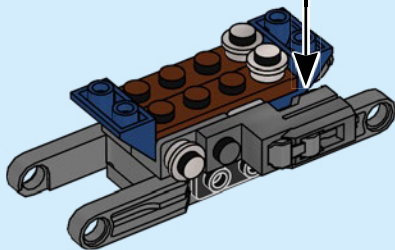
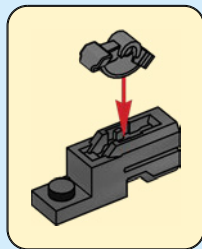



1x

12

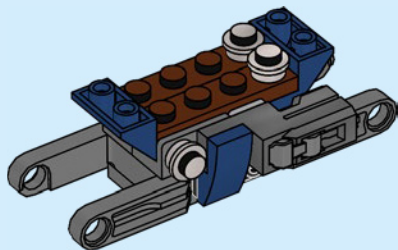



1x

13

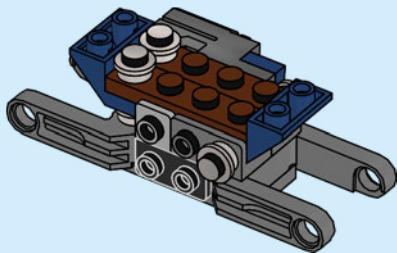

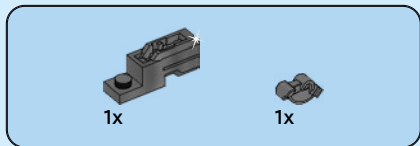

14

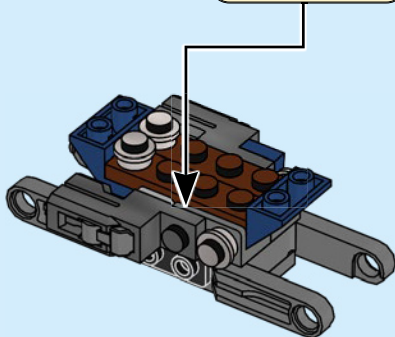
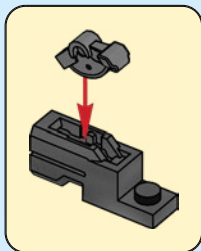



1x

15

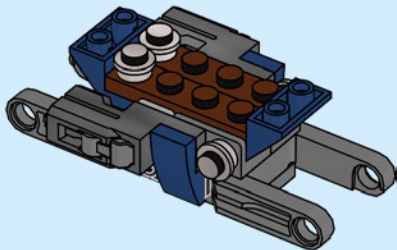



2x

16

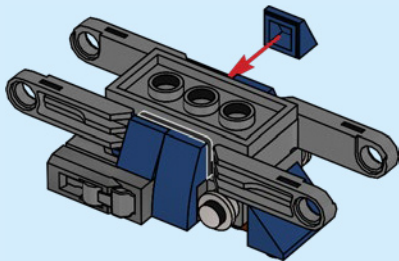



2x

17

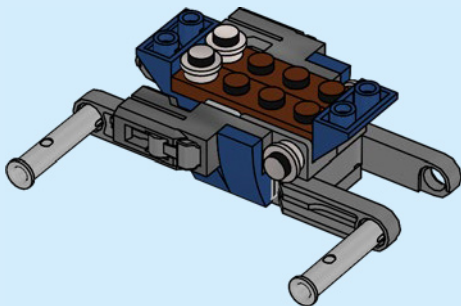
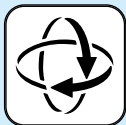

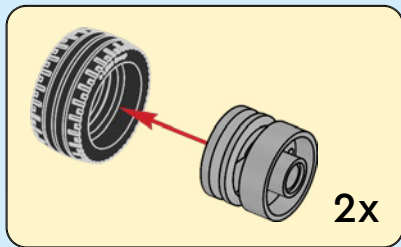
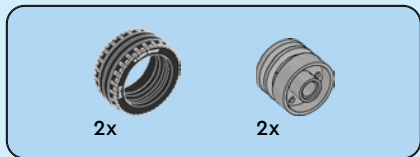

18

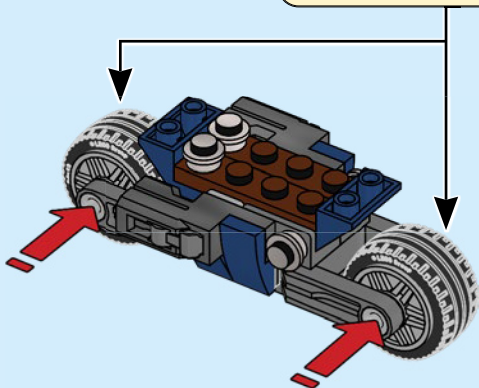



2x

19

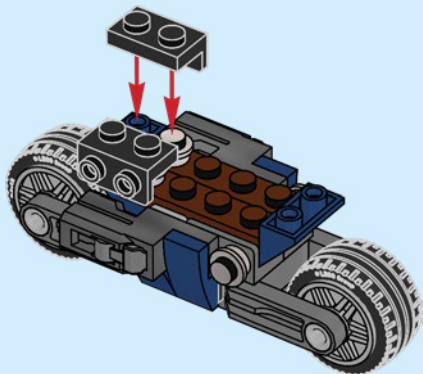



2x

20

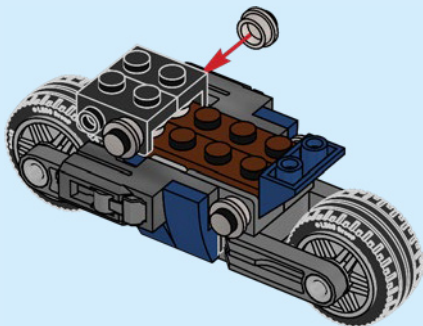



2x

21

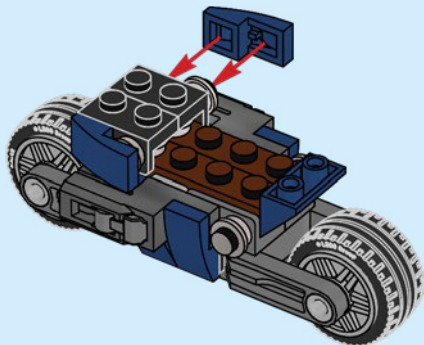



1x

22

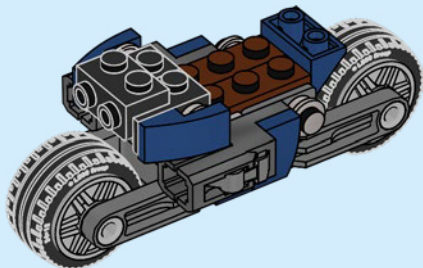



1x



1x



1x

23

1



2

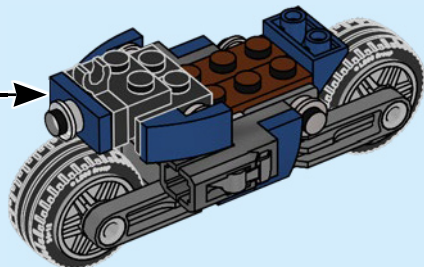

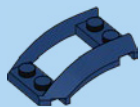

1x

24

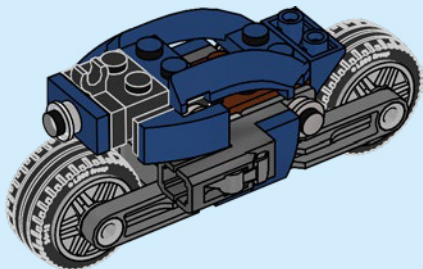



2x



1x

25

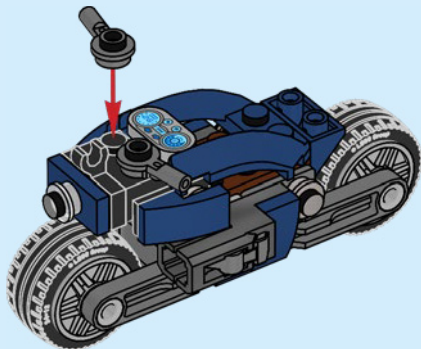

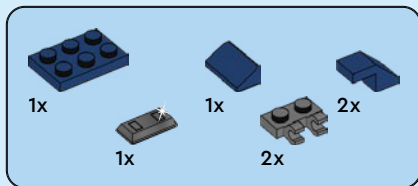

26

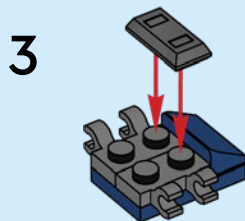
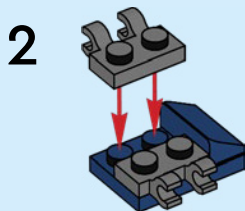
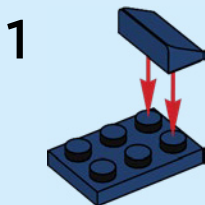

4

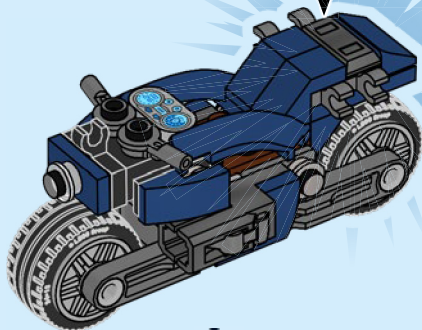
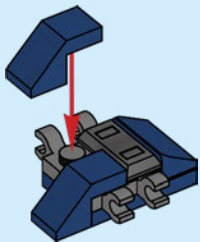



2x



2x

27

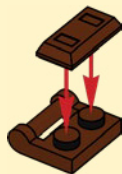

2x

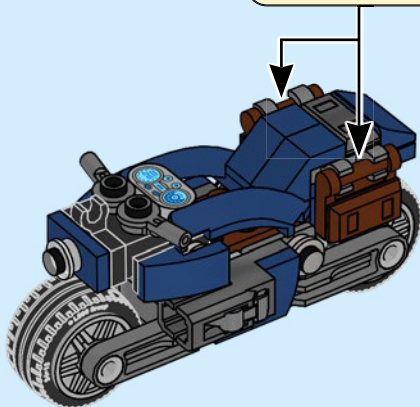



4x

28

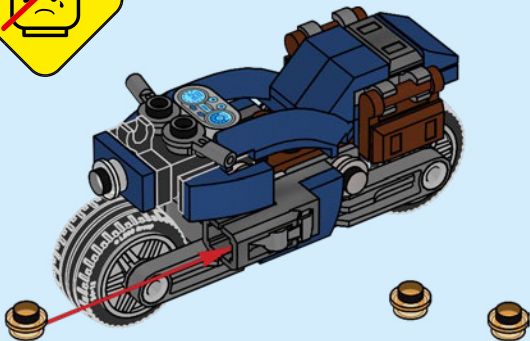

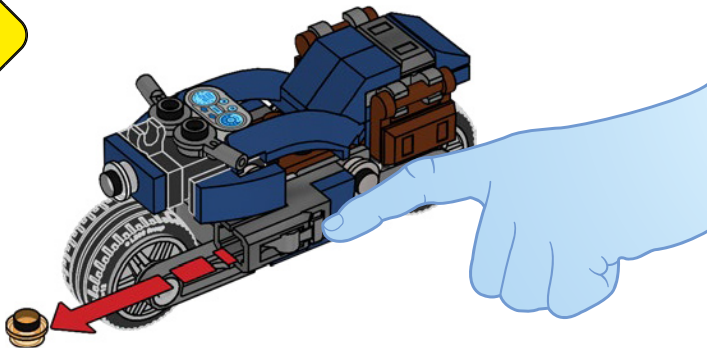



YOU COULD

WIN



Scan this QR code or go to
LEGO.COM/PRODUCTFEEDBACK and give us
your short feedback about this LEGO® set
for a chance to win a cool LEGO prize.

Terms and Conditions apply*

EN: YOU COULD WIN. Terms and Conditions apply* **DE: Du könntest GEWINNEN.** Es gelten die Teilnahmebedingungen* **FR: Tu pourrais GAGNER.** Des conditions s'appliquent* **IT: Potresti VINCERE tu.** Termini e condizioni sono applicabili* **ES: Puedes GANAR.** Aplican términos y condiciones* **PT: Poderá GANHAR.** Aplicam-se termos e condições* **ZH: 轻松获奖. 条款和条件适用*** **PL: Szansa na WYGRANĄ.** Obowiązują warunki korzystania* **CS: Máte šanci VYHRÁT.** Platí všeobecné smluvní podmínky* **SK: Máte šancu VYHRÁT.** Platia všeobecné zmluvné podmienky* **HU: TE IS NYERHETSZ.** Felhasználási feltételek érvényesek* **RO: Ai putea CÂȘTIGA.** Se aplică termenii și condiții* **BG: Можете да СПЕЧЕЛИТЕ.** Има определени правила и условия* **LV: Tu vari LAIMĒT.** Ir spēkā noteikumi un nosacījumi.* **ET: Sul on võimalus VÕITA.** Kehtivad tingimused* **LT: Jūs galite LAIMĖTI.** Taikomos sąlygos*

*[LEGO.com/productfeedback-terms](https://www.lego.com/productfeedback-terms)

LEGO and the LEGO logo are trademarks of the LEGO Group.
©2023 The LEGO Group. ©2023 MARVEL

6490640



MARVEL

76260



2



LEGO.com/sustainable-packaging



BUILDER



Apple and the Apple logo are trademarks of Apple Inc., registered in the U.S. and other countries and regions. App Store is a service mark of Apple Inc. Google Play and the Google Play logo are trademarks of Google LLC. Tencent and the Tencent logo are trademarks of Tencent Inc.

 [LEGO.com/devicecheck](https://www.lego.com/devicecheck)

EN Ask parents' permission before going online | **DE** Eltern um Erlaubnis bitten, bevor du online gehst | **FR** Demande l'autorisation d'un parent avant d'aller en ligne | **IT** Chiedi il permesso ai tuoi genitori prima di andare online | **ES** Pídeles permiso a tus papás antes de conectarte a Internet | **PT** Peça autorização aos pais antes de acederes online | **ZH** 上网前应先征得父母的同意 | **PL** Poproś rodziców o zgodę, zanim wejdiesz do Internetu | **CS** Než půjdeš na internet, požádej rodiče o svolení | **SK** Skôr než pôjdeš na internet, vypýtaj si povolenie od rodičov | **HU** Kérj szülői engedélyt, mielőtt online csatlakoznál! | **RO** Cere permisiunea părinților înainte de a te conecta online | **BG** Поискайте разрешение от родител, преди да влезете онлайн | **LV** Pirms došanās tiešsaistē palūdz atļauju vecākiem | **ET** Enne Interneti kasutamist küsi vanematelt luba | **LT** Prieš prisijungdami prie interneto, atsiklauskite tėvų





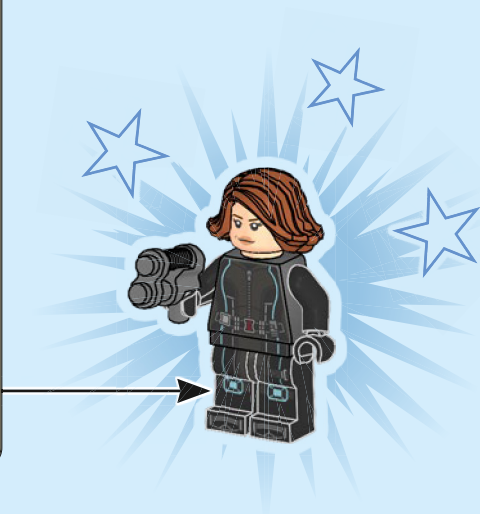
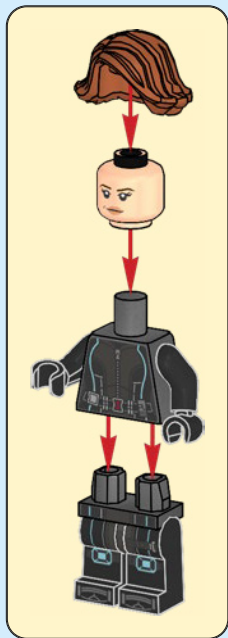



1x

1

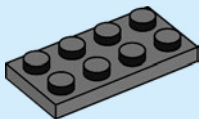

6



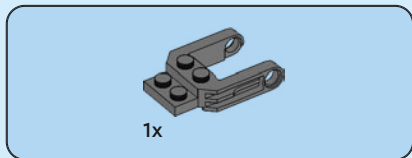

2

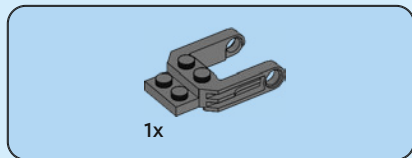
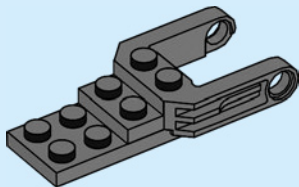

3

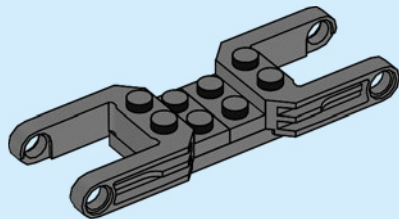



2x

4

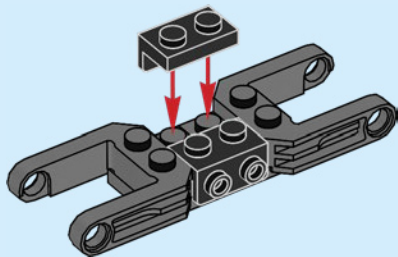

8





1x

5

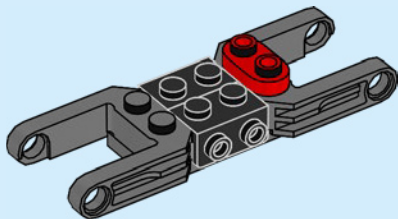



2x



2x

6

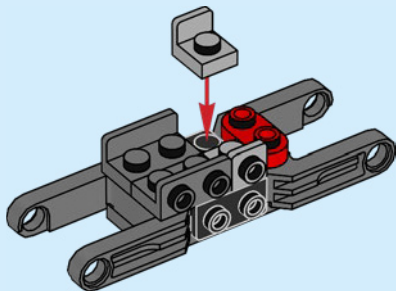

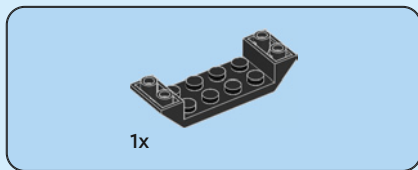

7

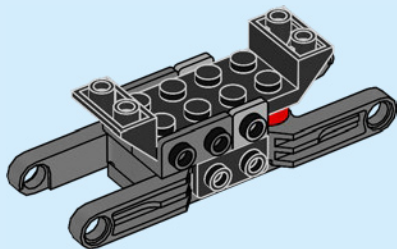



1x

8

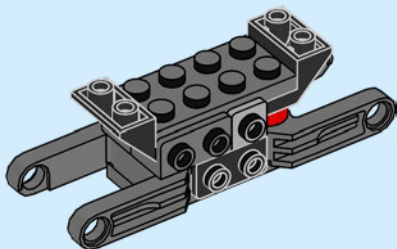



1x

9

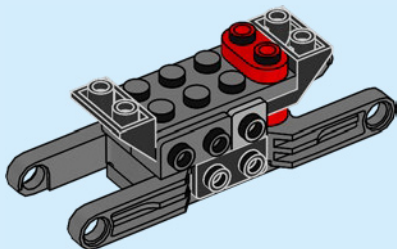



1x

10

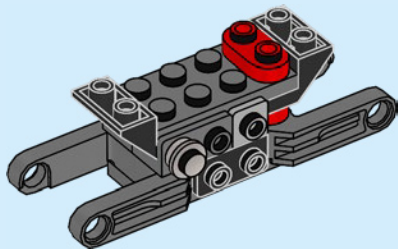

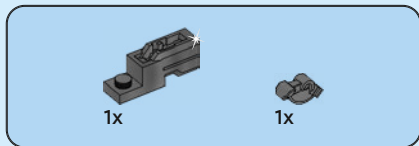

11

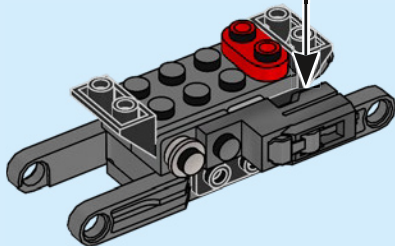
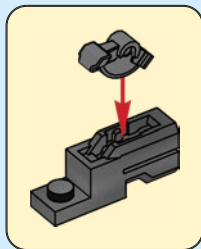



1x

13

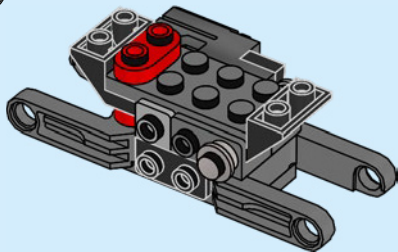

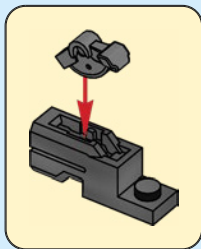
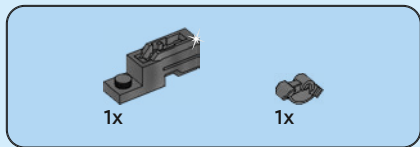

14

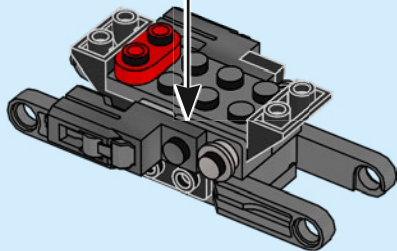



1x

15

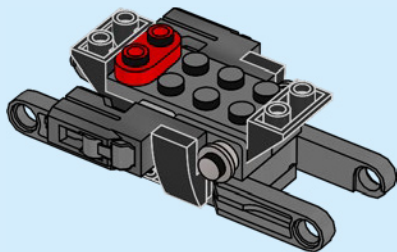



2x

16

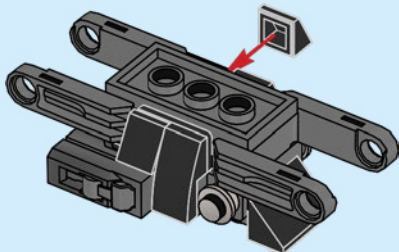
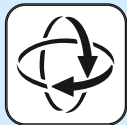



2x

17

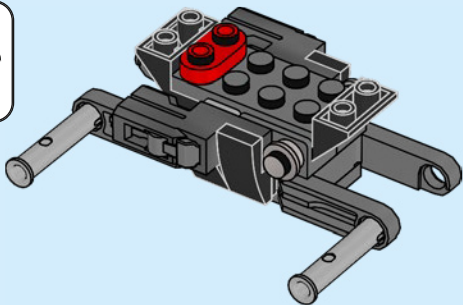

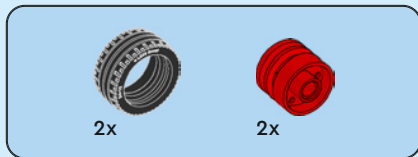

18

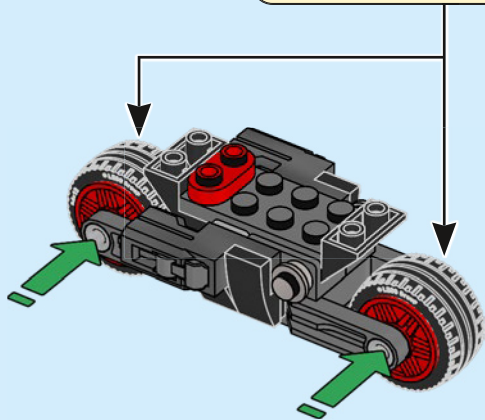
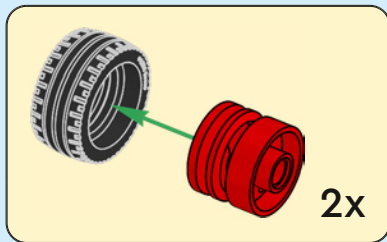



2x

19

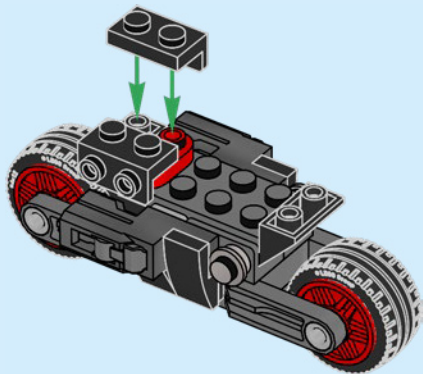



2x

20

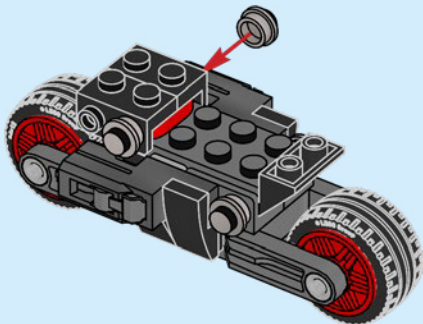



2x

21

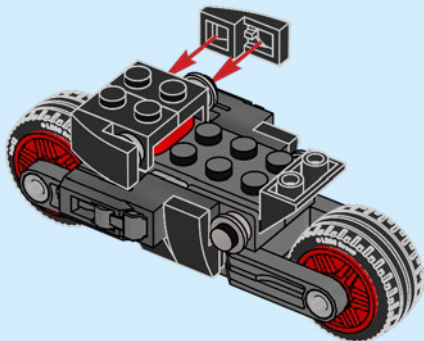



1x

22

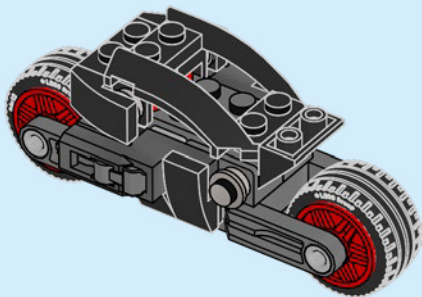



1x



1x

23

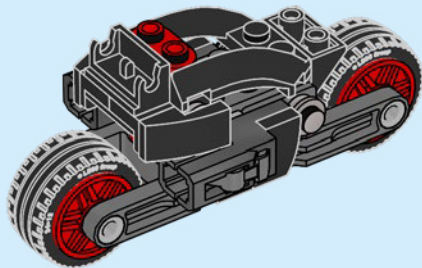

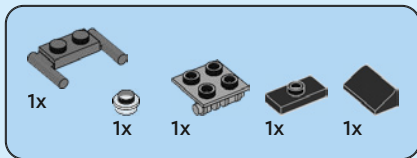

24

1

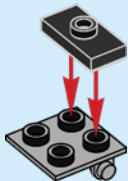

2

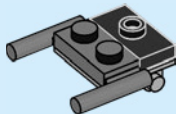

3

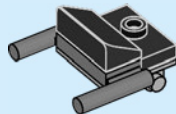

4

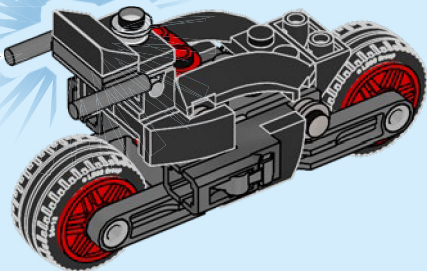
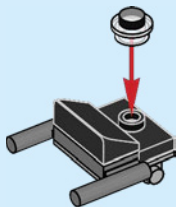

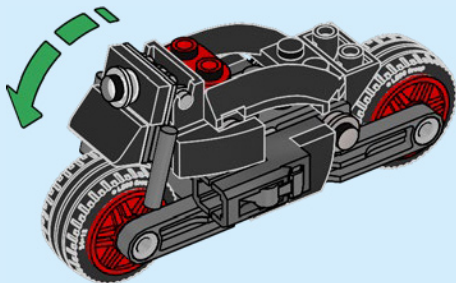



2x

25

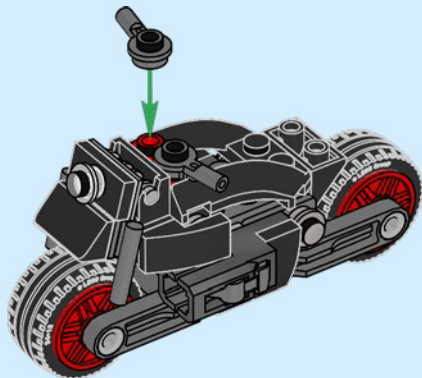

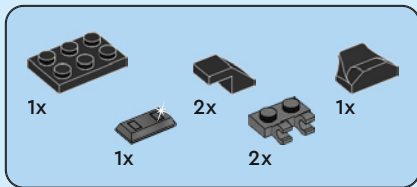

26

1

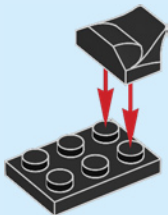

2

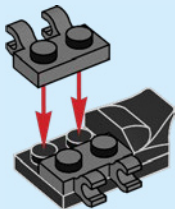

3

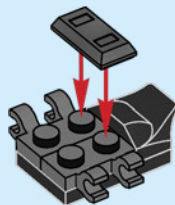

4

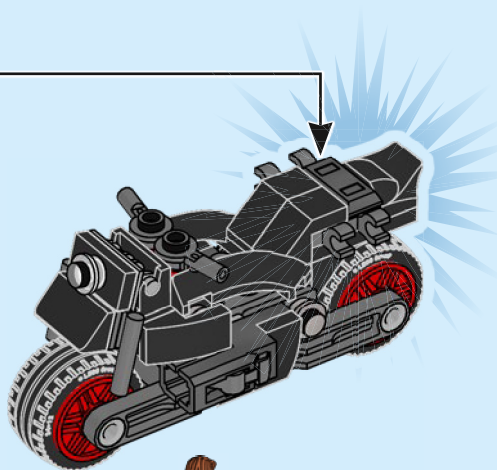
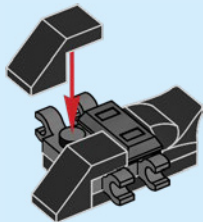



2x

27

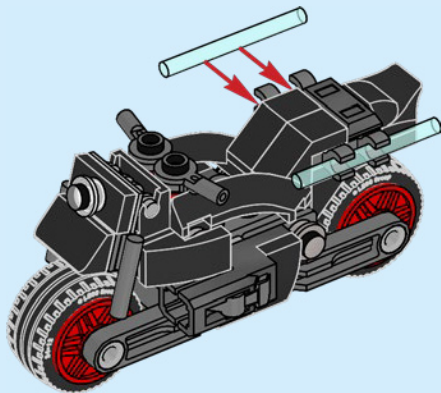



4x

28

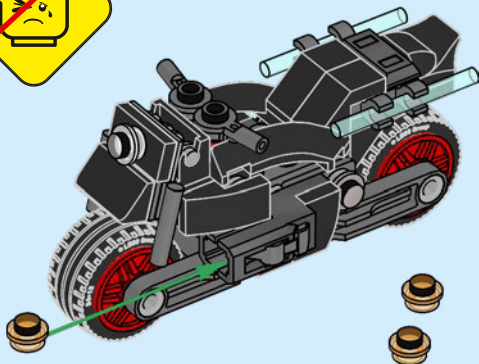

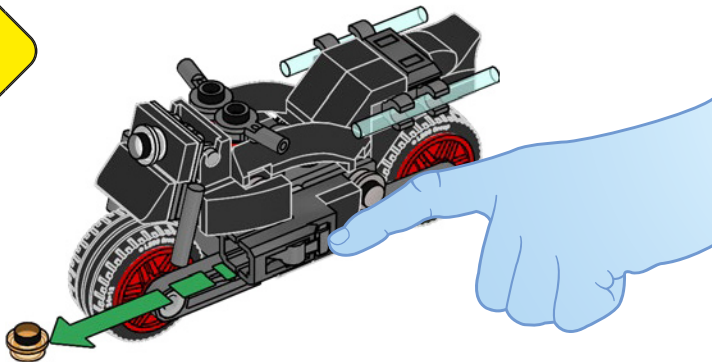





2x
4504382



1x
4548180



1x
6313116



9x
6016172



2x
6267487



4x
6047276



1x
393726



1x
302126

38



1x
6092585



1x
6375706



4x
6102596



1x
4525236



1x
6131571



3x
4211065



4x
6338470



4x
6000606



4x
6350292



4x
6360675



4x
6388118



1x
4623236



1x
4263176



1x
6447635



1x
6444161



2x
6261744



2x
6236915



2x
4211190



4x
6335328



2x
6109684



1x
4211881



4x
6338962



1x
6444162



2x
6170187



2x
4504374



1x
6216905



4x
6094143



2x
6166857



1x
6092588



1x
4530028



1x
6251246



1x
6251249



1x
6315642



1x
6357647



1x
4162916



1x
6261471



3x
6210269



2x
6256881



2x
6208447



4x
6345952



12x
4633691



1x
6115306



1x
6145528



1x
6288611



1x
6163442



8x
6240227



2x
6240030



[LEGO.com/service](https://www.LEGO.com/service)



LEGO and the LEGO logo are trademarks of the LEGO Group.
©2023 The LEGO Group. ©2023 MARVEL. 6467940

Rebuild
the
world™

