



SONIC™

THE HEDGEHOG

76990





 **FR**
DONNEZ
OU
RECYCLEZ

 OU  OU 

ASSOCIATION MAGASIN DÉCHÈTERIE

Adresses sur quefairedemesdechets.fr



LEGO.com/sustainable-packaging



BUILDER



Apple and the Apple logo are trademarks of Apple Inc., registered in the U.S. and other countries and regions. App Store is a service mark of Apple Inc. Google Play and the Google Play logo are trademarks of Google LLC. Tencent and the Tencent logo are trademarks of Tencent Inc.

Q [LEGO.com/devicecheck](https://www.lego.com/devicecheck)

EN Ask parents' permission before going online | **DE** Eltern um Erlaubnis bitten, bevor du online gehst | **FR** Demande l'autorisation d'un parent avant d'aller en ligne | **IT** Chiedi il permesso ai tuoi genitori prima di andare online | **ES** Pídeles permiso a tus papás antes de conectarte a Internet | **PT** Pede autorização aos pais antes de acederes online | **ZH** 上网前应先征得父母的同意 | **PL** Poproś rodziców o zgodę, zanim wejdiesz do Internetu | **CS** Než půjdeš na internet, požádej rodiče o svolení | **SK** Skôr než pôjdeš na internet, vypýtaj si povolenie od rodičov | **HU** Kérj szülői engedélyt, mielőtt online csatlakoznál! | **RO** Cere permisiunea părinților înainte de a te conecta online | **BG** Поискайте разрешение от родител, преди да влезете онлайн | **LV** Pirms došanās tiešsaistē palūdz atļauju vecākiem | **ET** Enne Interneti kasutamist küsi vanematelt luba | **LT** Prieš prisijungdami prie interneto, atsilkauskite tėvų

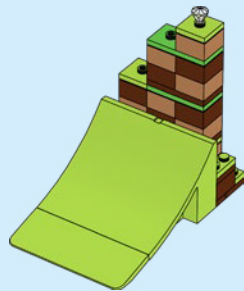
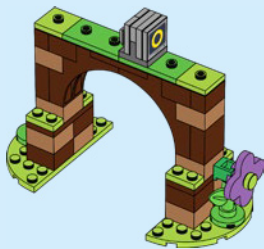
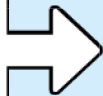
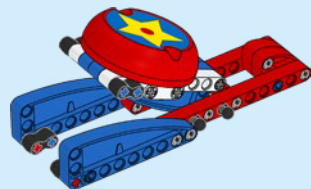
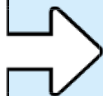

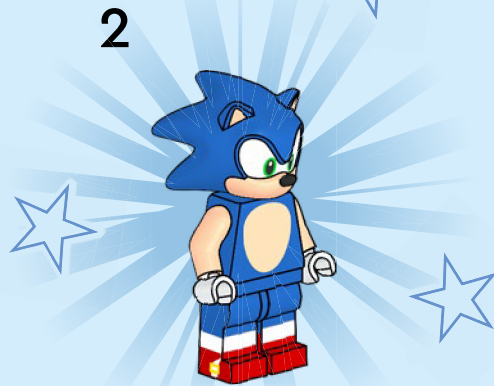
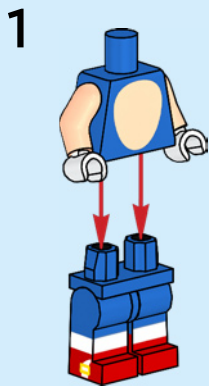

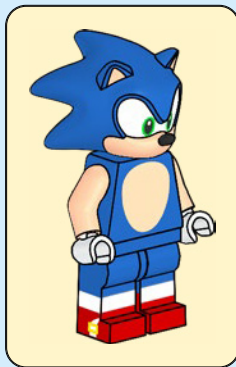
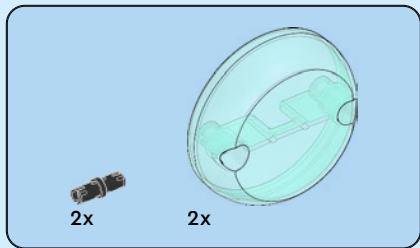

1

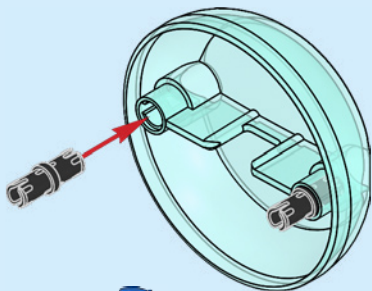

2



3

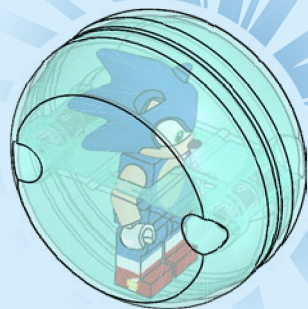

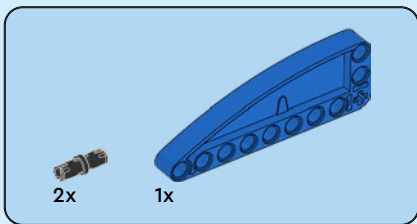
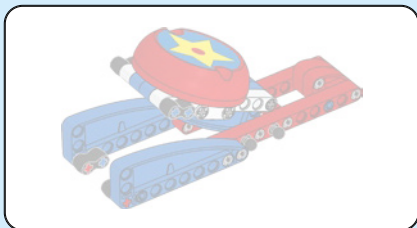

1

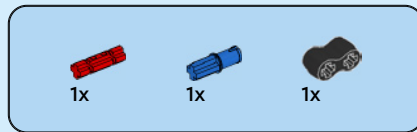
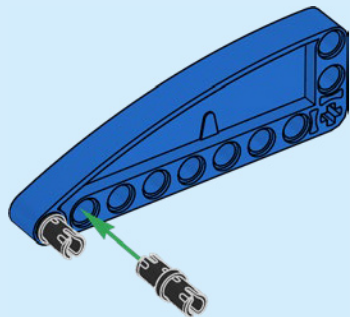

2

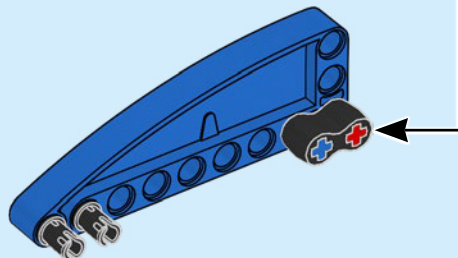
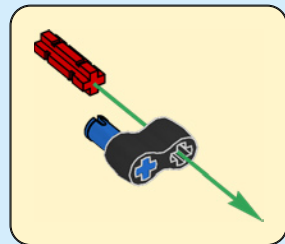

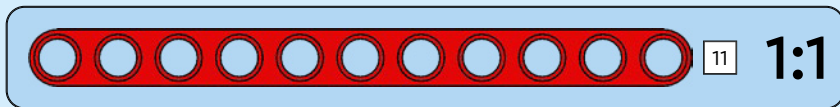
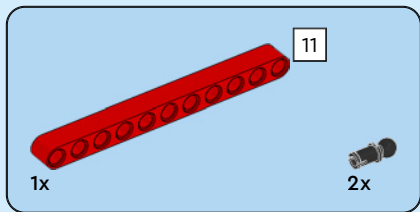

3

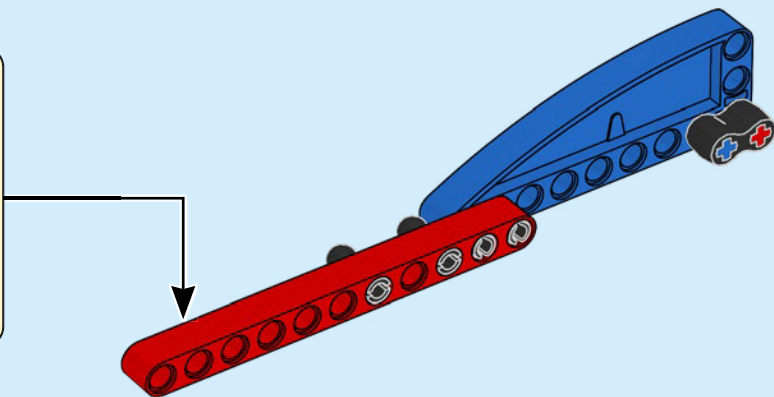
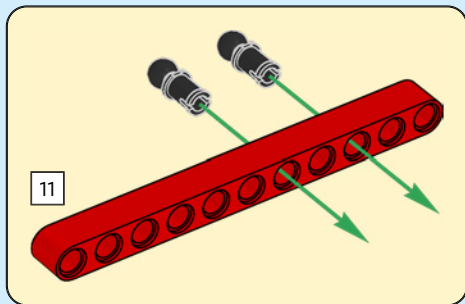

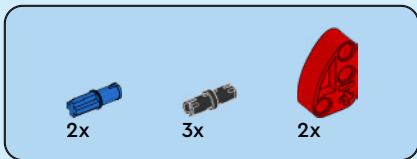

4

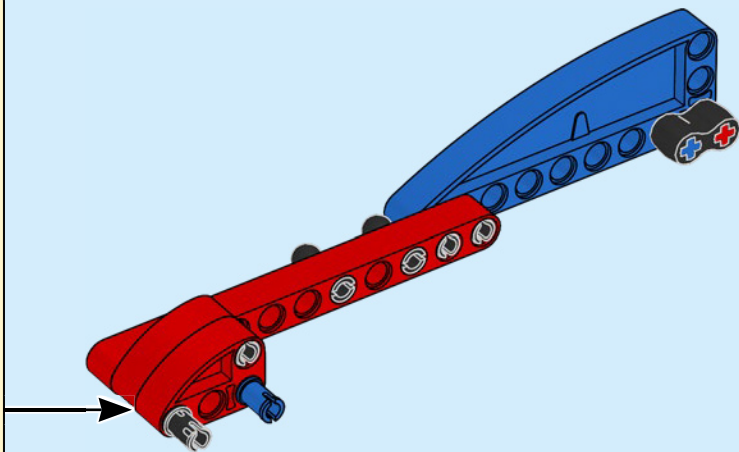
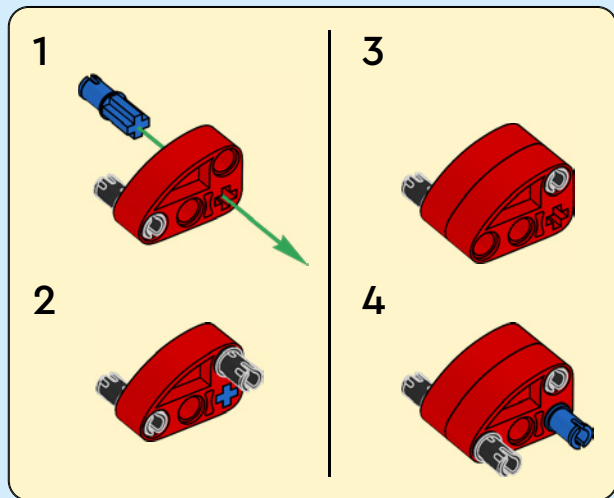

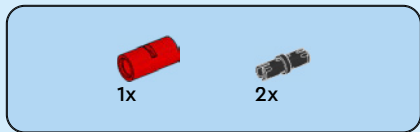

5

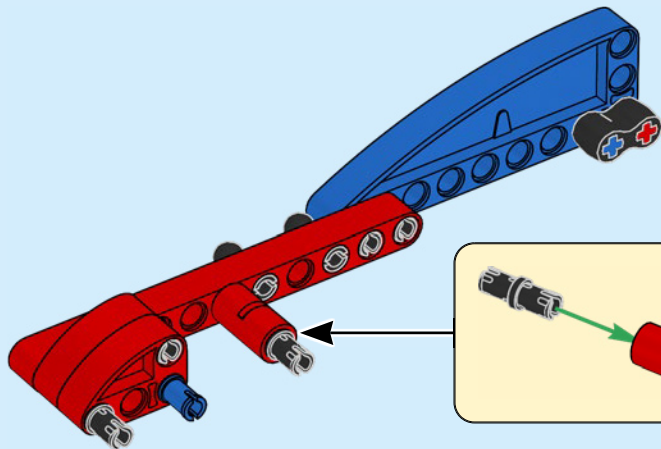

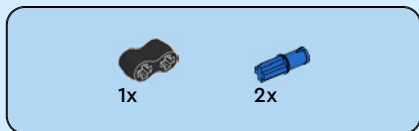
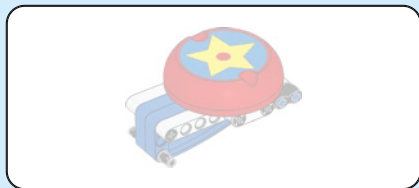

1x

2x

6

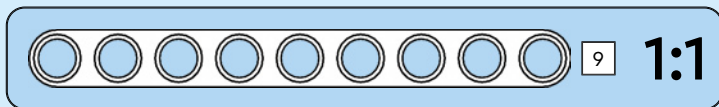
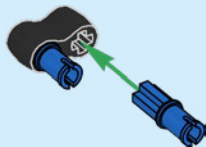

9

1:1

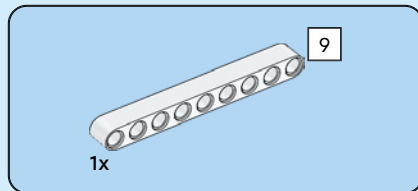

9

1x

7

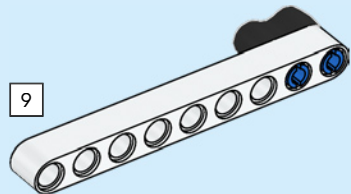

9

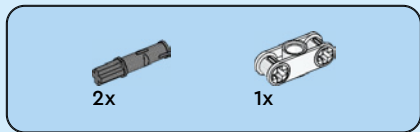

8

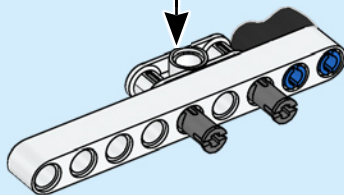
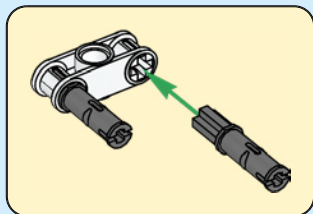

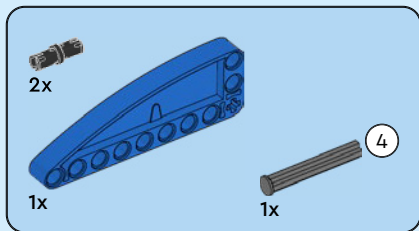

9

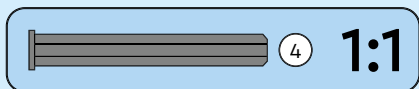
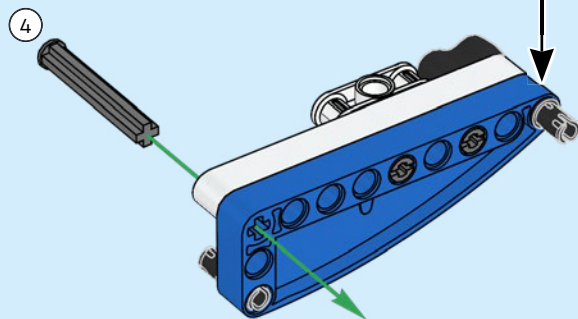
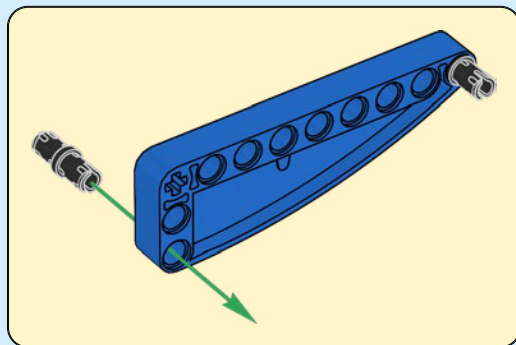

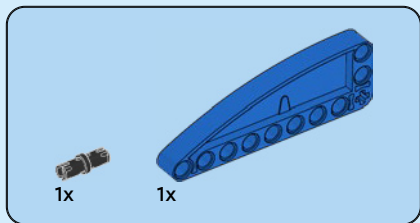

10

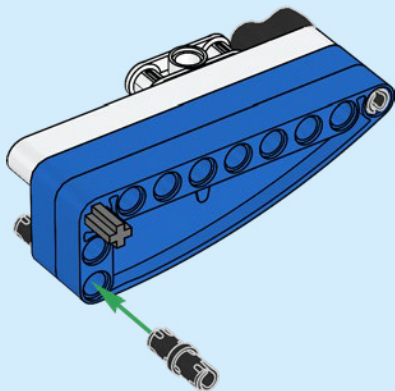

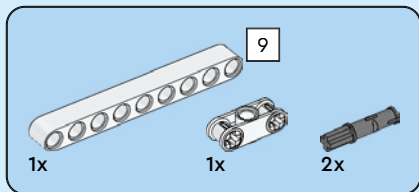

11

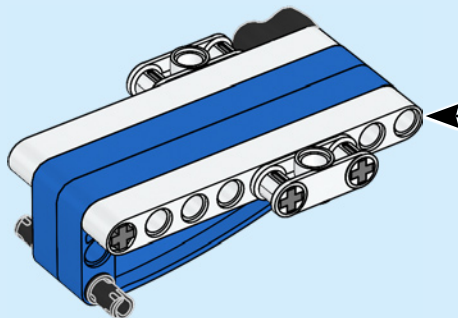
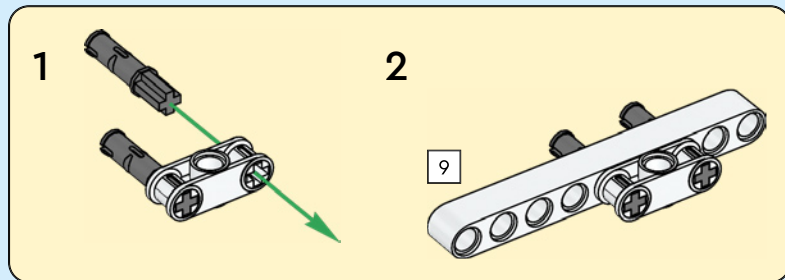
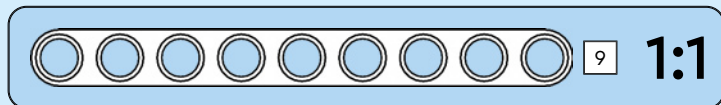



1x



2x

12

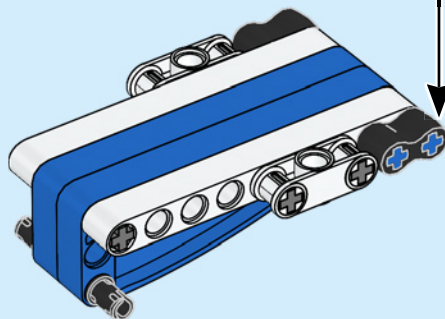
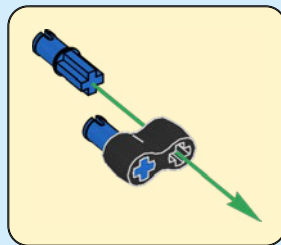

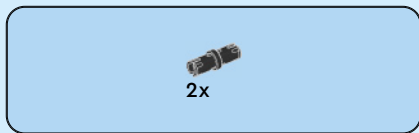

13

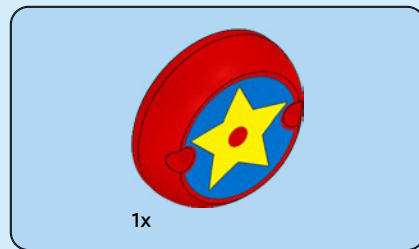
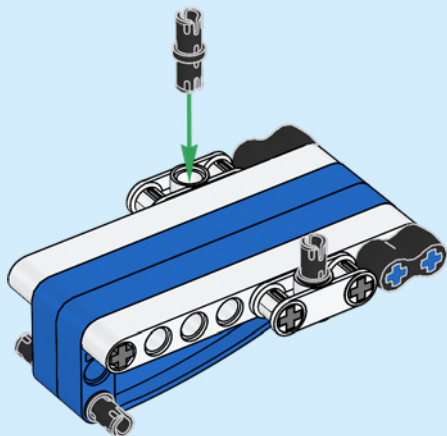

14

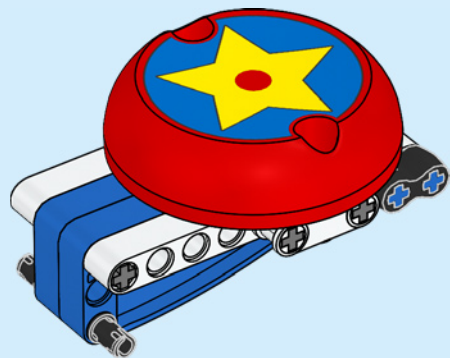

15

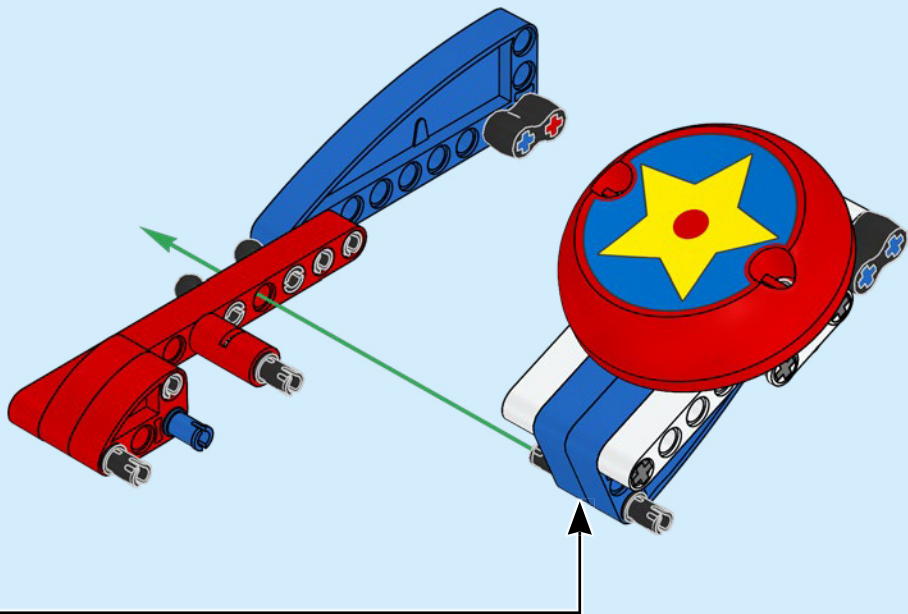

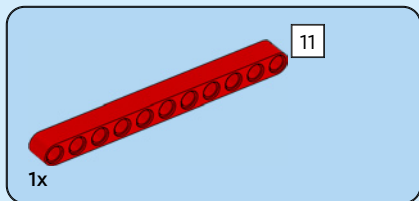

16

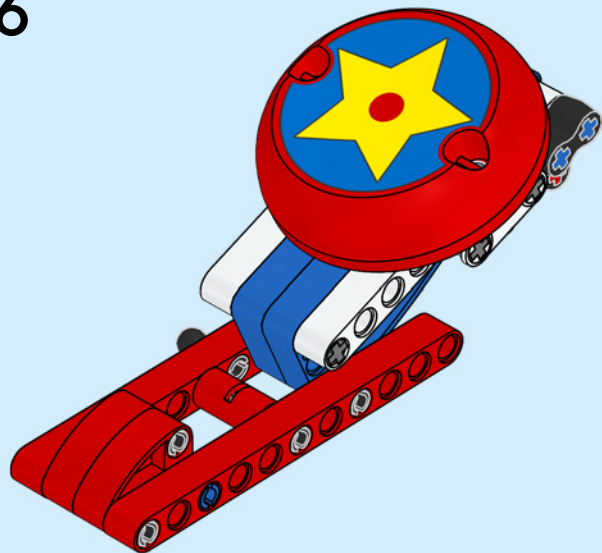

11

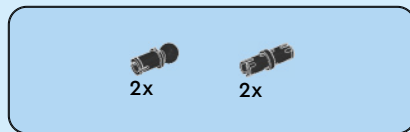

17

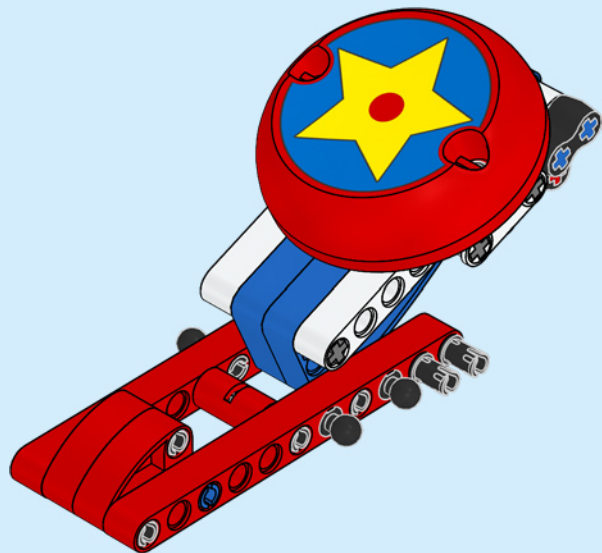

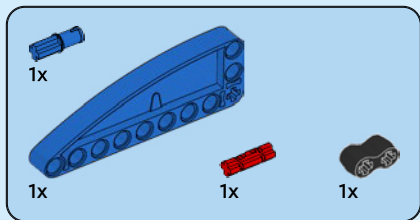

18

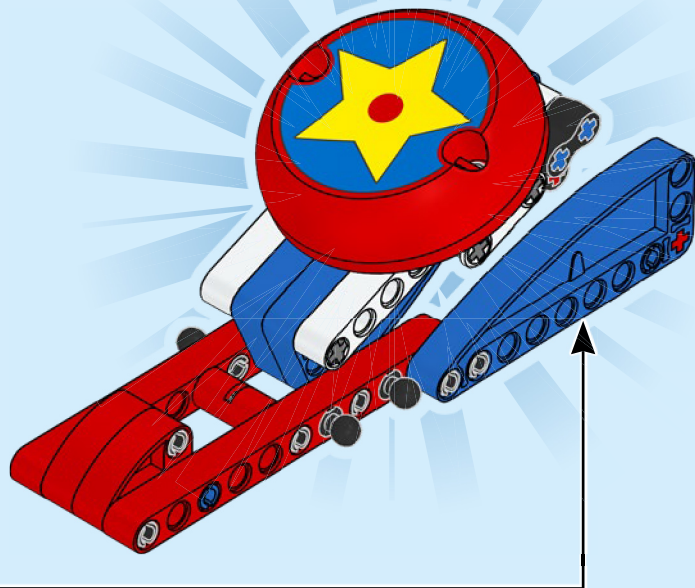
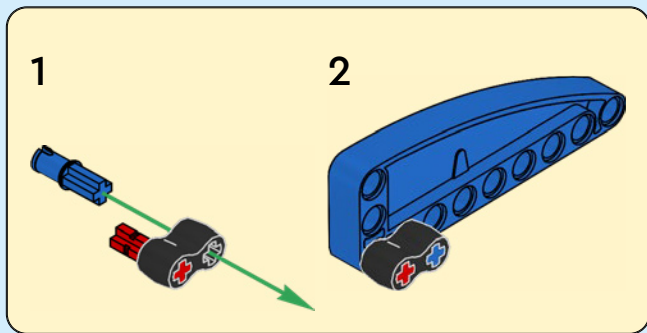

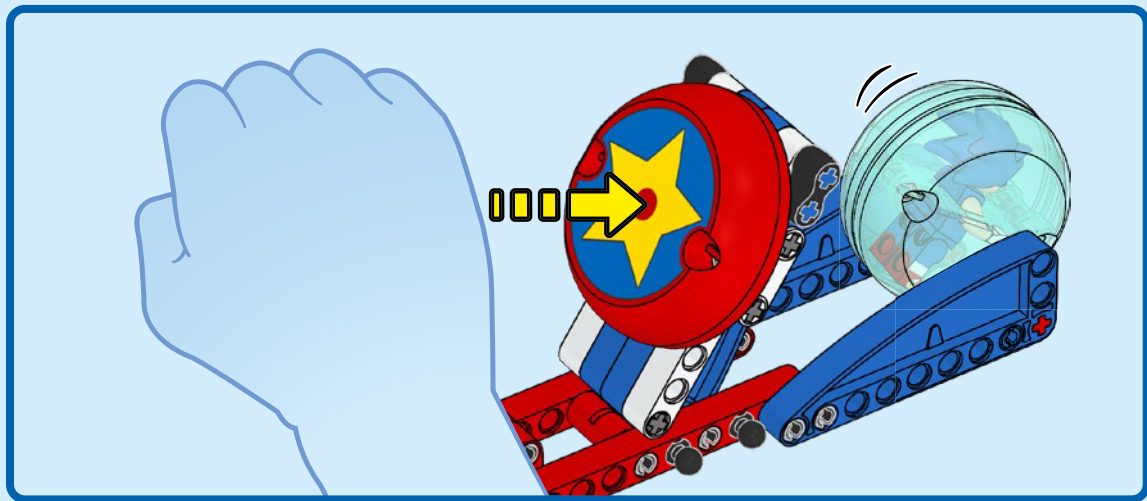

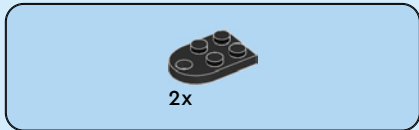
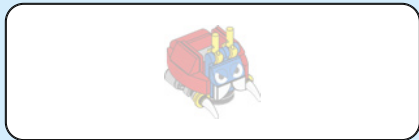

1

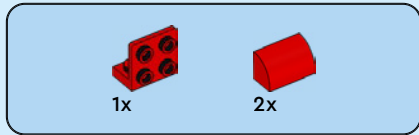
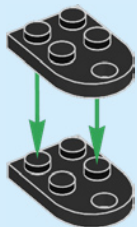

2

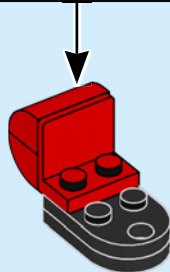
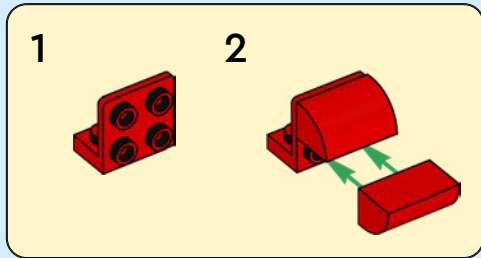

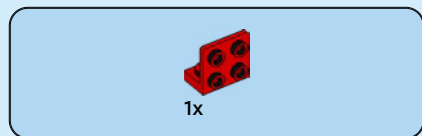

3

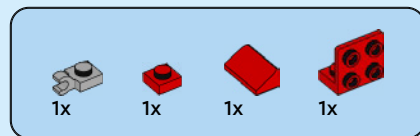
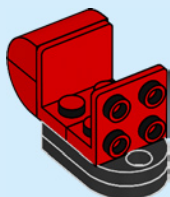

4

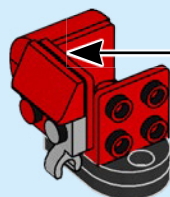
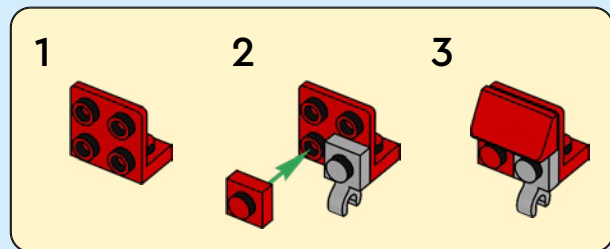

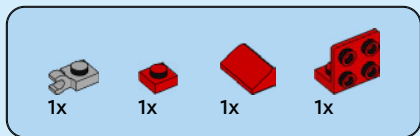

5

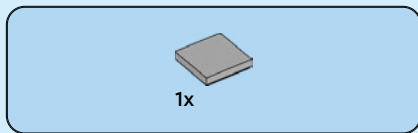
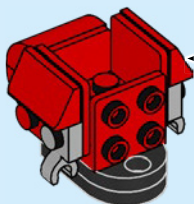
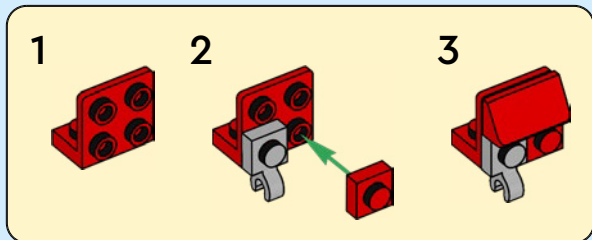

6

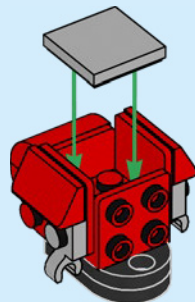

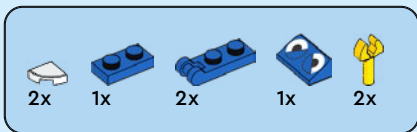

7

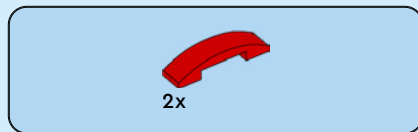
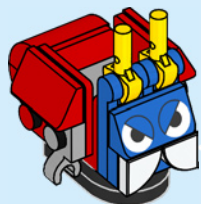
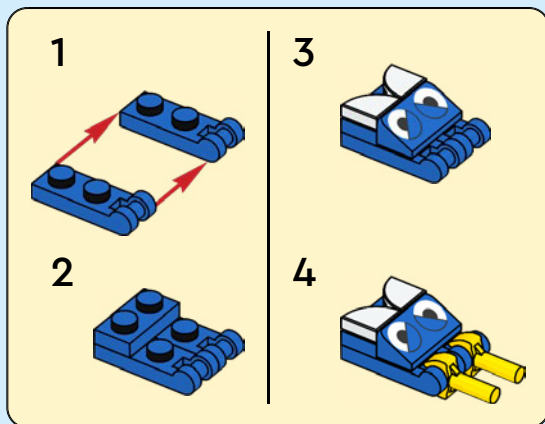

8

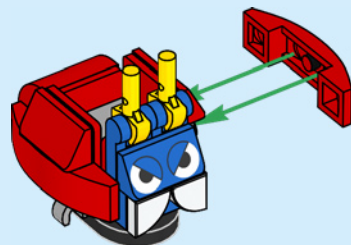



2x



2x



2x



2x

9

1

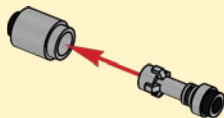

2

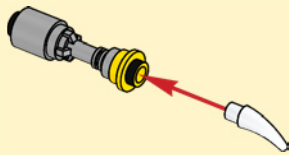

2x

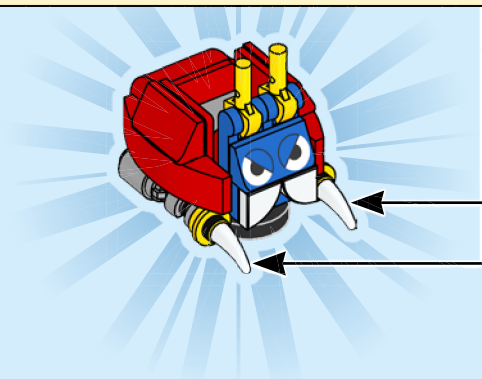

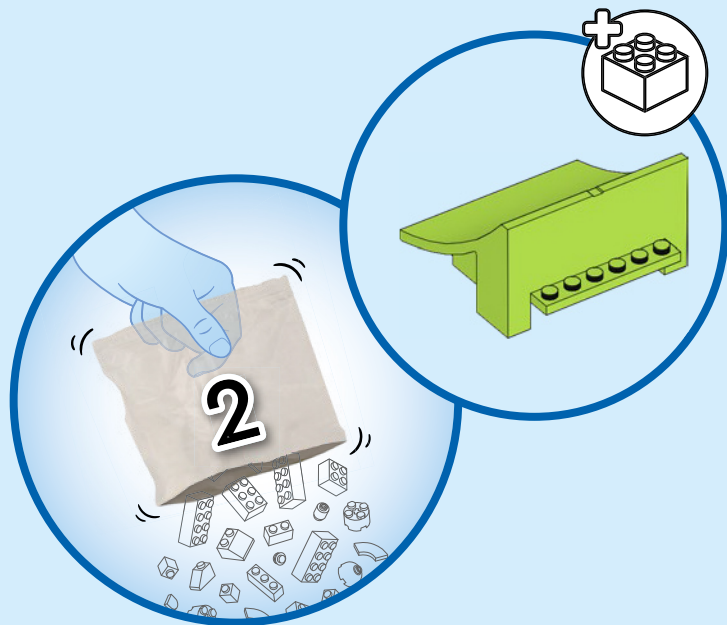

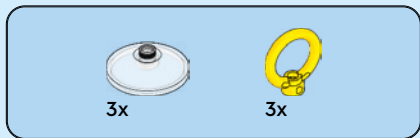

3x

3x



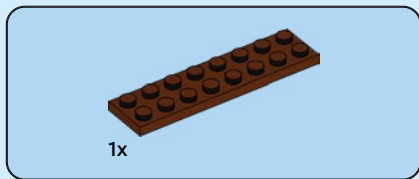
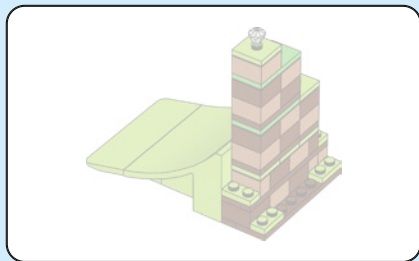

1

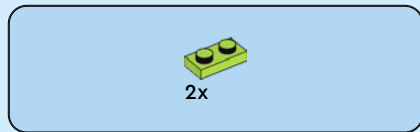
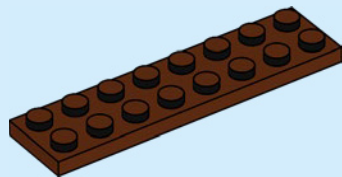

2

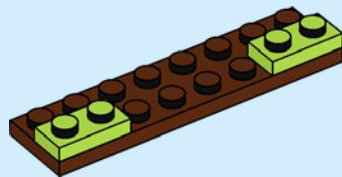



1x



1x

3

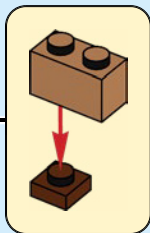
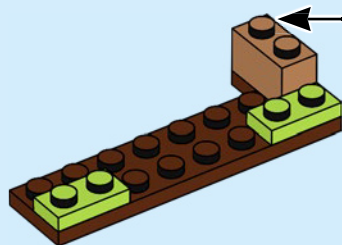

1x



1x



1x

4

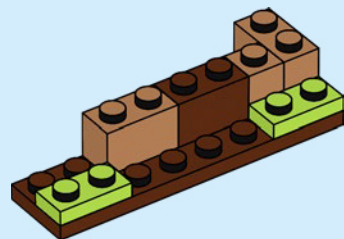



5

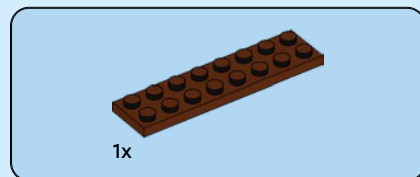
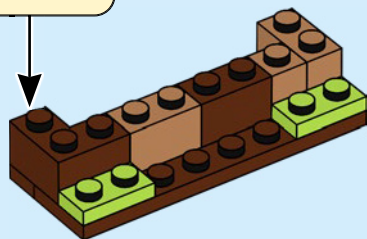
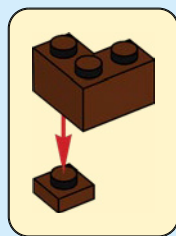

6

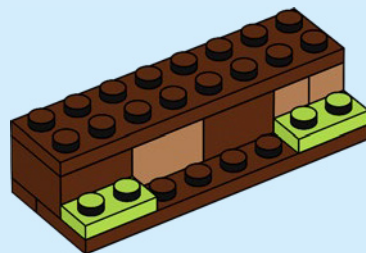



2x

7

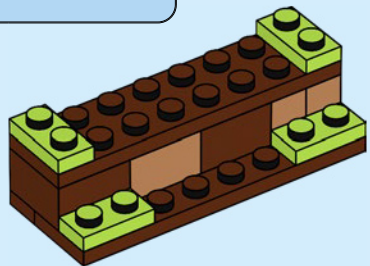

1x



1x



1x



1x

8

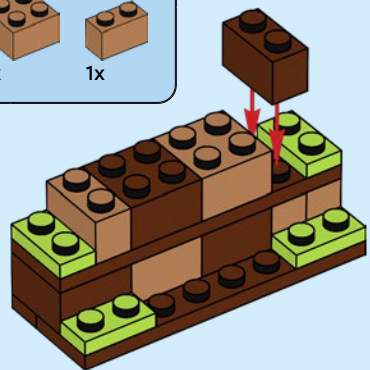

3x

9

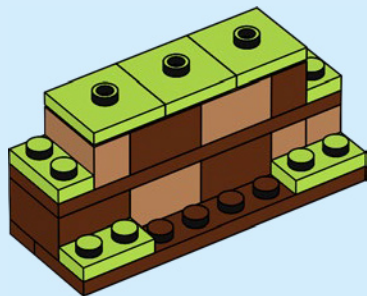

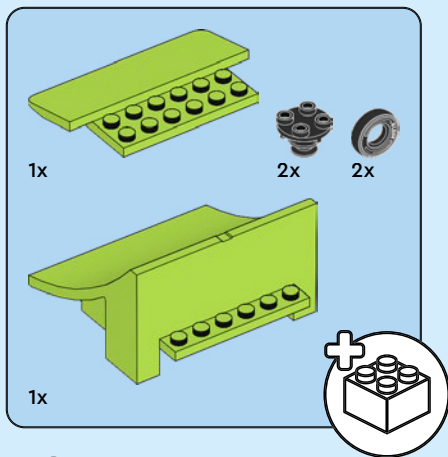

10

1

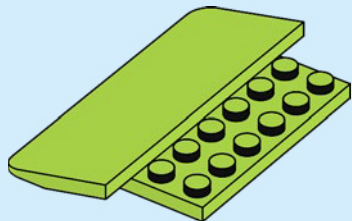

2

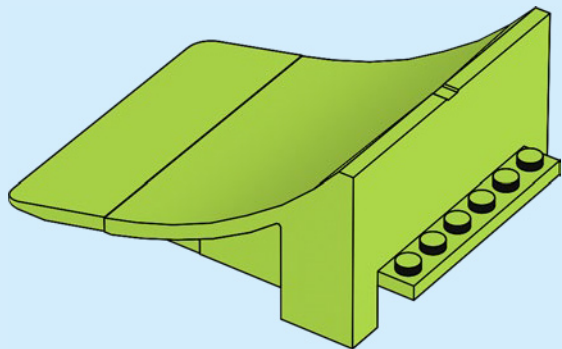



3

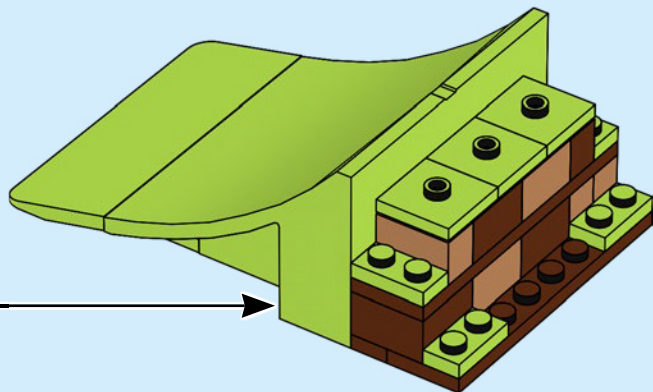
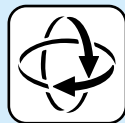
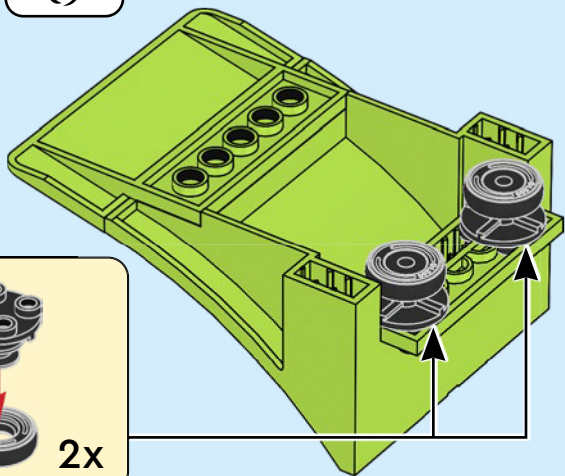
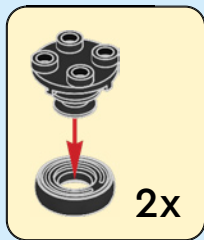

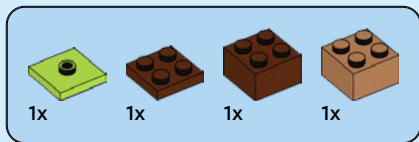

11

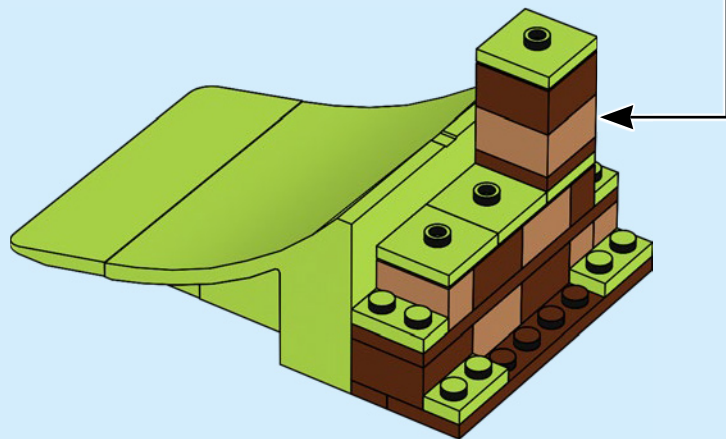
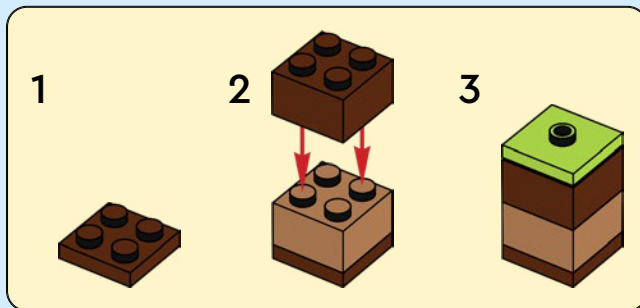



2x



4x



4x



2x



2x

12

1

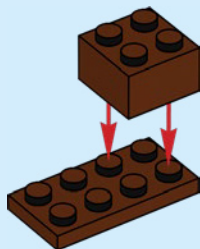

2

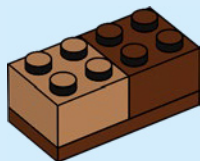

3

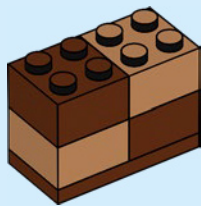

4

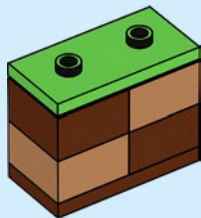

2x

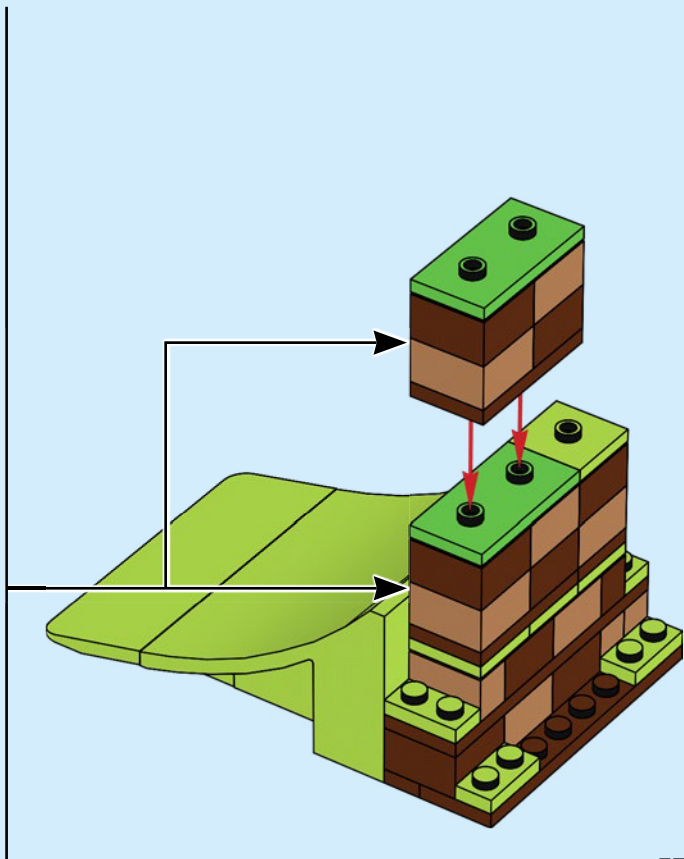

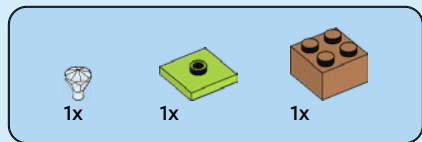

13

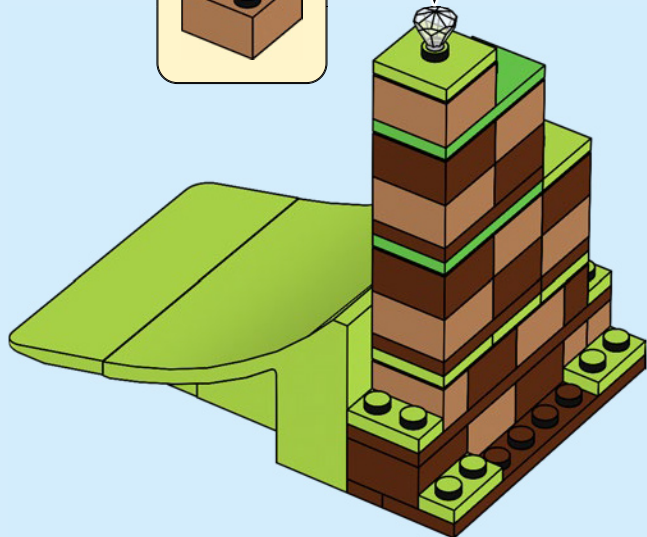
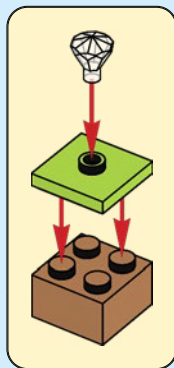

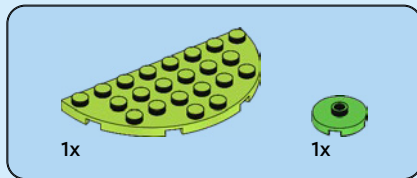
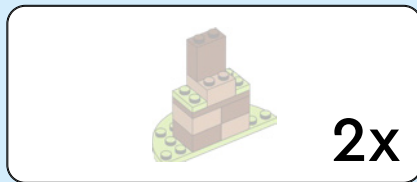
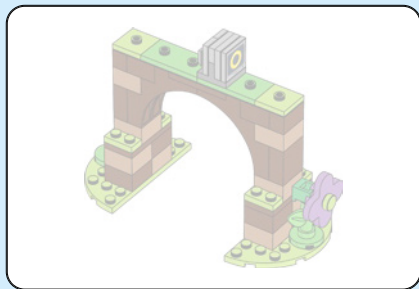

1

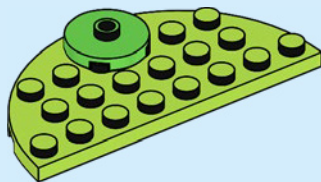



1x



1x

2

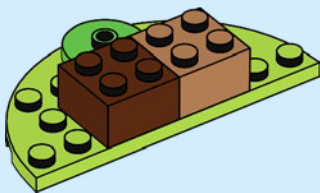

1x



1x

3

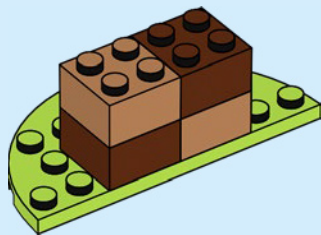

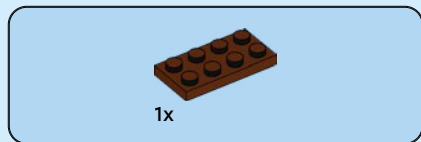

4

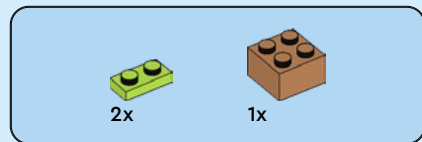
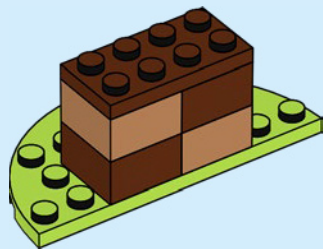

5

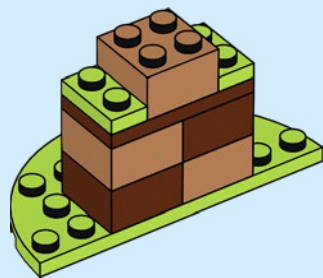



1x

6

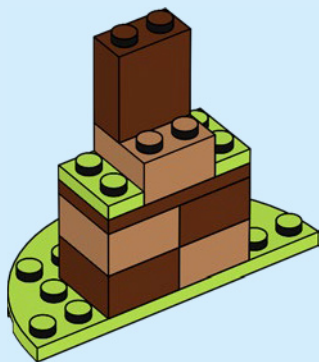

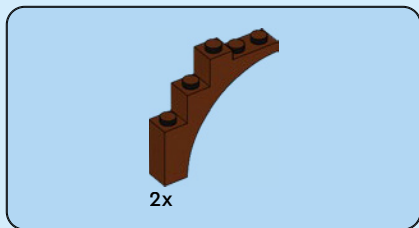

7

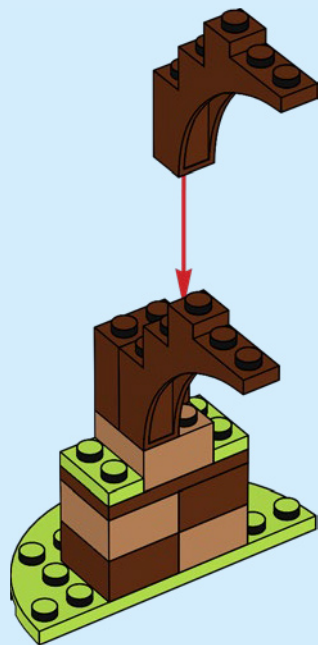

2x





1x

8

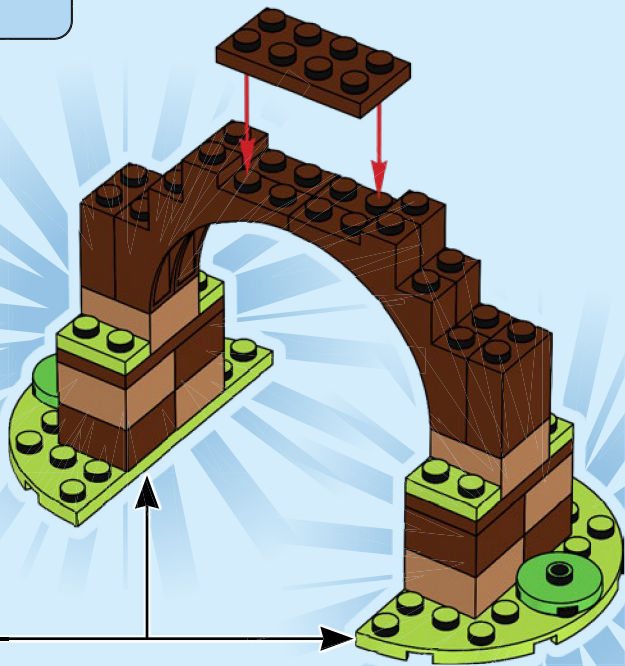



2x

9

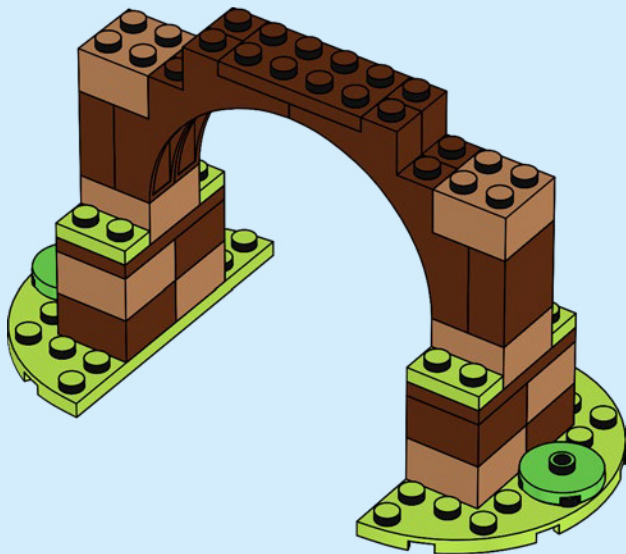

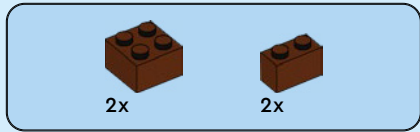

10

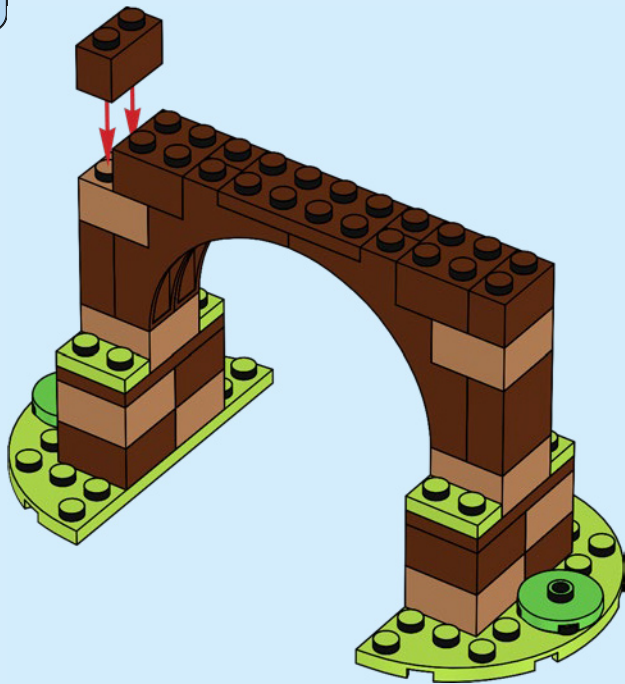



2x



2x

11

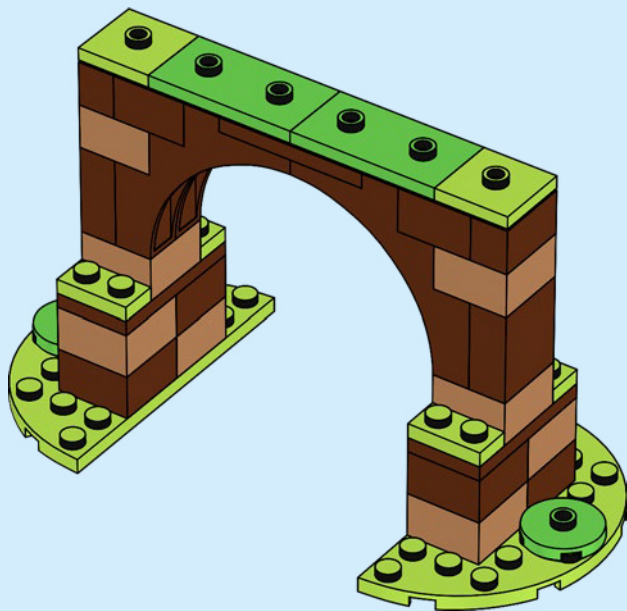

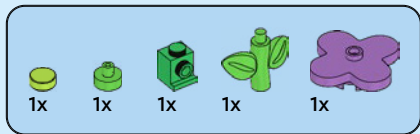

12

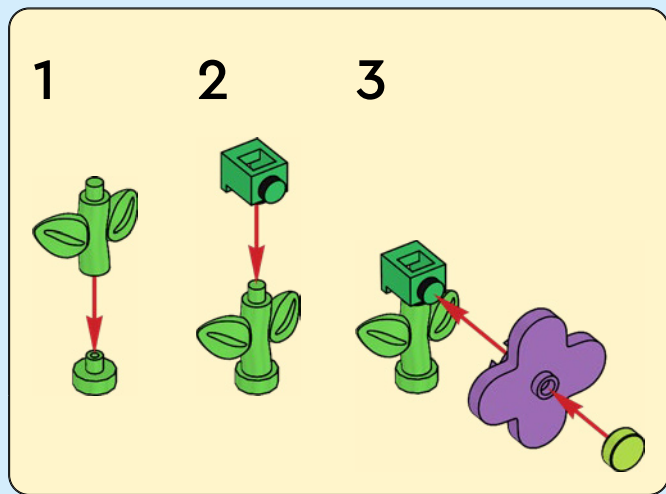
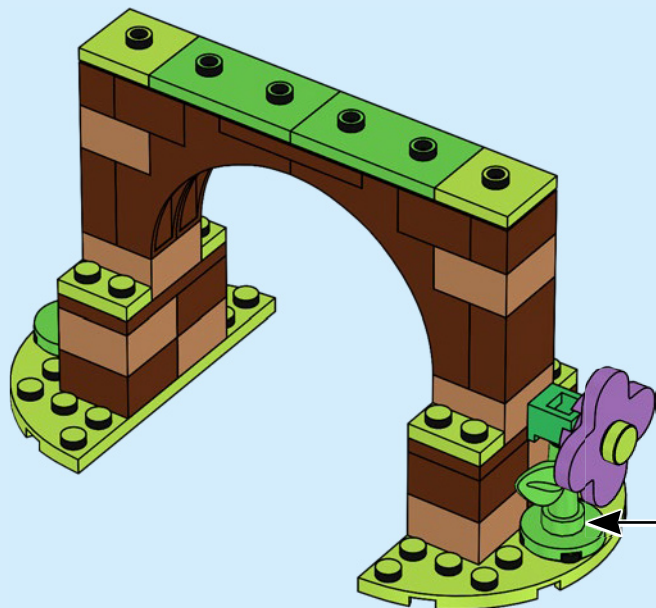

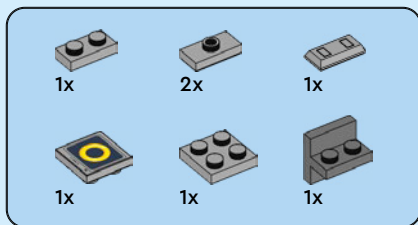

13

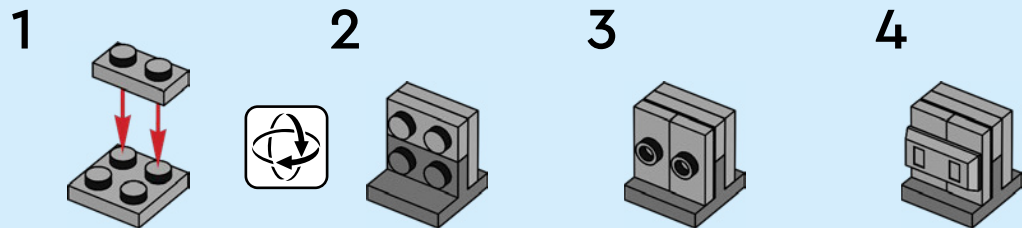

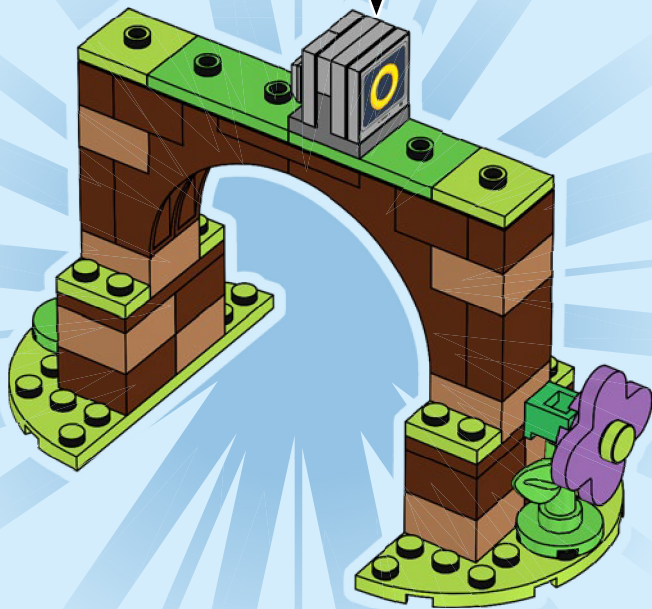

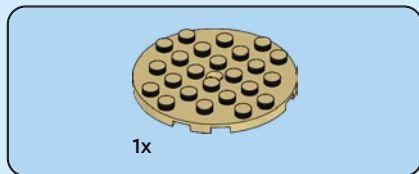
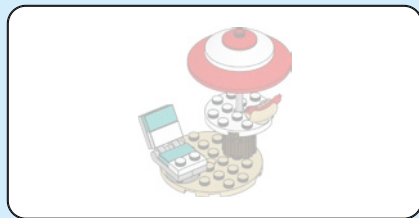

1

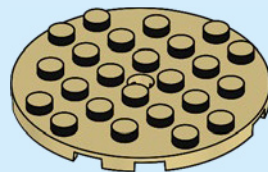

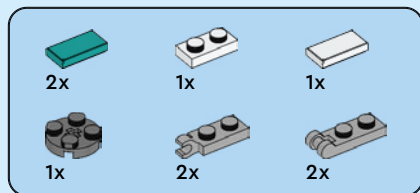

2

1



2

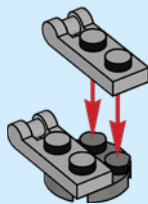

3



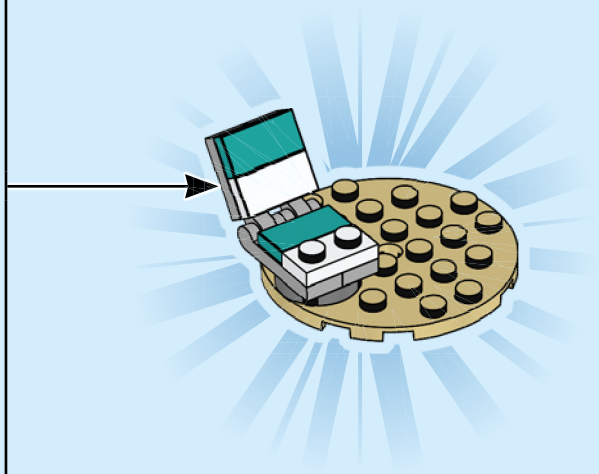
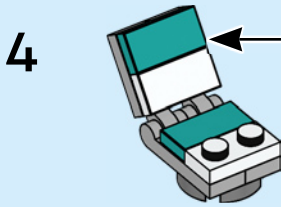
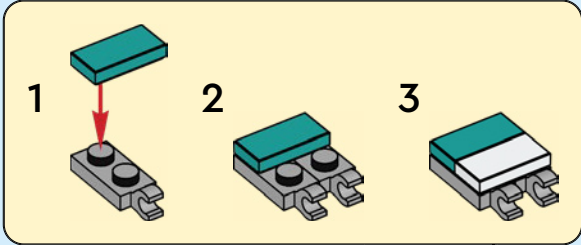

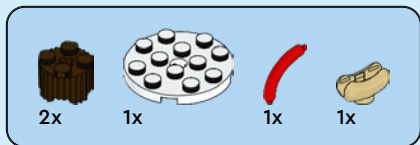

3

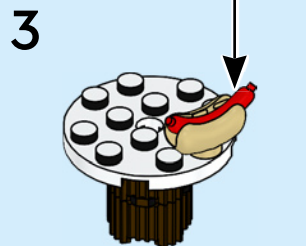
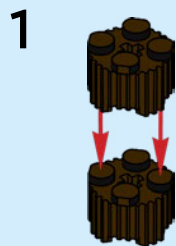

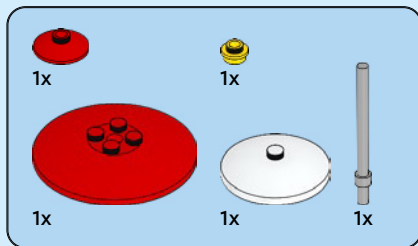
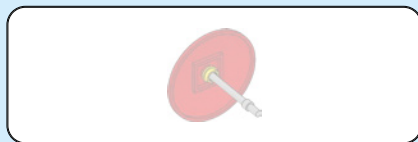
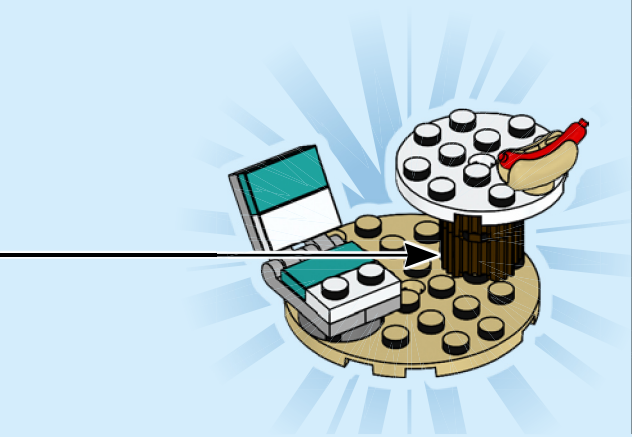

4

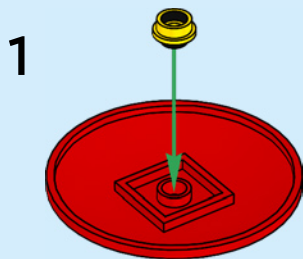

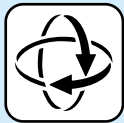

2

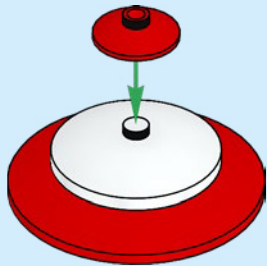

3

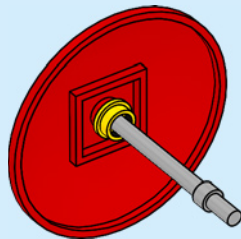

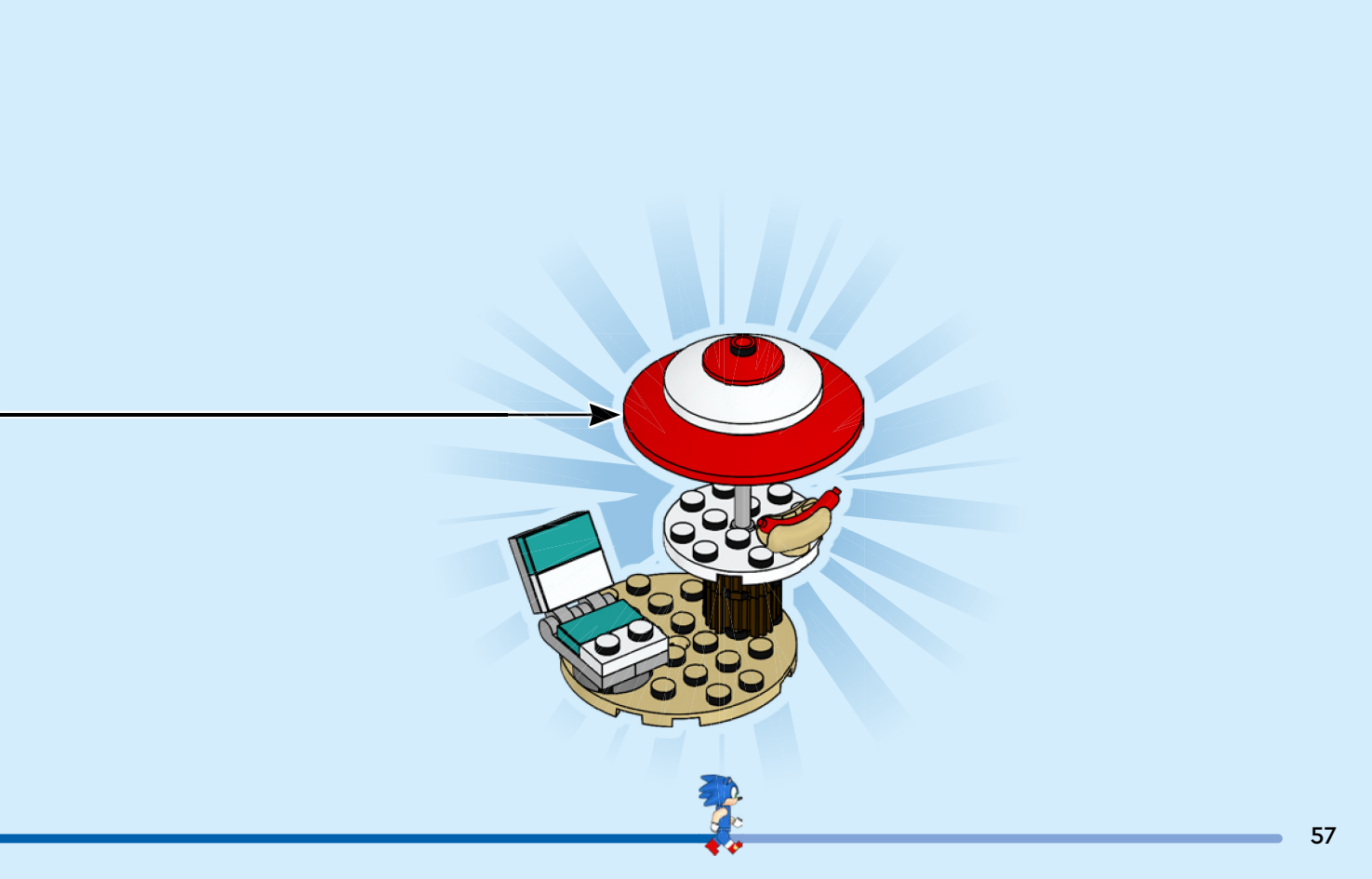

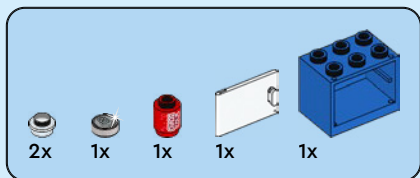

1

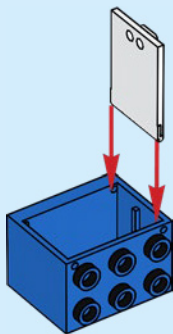

2

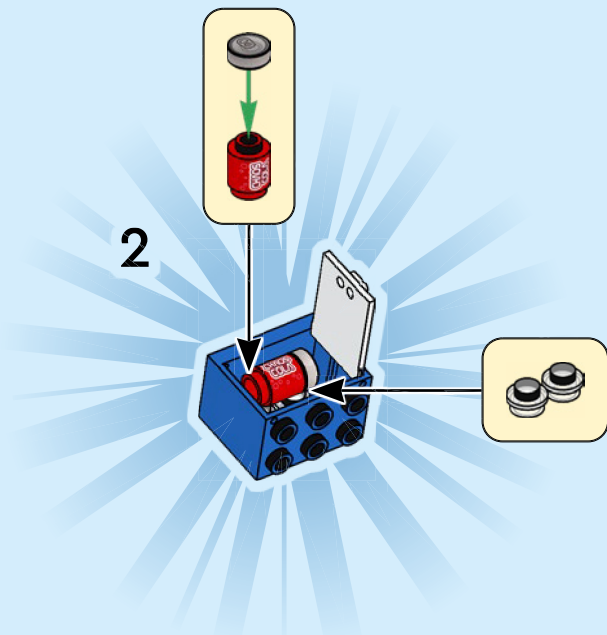

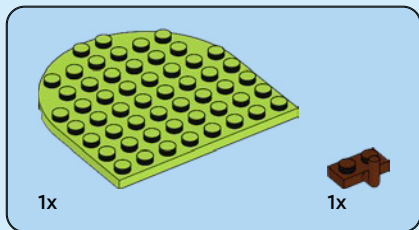
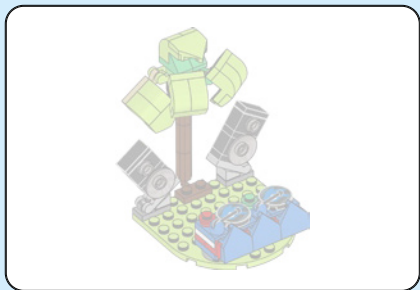

1

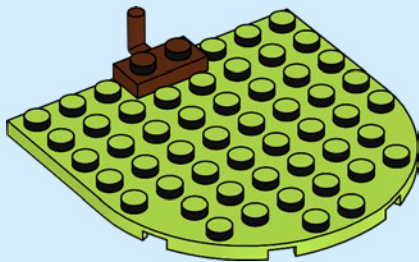



2x



2x

2

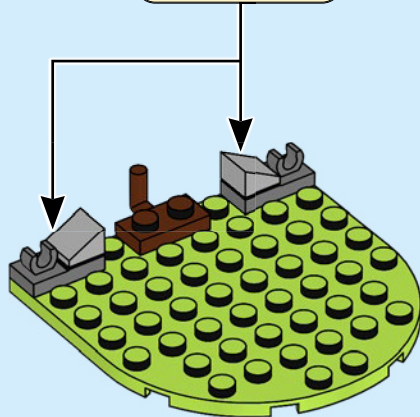
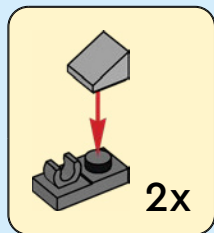

2x

3

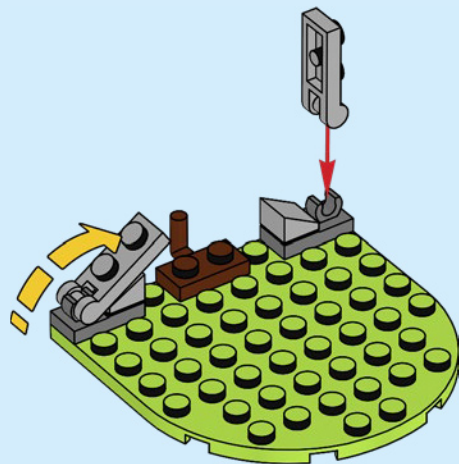

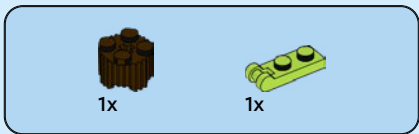

4

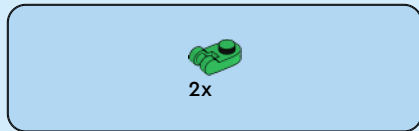
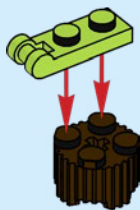

5





1x

6



2x

7

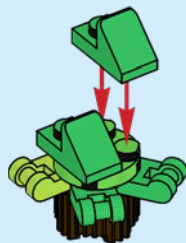



2x

8

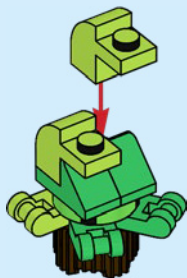

1x

9

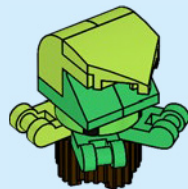

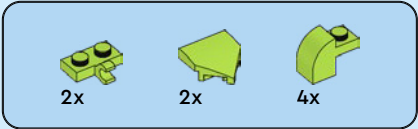

10

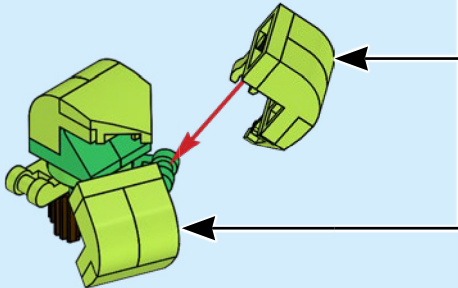
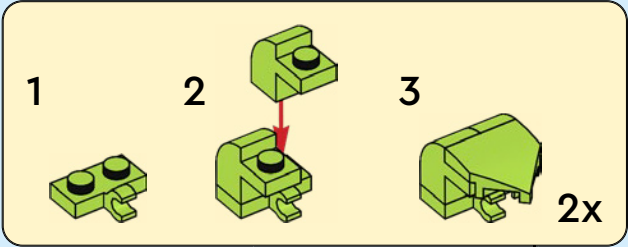

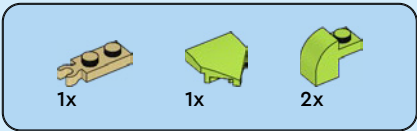

11

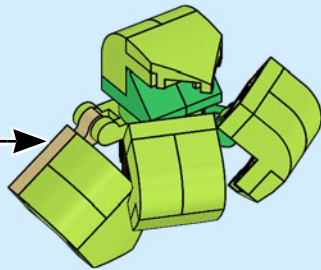
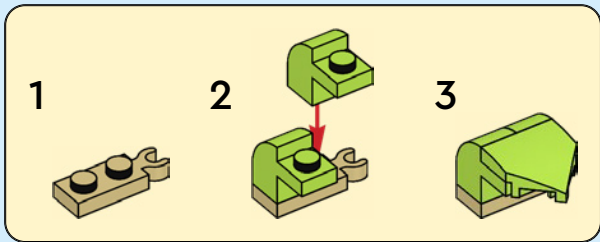



12

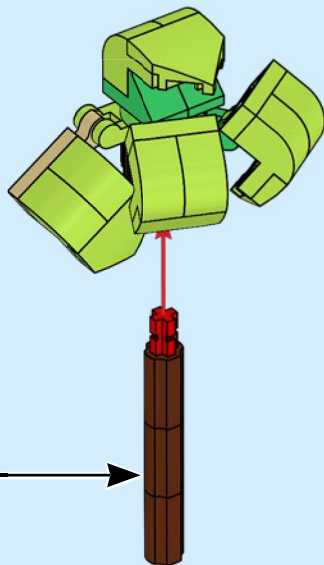
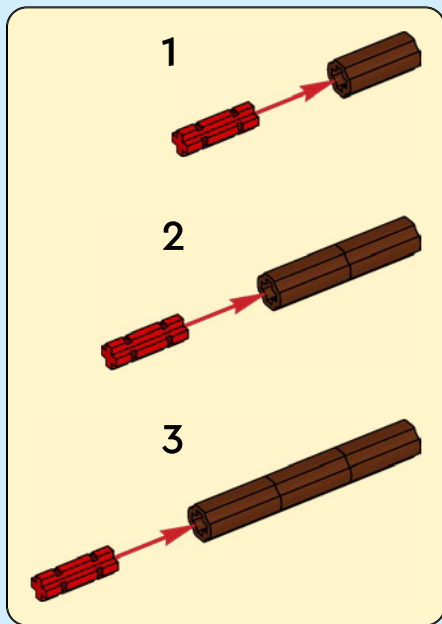

13

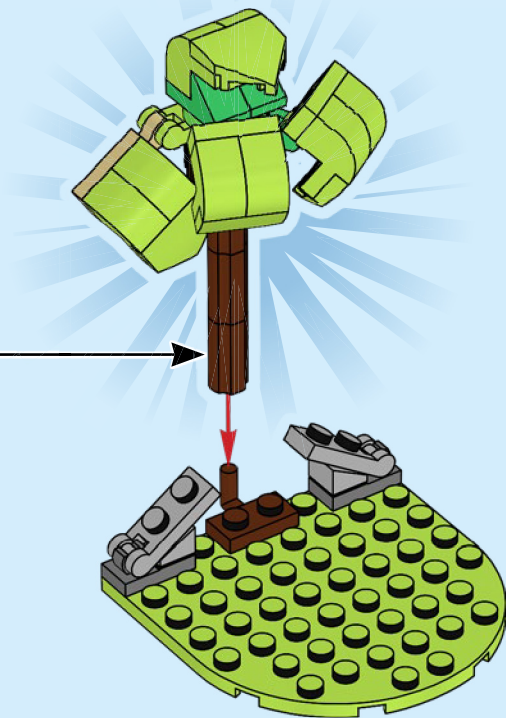



2x



2x



2x



4x



2x



4x

14

1

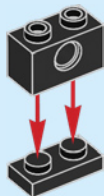

2

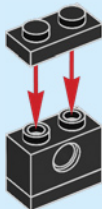

3



4

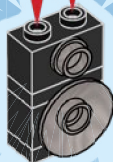

2x

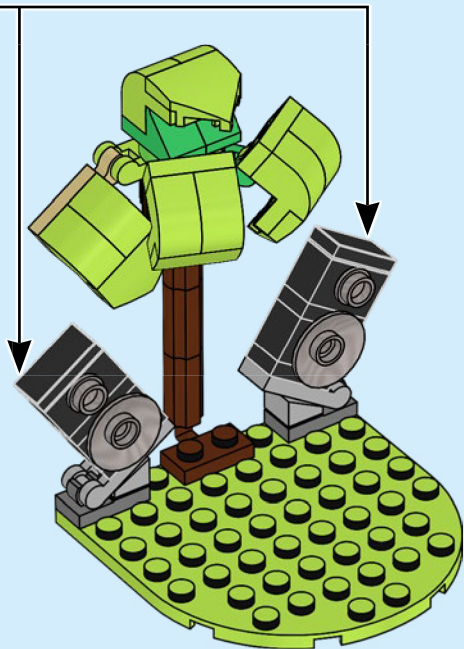

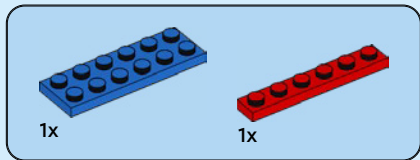

15

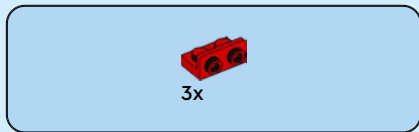
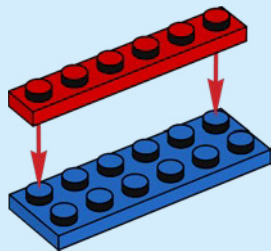

16

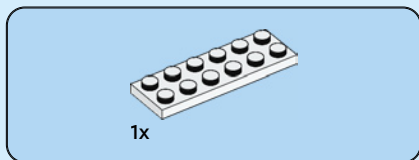
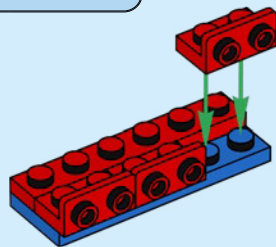

17

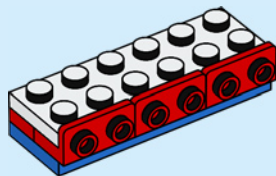

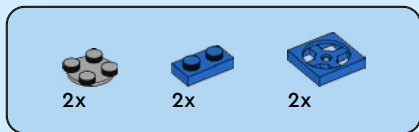

18

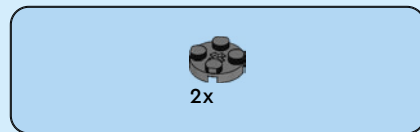
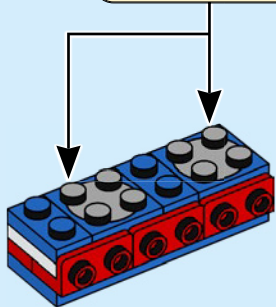
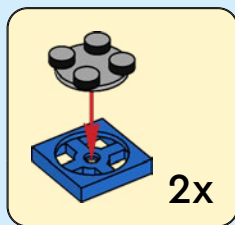

19

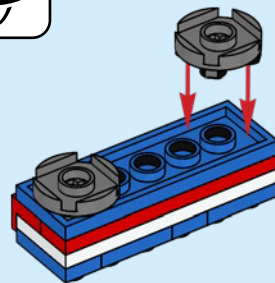
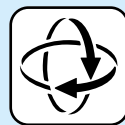



2x

20

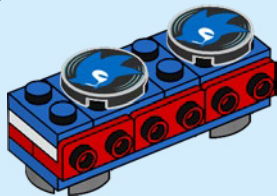
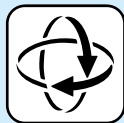

2x



1x



1x

21

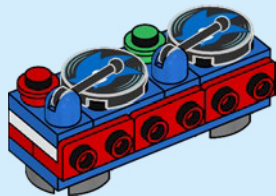

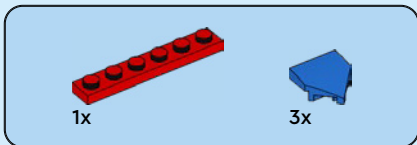

22

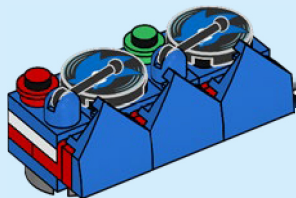
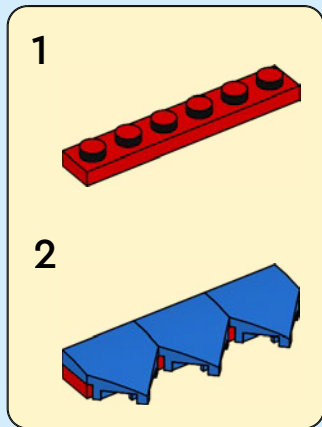

23

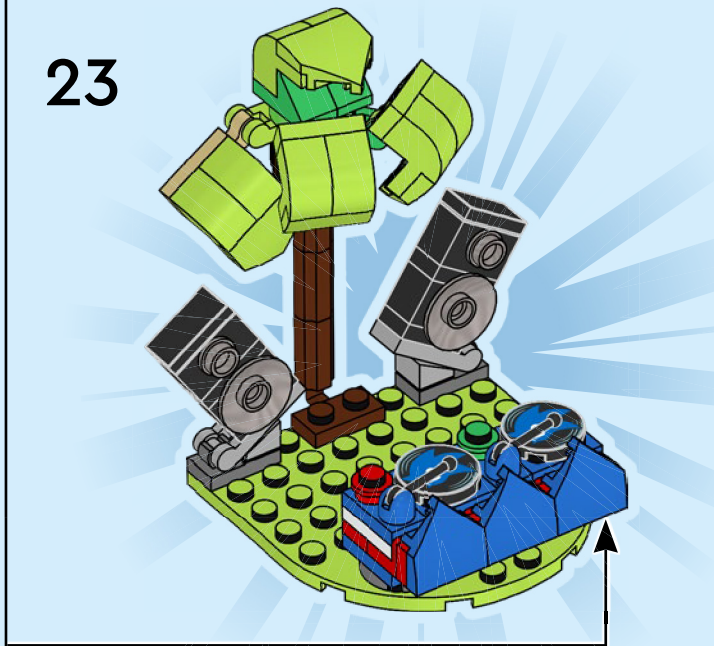







SONIC™

THE HEDGEHOG



Combine sets to
expand your play!



76990



Combine sets to expand your play!
 Kombiniere Sets für noch mehr Spielspaß!
 Combine les niveaux pour étendre ton expérience de jeu !
 Combina i set per espandere il tuo gioco!
 ¡Combina sets para jugar mucho más!
 Combina sets para expandir os teus momentos de diversão!
 组合系列套装, 增强玩乐体验!
 Łącz zestawy i baw się jeszcze lepiej!
 Kombinujte stavebnice a rozšiřujte svou hru!
 Kombinujte stavebnice a rozšiřujte herné možnosti!
 A készletek egyesítésével bővítsd a játékot!
 Combina seturi pentru a-ți extinde joaca!
 Комбинируйте комплекты за по-интригуваща игра!
 Arvieno komplektus, lai pilnveidotu savas rotaļas!
 Kombineeri komplekte, et mängu laiendada!
 Derinkite rinkinius ir išplėskite žaidimą!



2x
6270106

2x
6172366

1x
302301

1x
306901

1x
4261470

2x
6276981

1x
396001

1x
4515347

1x
379501

2x
6001831

78

1x
6147214



1x
6372047

1x
6093862

1x
614121

1x
6452585

2x
302421

1x
6144805

2x
4651524

5x
4142865

1x
4585146

2x
6381444

1x
6173126

2x
6252037

3x
6089698



4x
6001806

2x
4633914

2x
366621

1x
6156534

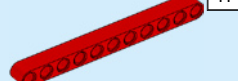
1x
6443200

2x
4562805

2x
4296152

1x
6443151

8x
4206482

1x
6372164

3x
6378794

3x
302323



2x
368023

2x
6073890

1x
6452519



1x
6313992

1x
379523

4x
6441687

3x
6168644

2x
6439051

3x
6441692

2x
4516843

4x
6344752

2x
6443153

16x
6279875

2x
6252373

4x
4198367

4x
302326

4x
370026

2x
306926

2x
317626

1x
4569058

1x
6400649

1x
4187334

2x
6253140

2x
6226931

1x
6138624



2x
6380676

9

11

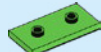

1x
6400112



4x
6293826



2x
6240030



1x
6247798



3x
6244730

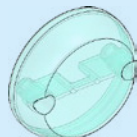

2x
6455182



2x
6213779



1x
6284583



8x
4164037



2x
6334046



7x
6056291



1x
6133859



2x
6133225

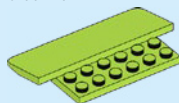

1x
6435725

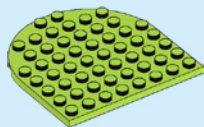

1x
6252480

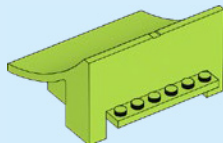

1x
6435726



8x
6411328



4x
6442920



2x
4221744



3x
4531751



2x
6172808



4x
4211149



1x
6261359



12x
4211210



1x
4211200



1x
4216695



5x
4211186



4x
6044725



2x
4211211



1x
6170418



2x
4539481



2x
4211412



2x
4521921



2x
6335378



2x
4540203



1x
4211398



2x
6066097



1x
6134378



2x
6319336



1x
4211397



1x
6443152



4x
4515369



1x
4211413



1x
6443154



3x
4211042



2x
6344754



4x
6015356



1x
6083620



1x
6250018



1x
6057986



3x
4569382



15x
6058085



1x
6322904



1x
6443156



3x
6109329



2x
6051507



2x
6277260



1x
6442916



[LEGO.com/service](https://www.lego.com/service)

YOU COULD
WIN



Scan this QR code or go to
LEGO.COM/PRODUCTFEEDBACK and give
us your short feedback about this LEGO® set
for a chance to win a cool LEGO prize.

Terms and Conditions apply*

EN: YOU COULD WIN. Terms and Conditions apply* **DE: Du könntest GEWINNEN.** Es gelten die Teilnahmebedingungen* **FR: Tu pourrais GAGNER.** Des conditions s'appliquent* **IT: Potresti VINCERE tu.** Termini e condizioni sono applicabili* **ES: Puedes GANAR.** Aplican términos y condiciones* **PT: Poderá GANHAR.** Aplicam-se termos e condições* **ZH: 轻松获奖. 条款和条件适用*** **PL: Szansa na WYGRANĄ.** Obowiązują warunki korzystania* **CS: Máte šanci VYHRÁT.** Platí všeobecné smluvní podmínky* **SK: Máte šancu VYHRÁŤ.** Platia všeobecné zmluvné podmienky* **HU: TE IS NYERHETSZ.** Felhasználási feltételek érvényesek* **RO: Ai putea CÂȘTIGA.** Se aplică termeni și condiții* **BG: Можете да СПЕЧЕЛИТЕ.** Има определени правила и условия* **LV: Tu vari LAIMĒT.** Ir spēkā noteikumi un nosacījumi.* **ET: Sul on võimalus VÕITA.** Kehtivad tingimused* **LT: Jūs galite LAIMĖTI.** Taikomos sąlygos*

*[LEGO.com/productfeedback-terms](https://www.lego.com/productfeedback-terms)

LEGO and the LEGO logo are trademarks of the LEGO Group. ©2023 The LEGO Group.

©SEGA. All rights reserved. SEGA is registered in the U.S. Patent and Trademark Office. SEGA and SONIC THE HEDGEHOG are either registered trademarks or trademarks of SEGA CORPORATION.

6490632