

The image shows a LEGO Technic set, the Ice Slizer (set number 8501), in a dynamic, action-oriented pose. The model is constructed from tan and dark blue Technic parts, including gears, axles, and connectors. It is positioned as if it is falling or flying through a dark, blue, icy environment. The background is filled with jagged, crystalline ice structures and a misty atmosphere. The set number '8501' is printed in large, bold, black digits in the upper right corner. The title 'ICE SLIZER' is prominently displayed in the upper left, with 'ICE' in a smaller font inside a circular gear-like frame above the larger 'SLIZER' text. The overall aesthetic is cold and industrial, consistent with the 'Ice' theme of the set.

ICE  
SLIZER

8501

LEGO Technic

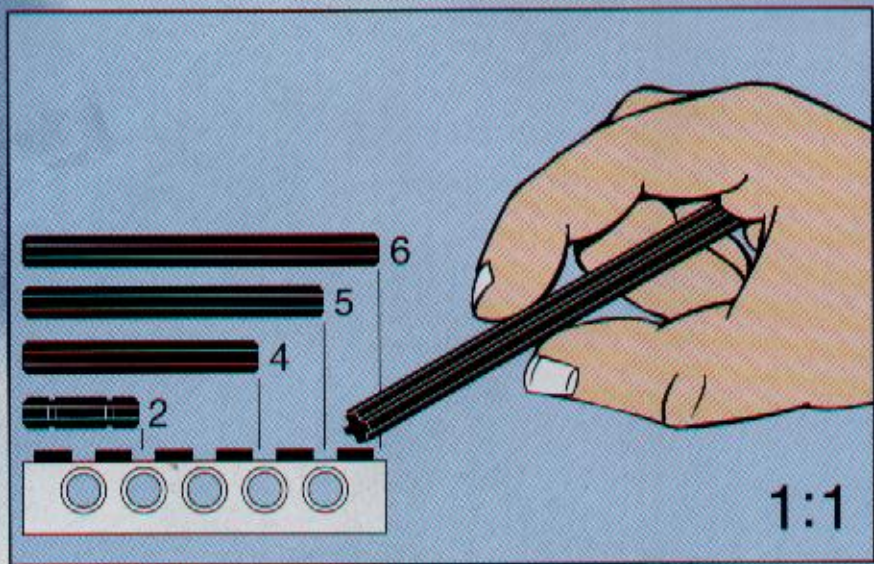



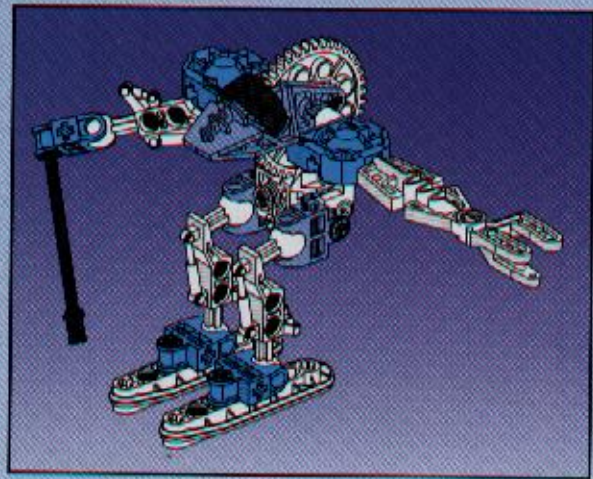

1





2

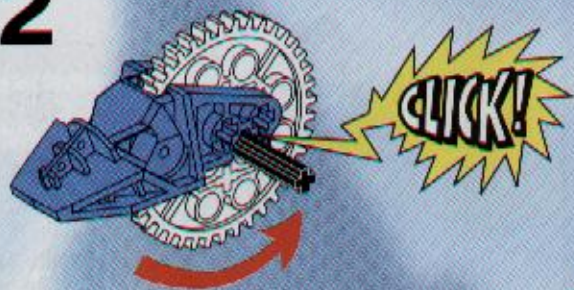

3

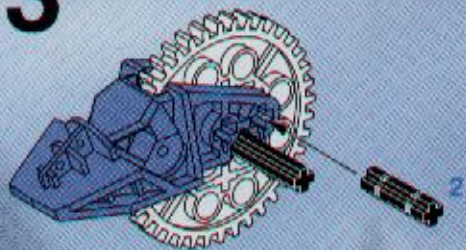



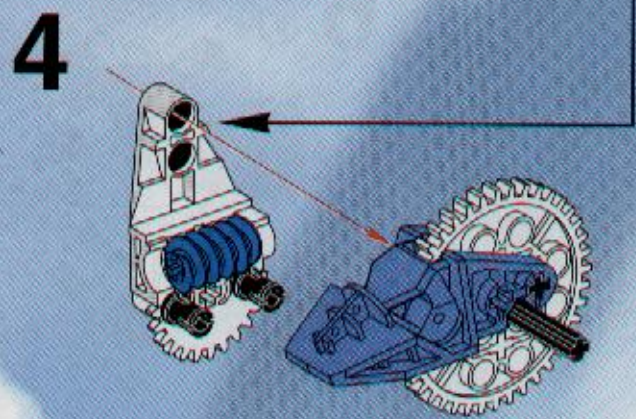
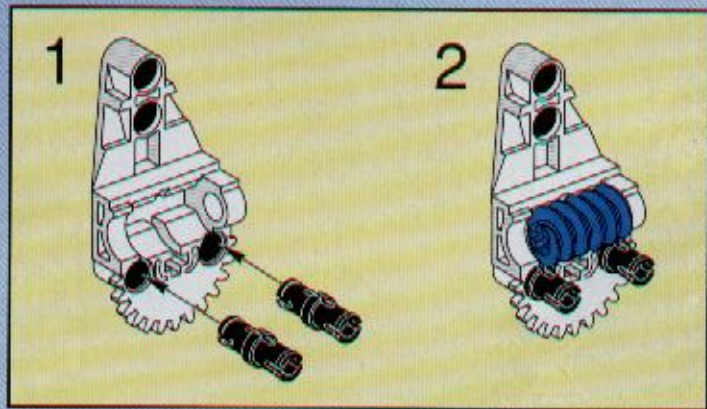



5

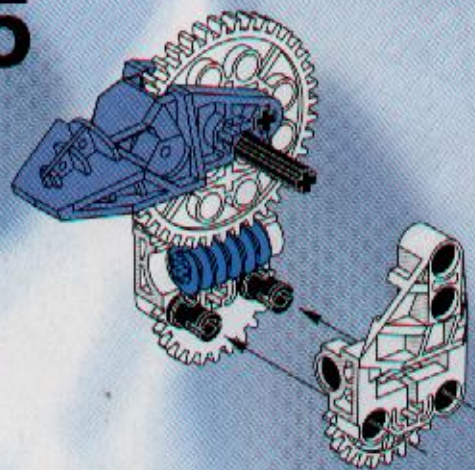

6

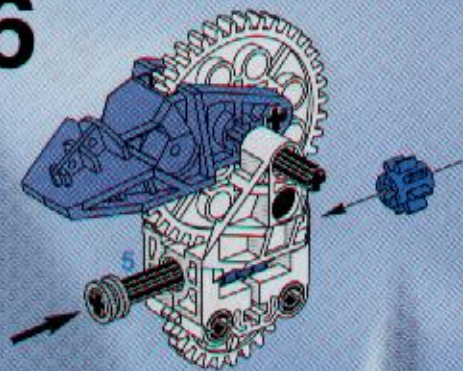



7

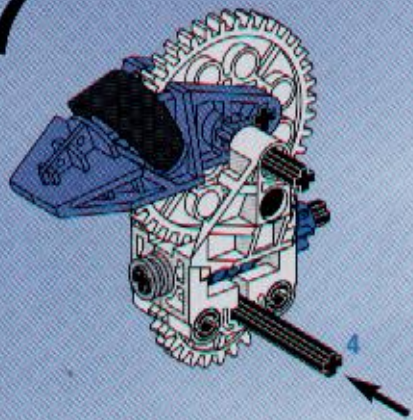

8

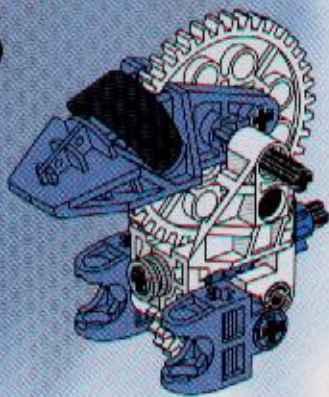



9

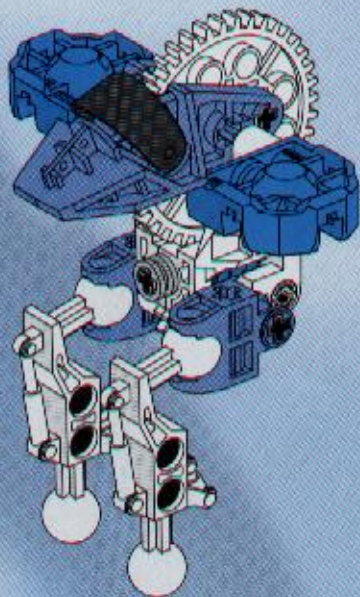







# 11

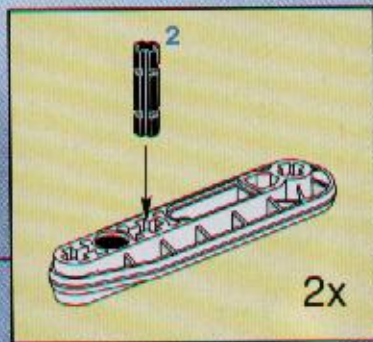
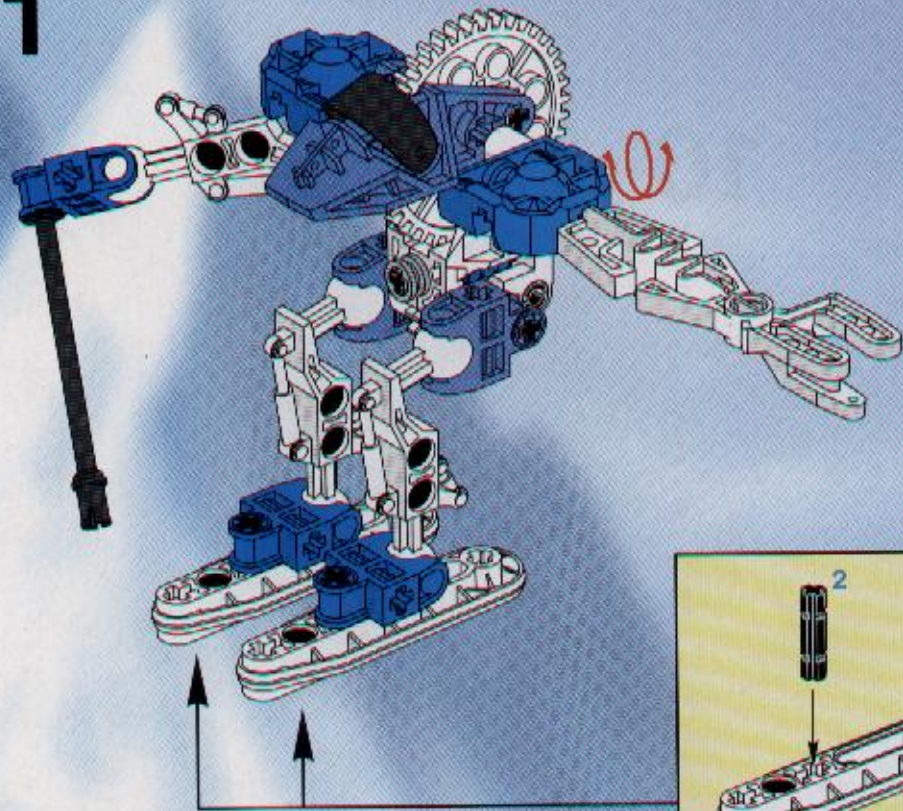











3

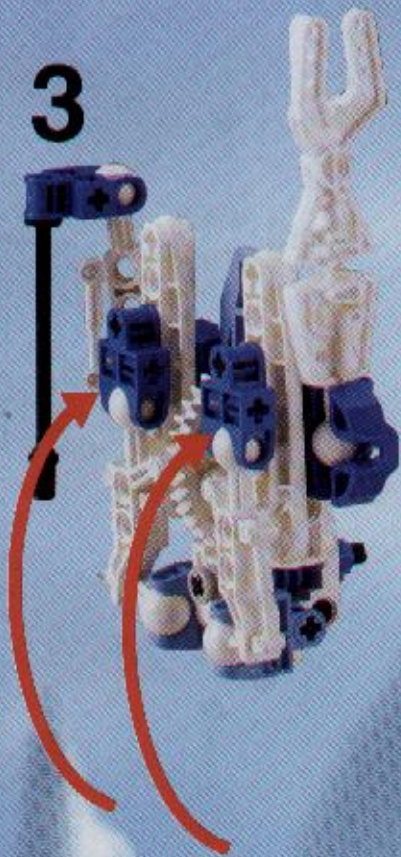

4





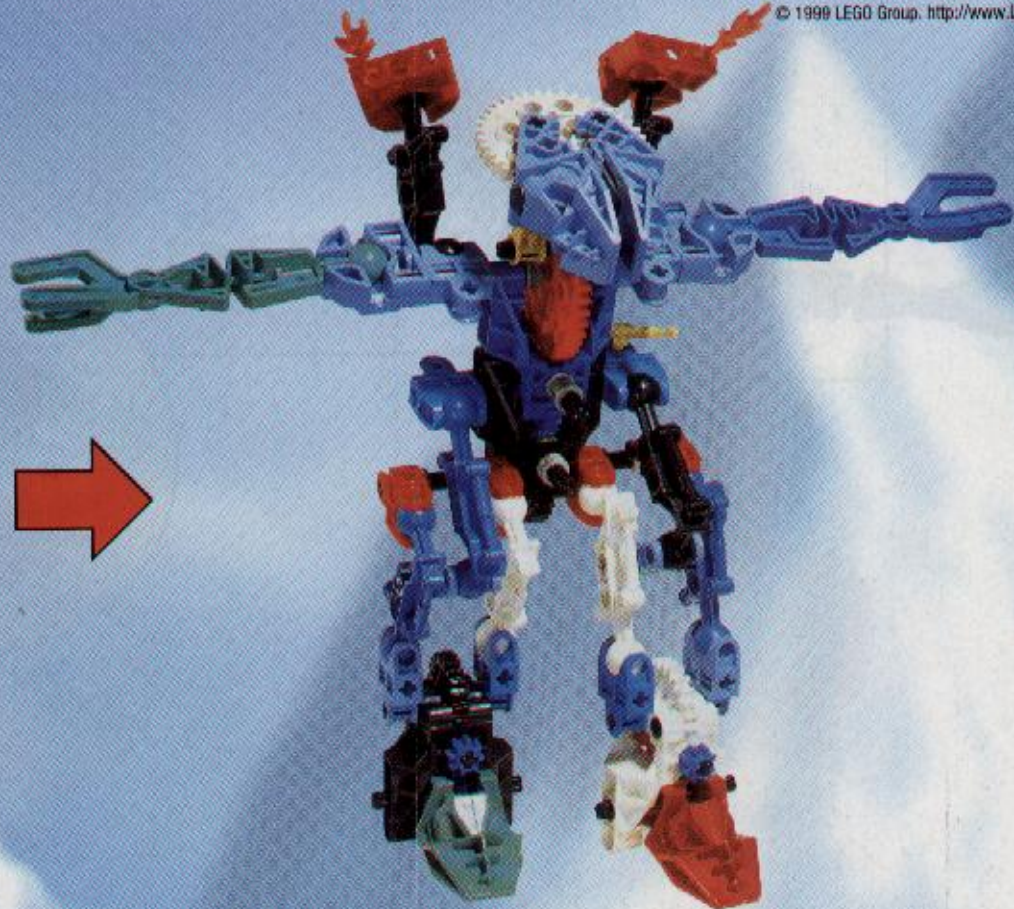

8500



8501



8502



8503



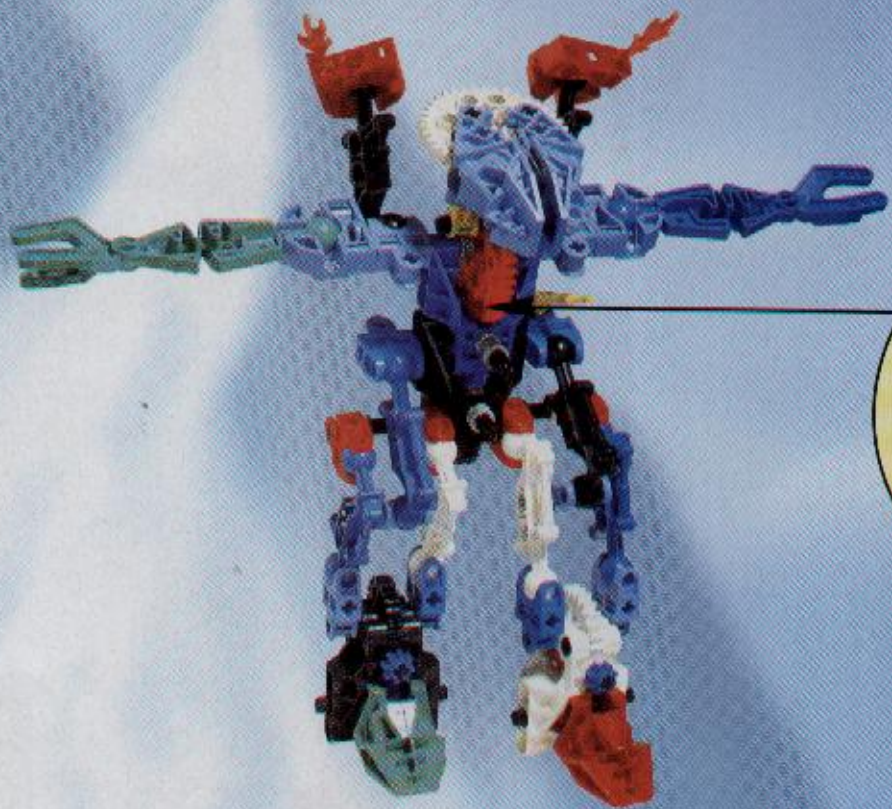







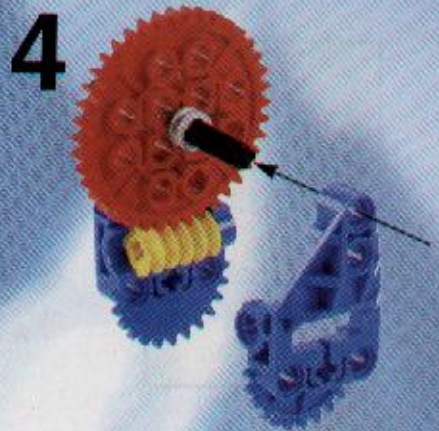



7



6



2x

8



9



10





11



12



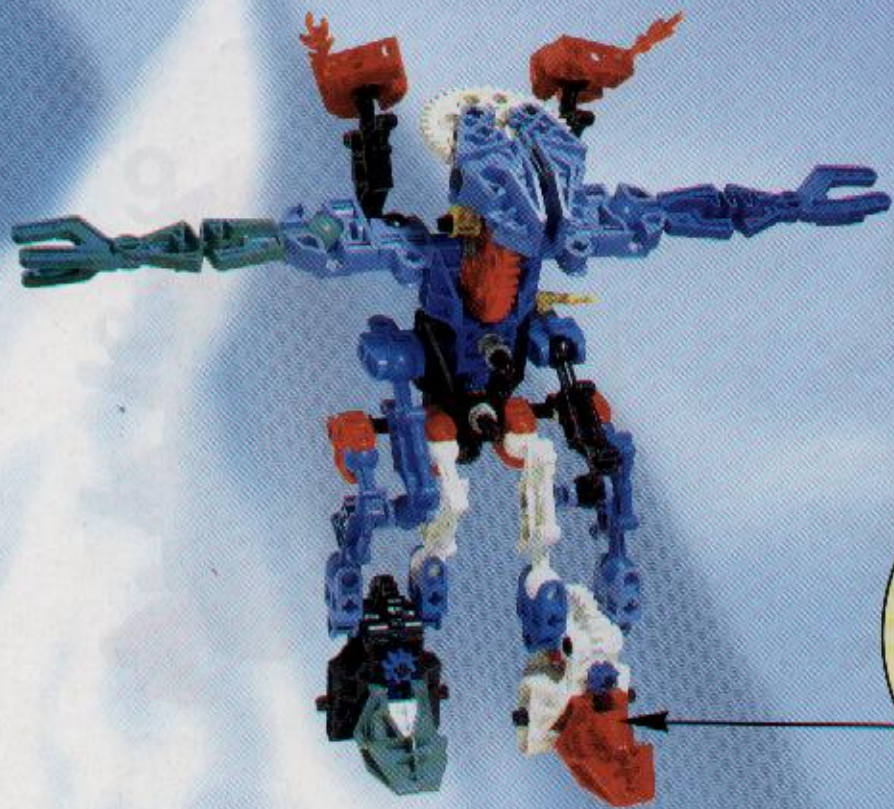



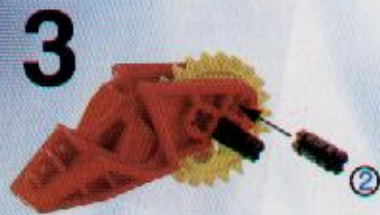

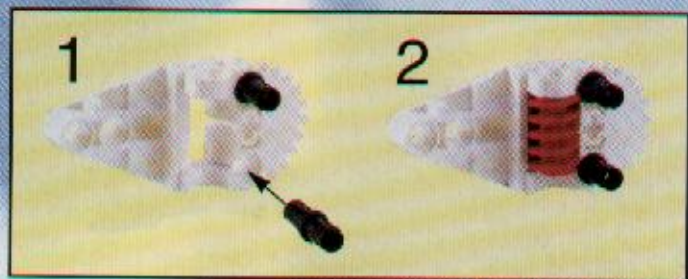



6

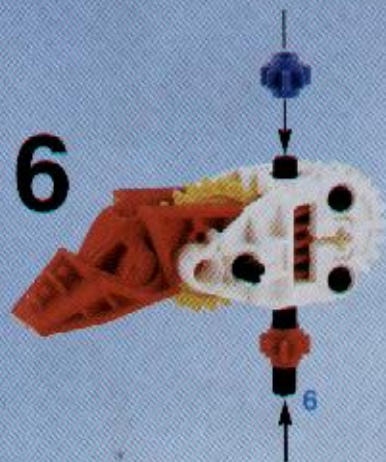

7

