



# STAR WARS™

7915



1

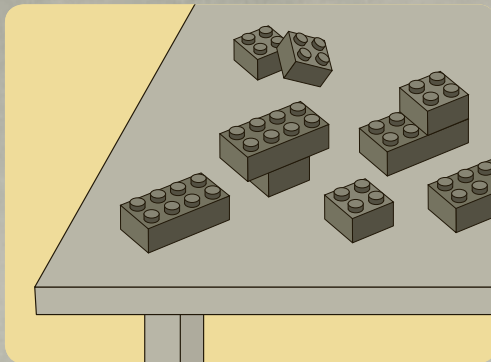
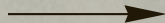
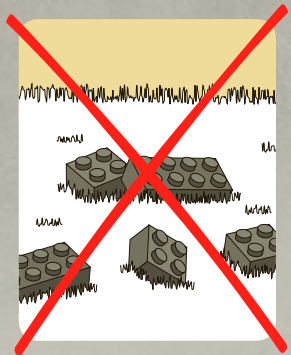

2

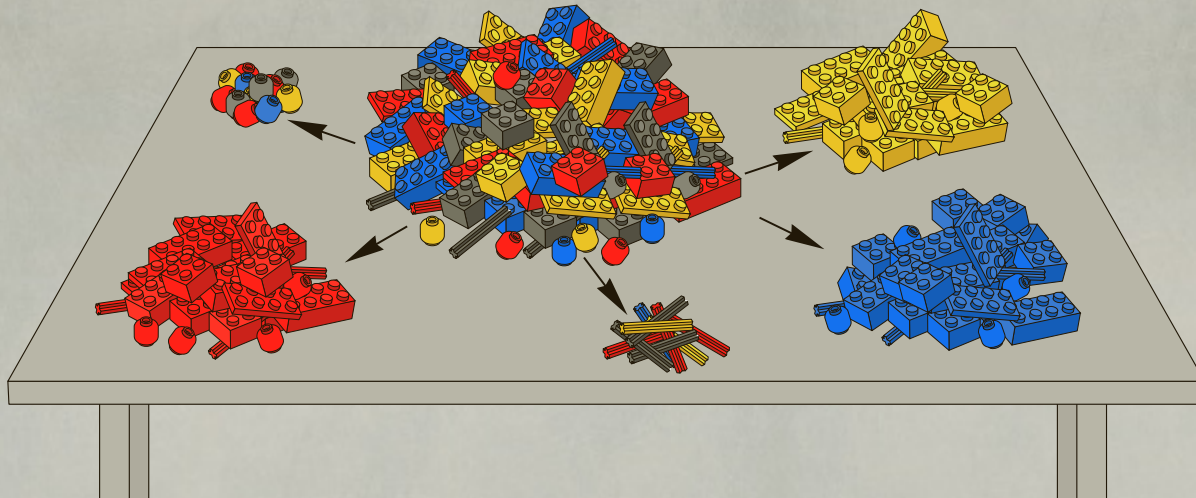

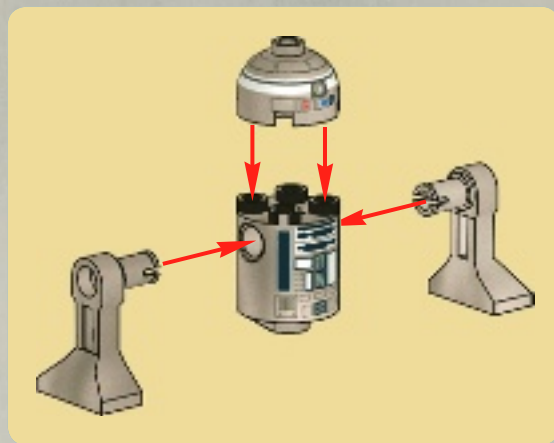
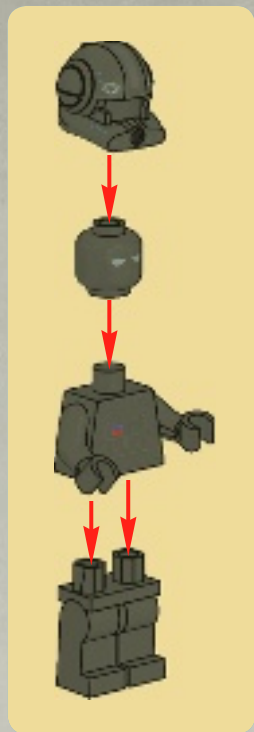



1x

1

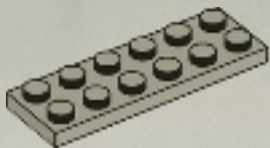

1x

2

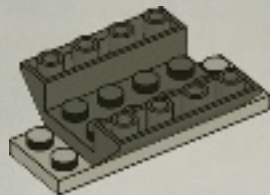



2x

3

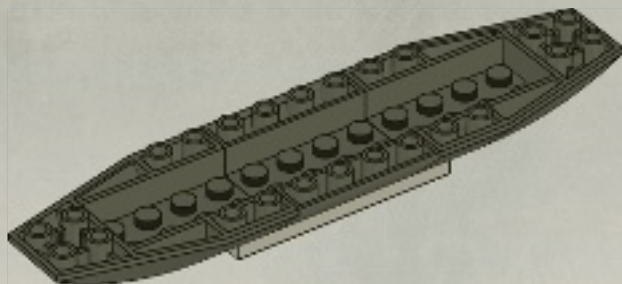



4

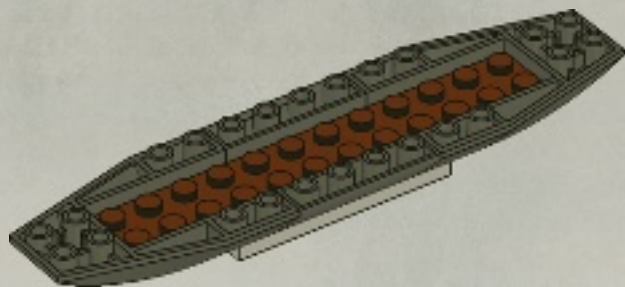





1x



1x

5

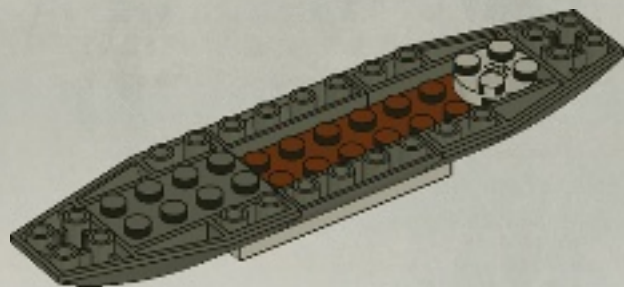



6

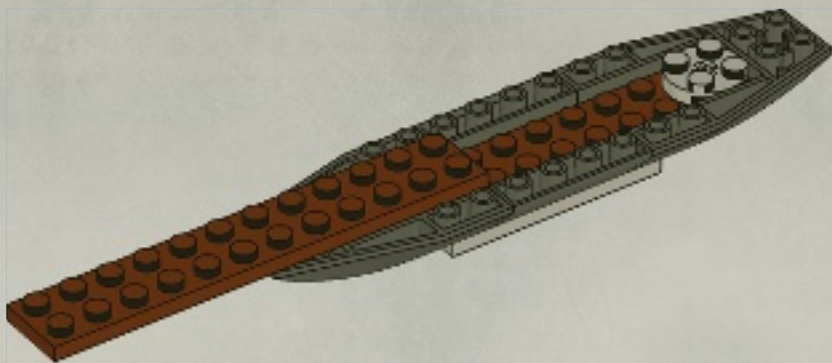

8





1x



1x

7

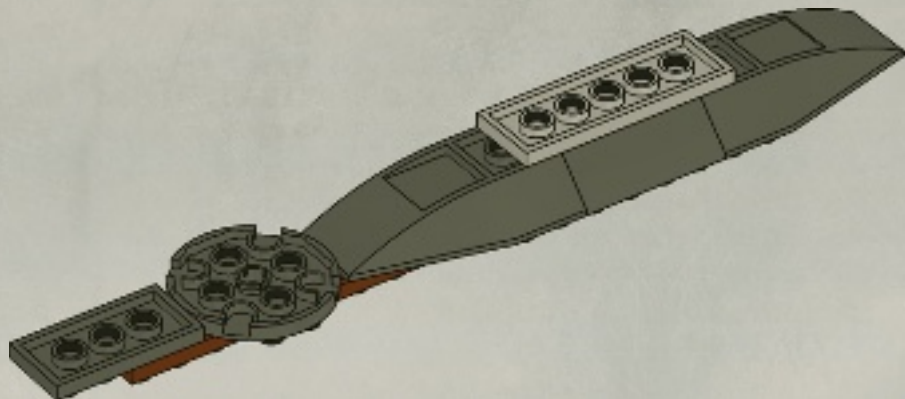



1x



1x

8

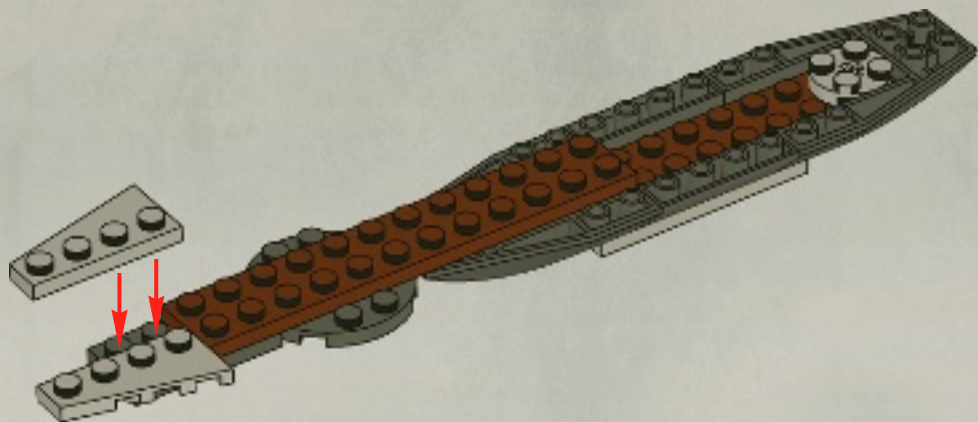



1x



1x

9

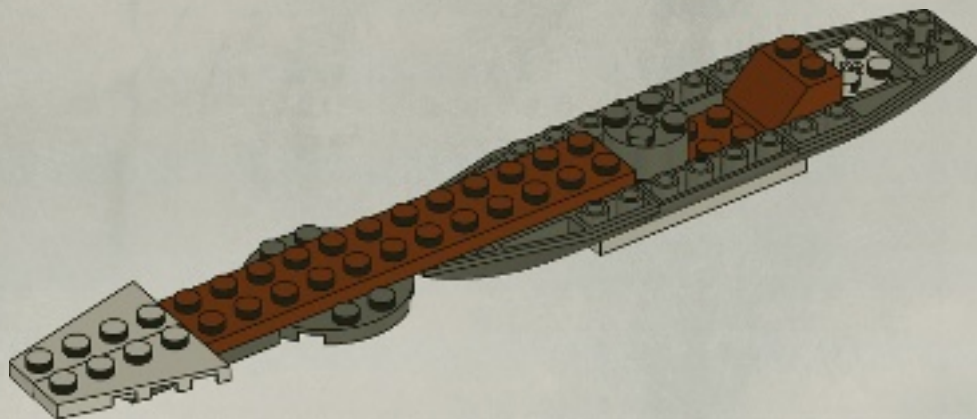

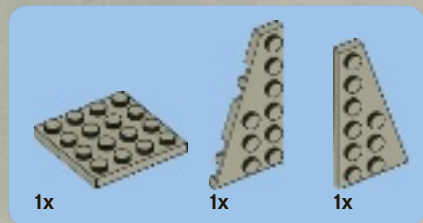

10

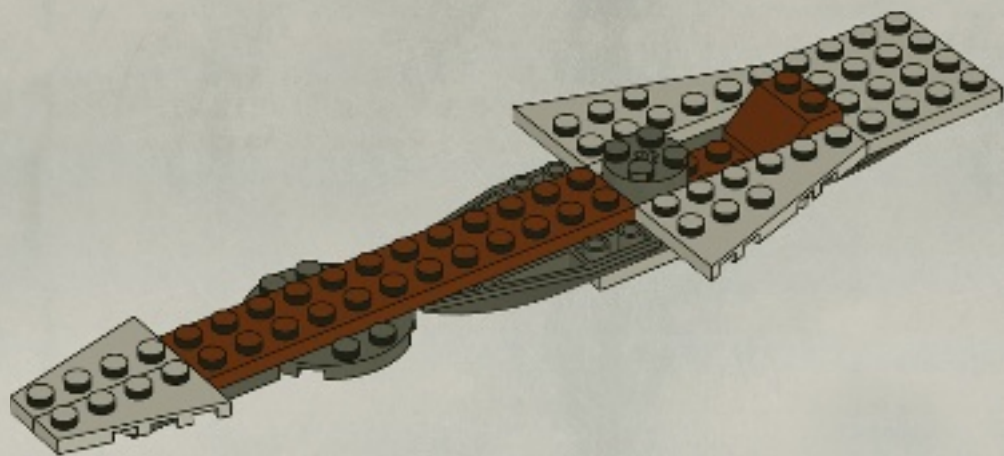



11

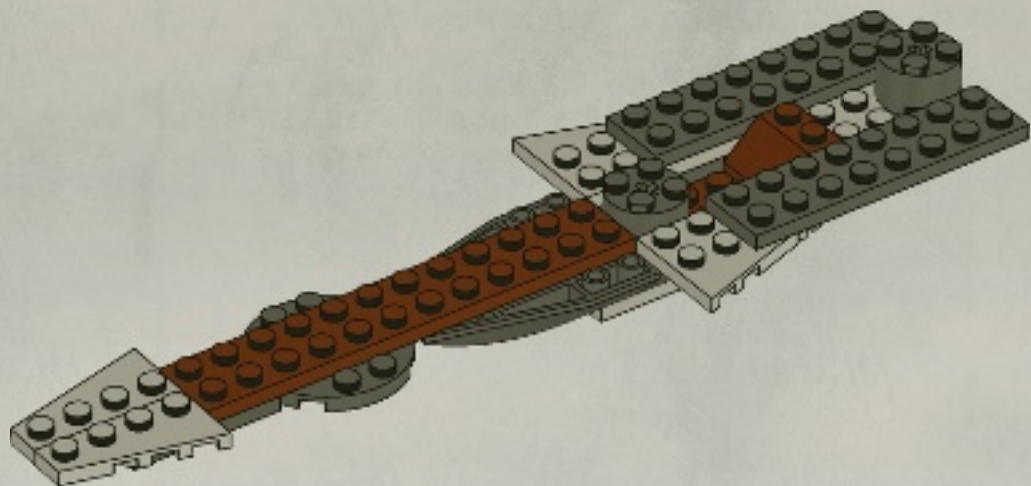



1x



3x

# 12

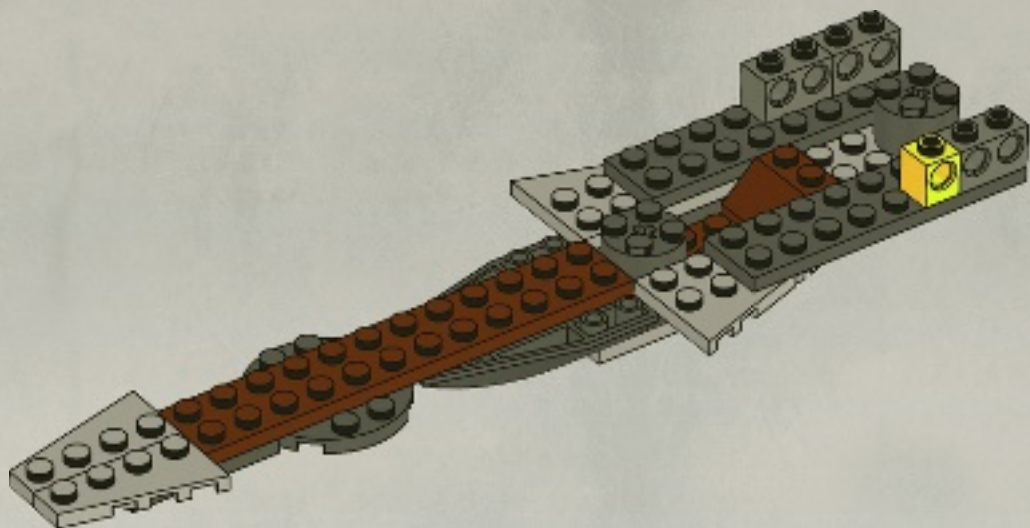





1x



1x

# 13

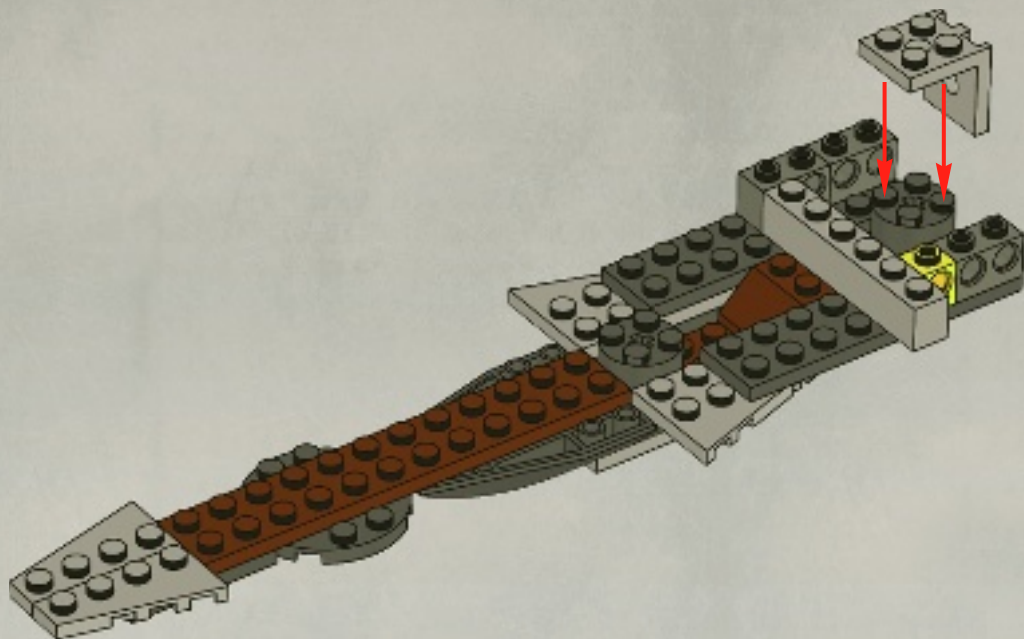



1x



1x

# 14

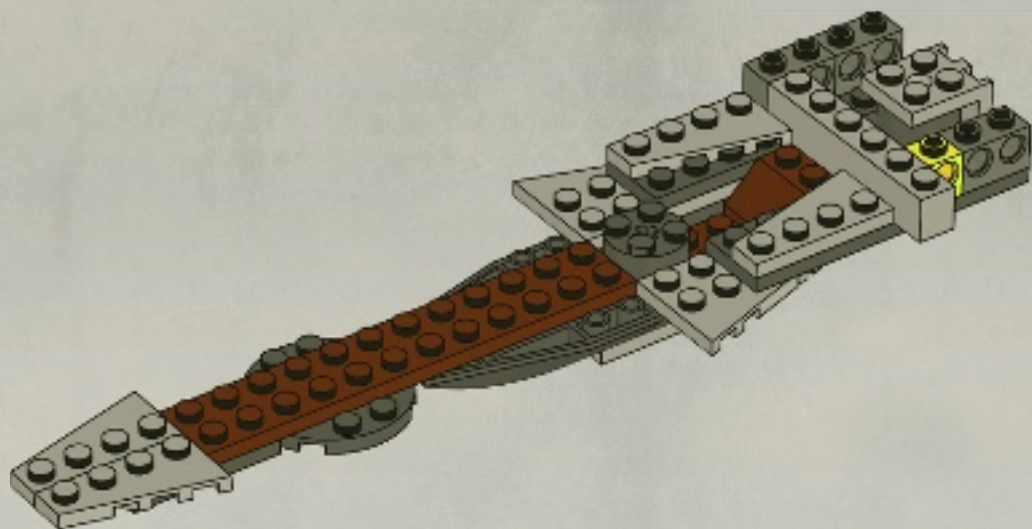



1x



2x

15

1



2

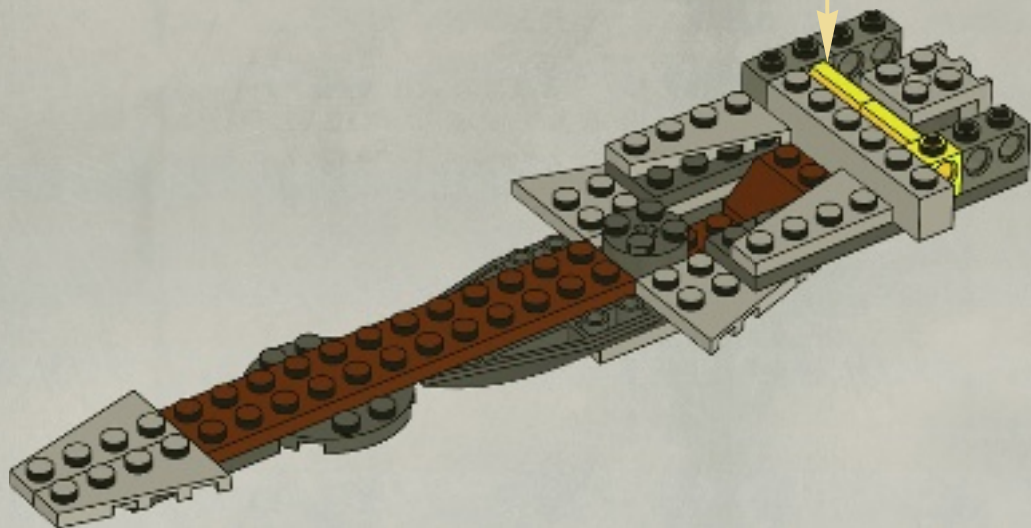



2x

16

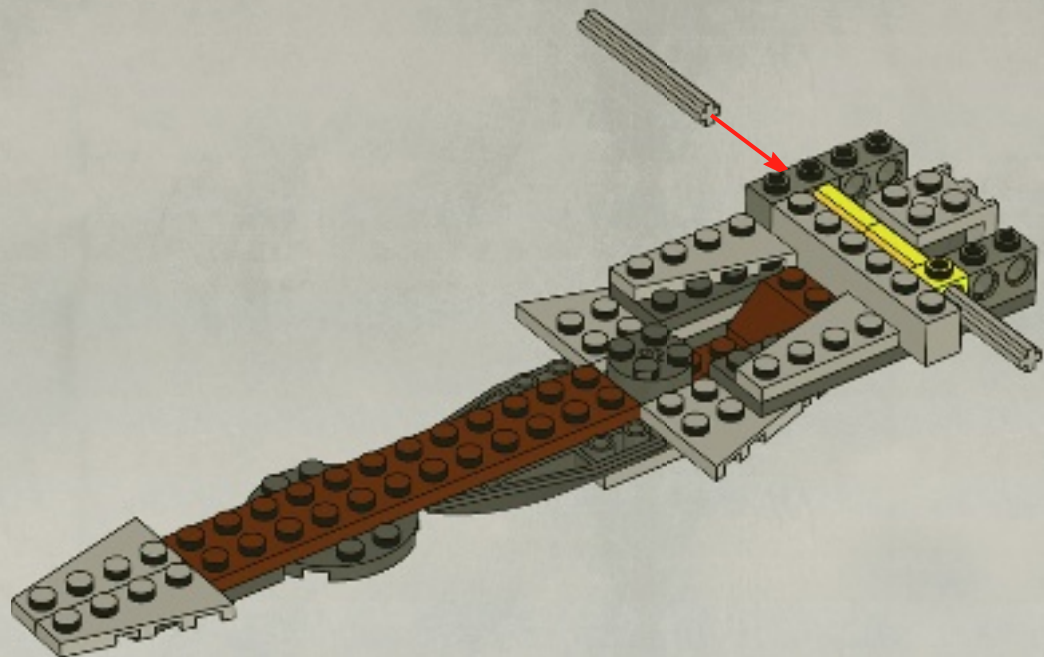



1x



1x

17

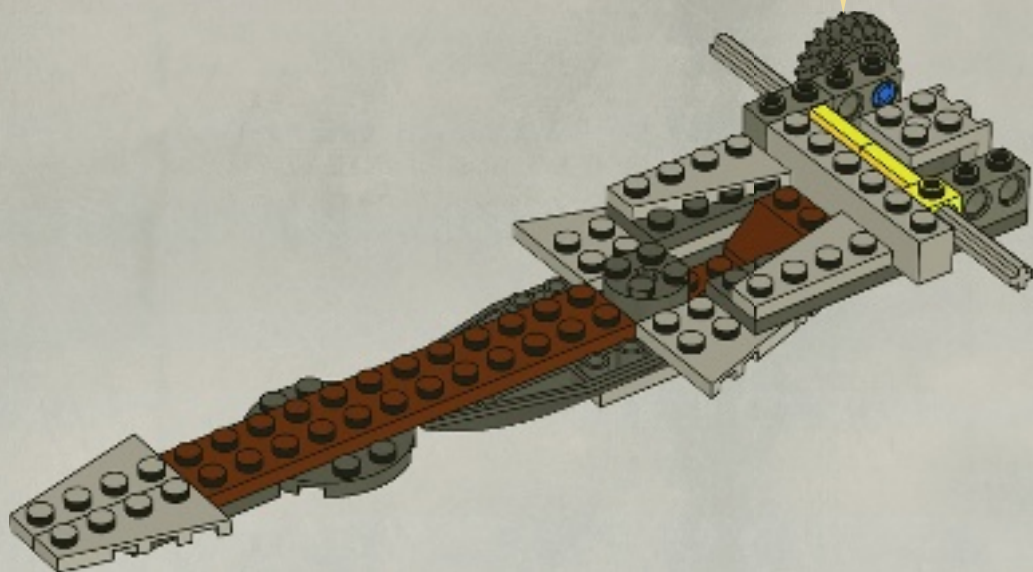
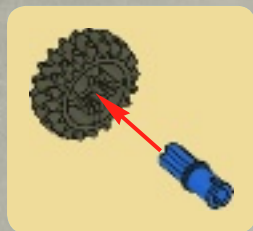



1x



1x

# 18

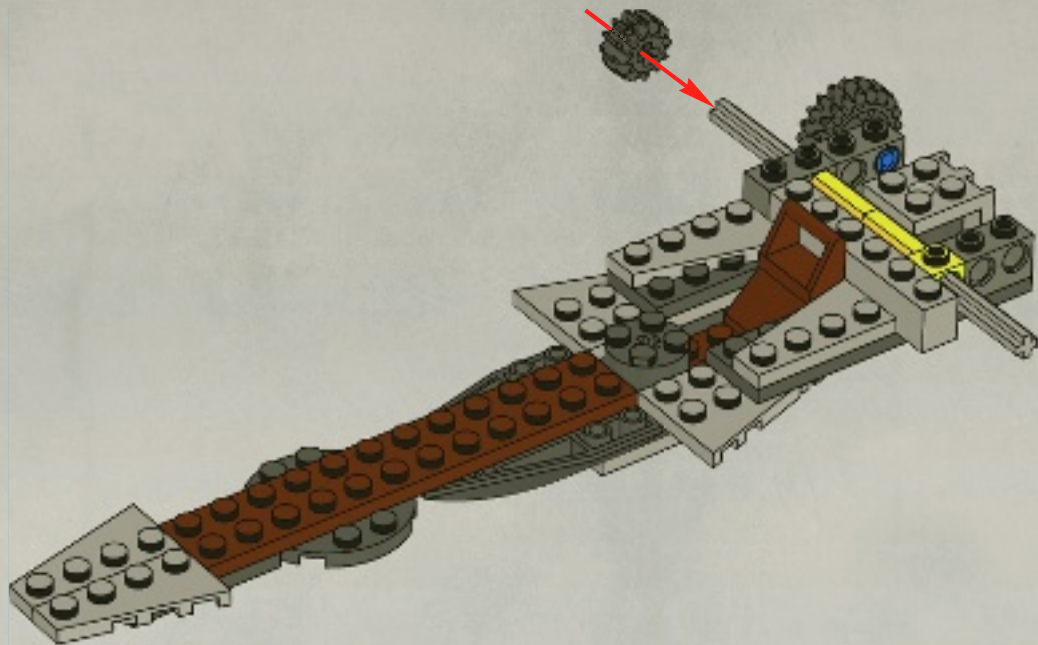





1x



1x

# 19

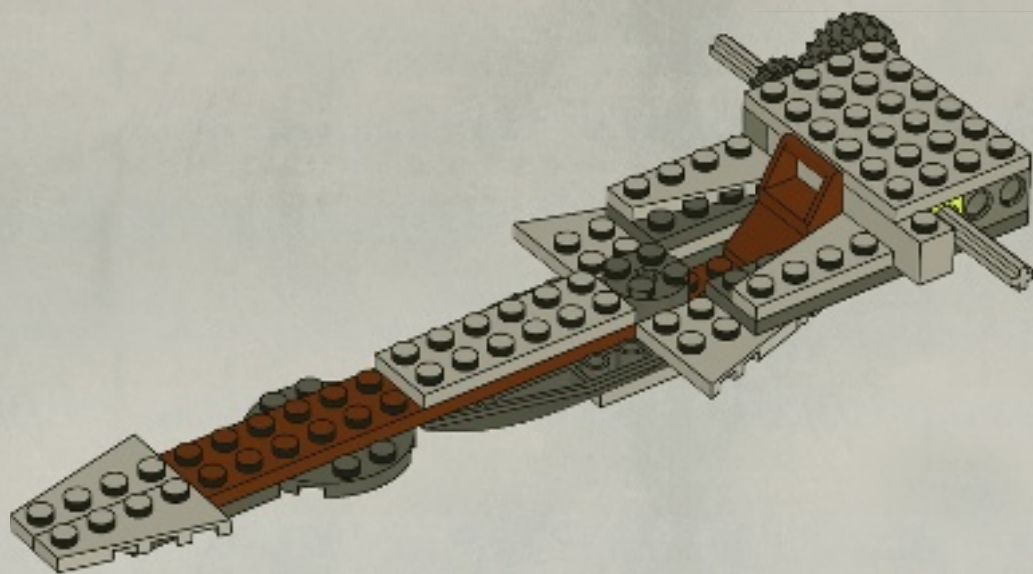



2x



1x

# 20

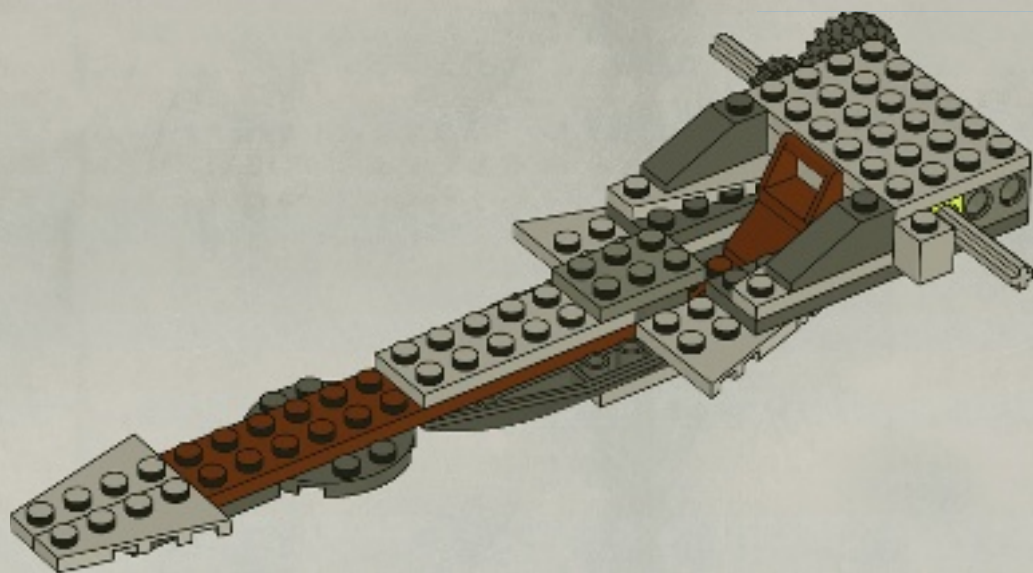

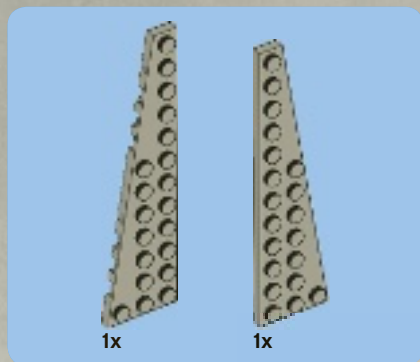

21

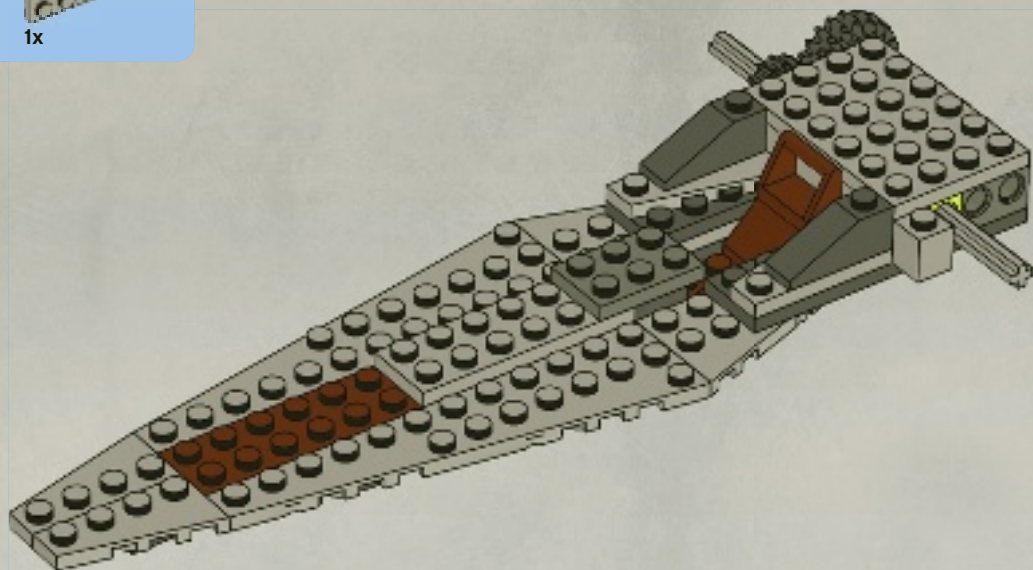

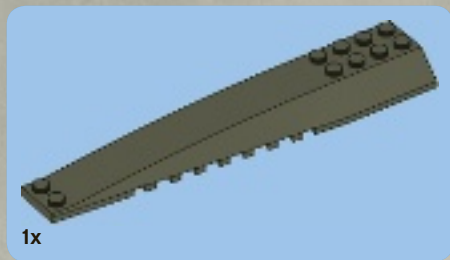

22

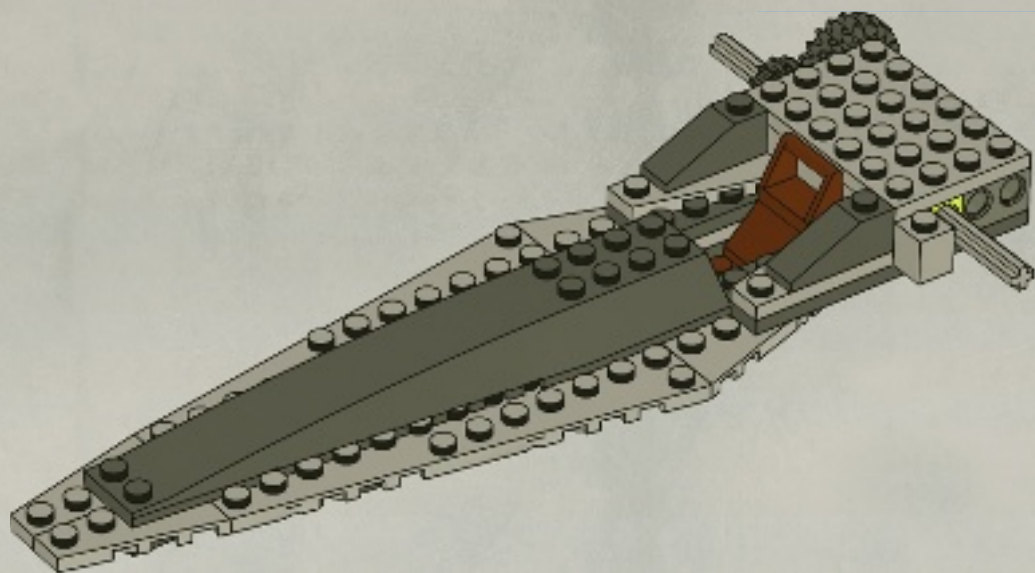



2x

23

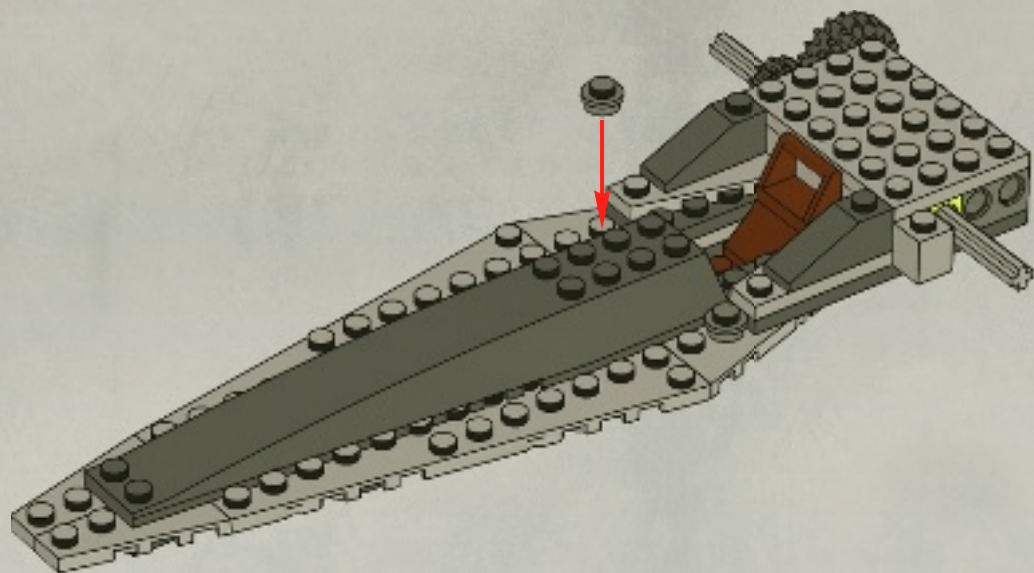



2x



2x

# 24

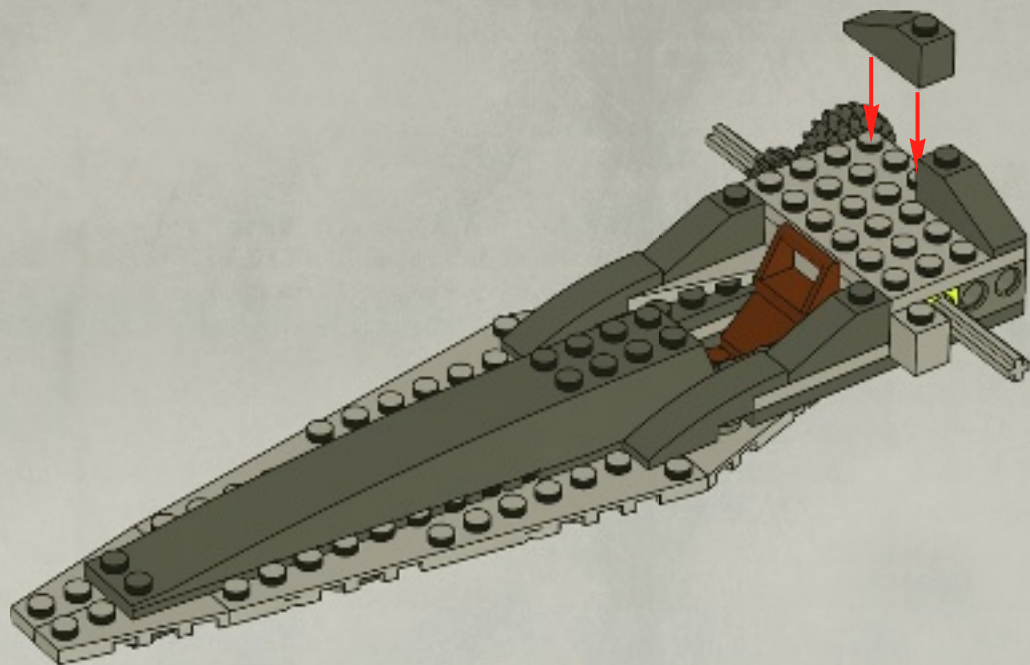





2x



2x

# 25

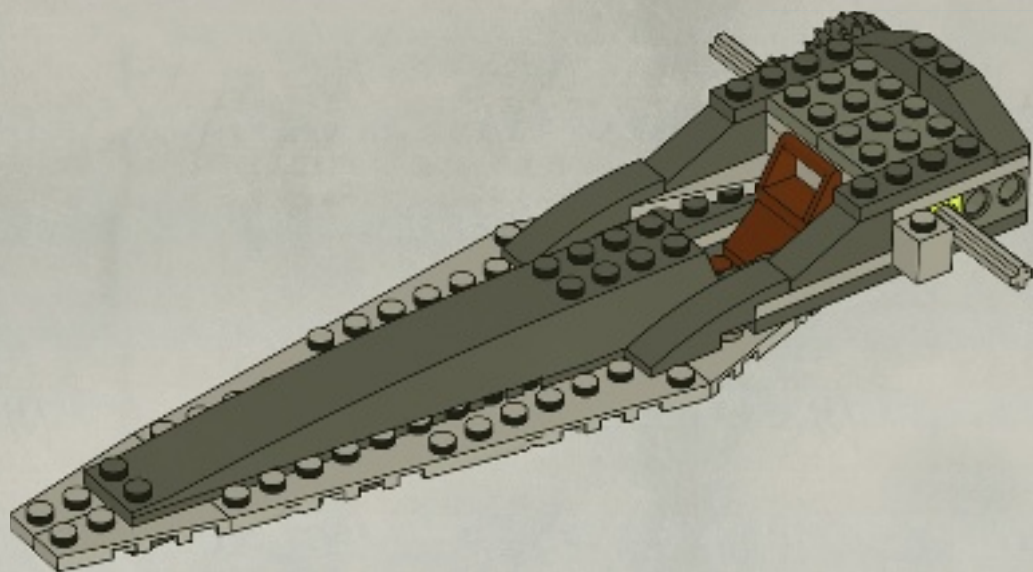



1x



4x

# 26

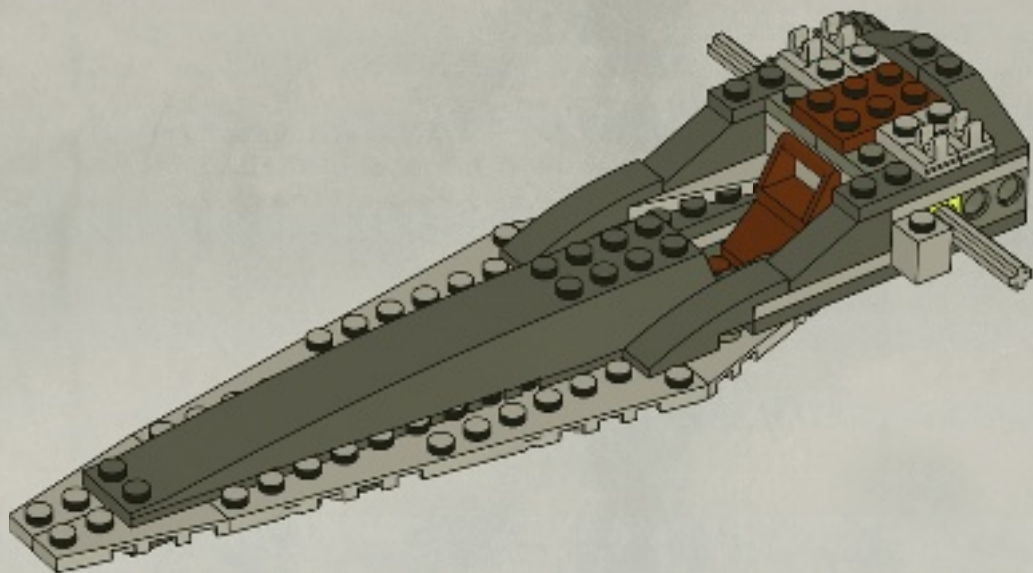



2x

27

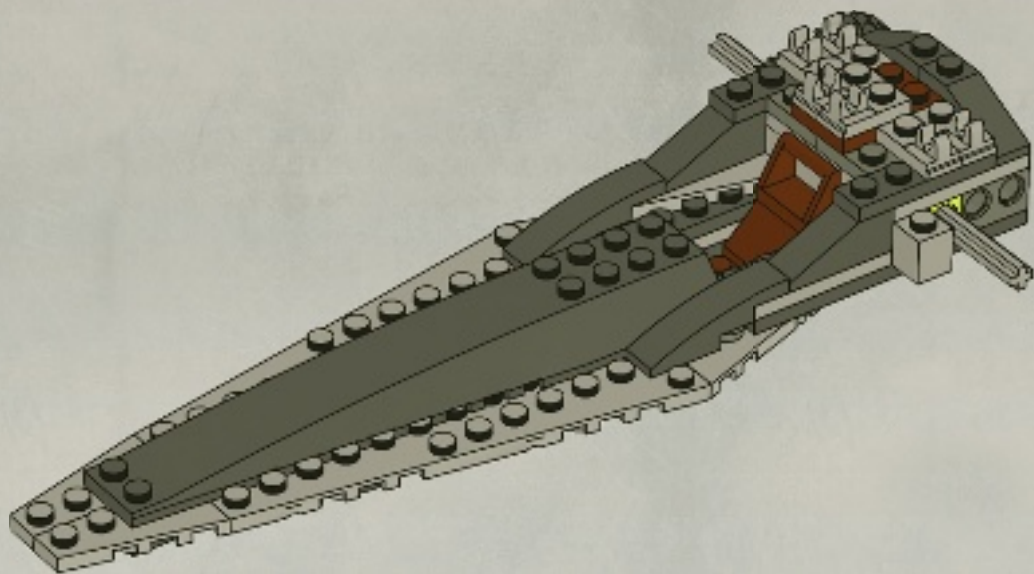



2x

28

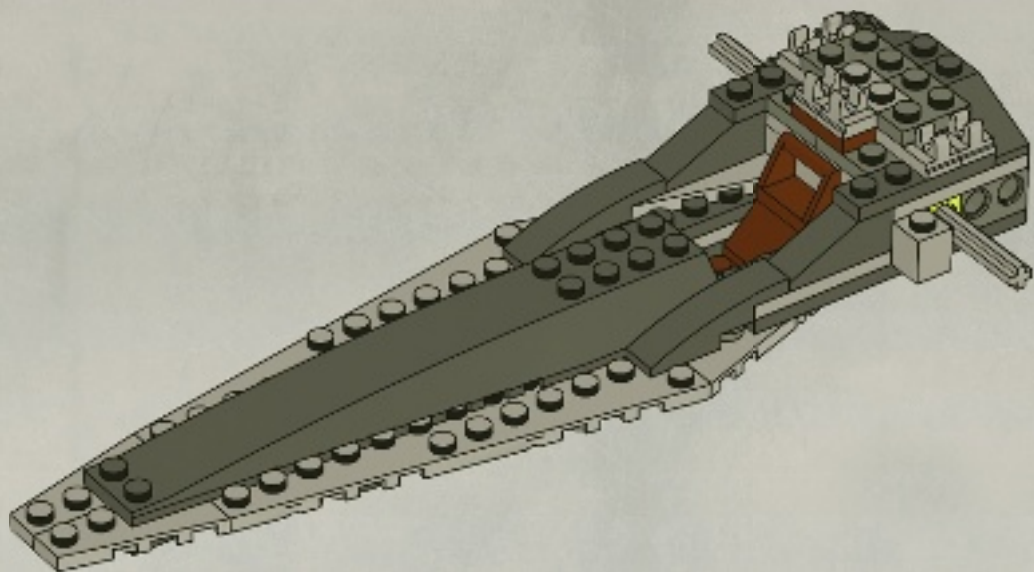



1x



1x

# 29

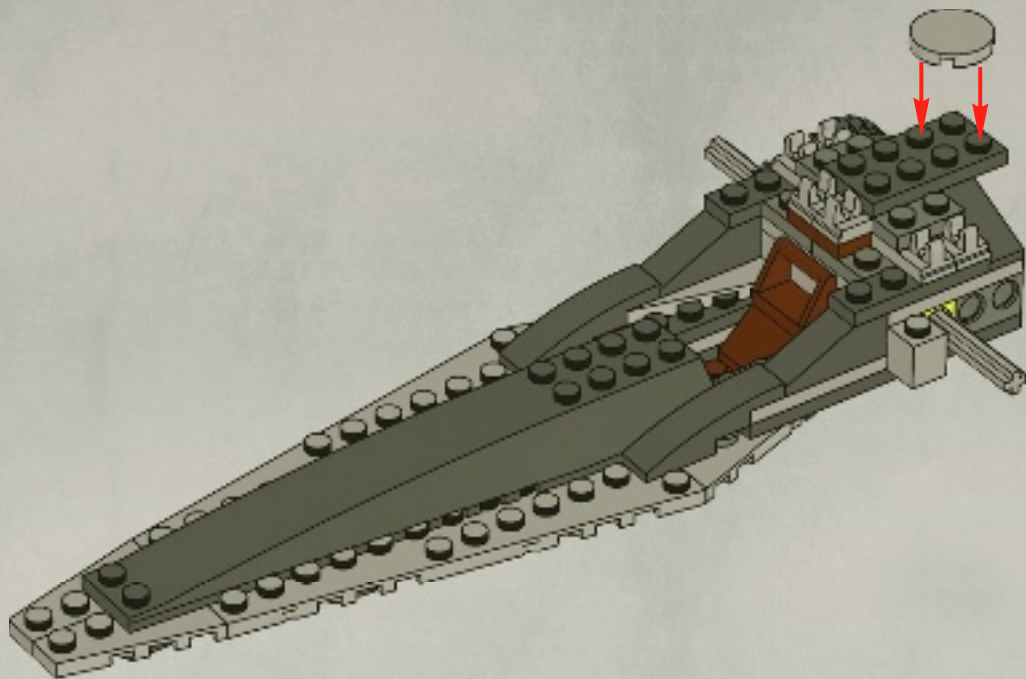

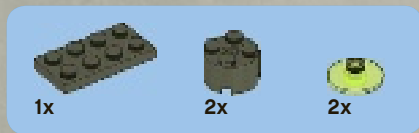

30

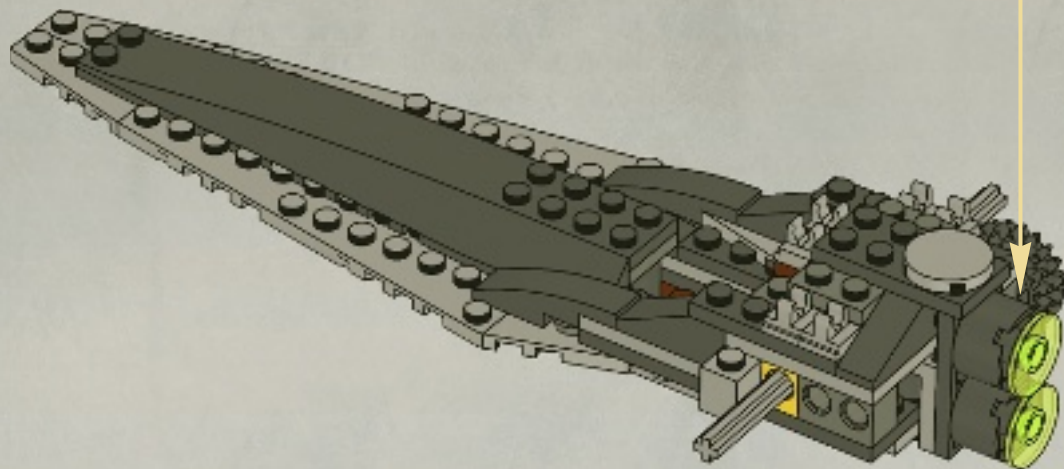
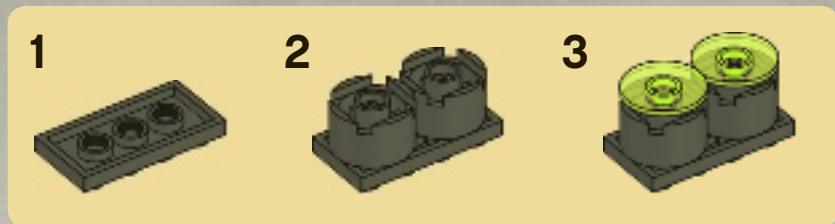



31

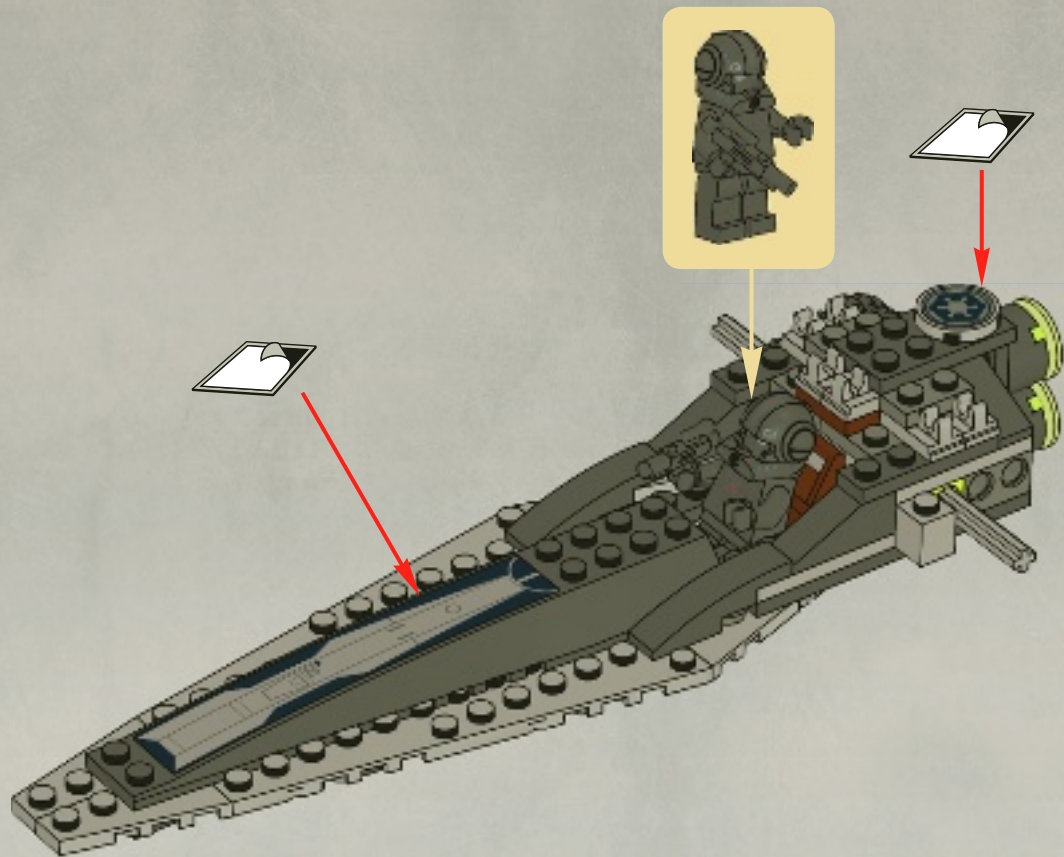



1x

32

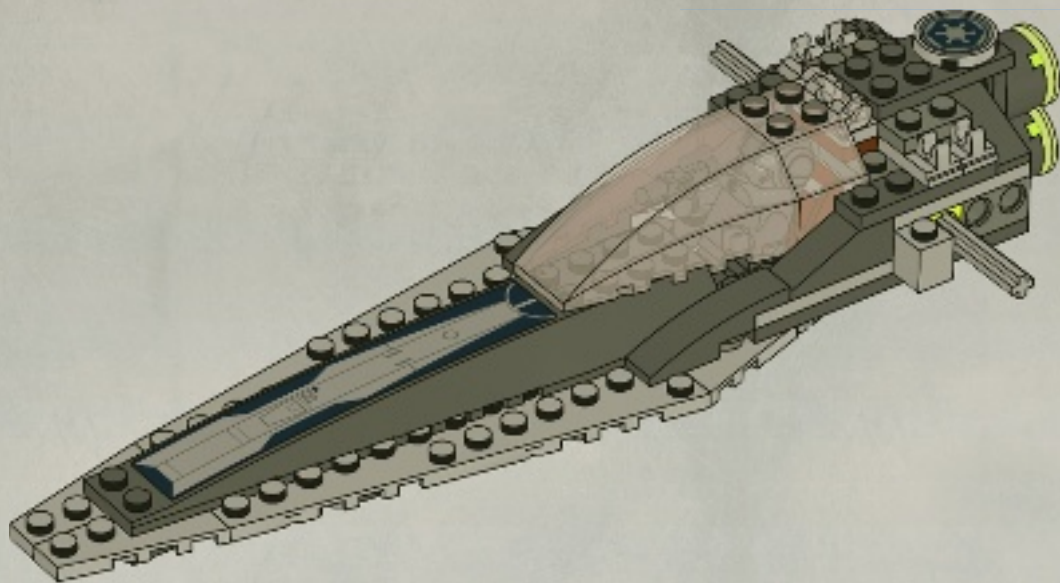

34



1x

33

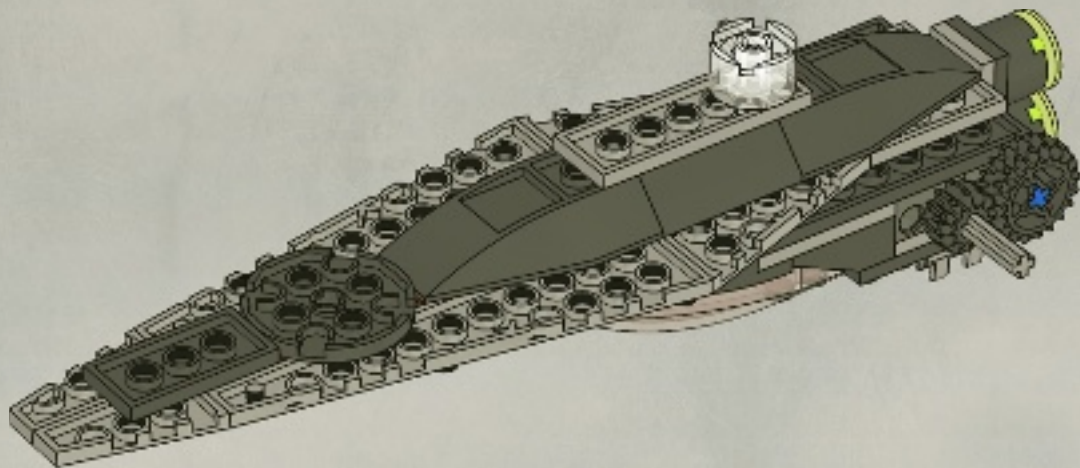

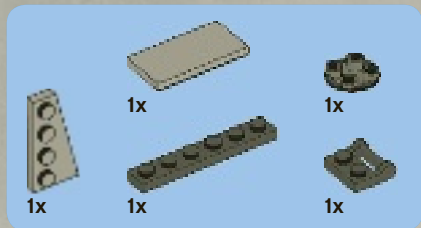

# 34

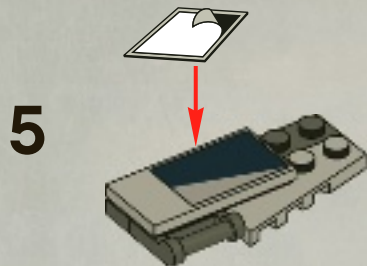
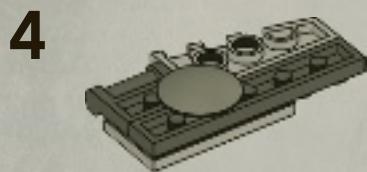
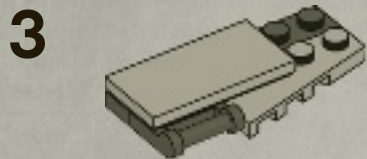
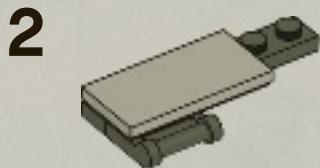
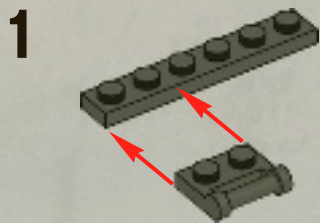

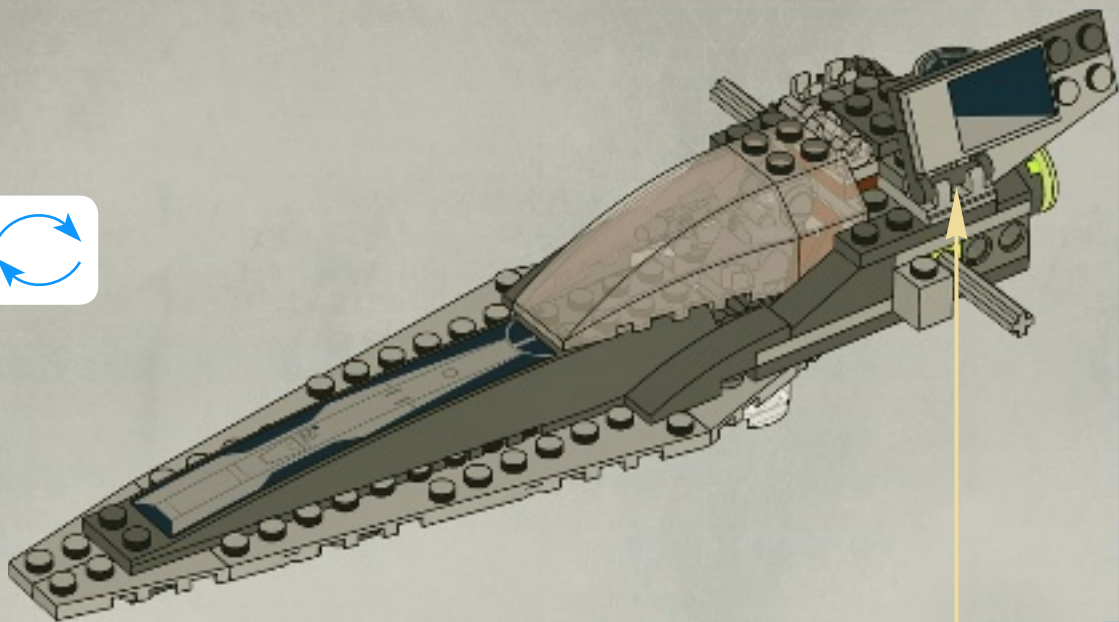

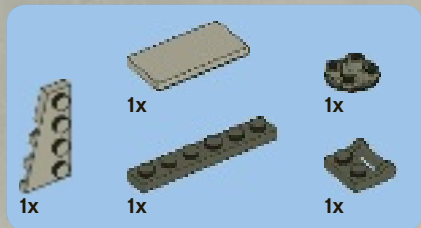

35

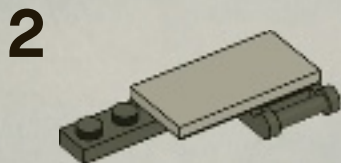
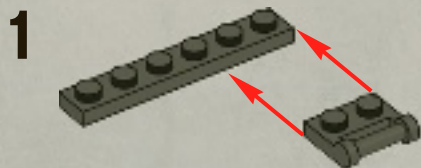

3

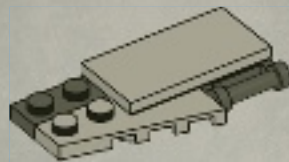

4

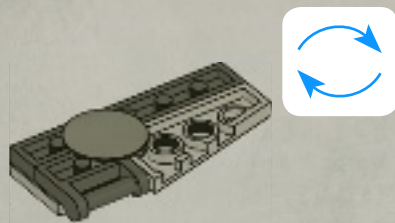

5

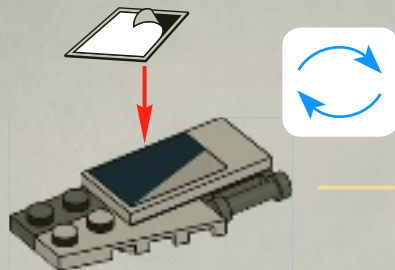



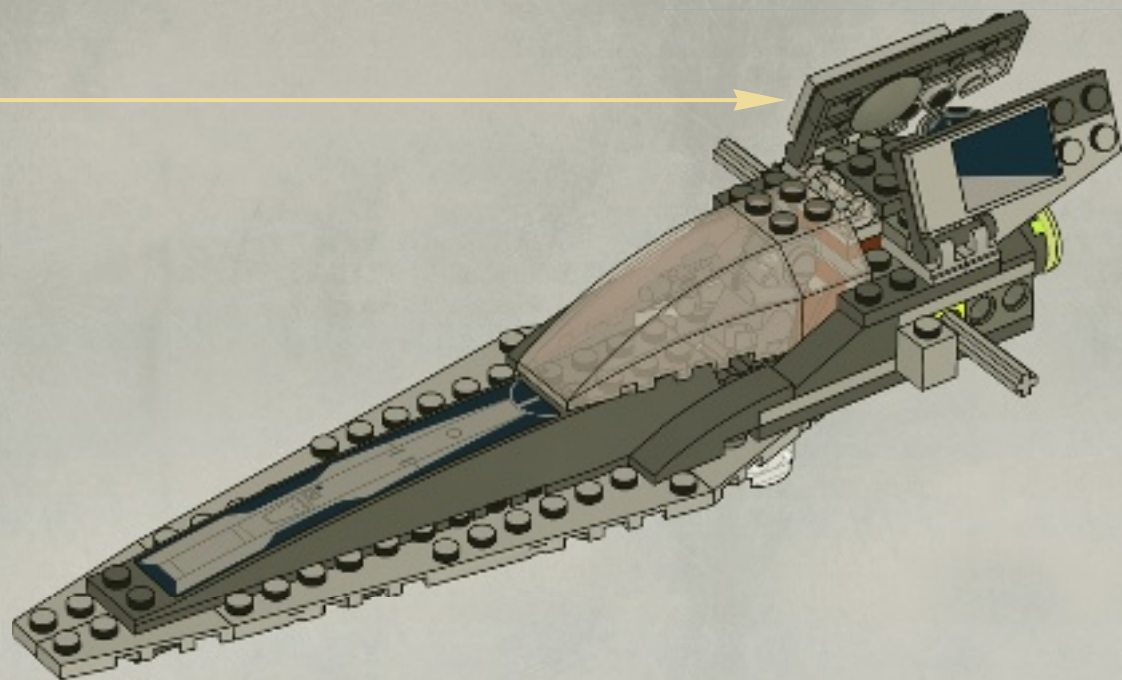



1x



1x

# 36

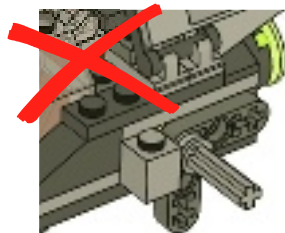
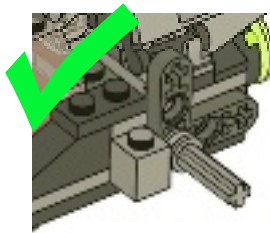
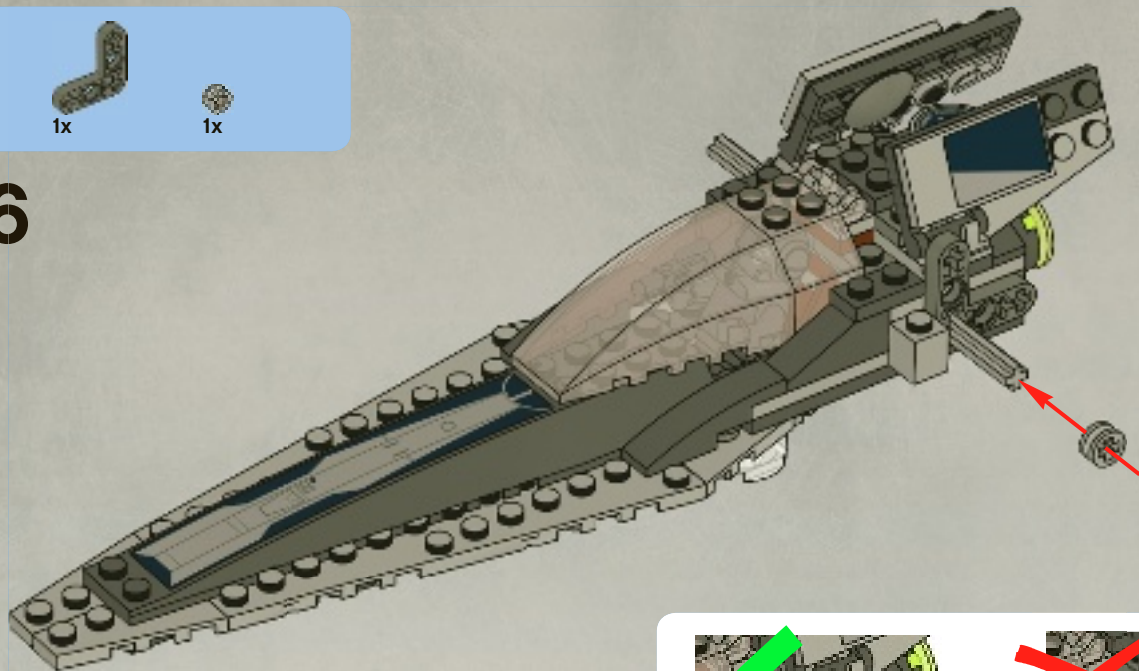



2x



1x

1



1x



2x

2

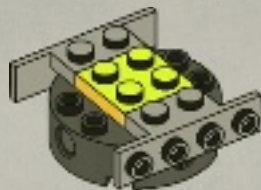

2x

3





2x



1x



2x

4



2x



1x



2x

5





1x

6



1x

7

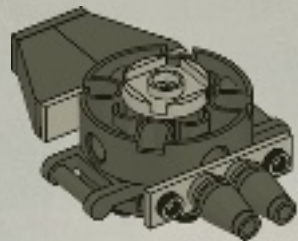

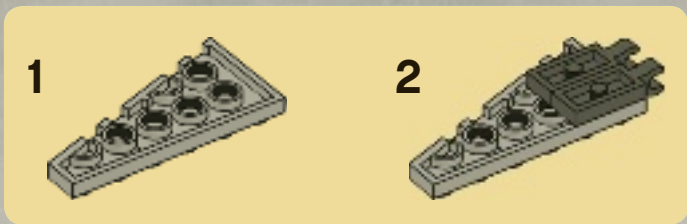
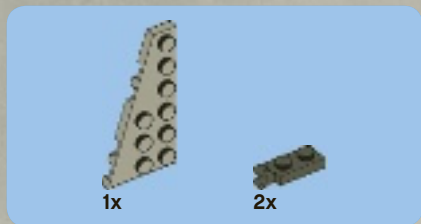

8

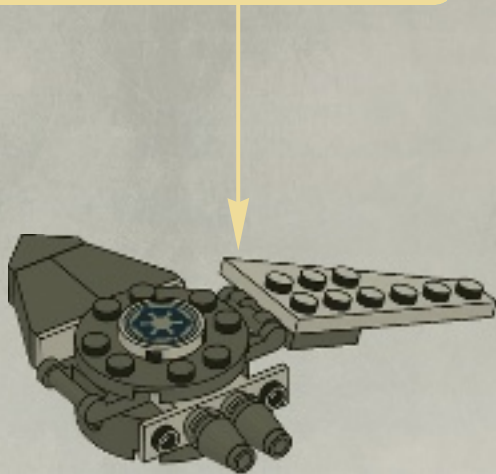





1x



2x

9

1

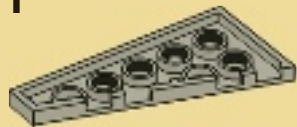

2

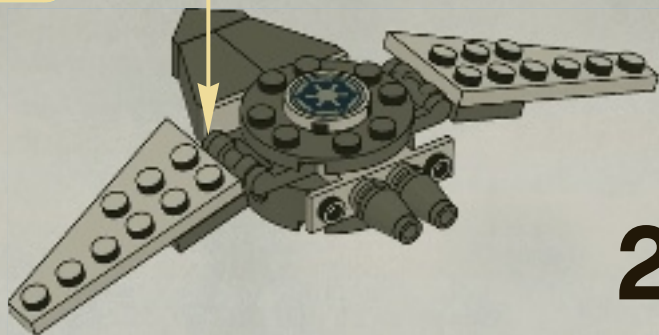
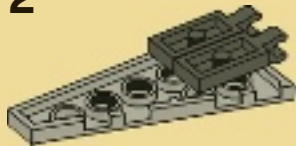

2x

37

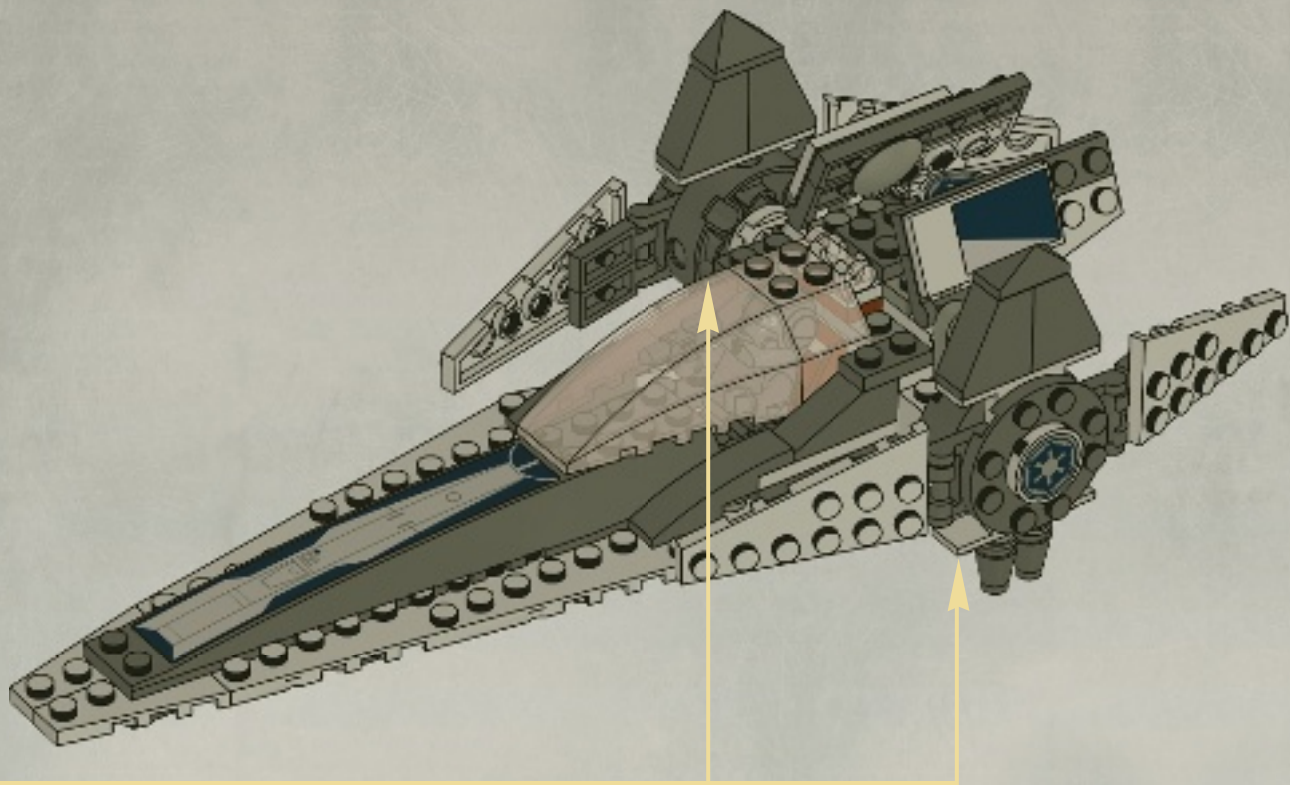

38

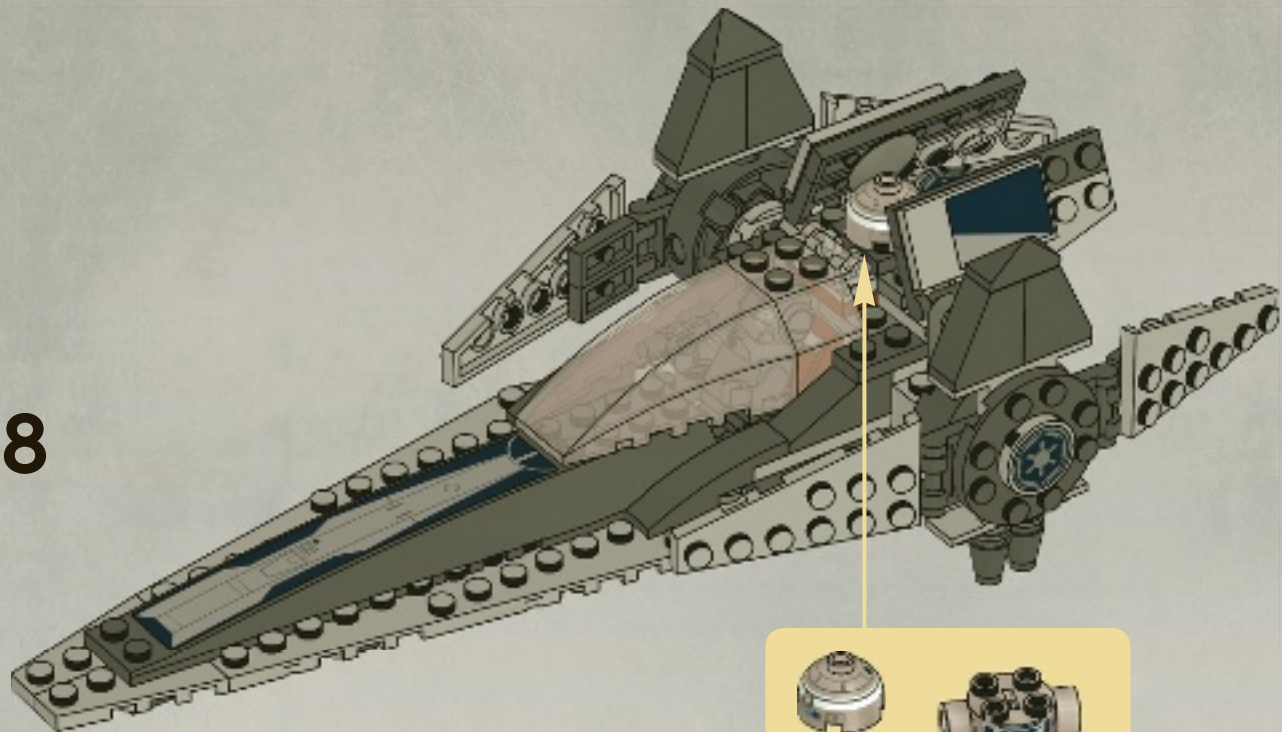

39

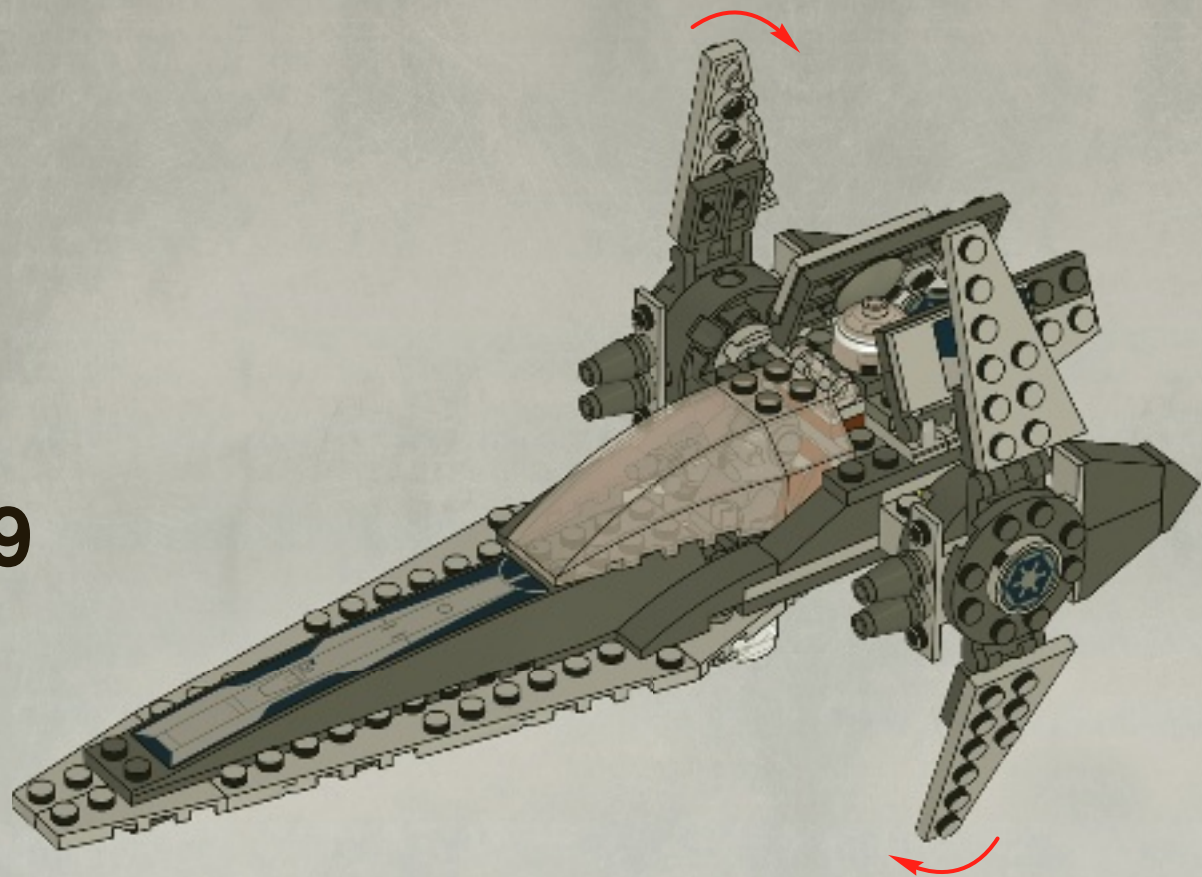



2x  
4597462



1x  
4613929



1x  
4613931

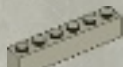

1x  
4211393

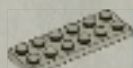

2x  
4211452



1x  
4243797



6x  
4598526



1x  
4211573



2x  
4211639



2x  
4560183



4x  
4282740

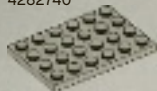

1x  
4211404

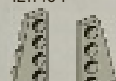

3x  
4211735



3x  
4211732

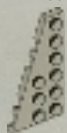

3x  
4282789

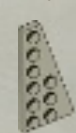

3x  
4282786

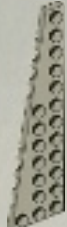

1x  
4208988

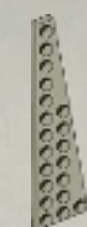

1x  
4209006



1x  
4211472



3x  
4211475



3x  
4211480



1x  
4210659



3x  
4210762



2x  
4210635



3x  
4211043



6x  
4210633



2x  
4278274

4278274



6x  
4225201



8x  
4535739



3x  
4515350



1x  
9339



1x  
4177430



1x  
4613921



1x  
4498713



2x  
303426



1x  
4200486



4x  
4529236



4x  
4515373



2x  
304826



4x  
428626

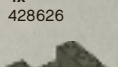

1x  
4603490



2x  
4522034

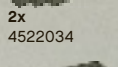

2x  
4180469

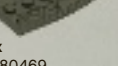

4x  
4529236



4x  
614326



2x  
4290056



2x  
371026



4x  
302026

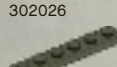

2x  
366626



1x  
4177431



1x  
4613864



1x  
4613853

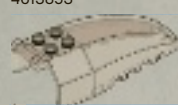

1x  
4598530



2x  
4225700



1x  
4211189



1x  
4211219



1x  
4211202



2x  
3006349



1x  
4142865



1x  
4206482



1x  
654124



2x  
302224



2x  
4519010



1x  
4143346



Customer Service

Kundenservice

Service Consommateurs

Servicio Al Consumidor

[www.lego.com/service](http://www.lego.com/service) or dial



: 00800 5346 5555

: 1-800-422-5346



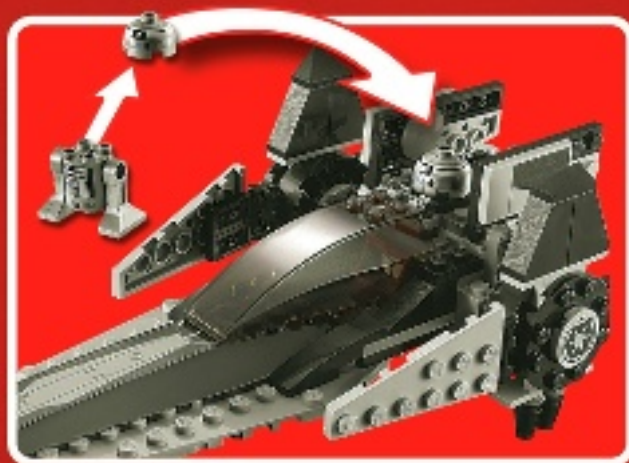

R2-Q2™



Imperial Pilot™



# STAR WARS™

# LEGO





7913



7914



7929



7930



LEGO

NINJAGO

Masters of Spinjitzu



NINJAGO.COM



[www.LEGOclub.com](http://www.LEGOclub.com)



LEGO® Club Email



LEGO® Club Magazine

SIGN UP ONLINE!

[www.LEGOclub.com](http://www.LEGOclub.com)



00800 5346 5555\*



1-866-534-6258 • 1-877-518-5346

US & Canada only

Outside continental

**LEGO club**  
**FREE! GRATIS! GRATUIT!**

- \* Freephone. Mobile charges may apply.
- \* Numéro sans frais. Des frais peuvent s'appliquer avec les téléphones cellulaires.
- \* Gebührenfrei, Kosten für Anrufe aus Mobilfunknetzen können abweichen.
- \* Gratis telefonnummer vanaf vaste lijn.
- \* Det er et gratis nummer, når du ringer fra fasttelefon.
- \* Det är gratis, när du ringer från en fast telefon.
- \* Numéro sans frais. Des frais peuvent s'appliquer avec les téléphones portables.



# WIN!

Go to [www.LEGOsurvey.com/product](http://www.LEGOsurvey.com/product) to fill out a survey for a chance to win a cool LEGO® Product.

No purchase necessary.

Open to all residents where not prohibited.



[www.LEGO.com](http://www.LEGO.com)



## [www.LEGOsurvey.com/product](http://www.LEGOsurvey.com/product)

### GEWINNE!

Nimm an der Umfrage auf [www.LEGOsurvey.com/product](http://www.LEGOsurvey.com/product) teil und hab die Chance ein cooles LEGO® Produkt zu gewinnen!

Die Teilnahme am Gewinnspiel führt zu keinerlei Kaufverpflichtungen. Teilnahme in allen nicht ausgeschlossenen Ländern möglich.

### WIN!

Ga naar [www.LEGOsurvey.com/product](http://www.LEGOsurvey.com/product), vul een enquêteformulier in en maak kans op een cool LEGO® product.

Geen aankoopverplichting. Iedereen mag deelnemen, uitgezonderd ingezetenden van landen waar een enquêteverbod geldt.

### GAGNE !

Visite [www.LEGOsurvey.com/product](http://www.LEGOsurvey.com/product) pour répondre à un questionnaire et avoir une chance de gagner un produit LEGO® très cool !

Aucune obligation d'achat. Ouvert à tous les résidents des pays autorisés.

### 当てよう!

[www.LEGOsurvey.com/product](http://www.LEGOsurvey.com/product) にアクセスして、アンケートにご記入ください。当選者にはレゴ®製品を差し上げます。

お買い上げの必要はありません。禁止されていない限り、すべての皆様にご利用いただけます。