



THE HOBBIT™

AN UNEXPECTED JOURNEY

79004



Special The Hobbit Trilogy
Preview Set!

Ensemble spécial
de prévisualisation
Trilogie Le Hobbit!

Set especial:
¡Adelántate al estreno
de la trilogía de El Hobbit!

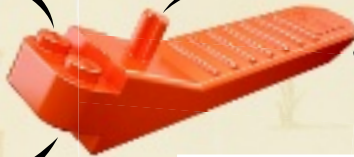

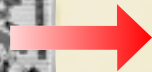
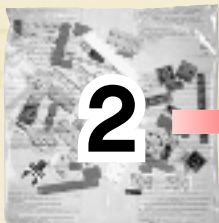
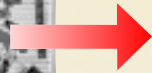

THE HOBBIT™
AN UNSPECTACULAR JOURNEY



OR HOBBIT™
MR. FRODO'S TRAVELER



EL HOBBIT™
MR. RINGS INSPIRADO

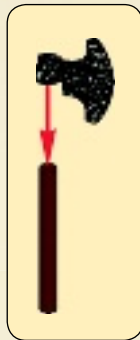
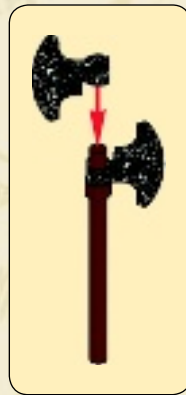
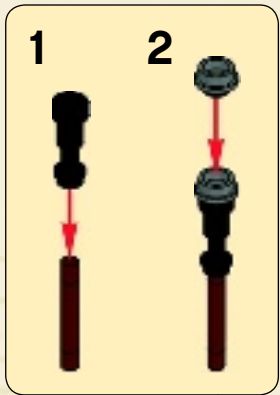
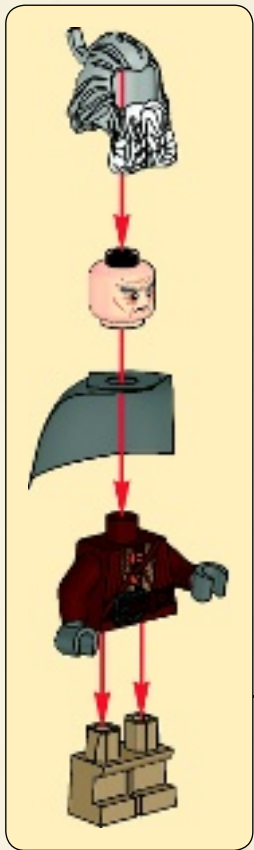
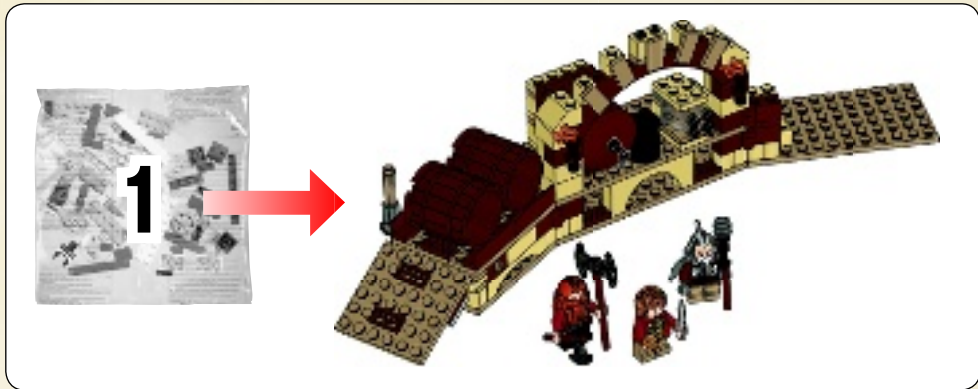

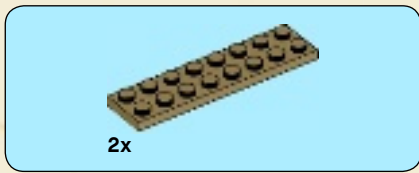

1

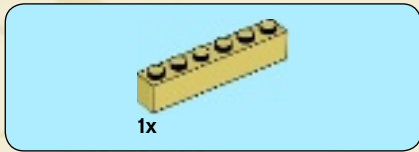
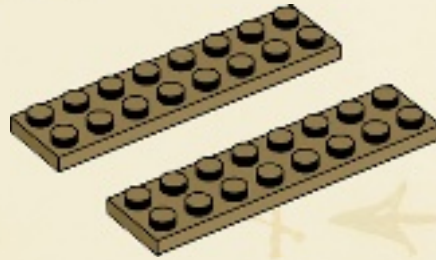

2

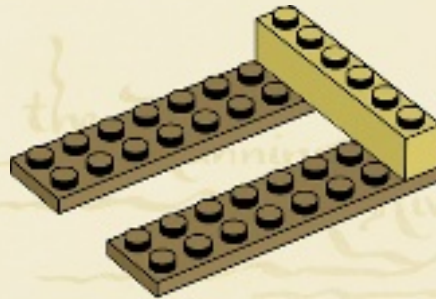

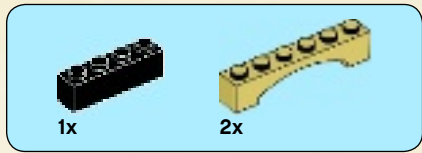

3

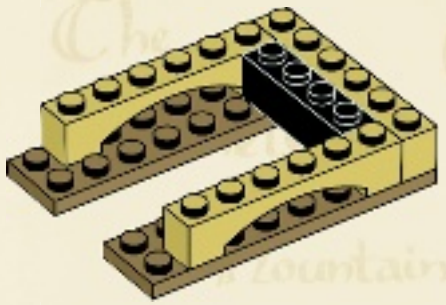

4

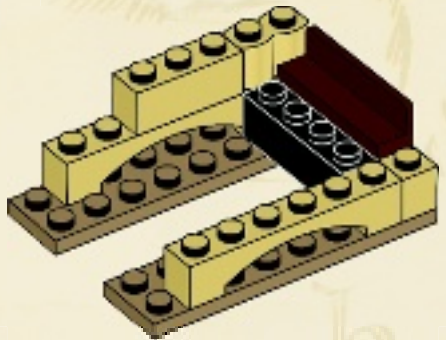

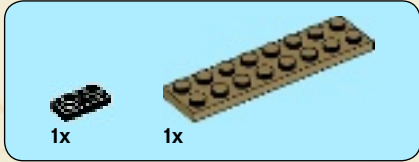
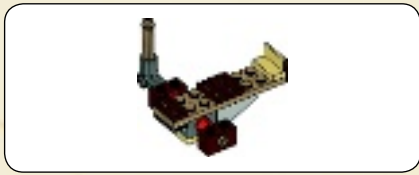

1

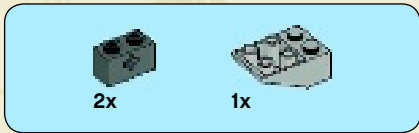
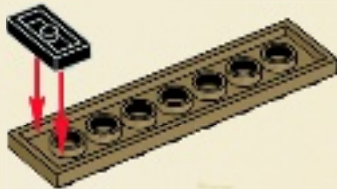

2

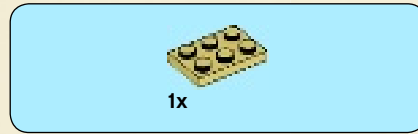
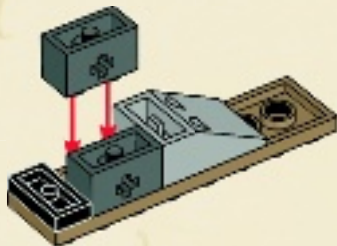

3



4

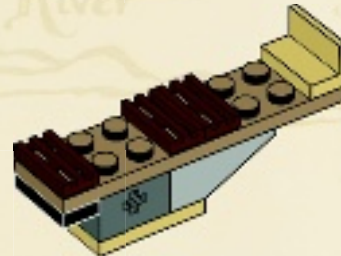
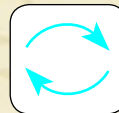



5

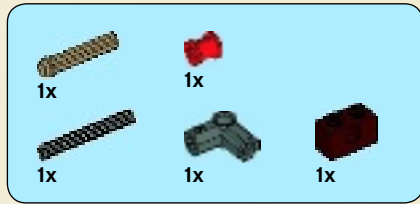
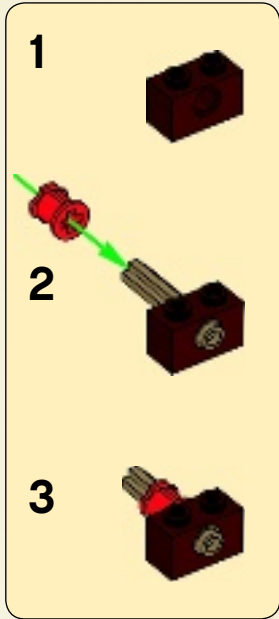

6

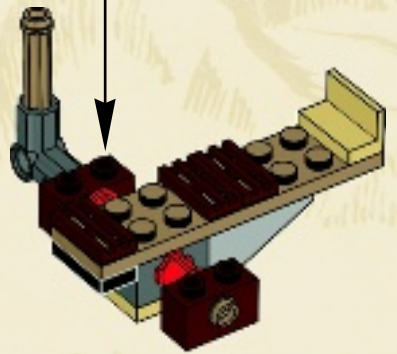
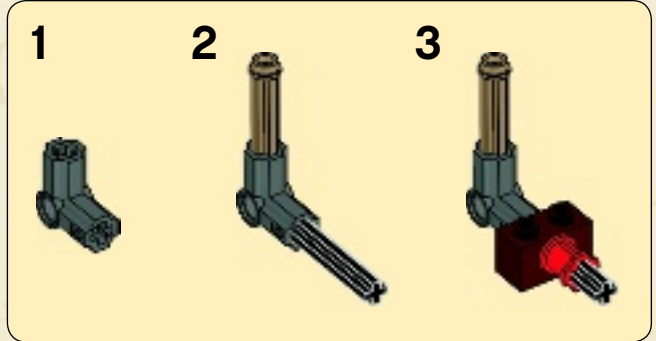

7

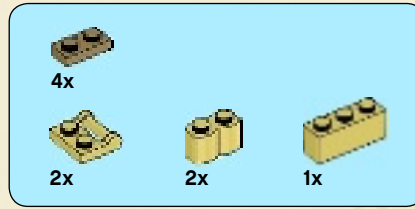
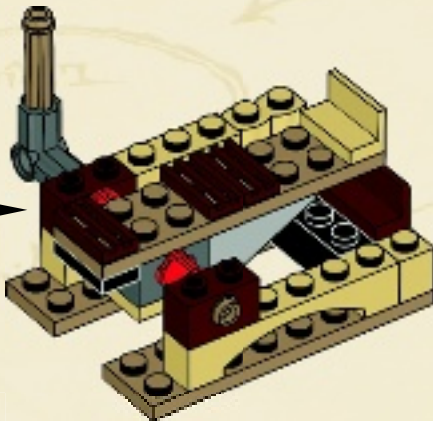

8

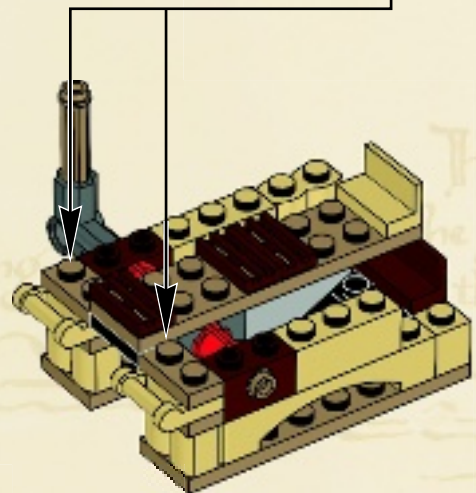
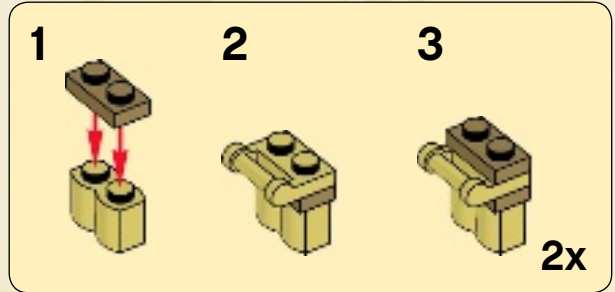

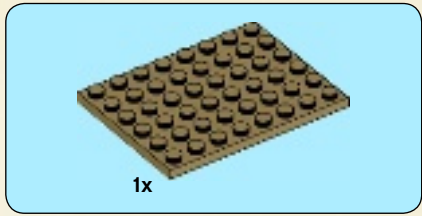
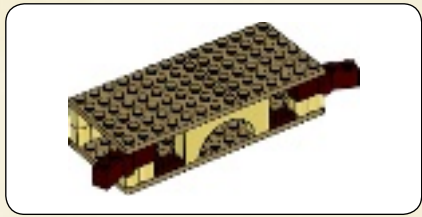

1x

1



2x

2x

2



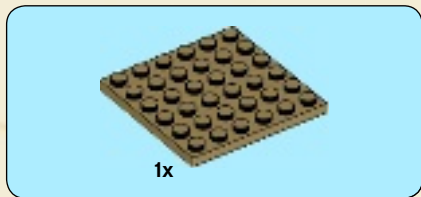

3

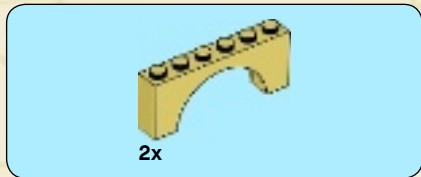
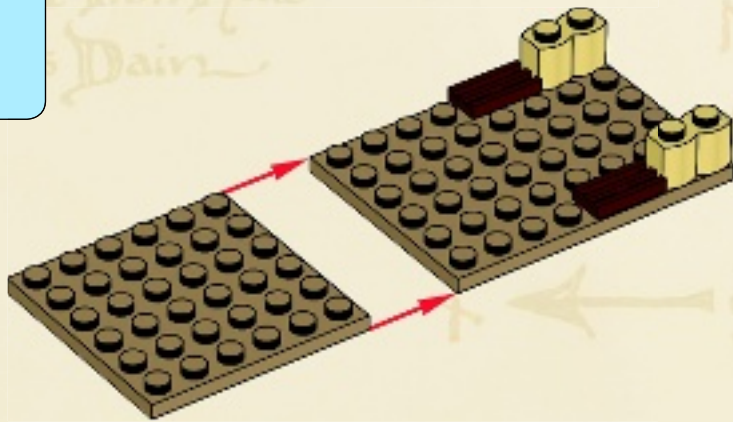

4

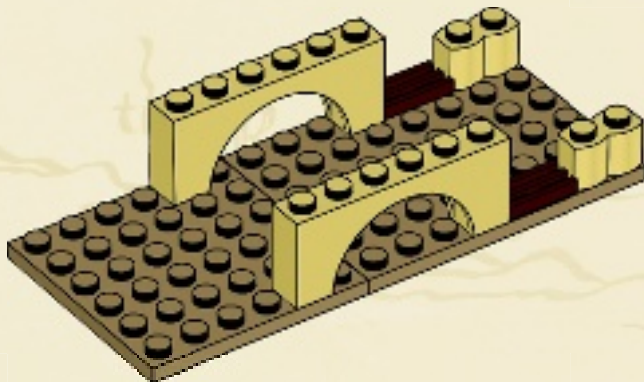

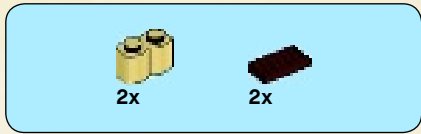

5

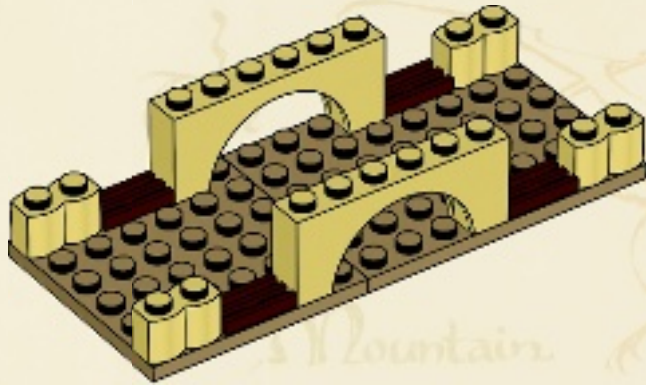

6

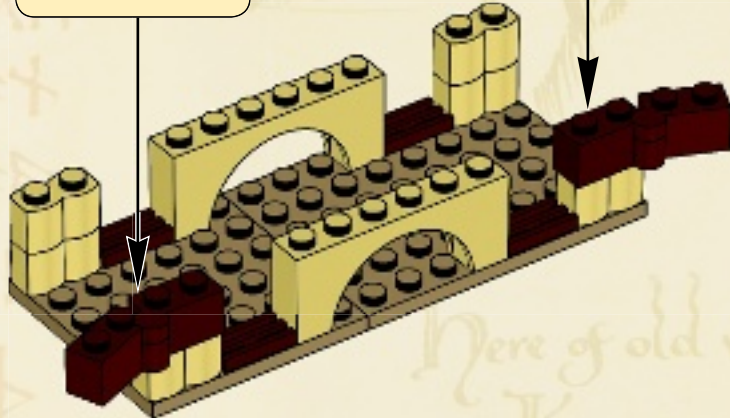
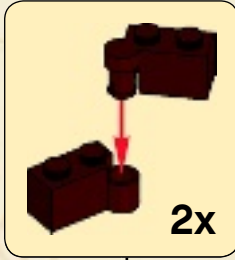

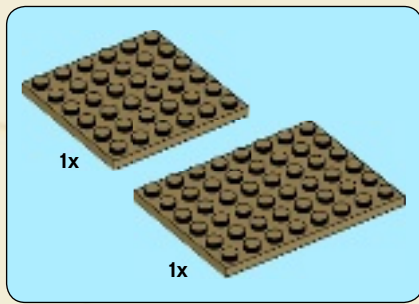

7

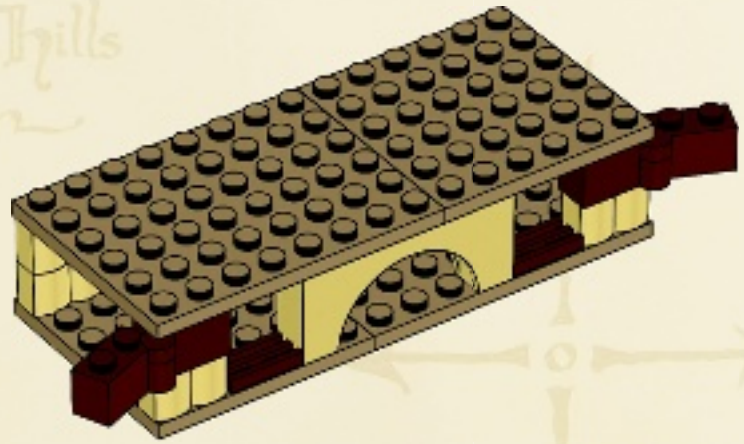

8

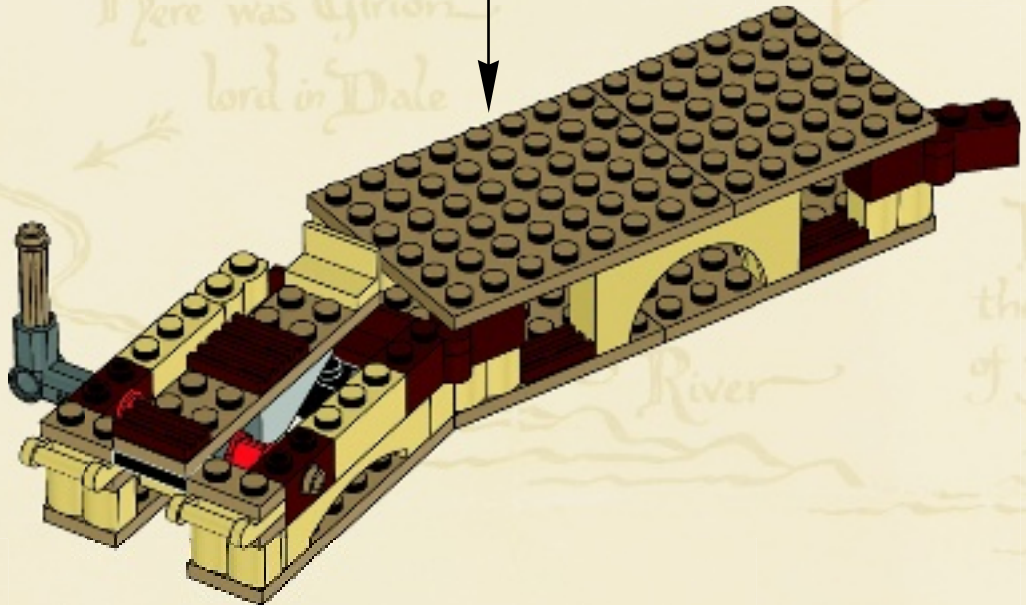

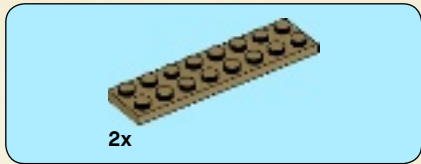

9

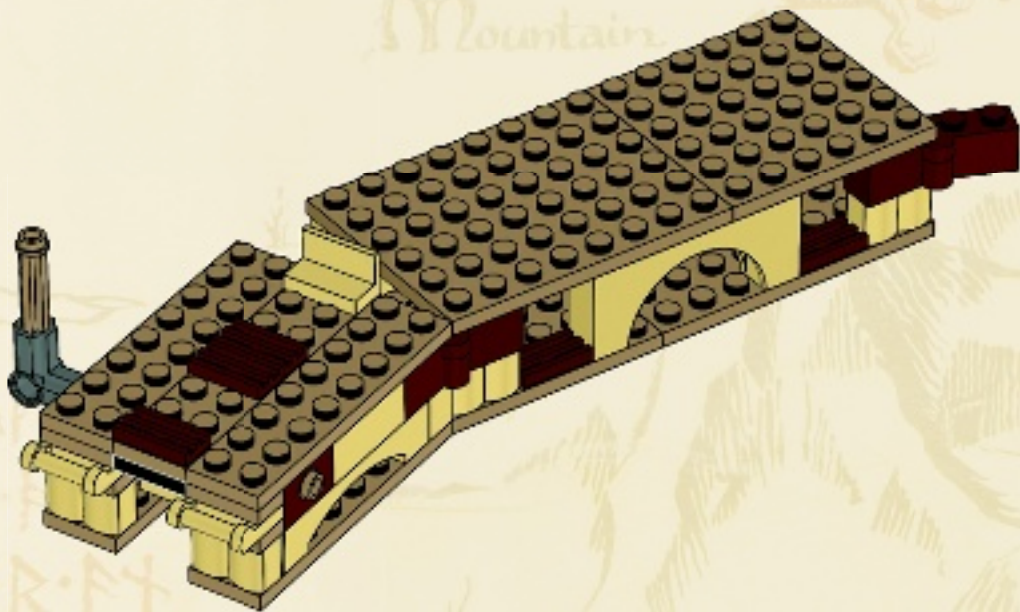



10

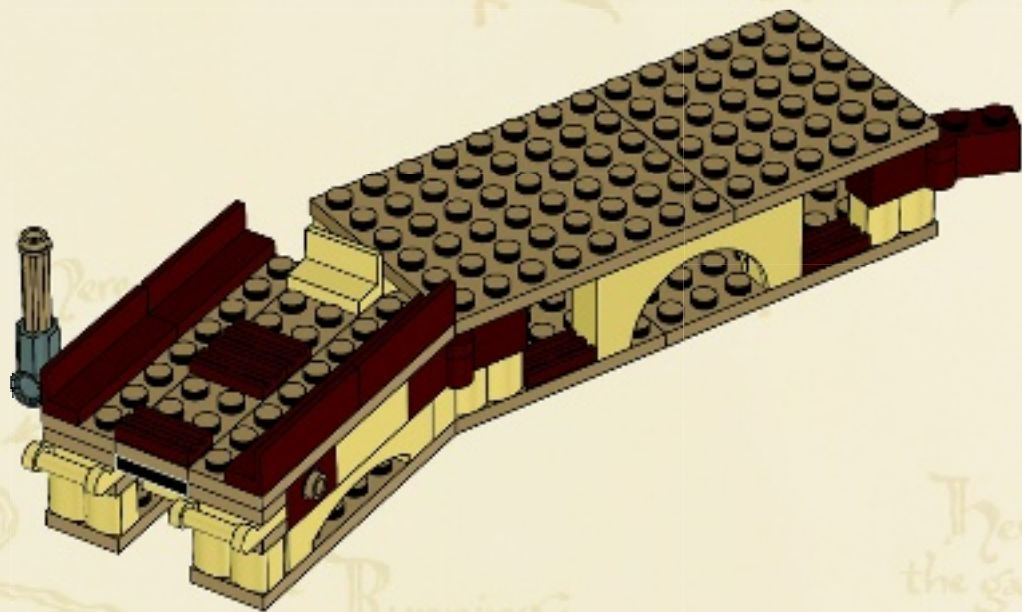



11

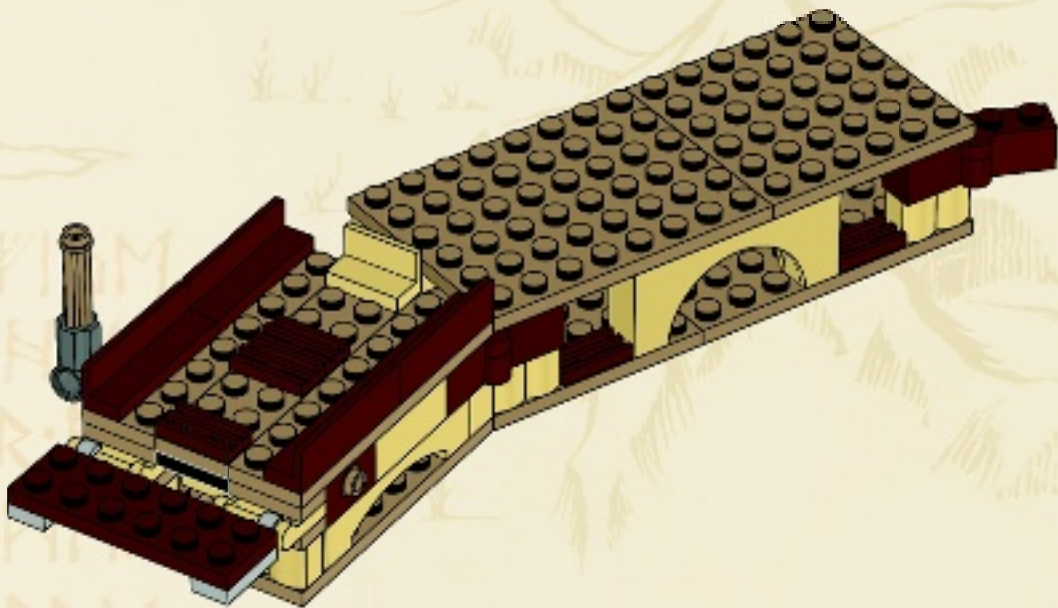
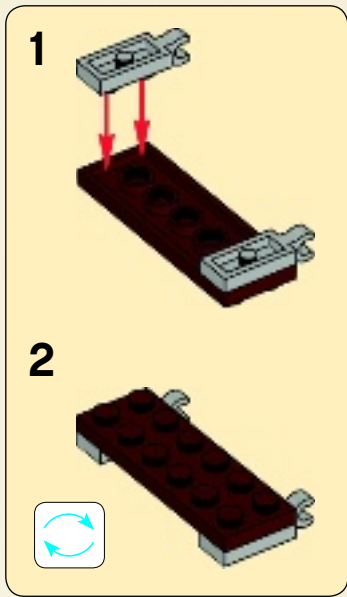

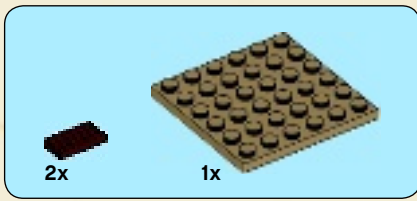

12

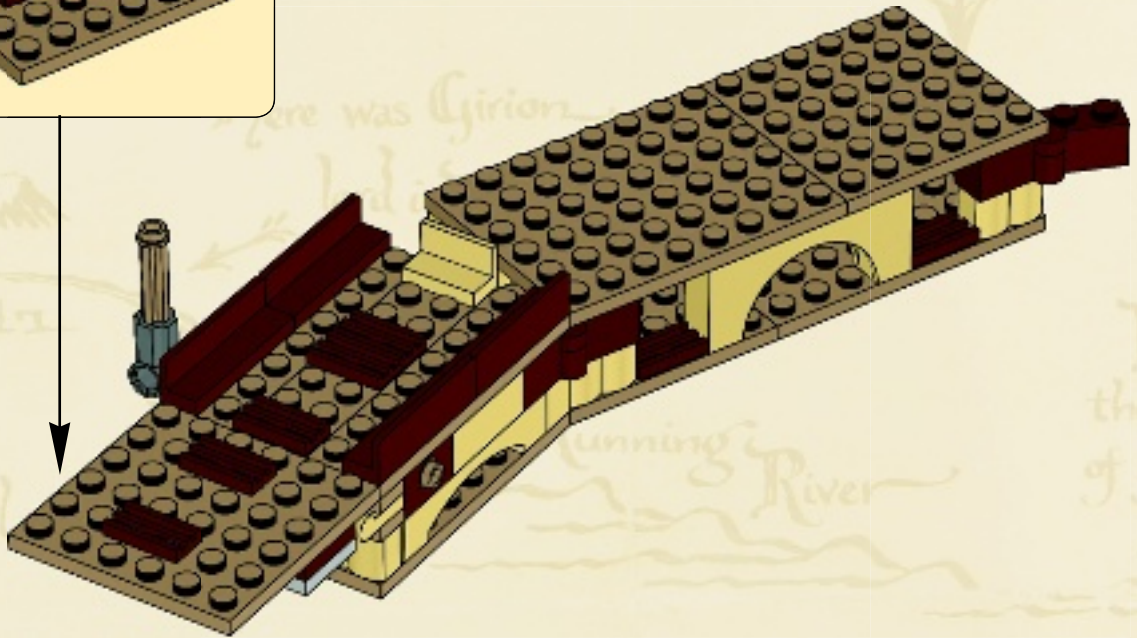
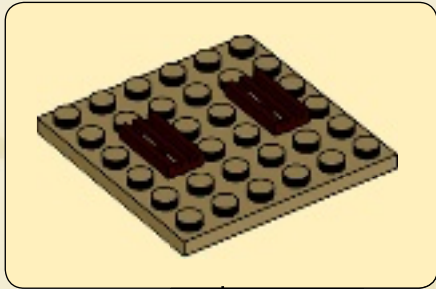

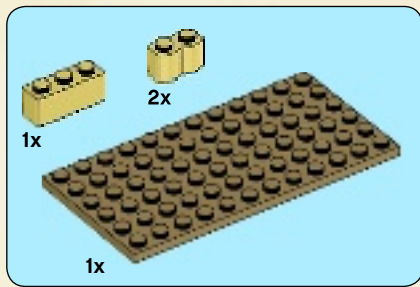

13

1

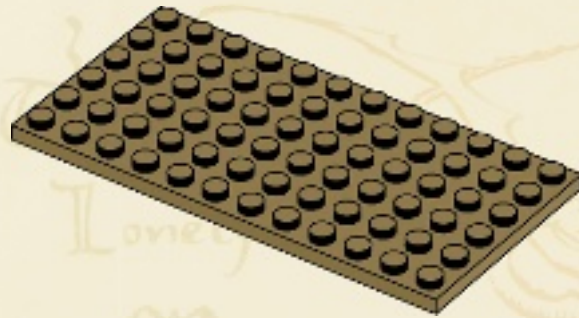

2



3



↑ East lie the Iron Hills
where is Dair

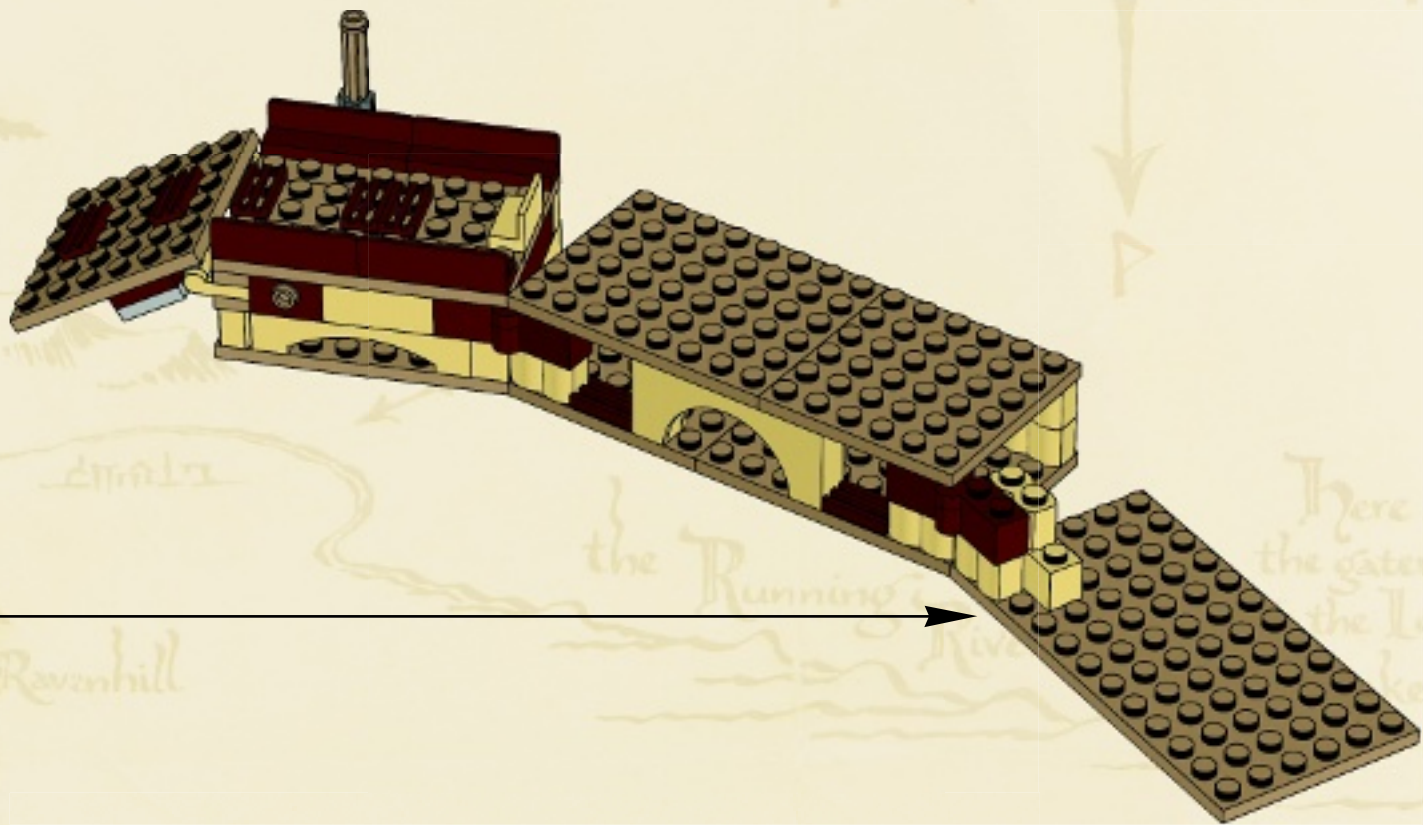



1x

14

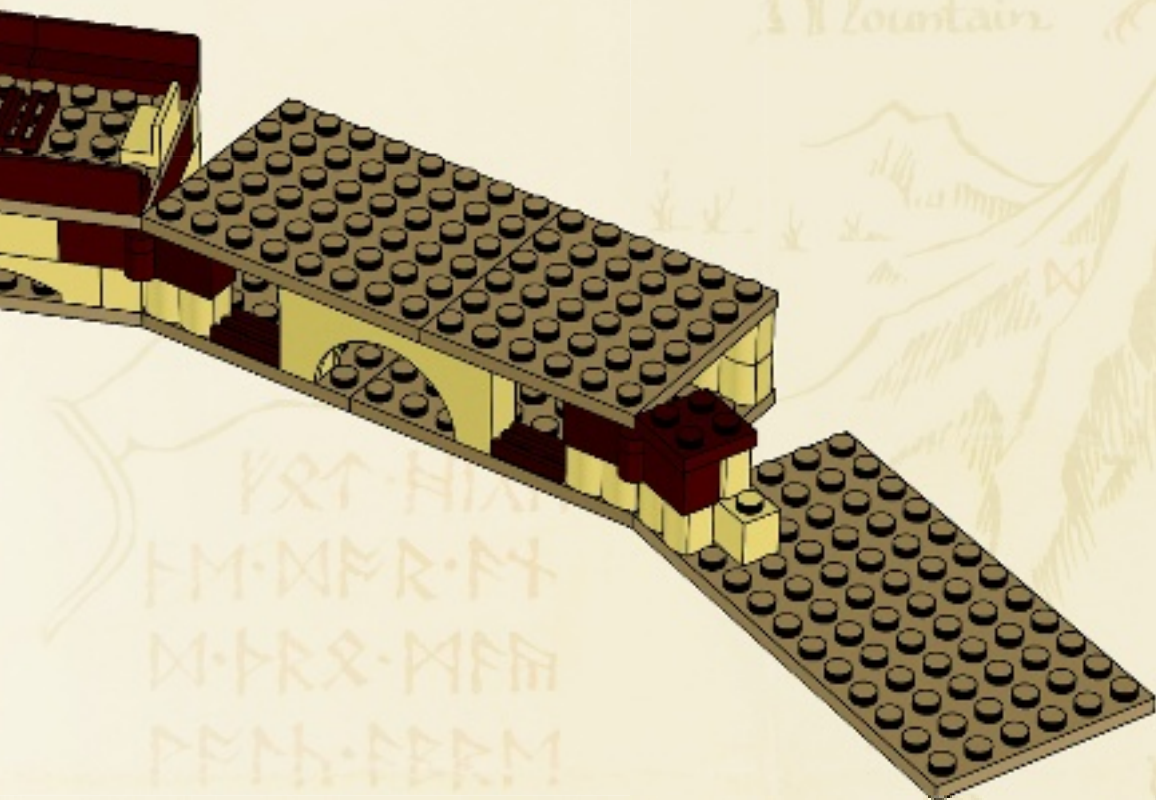

1x 2x 1x

15

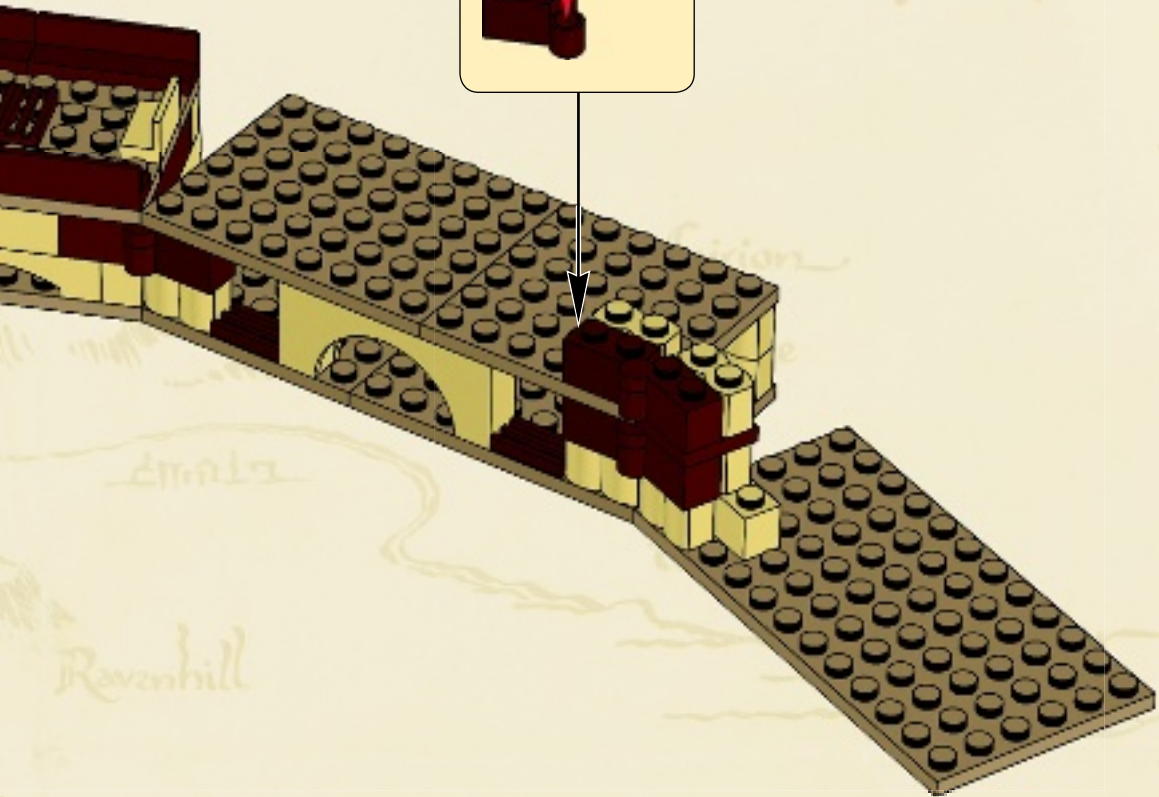
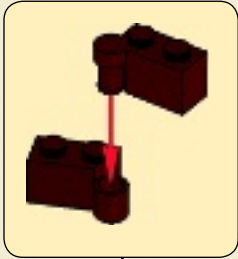



1x



1x



2x

16

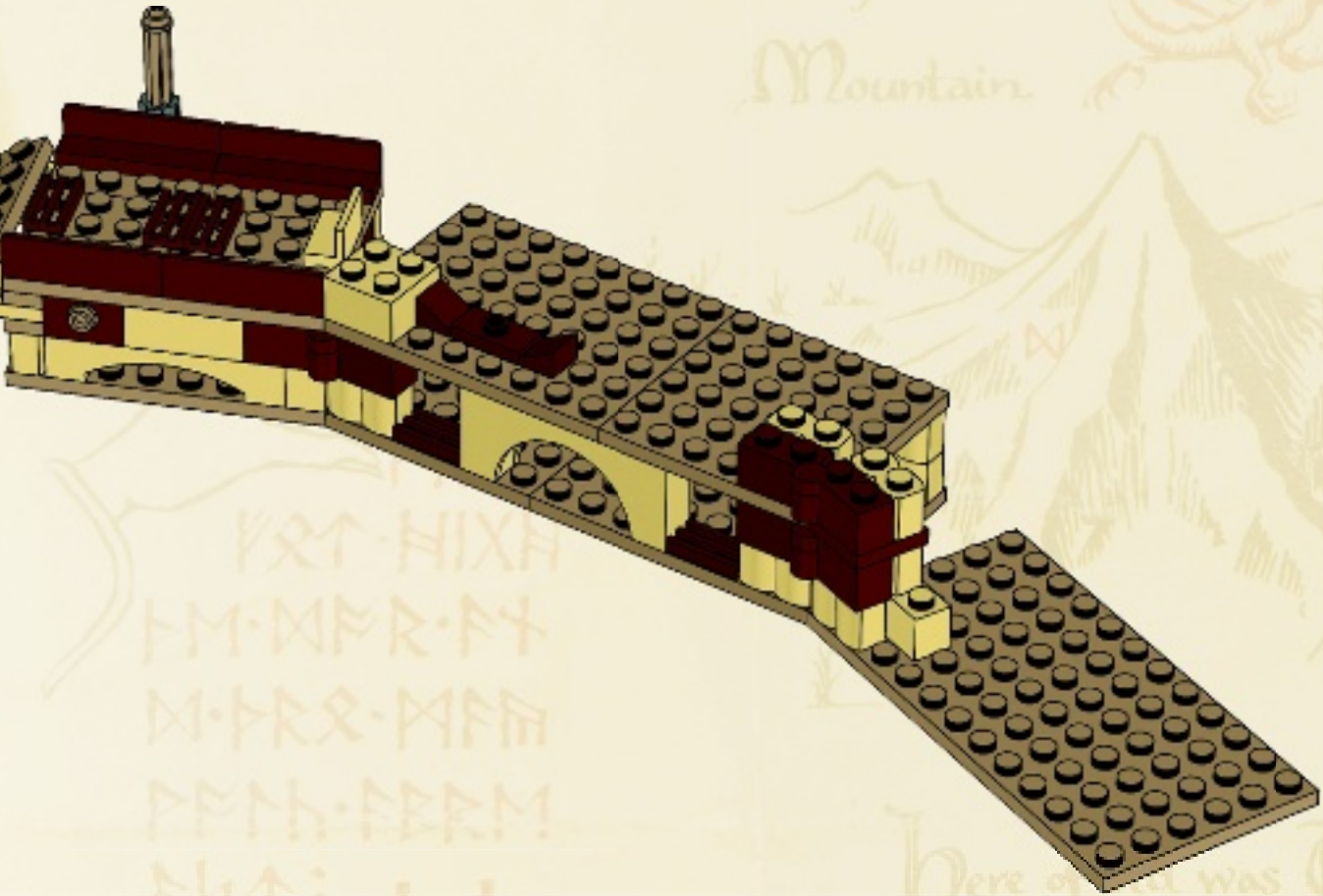



2x

17

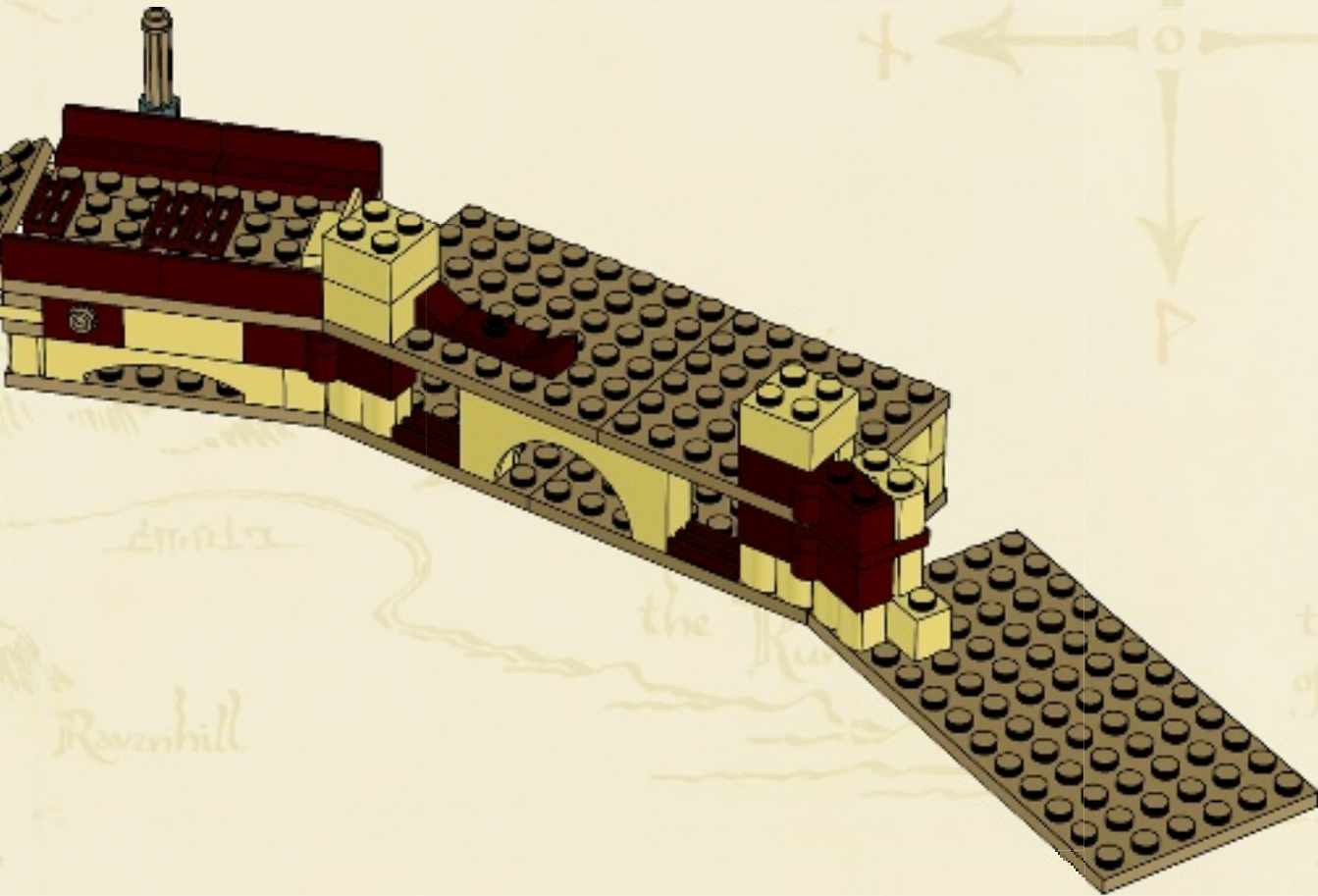



2x



2x

18

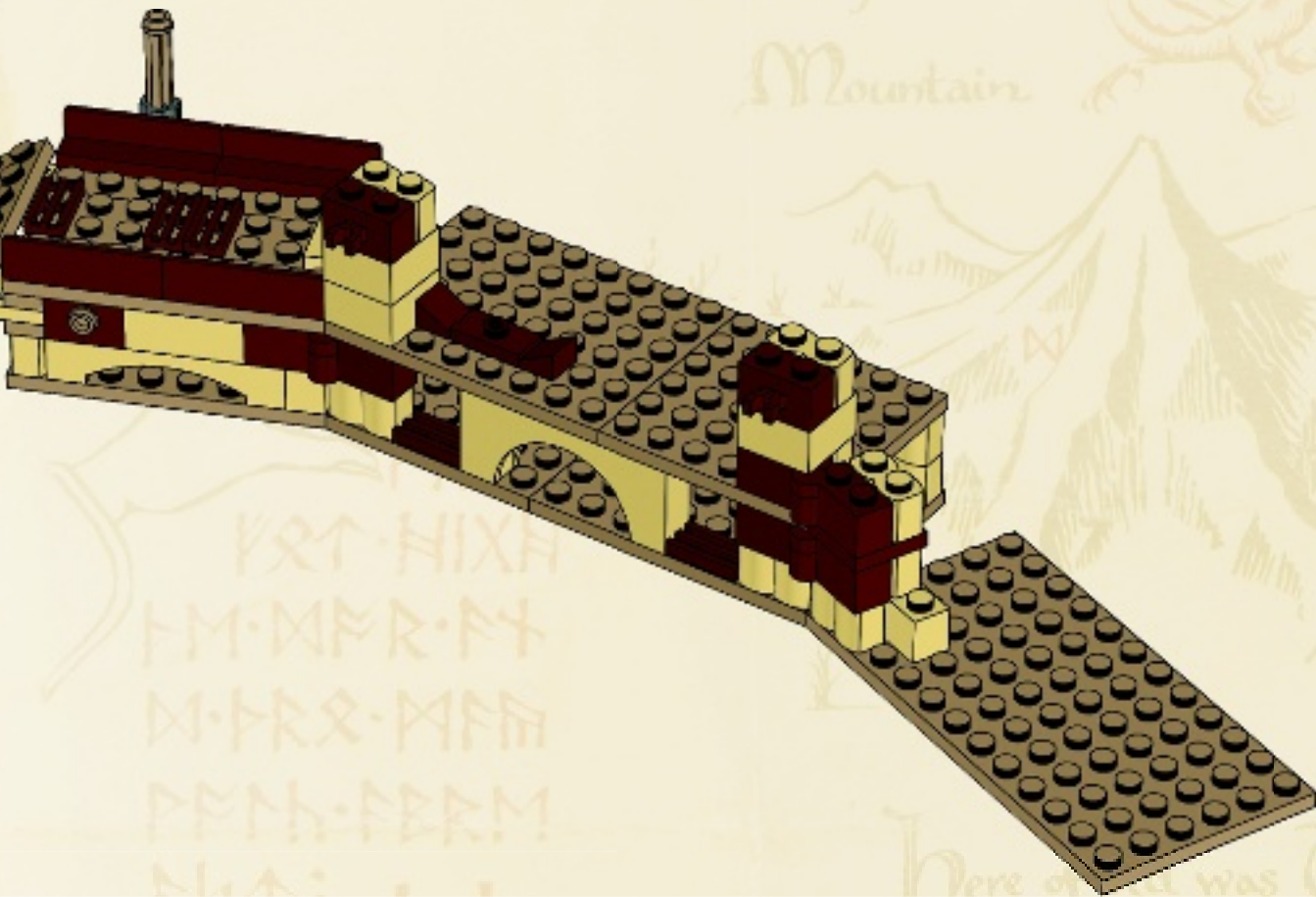



2x

19

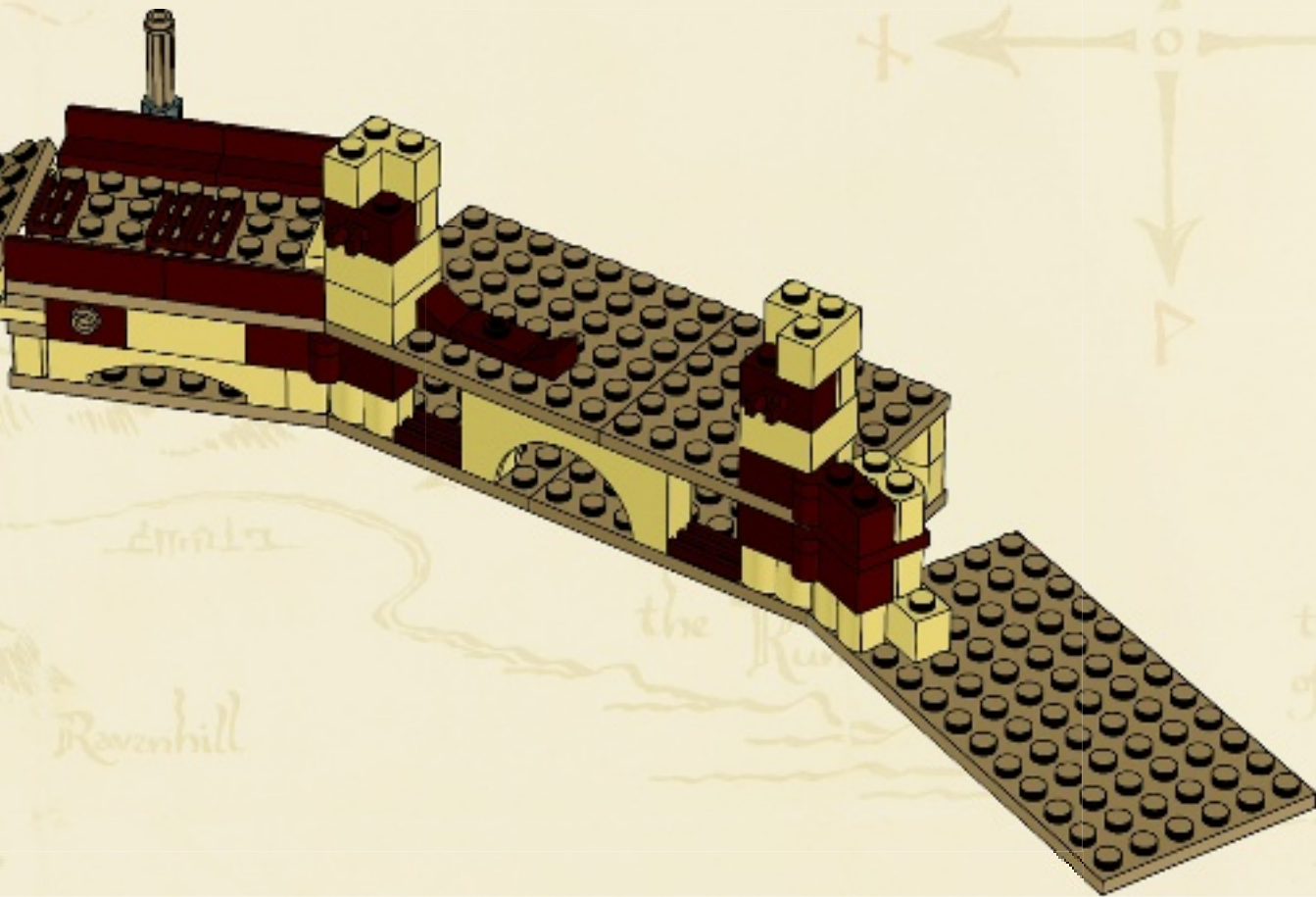

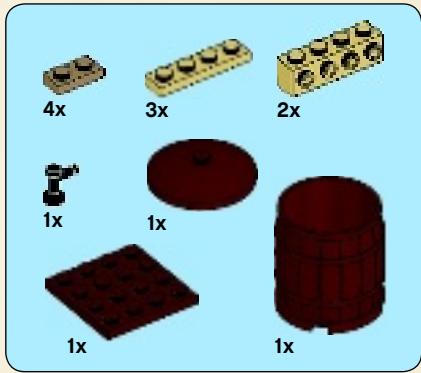

20

1

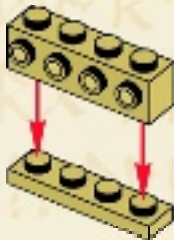

2

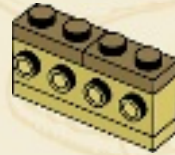

3



4

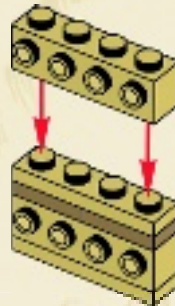

5



6



7



1



2



8

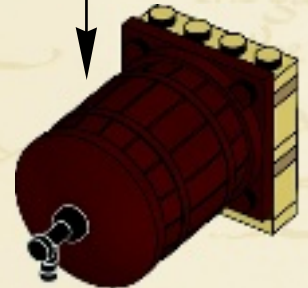

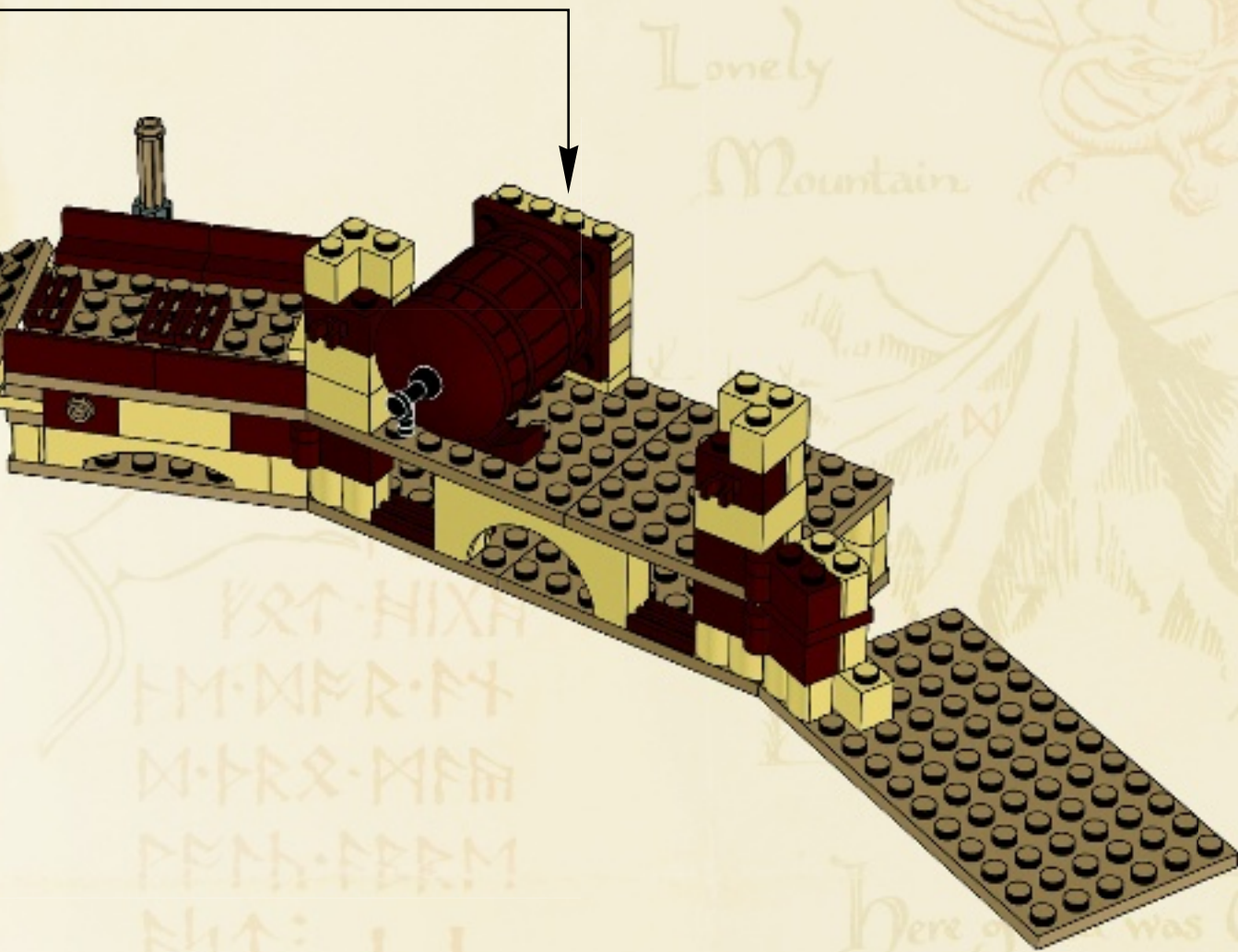

The
Lovely
Mountain

YRT·HIXA
EM·DNR·FY
D·TRQ·MFM
PEM·FERM
M↑: .P.P.

Here g... was Chror
King under the Moun

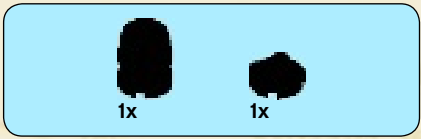

21

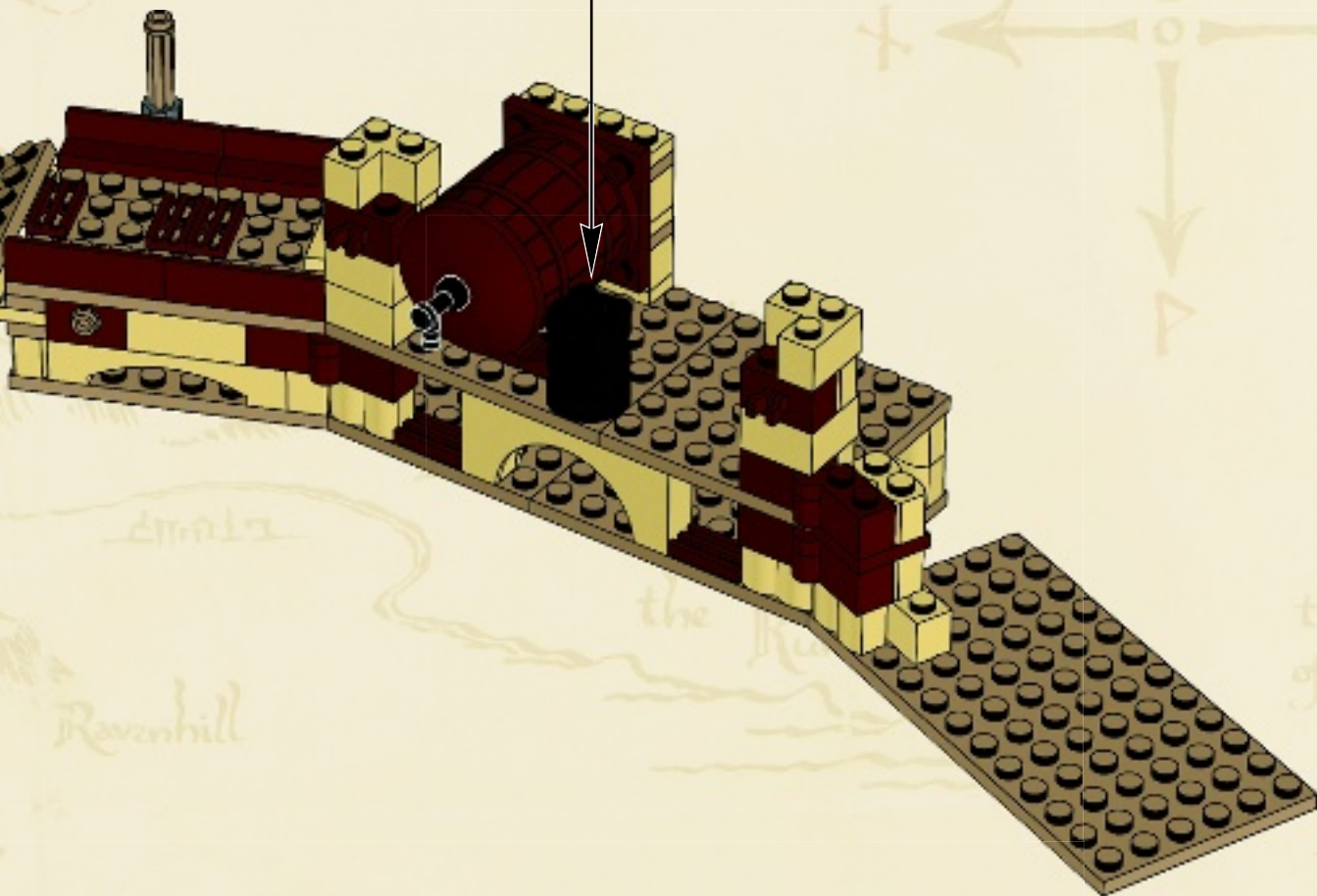
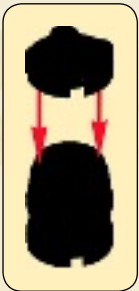

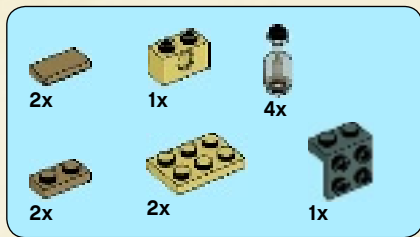

22

1



2



3

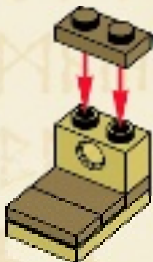

4



5



6



↑ East lie the Iron Hills
where is Dair

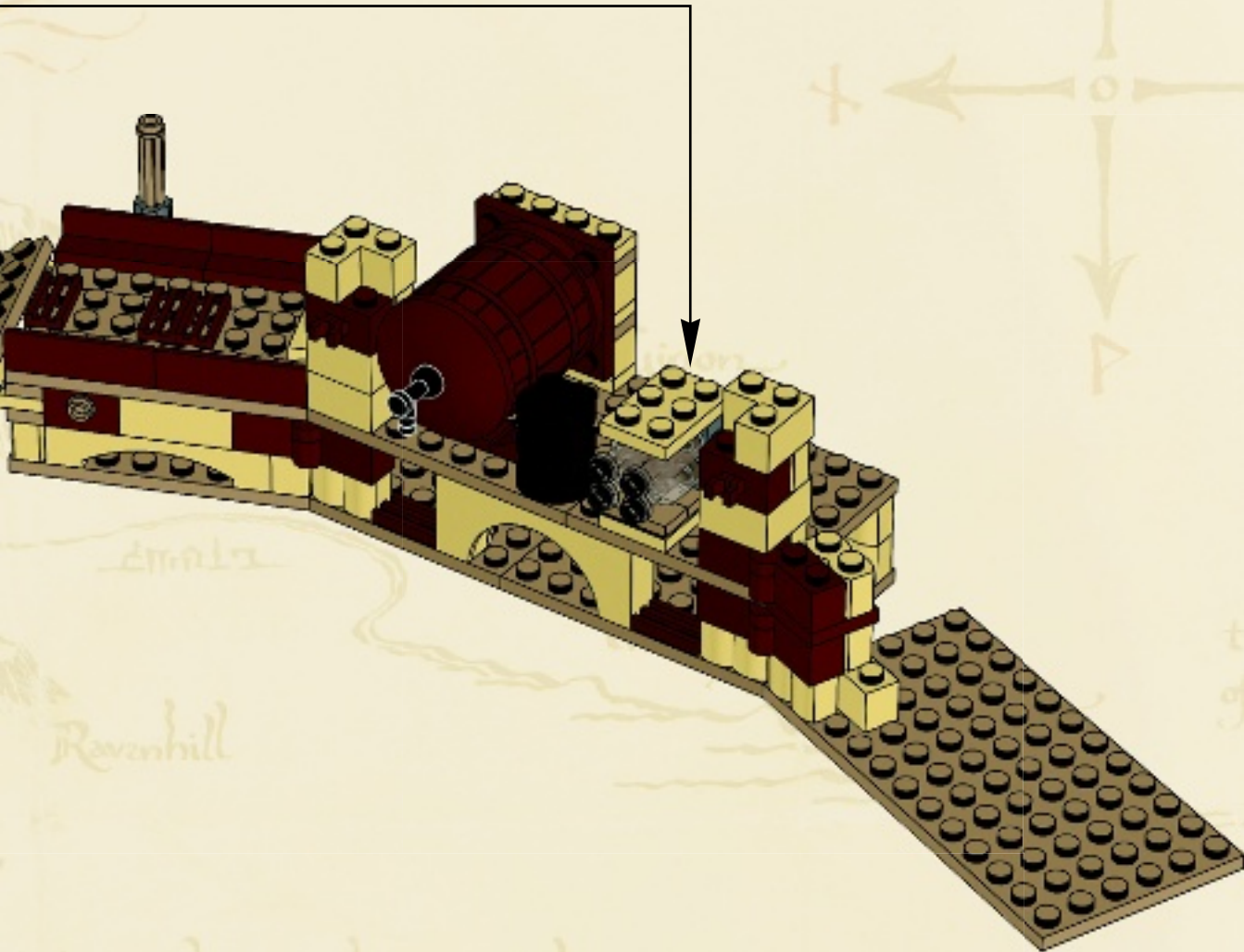

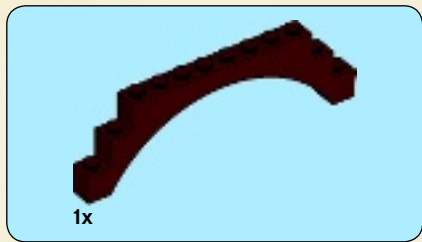

23

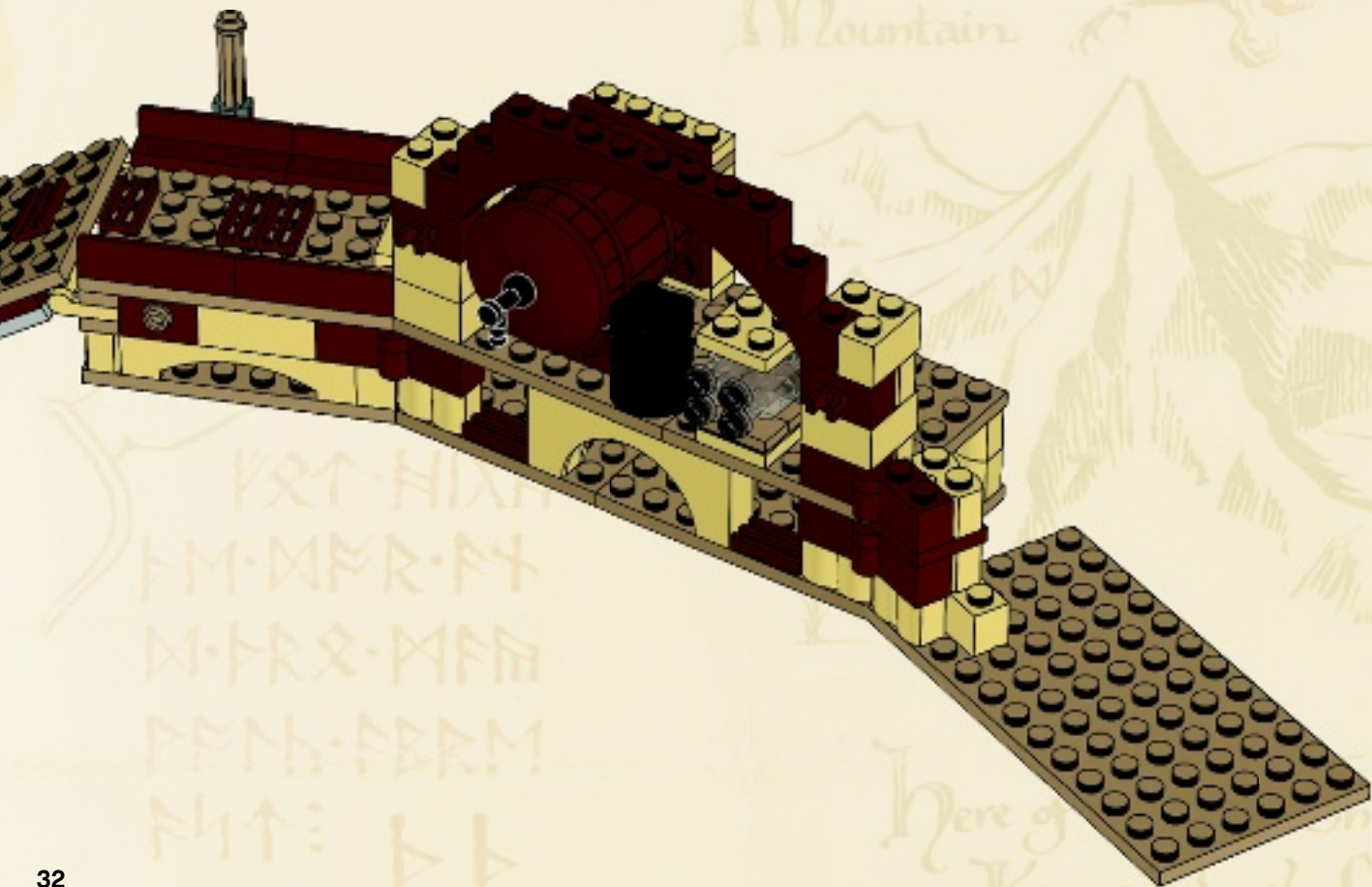



2x

24

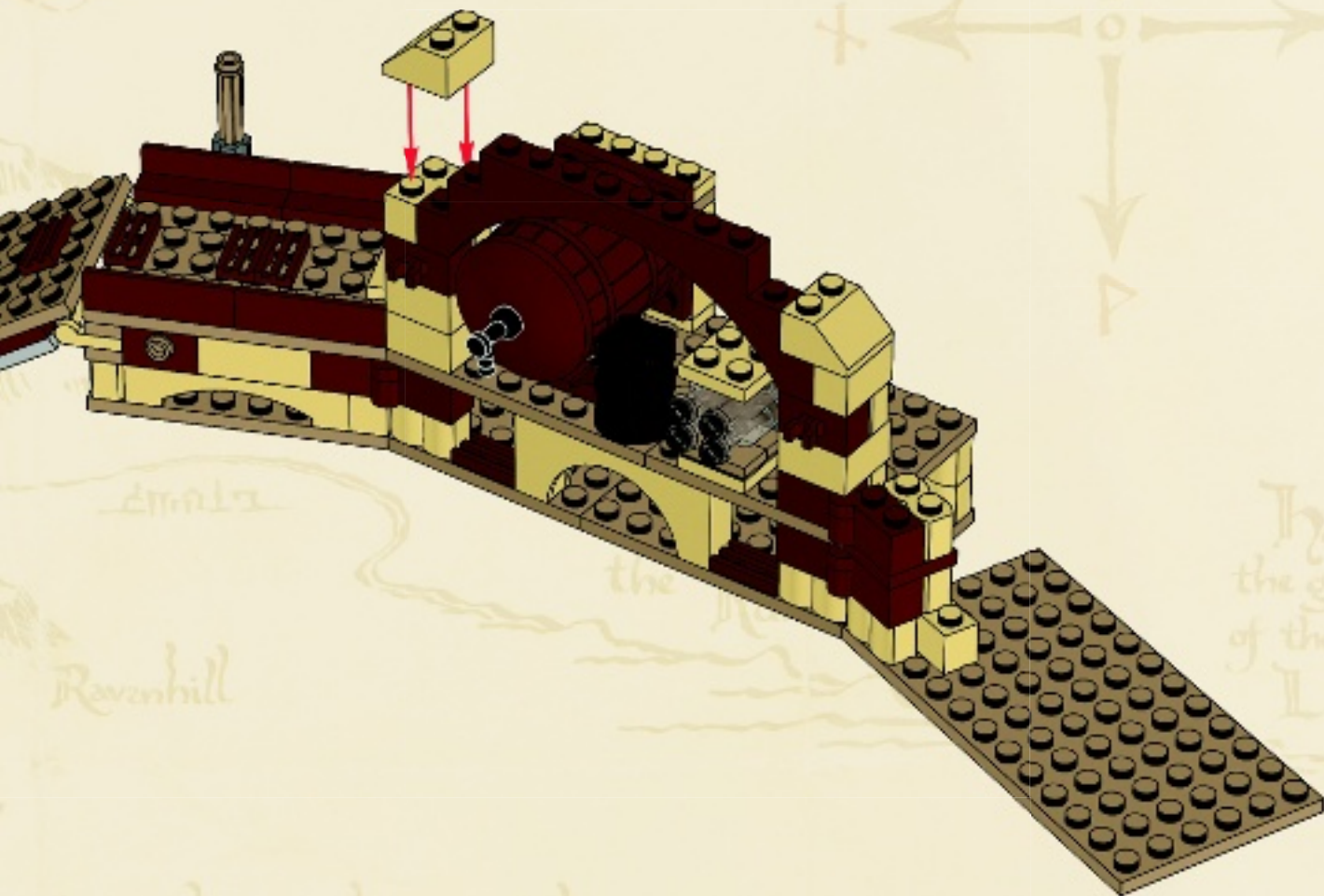



4x

25

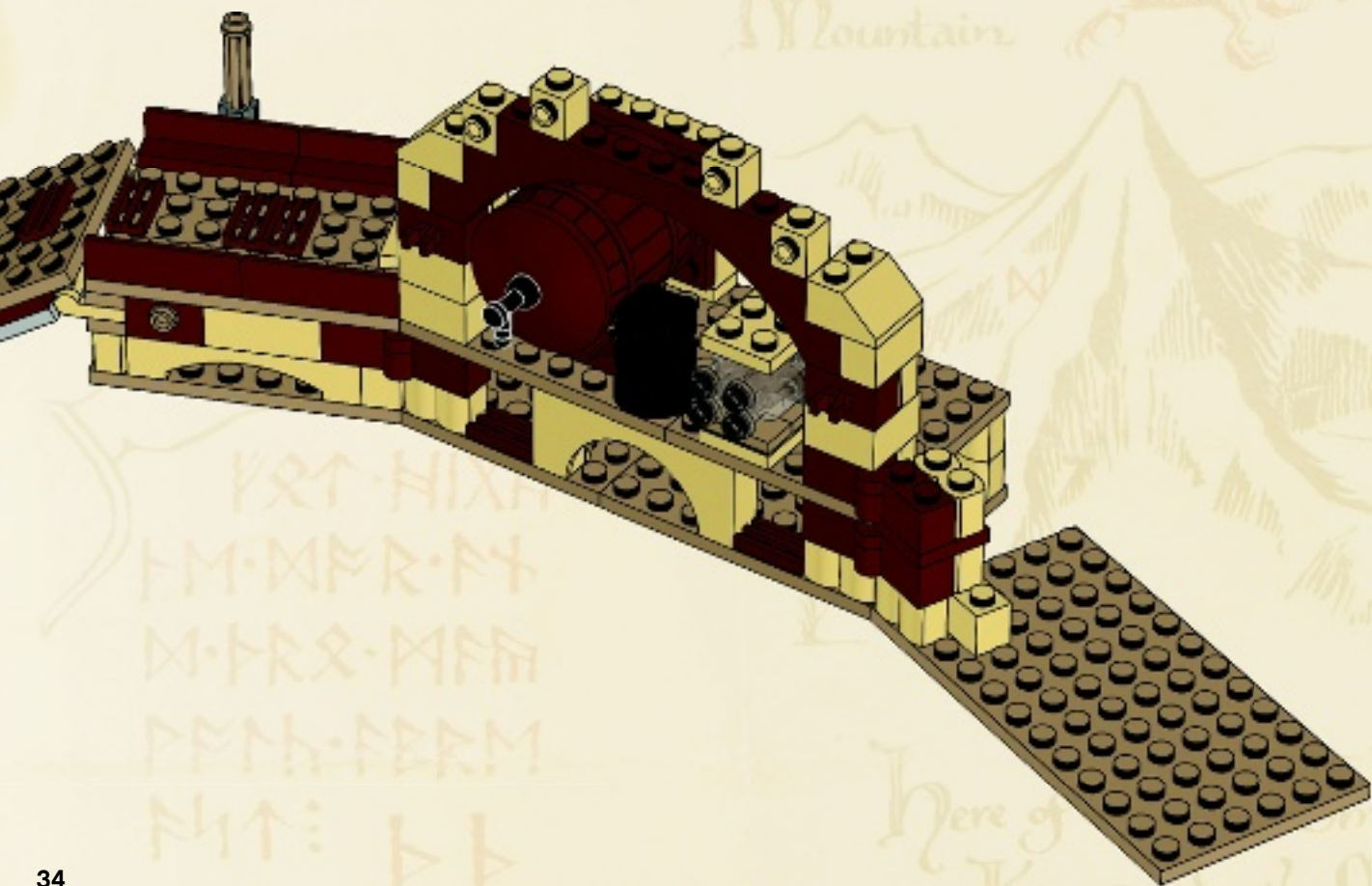

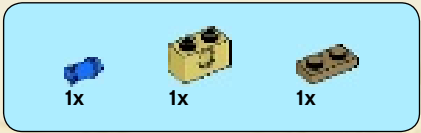

26

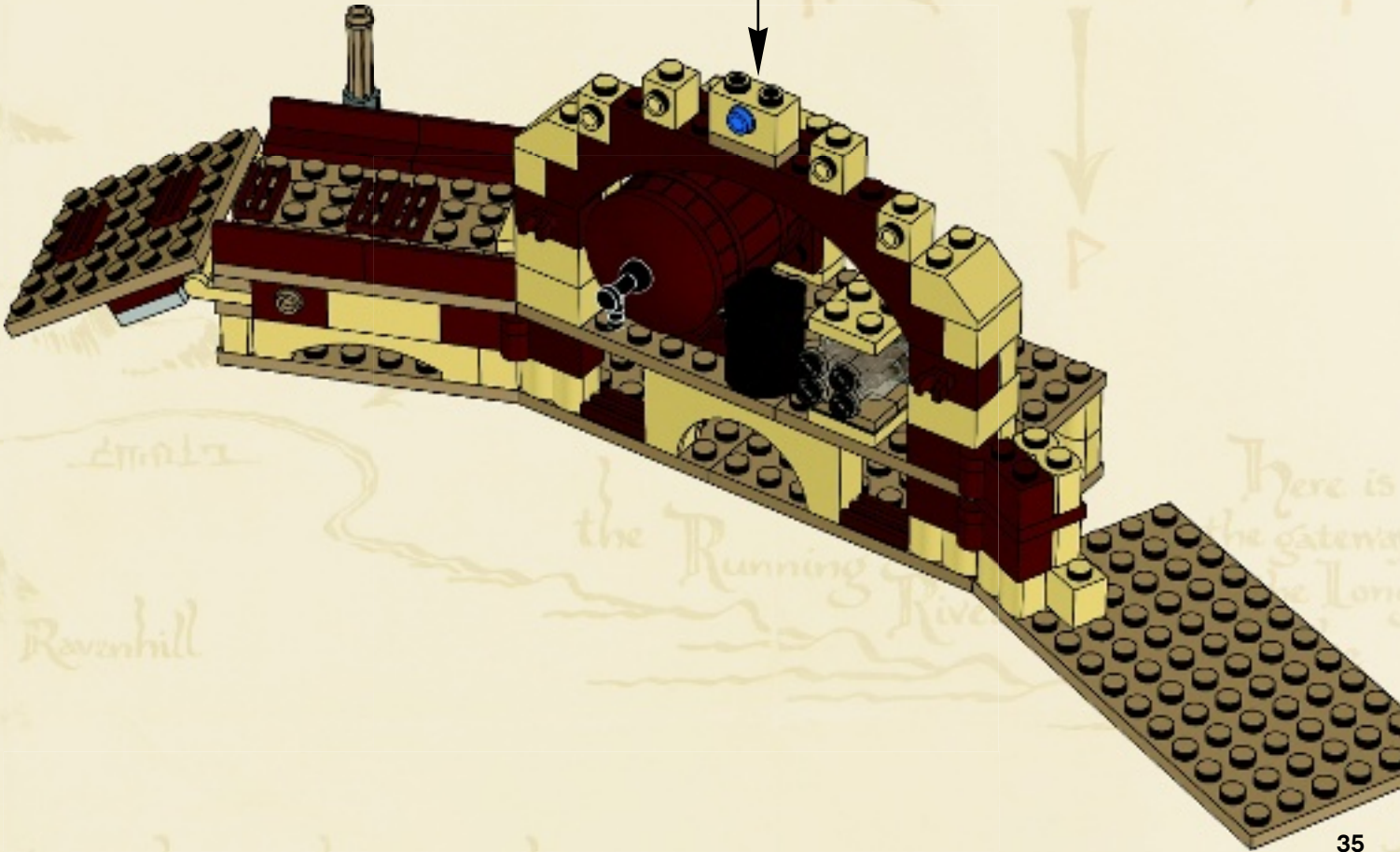
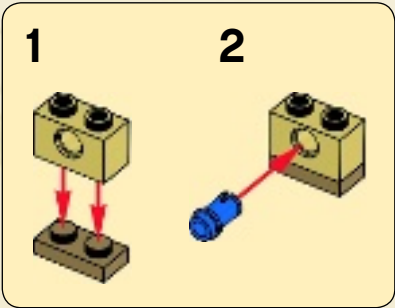

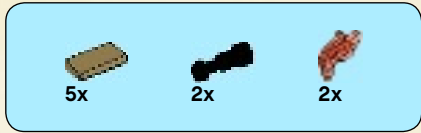

27

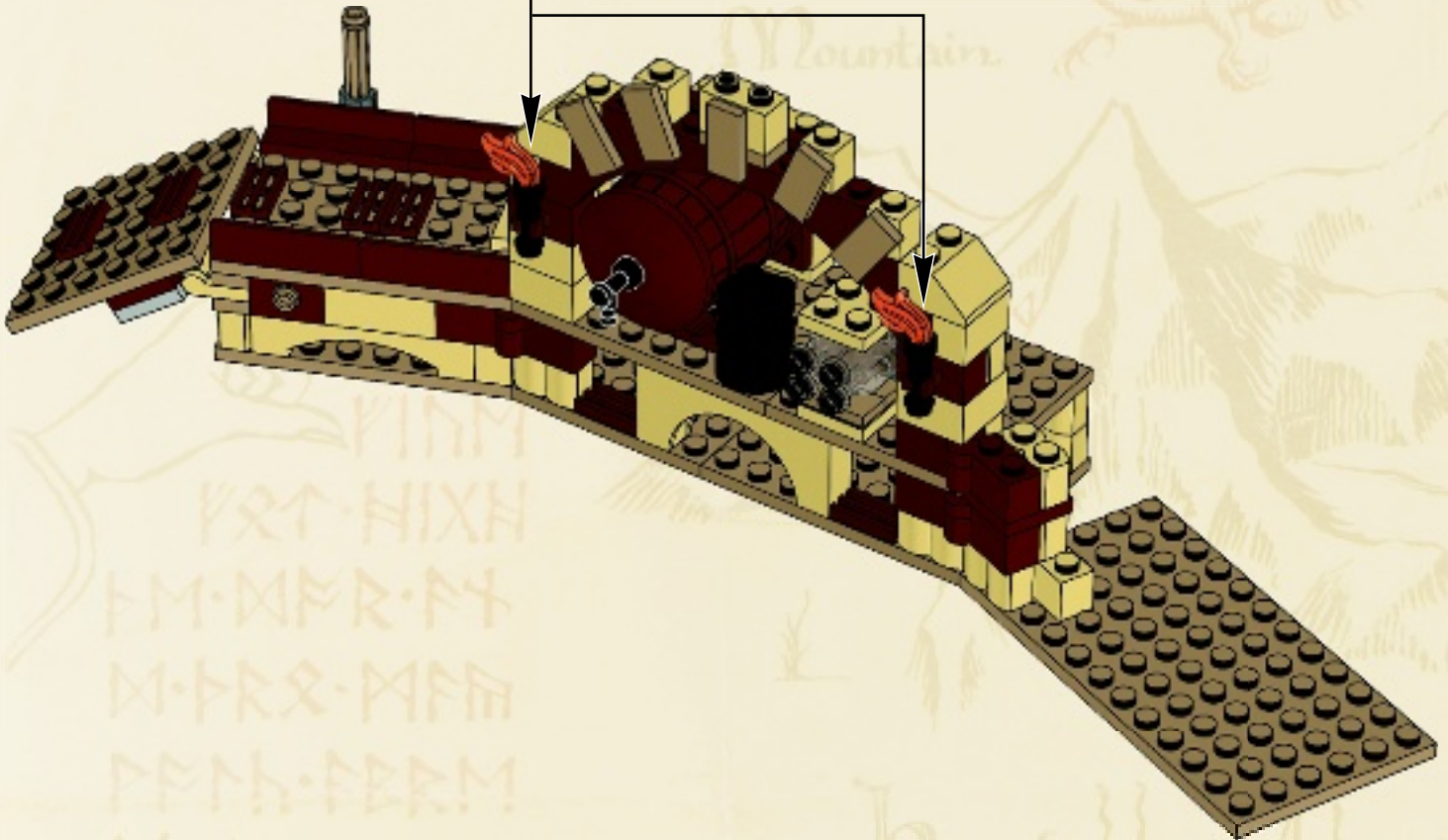
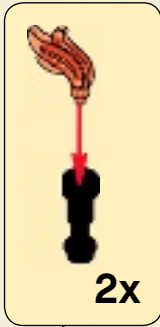



28

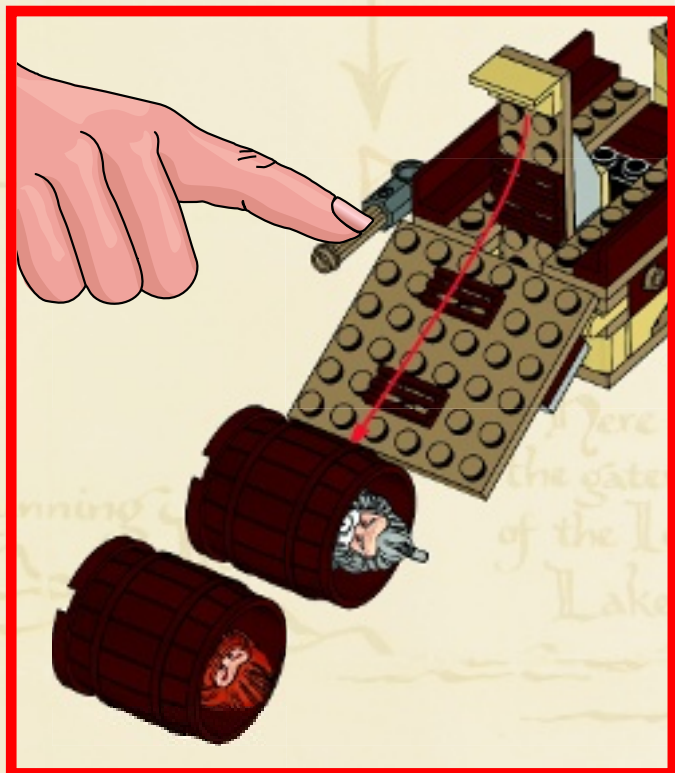
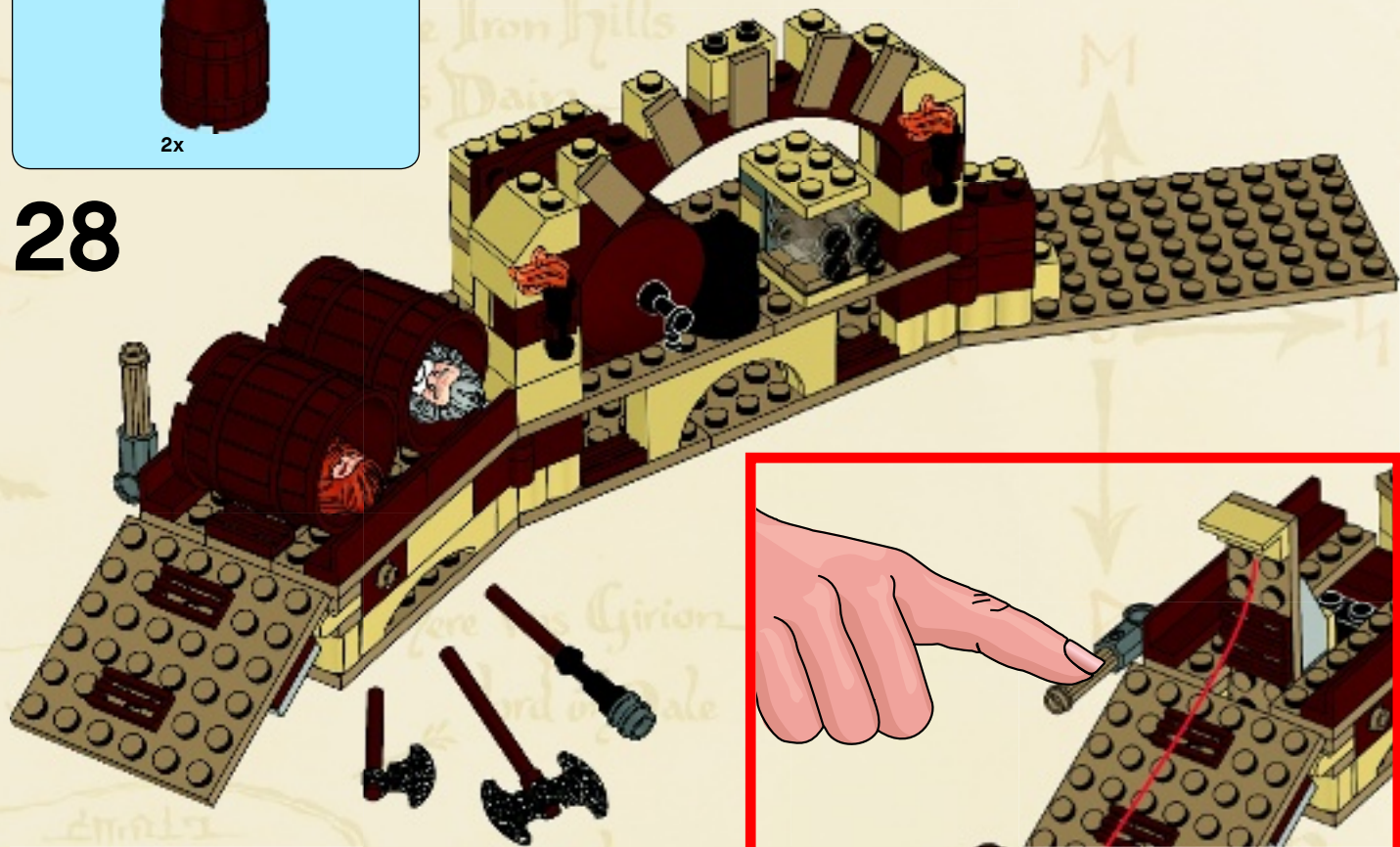

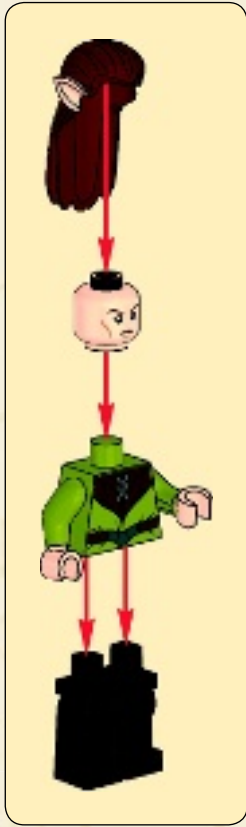

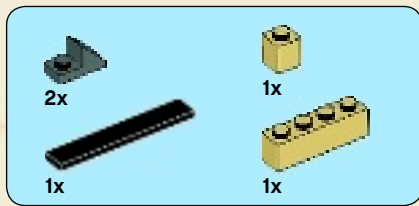

29

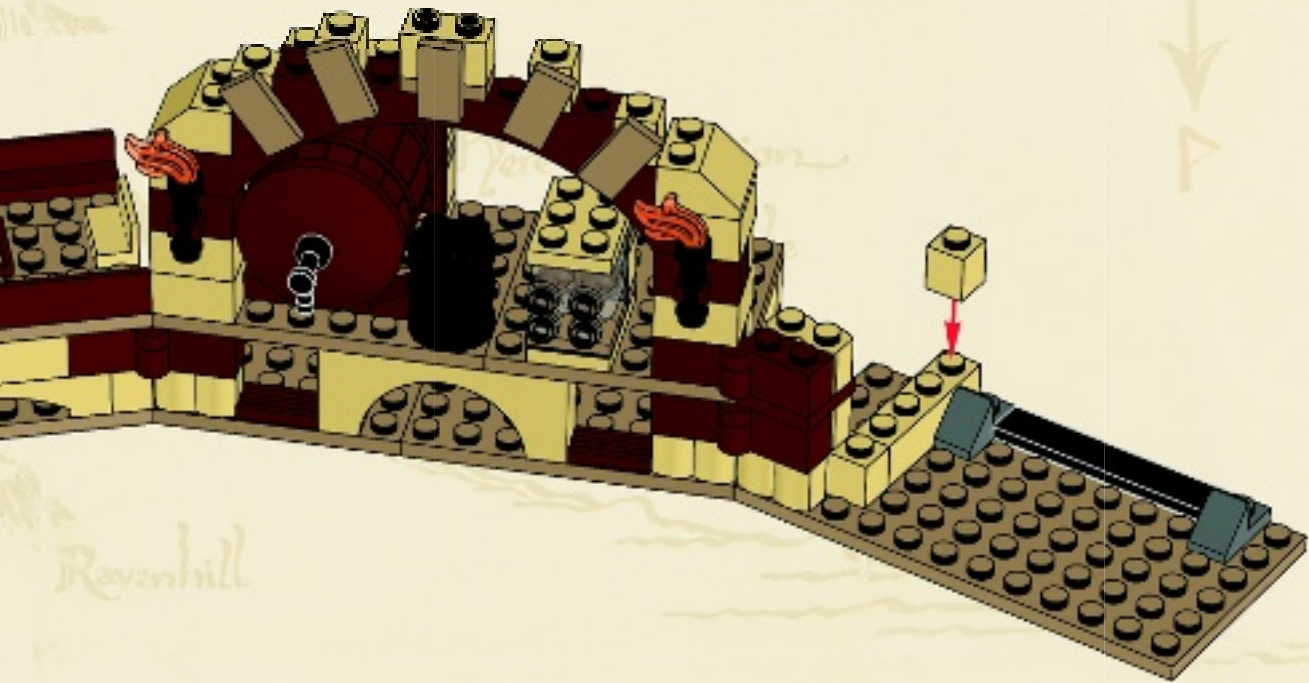

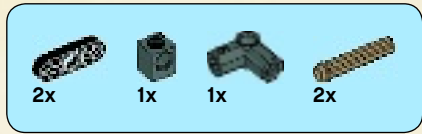

30

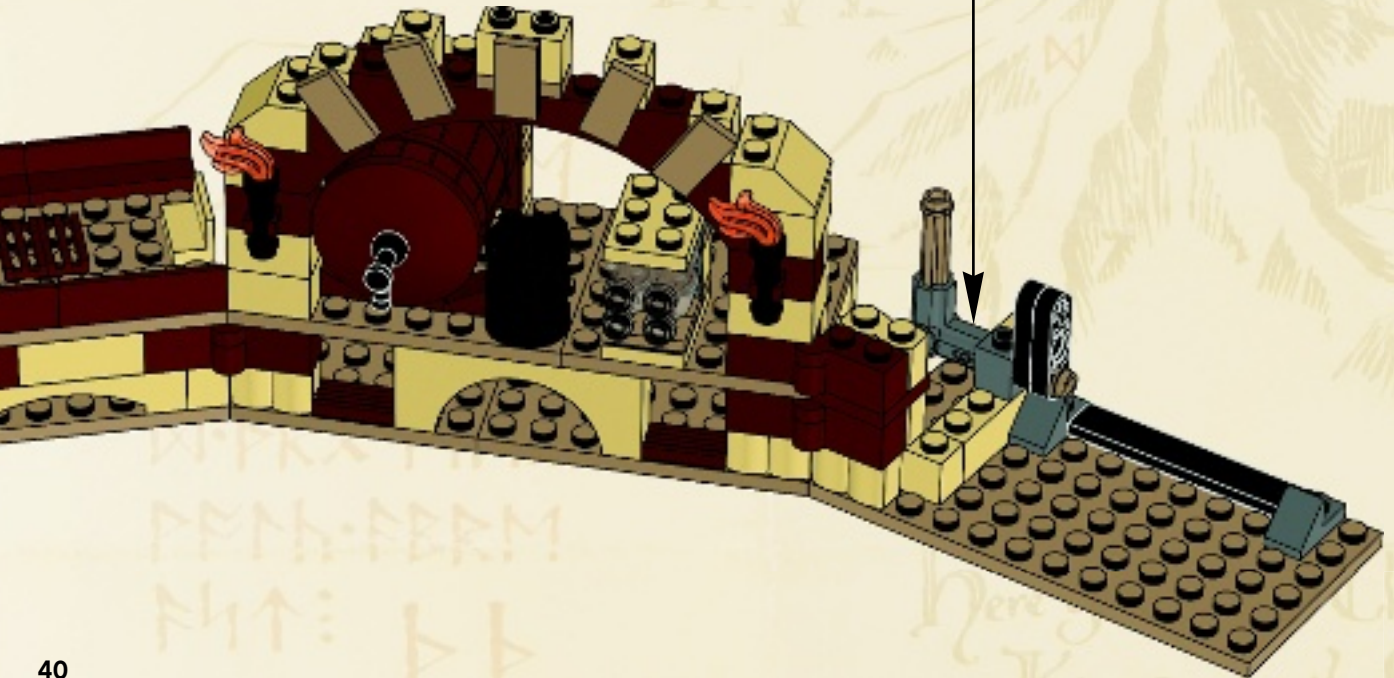
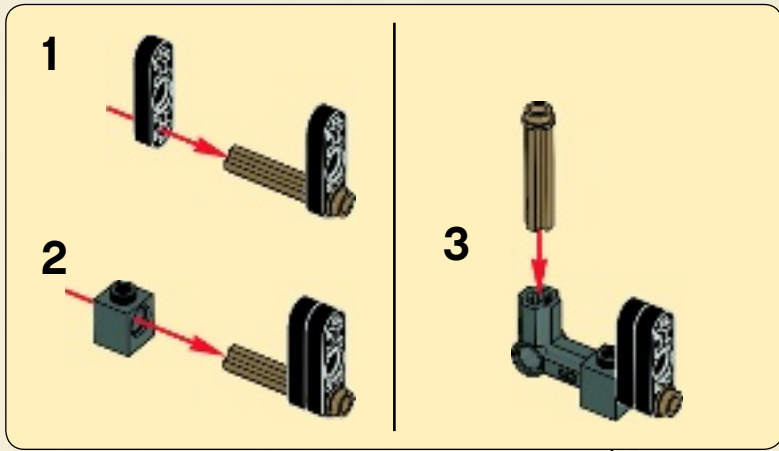

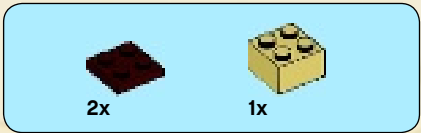

31

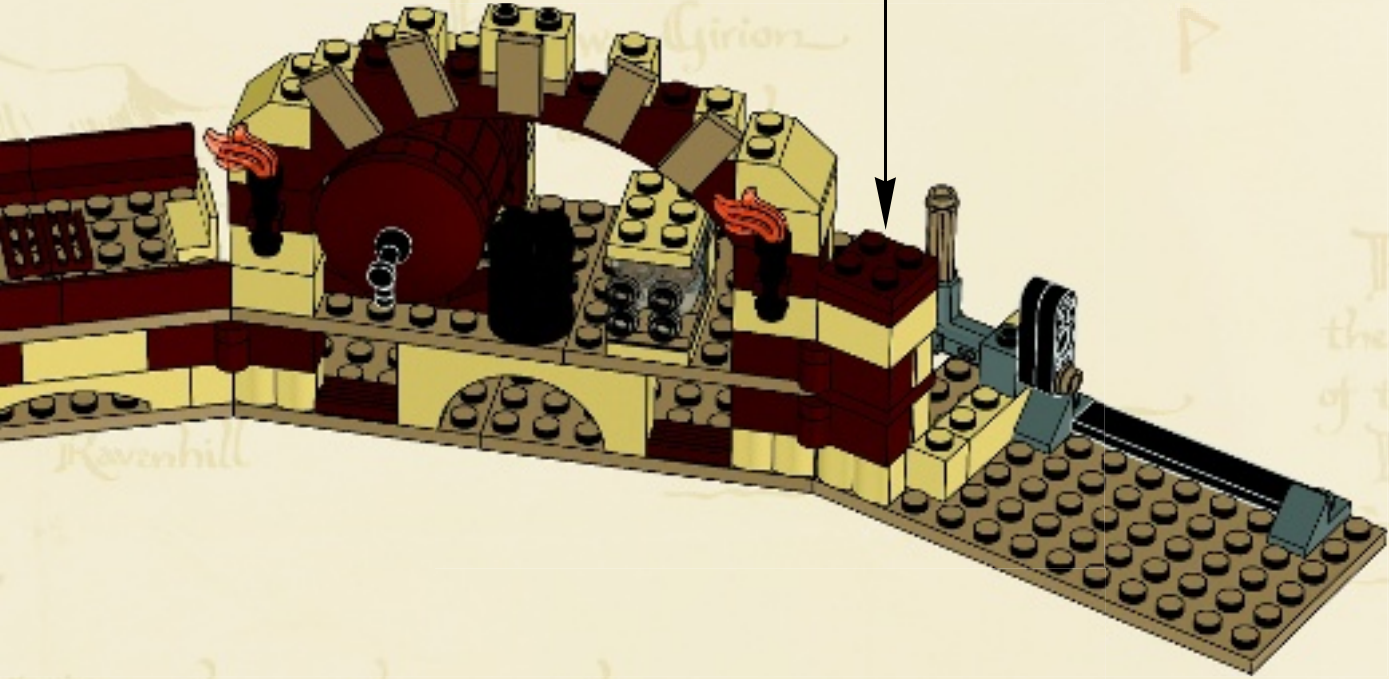
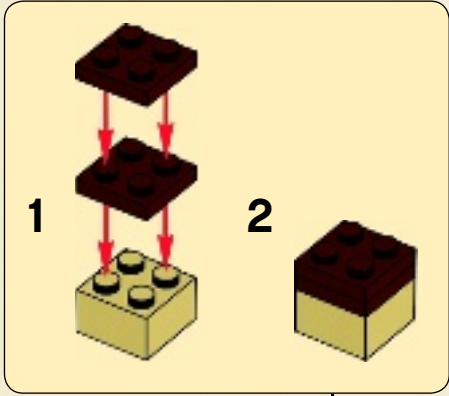



1x

32

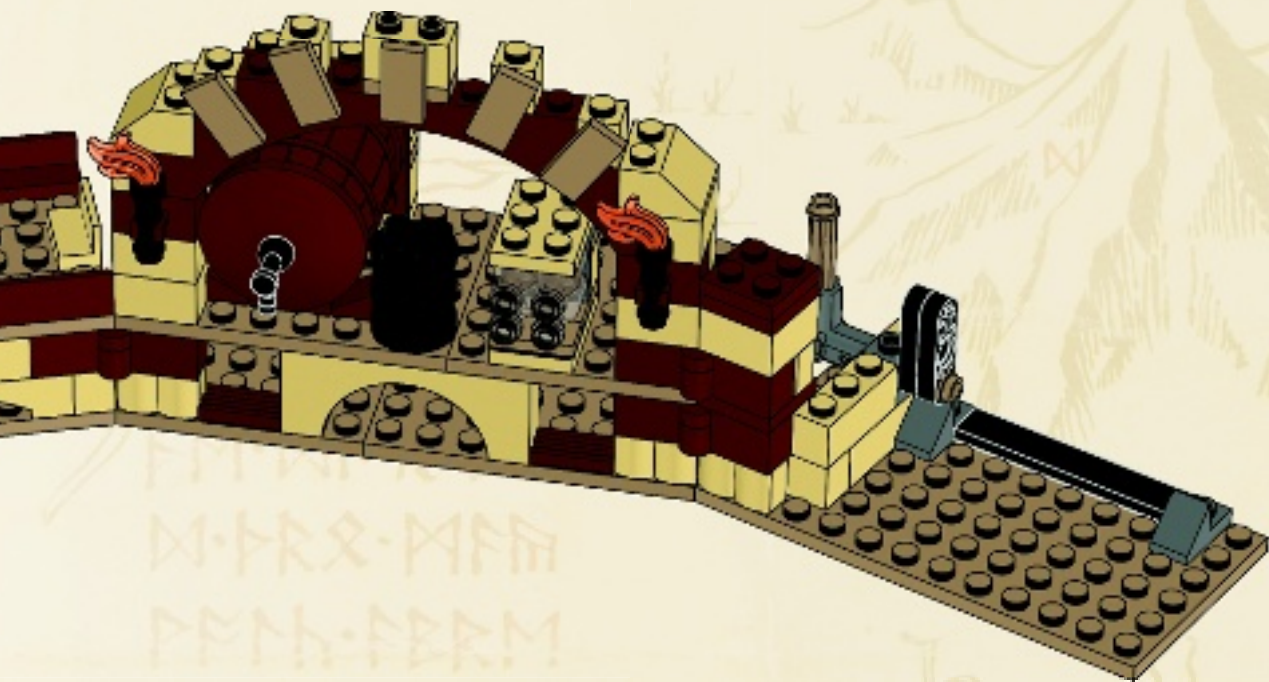

The
Lonely
Mountain

Here of old was Thrór
King under the Moun



3x

33

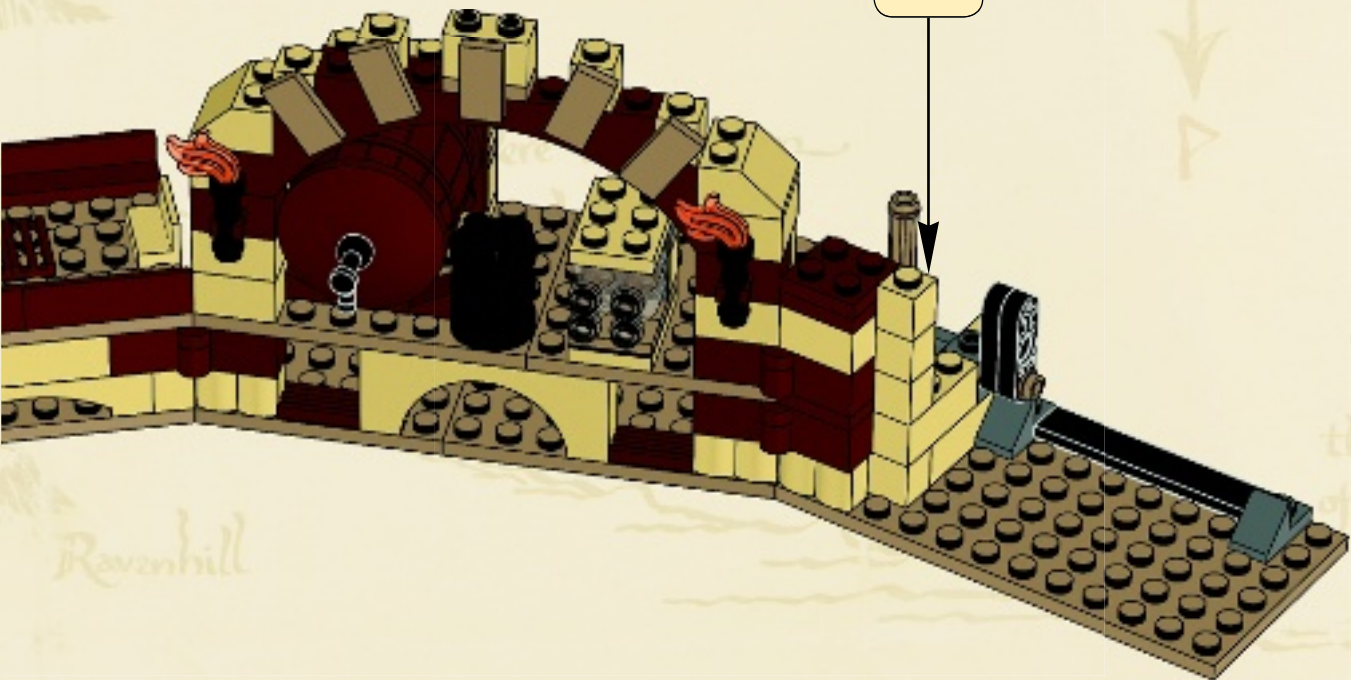
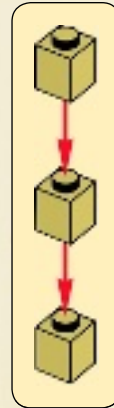

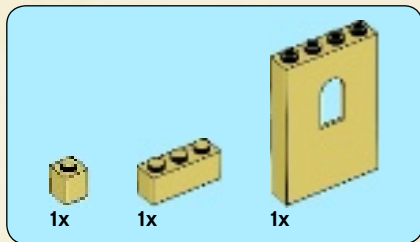

34

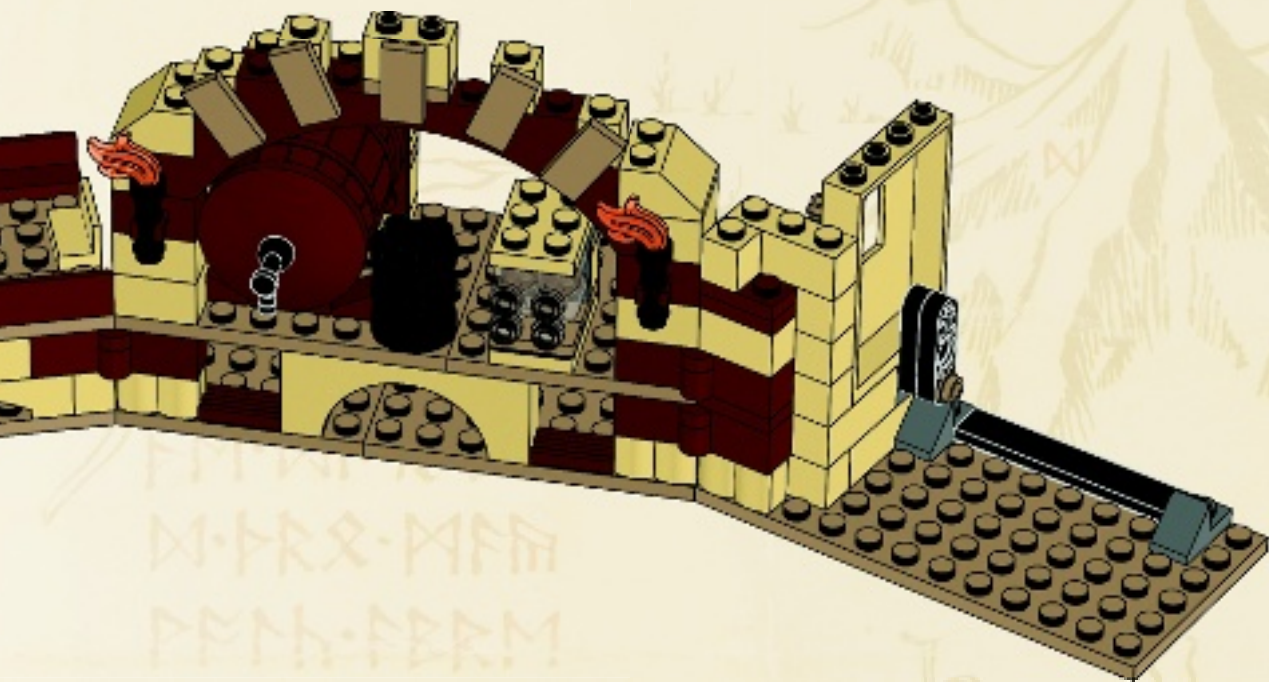



35

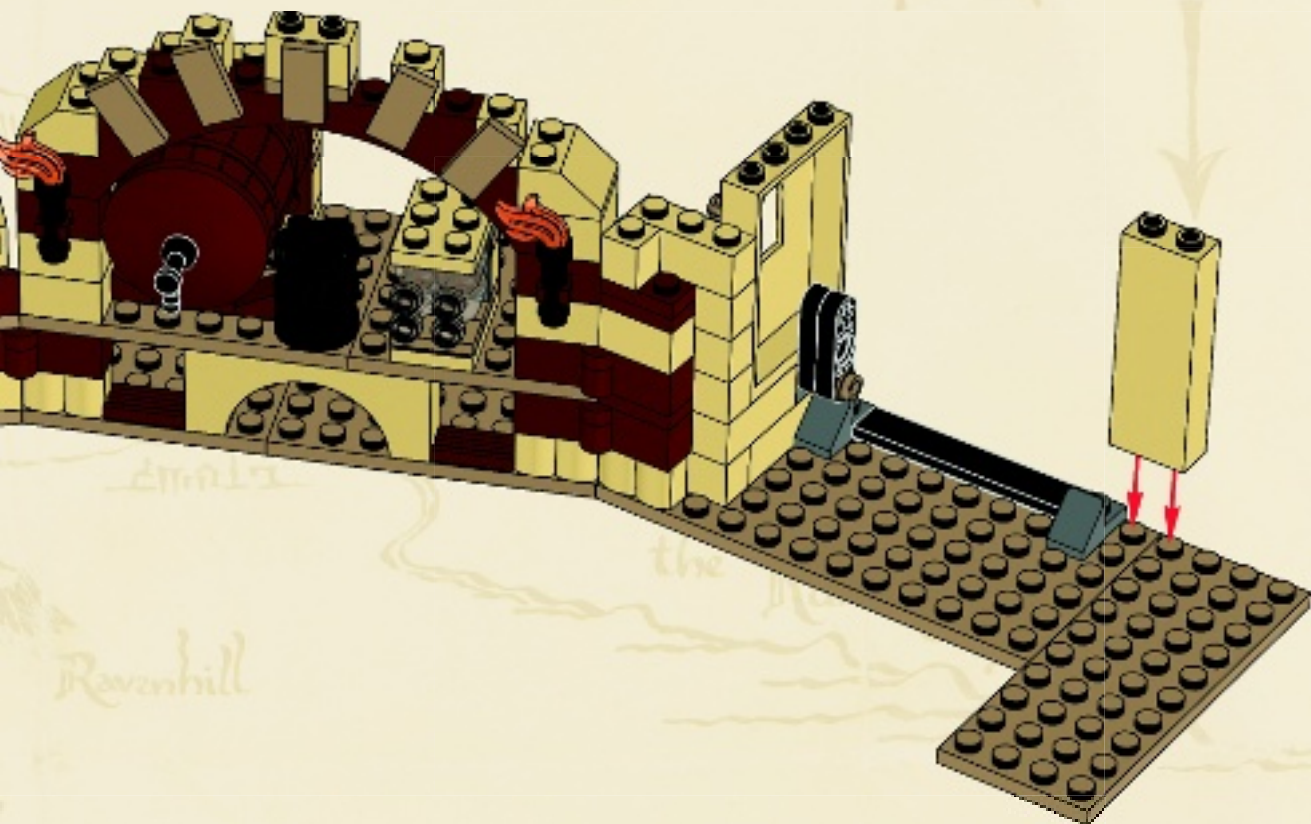



1x



1x

36

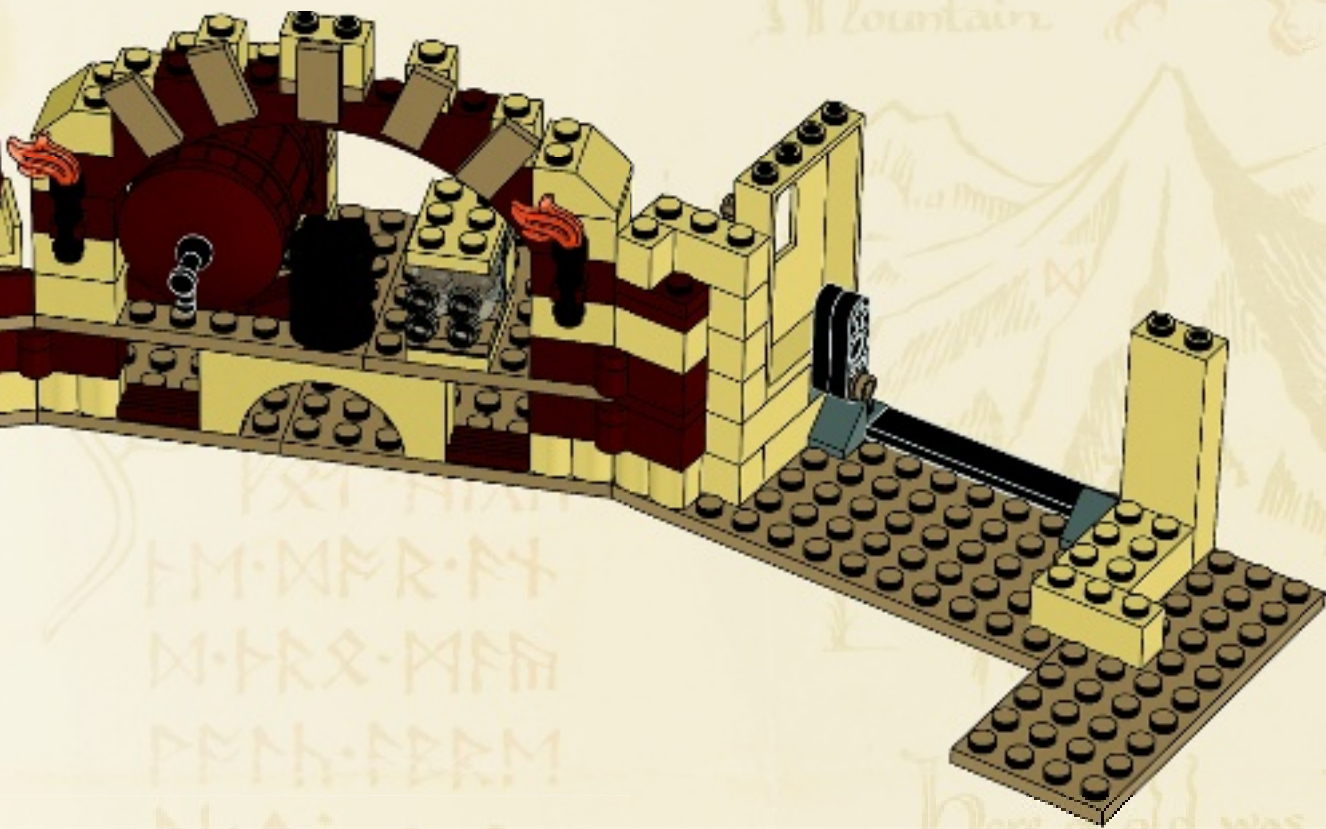

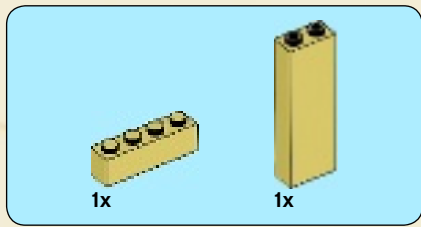

37

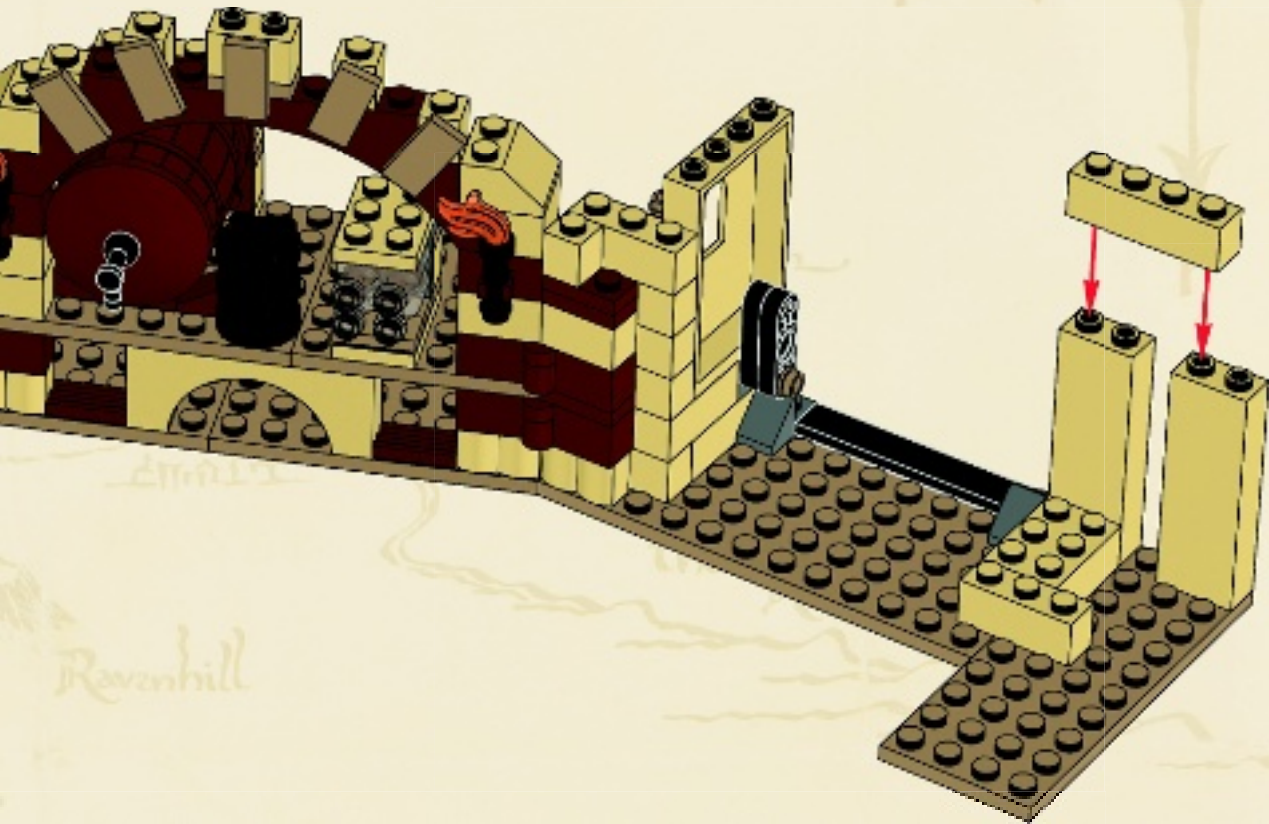

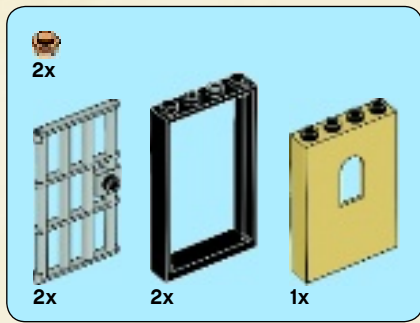

38

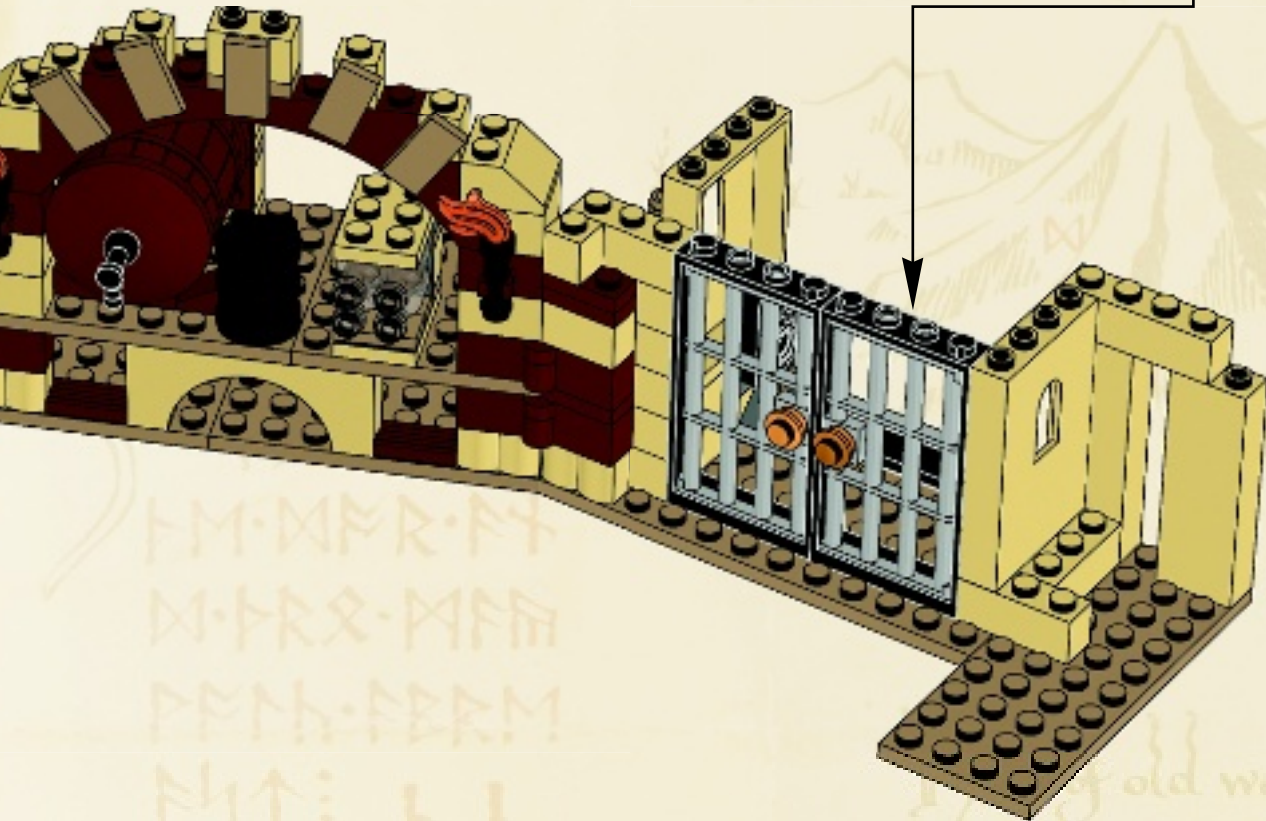
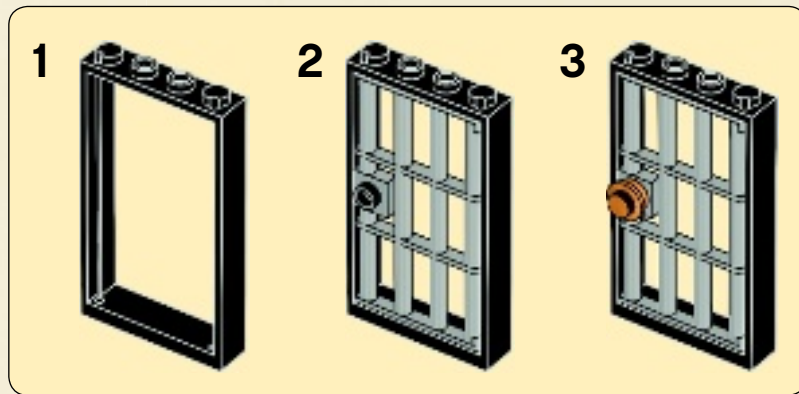

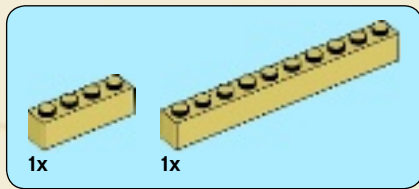

39

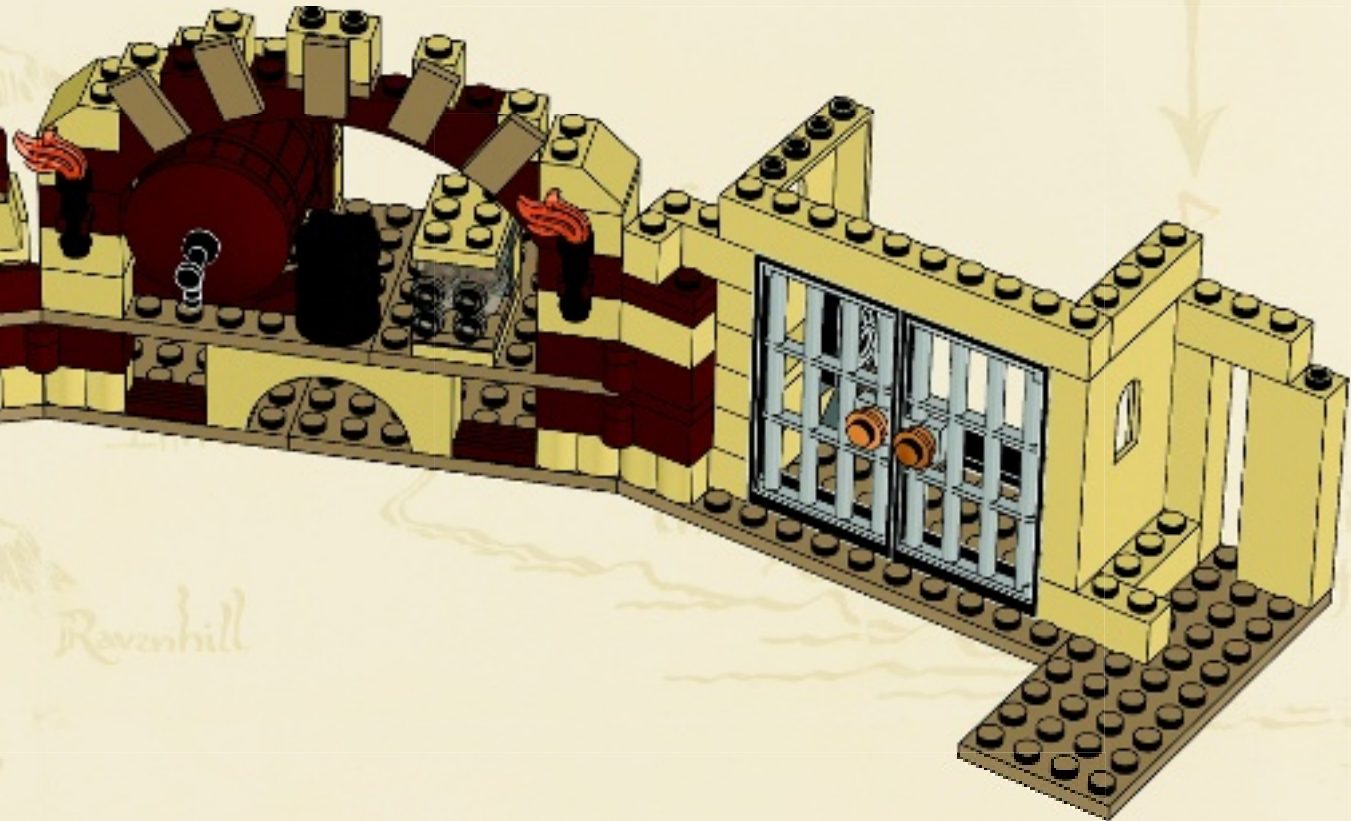

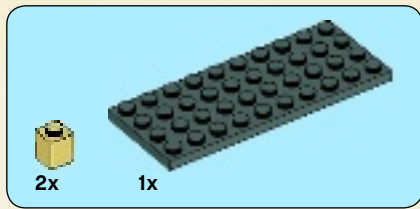

40

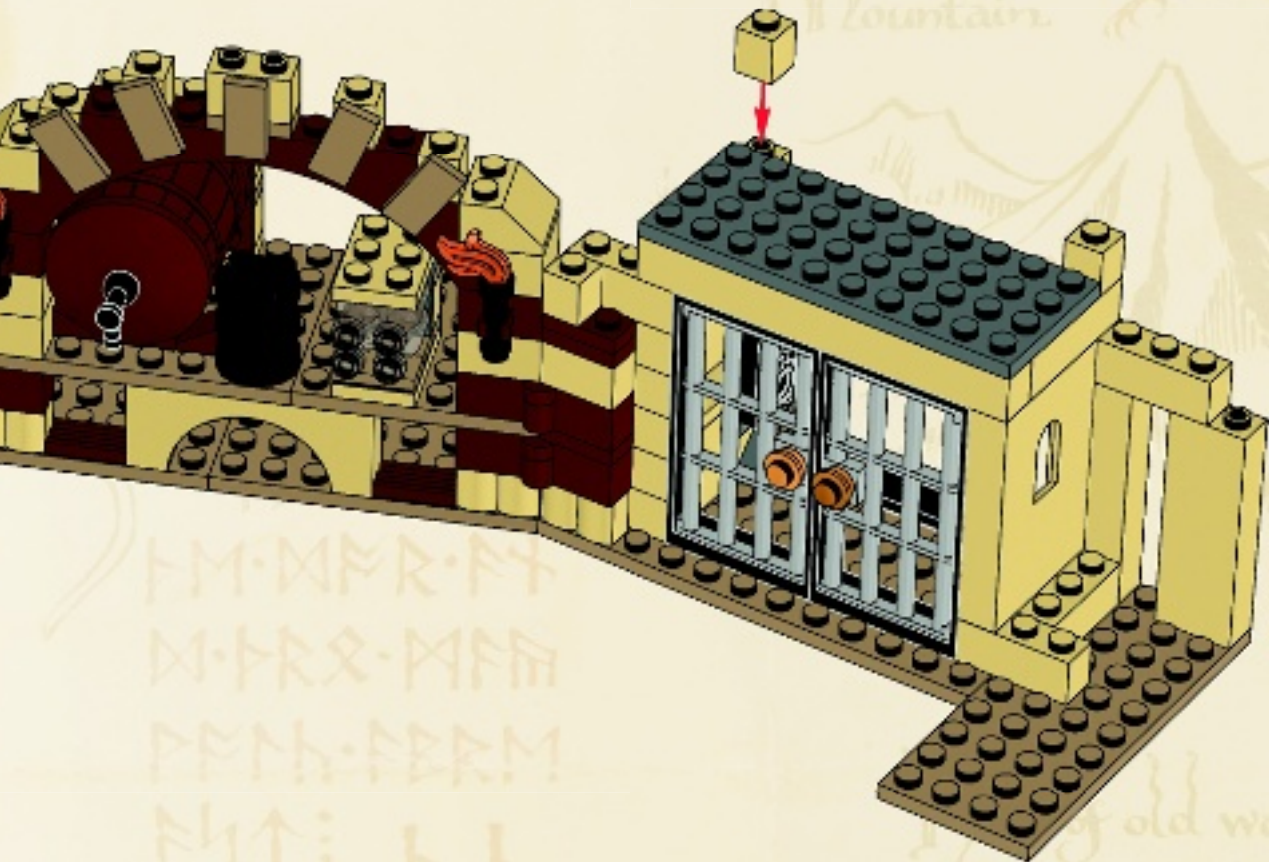



41

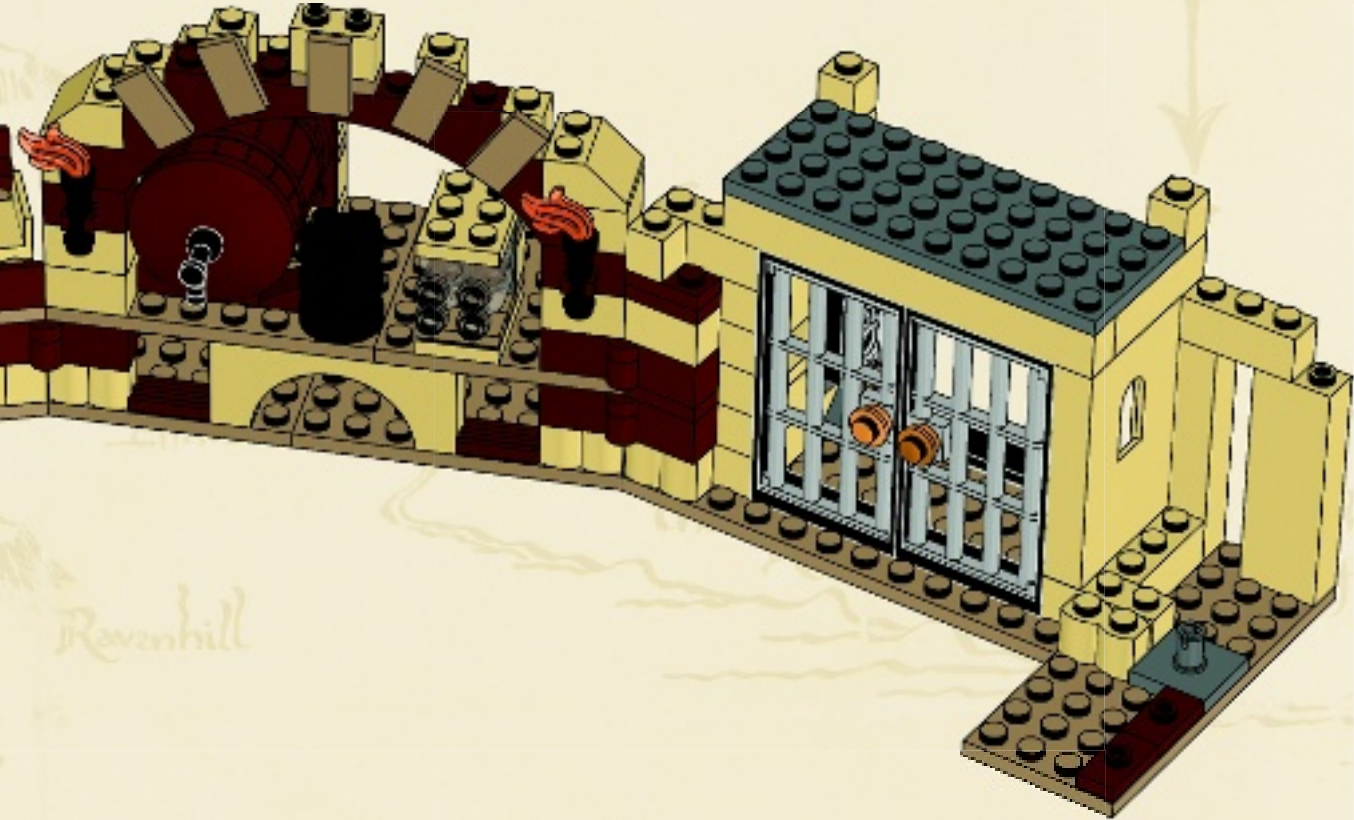

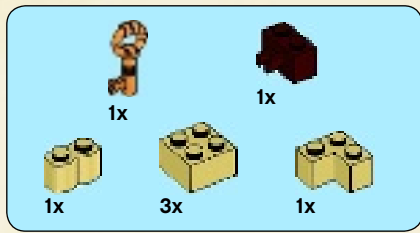

42

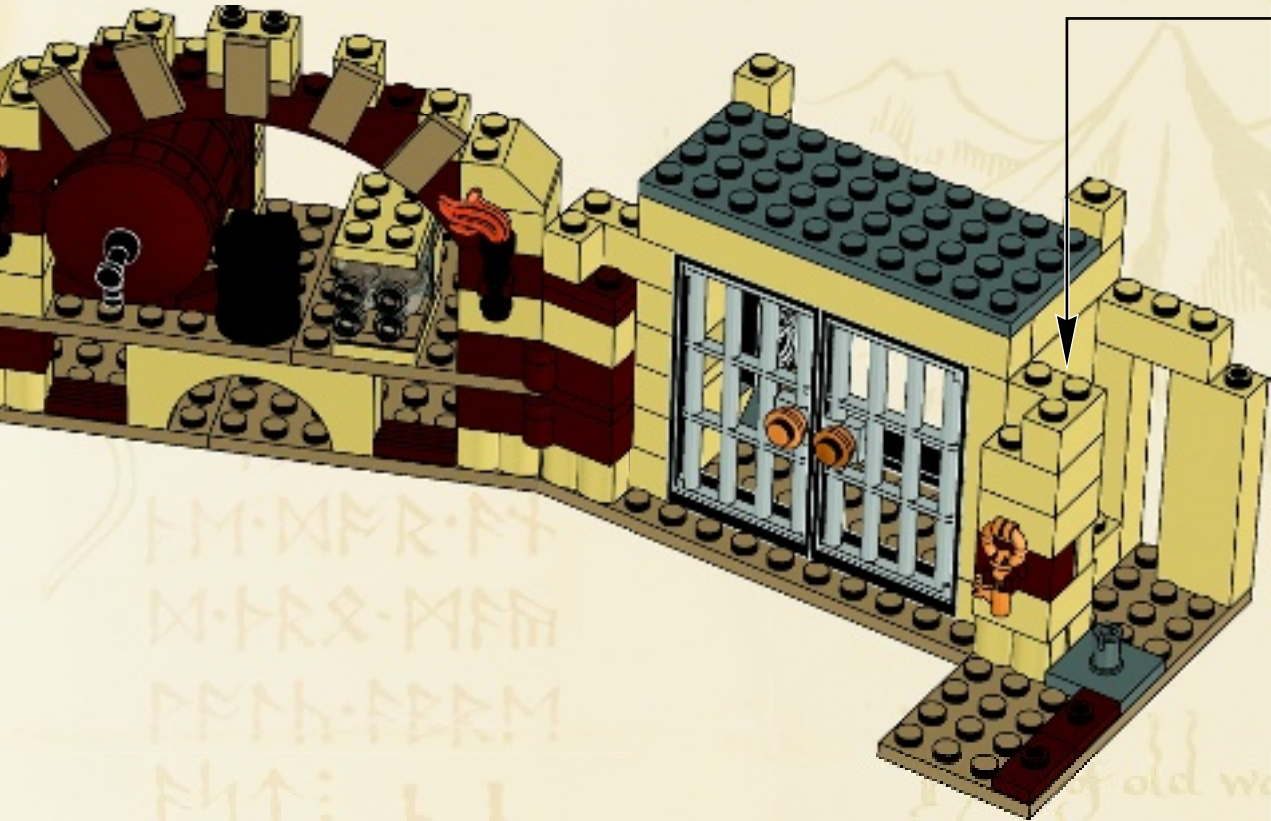
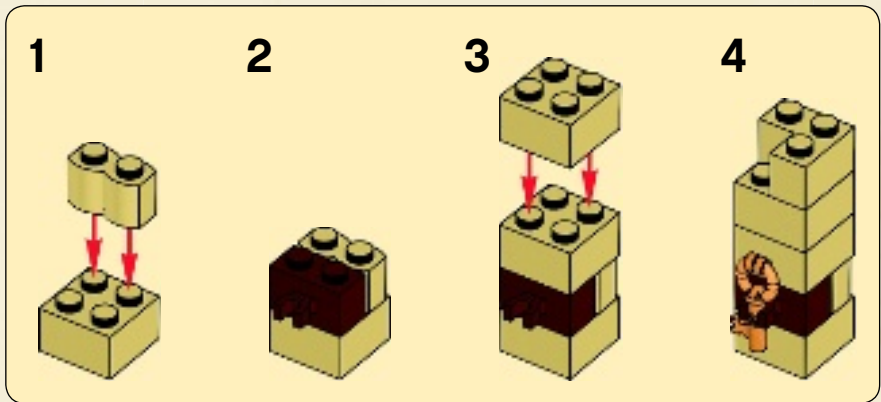

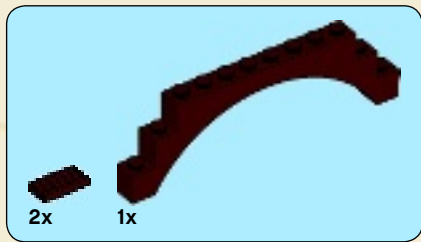

43

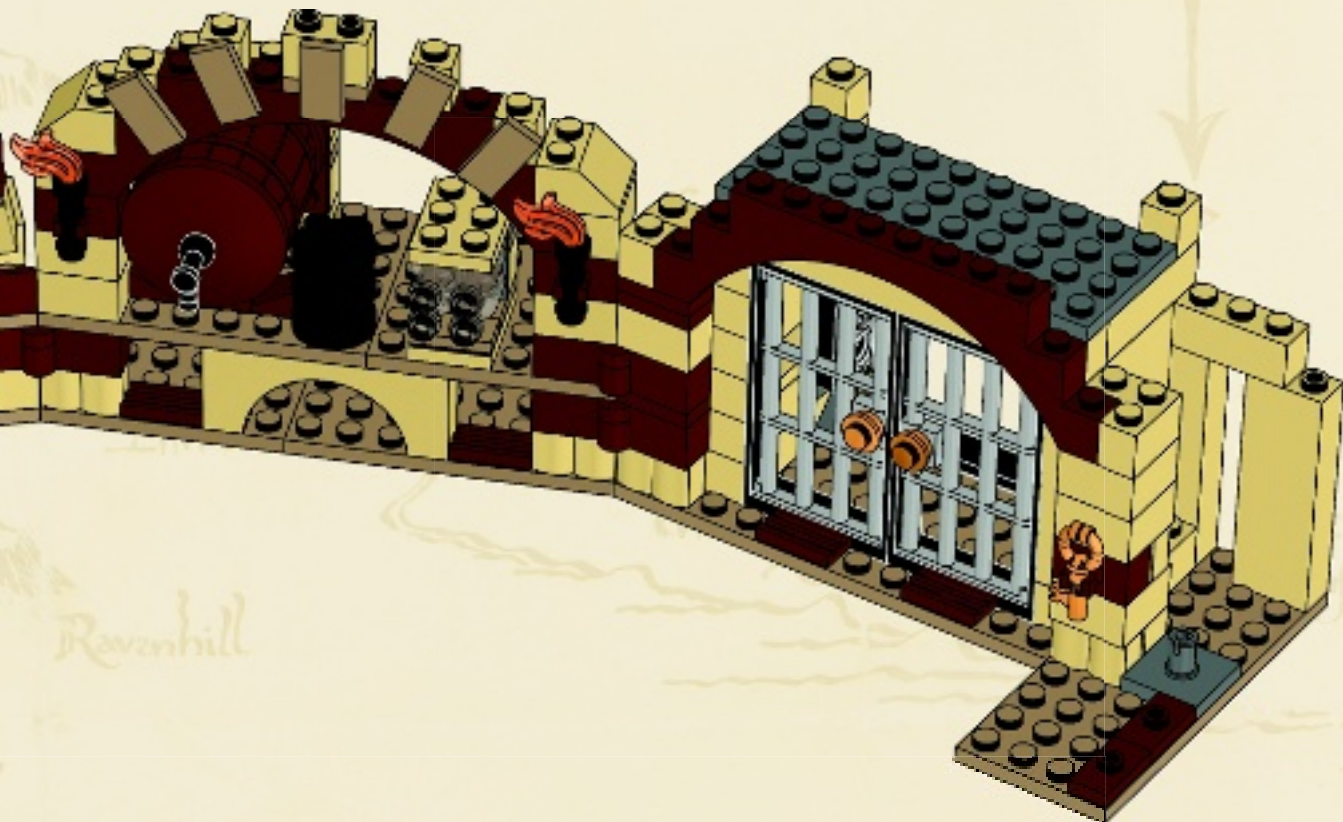

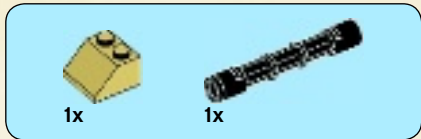

44

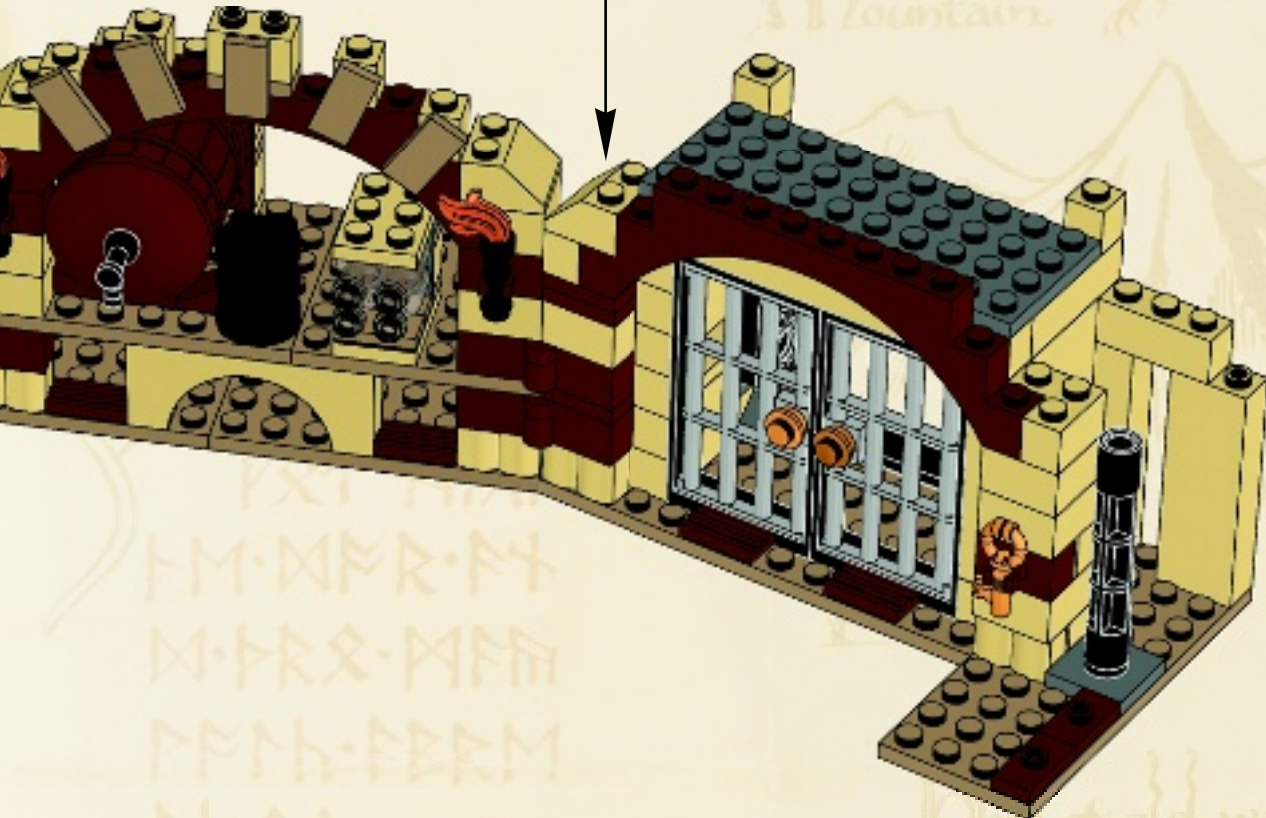
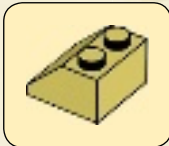



1x

45

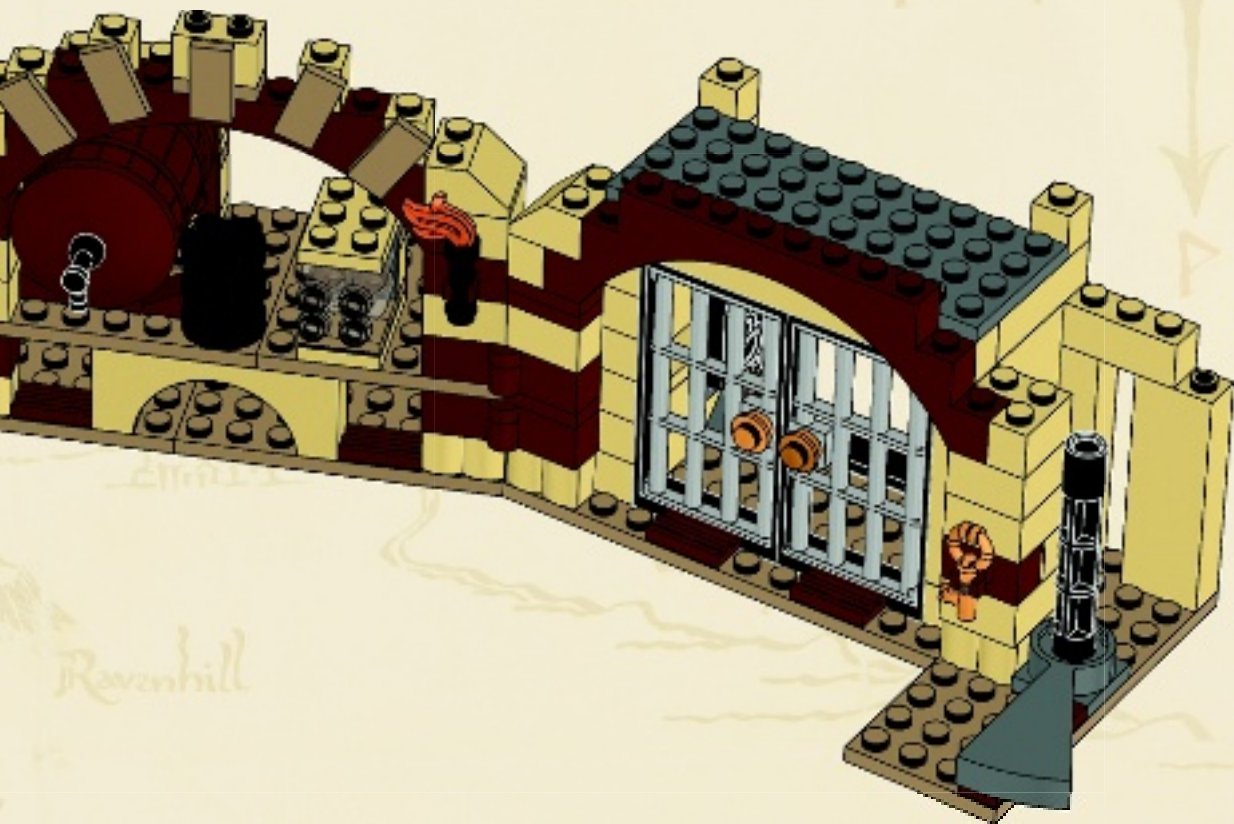

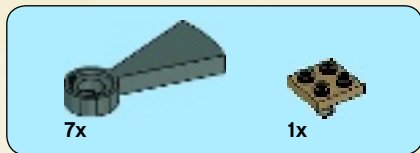

46

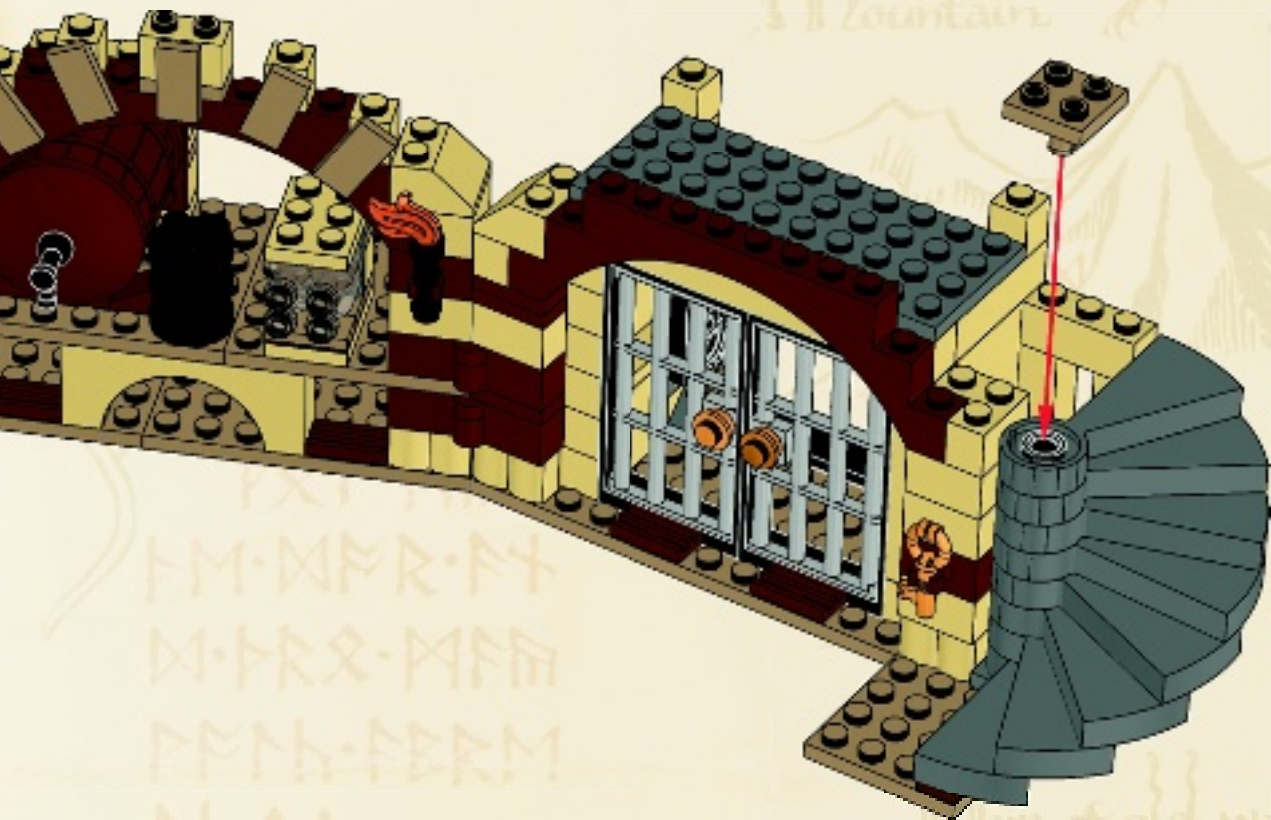



1x

47

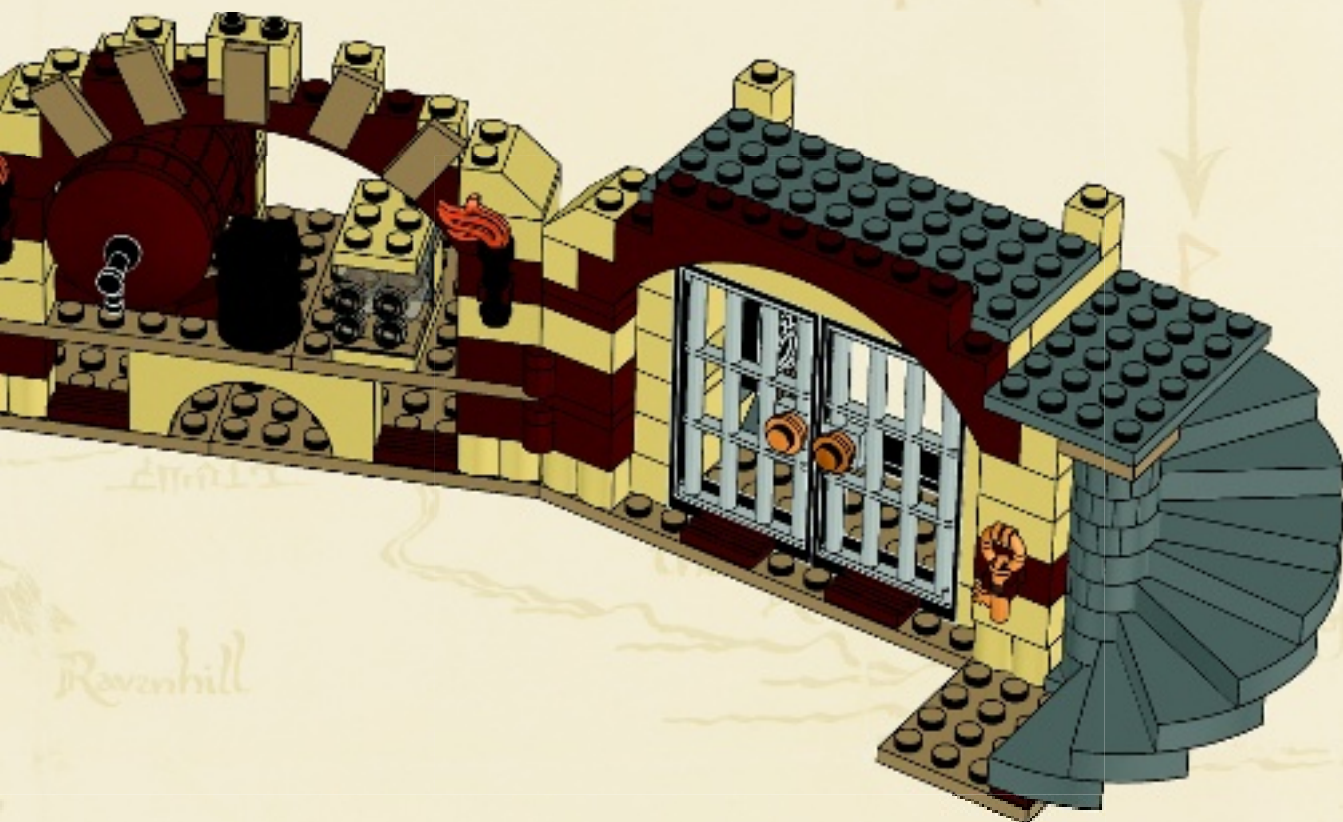

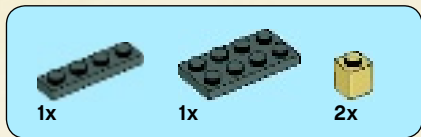

48

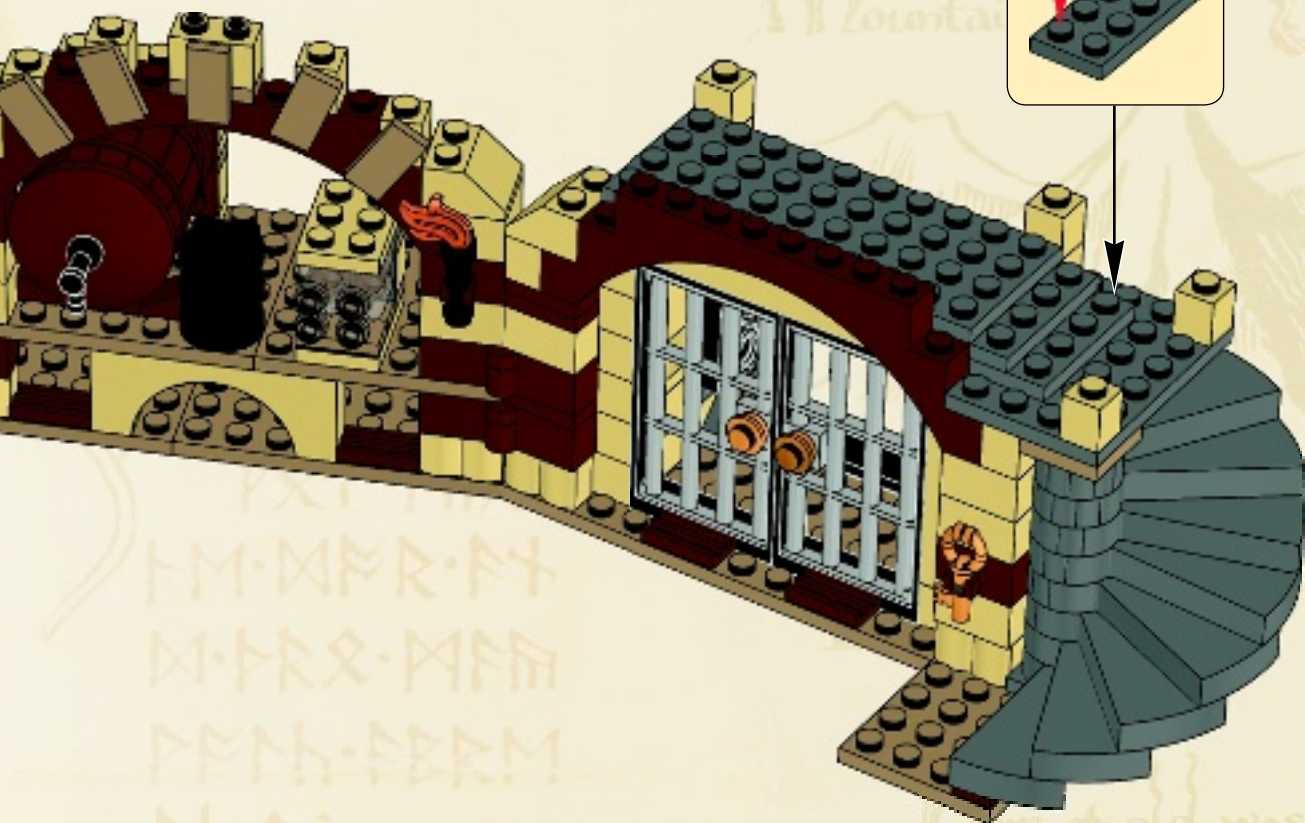
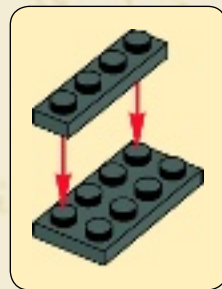



4x



1x

49

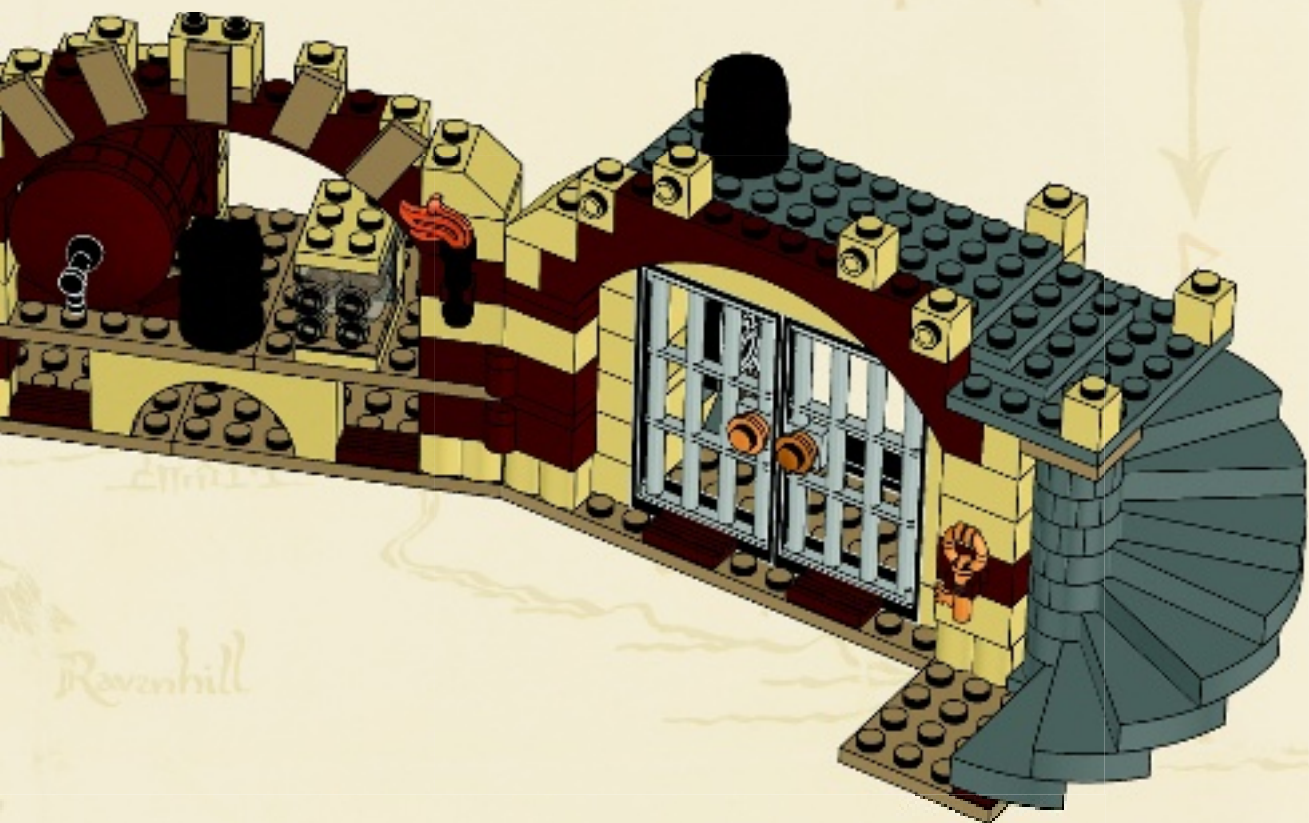

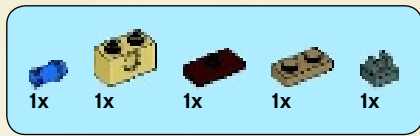

50

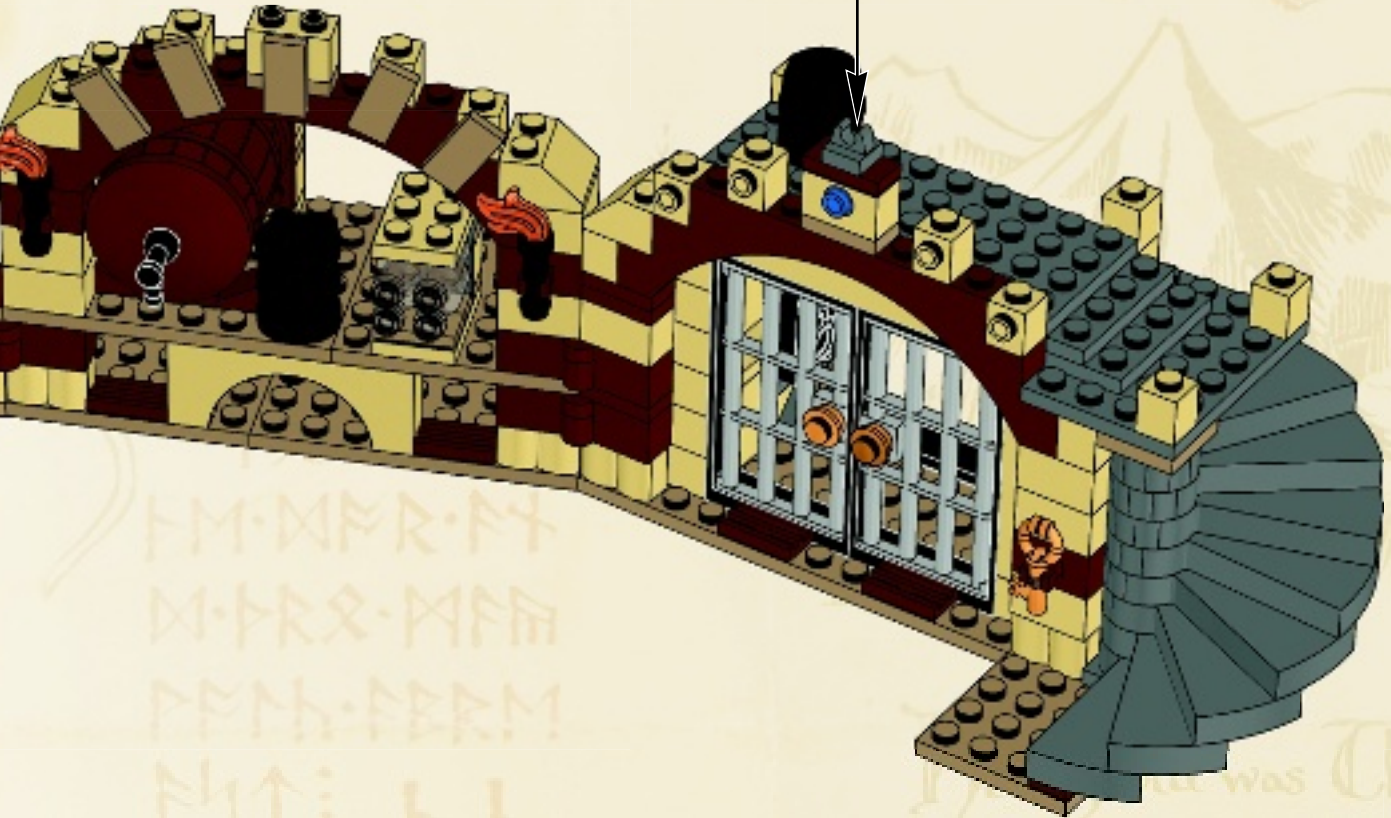
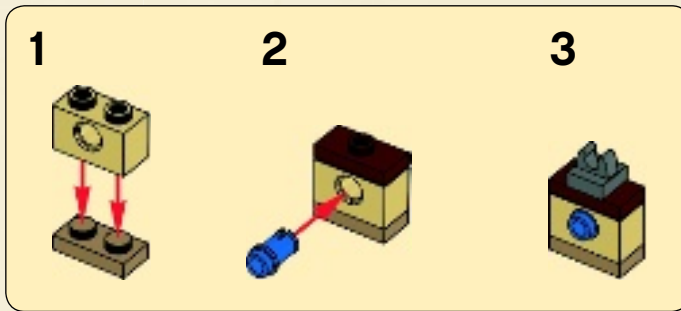



5x

51

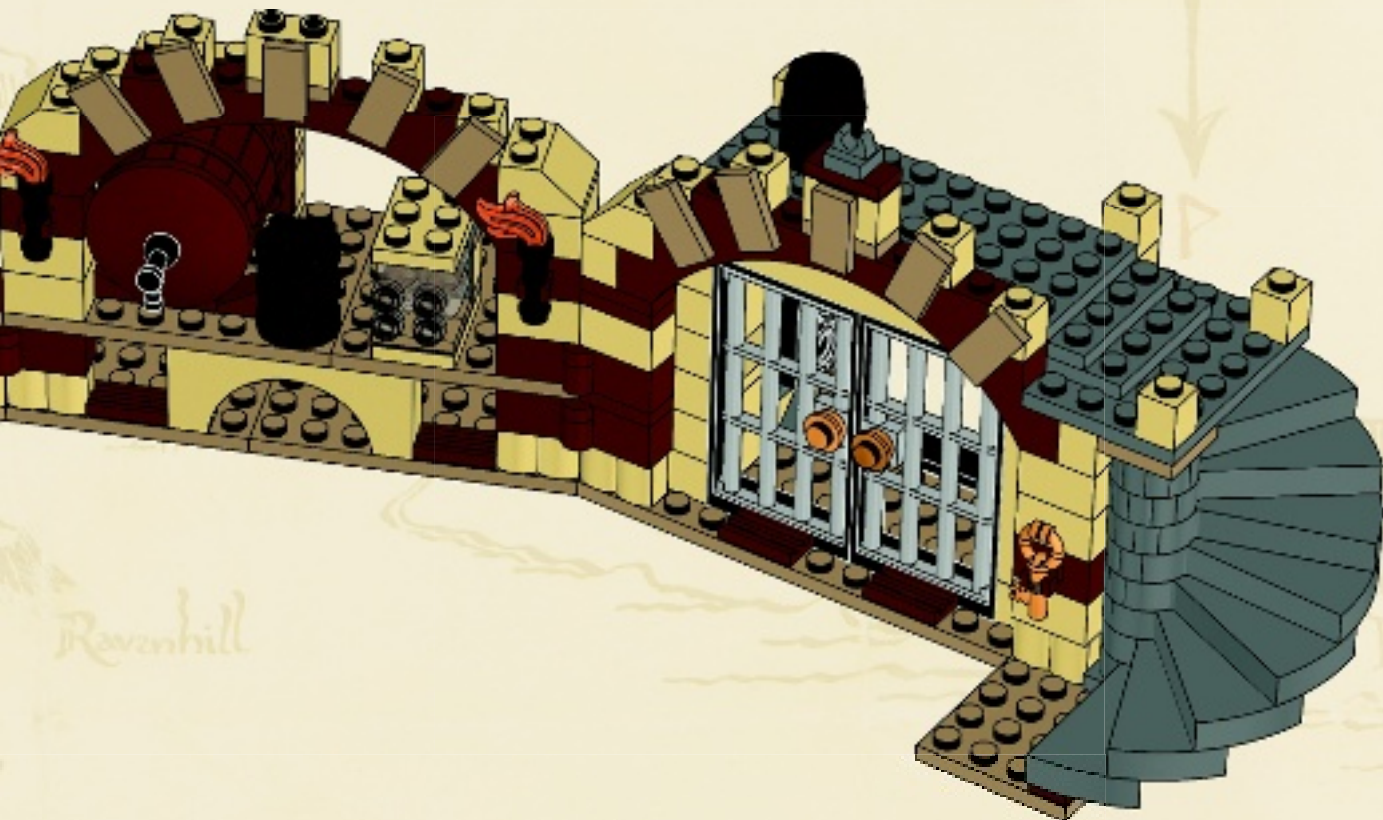

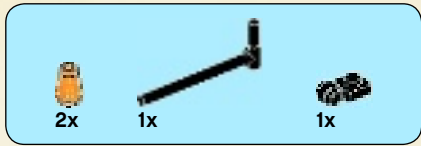

52

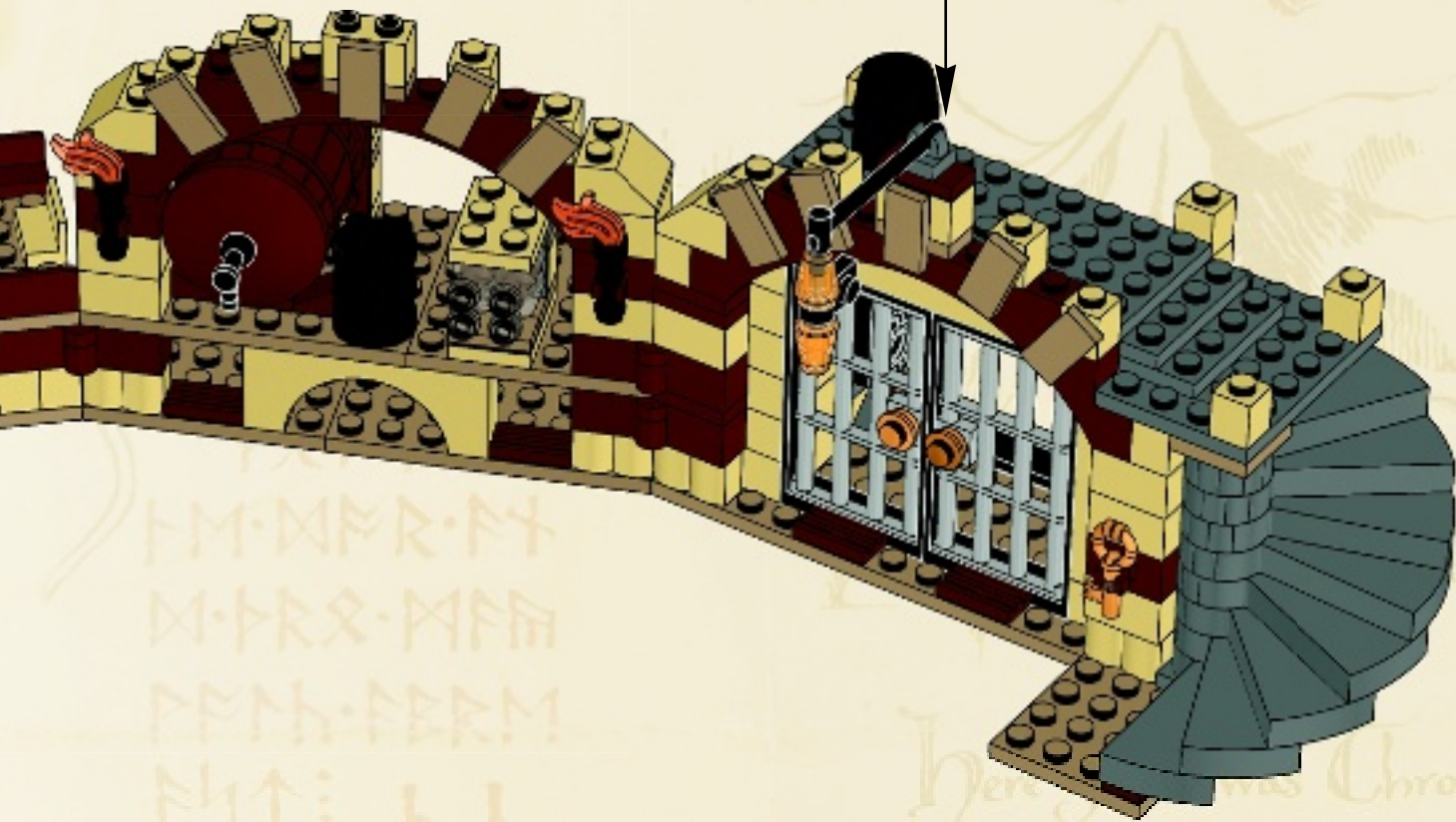
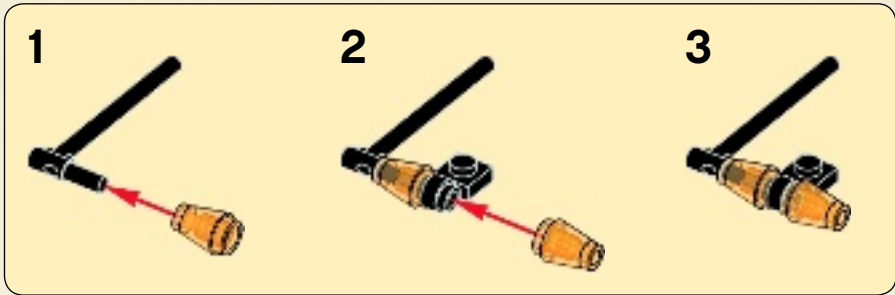

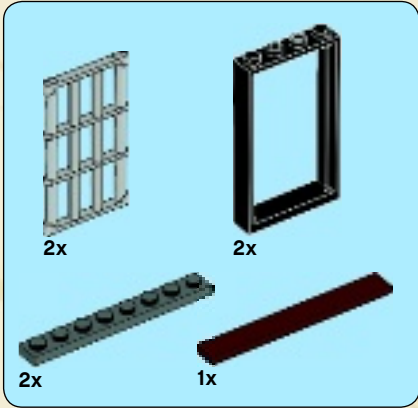
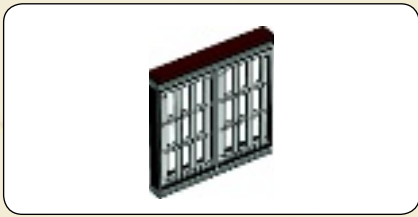

53

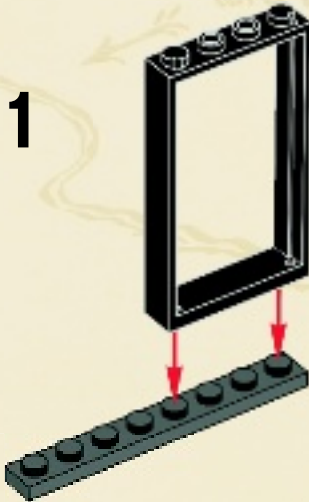

2

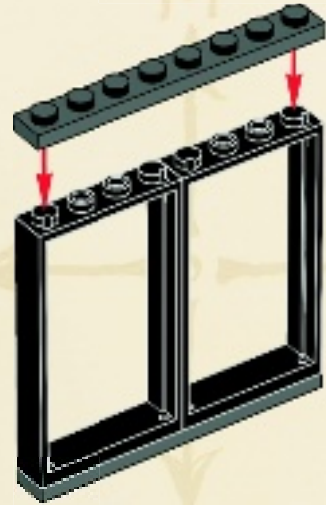

3

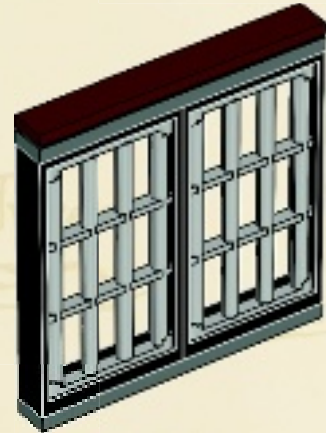

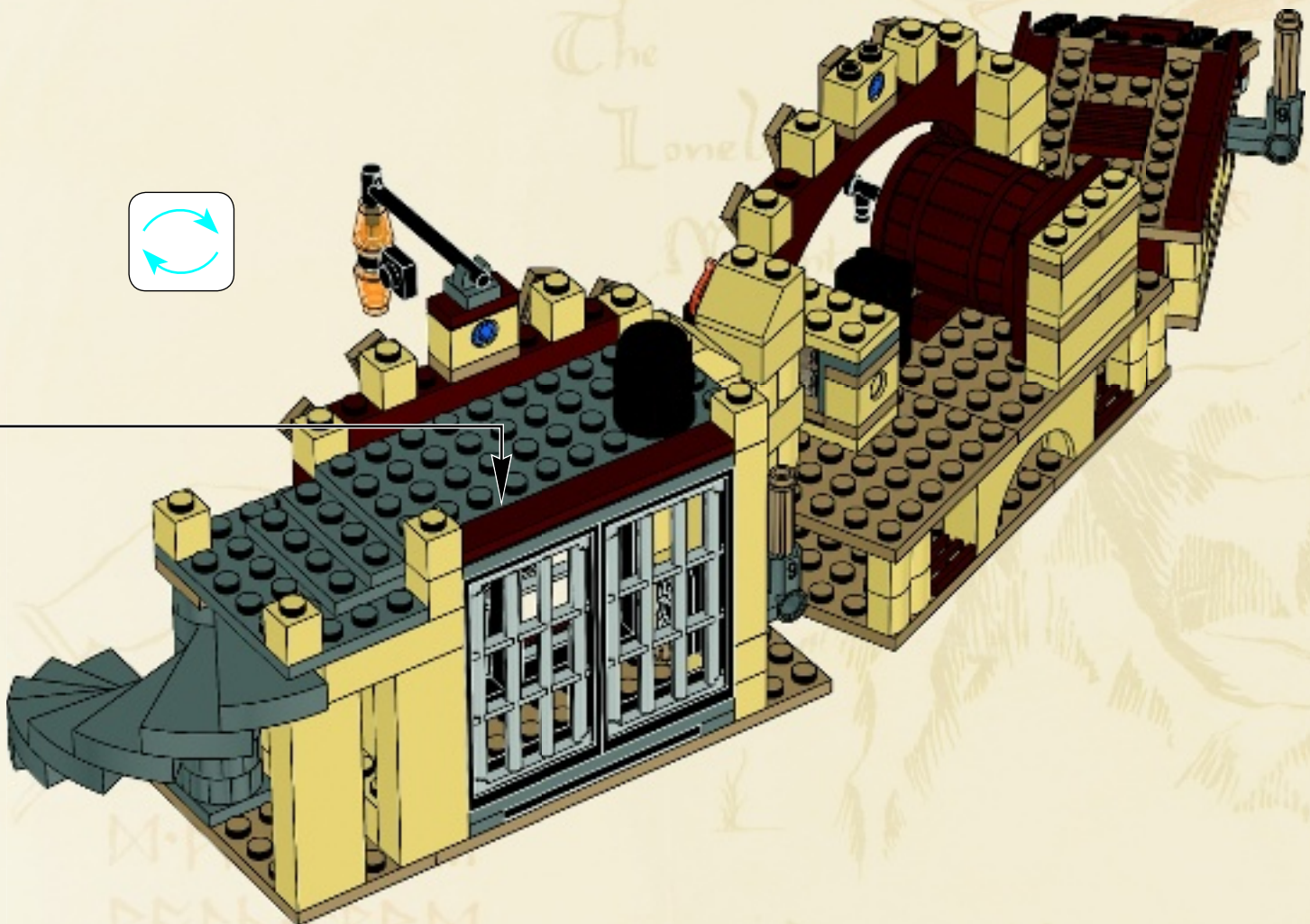
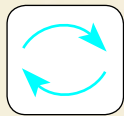

The
Love
Here of old was Thror
King under the Moun

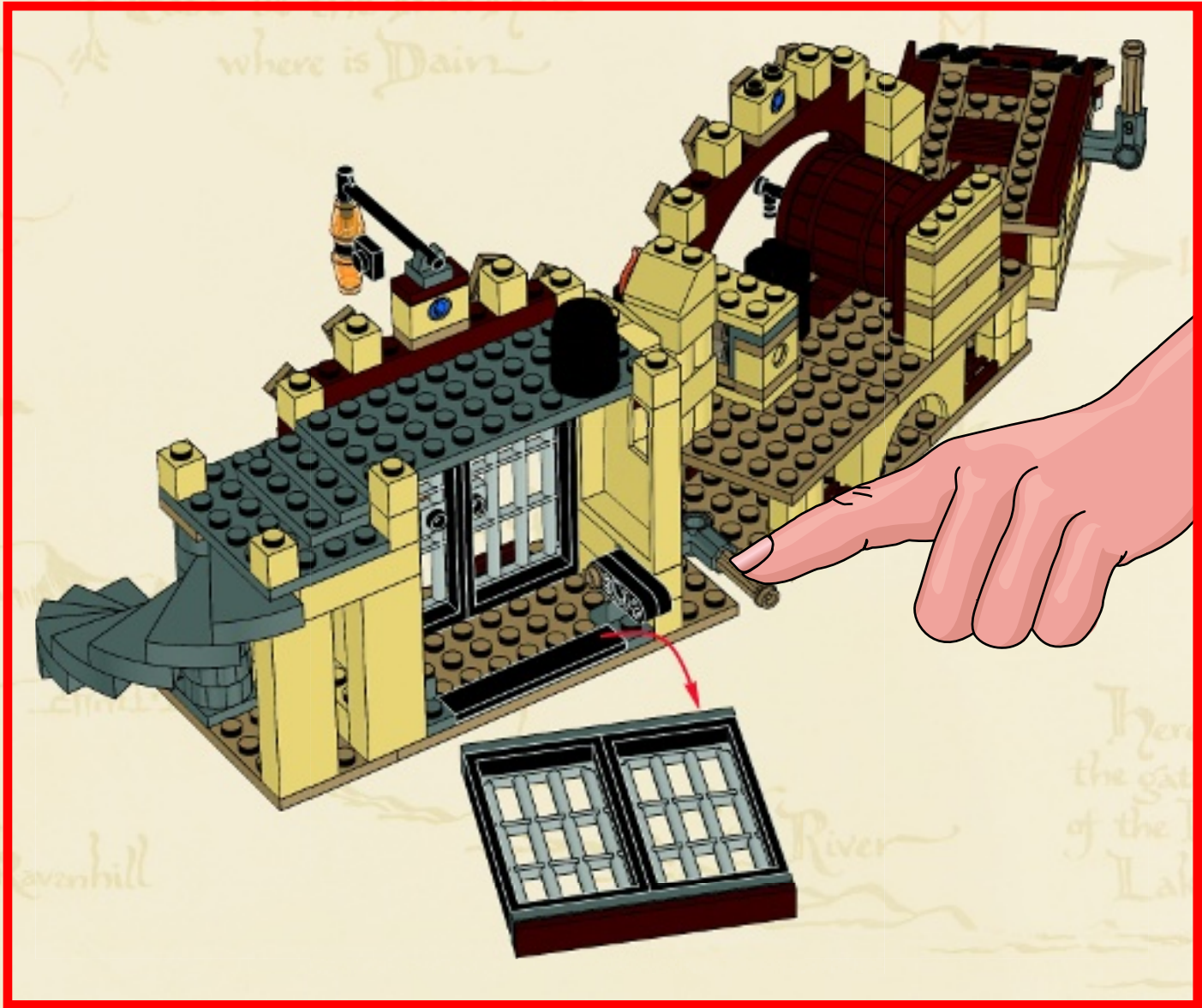

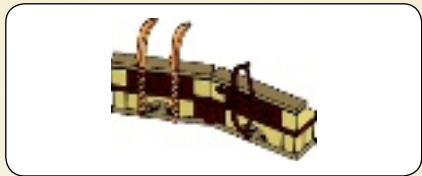

1

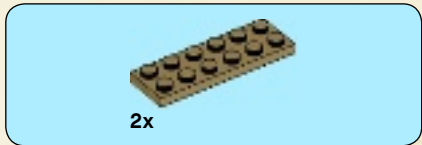
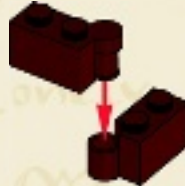

2

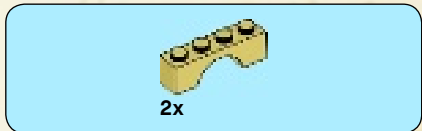
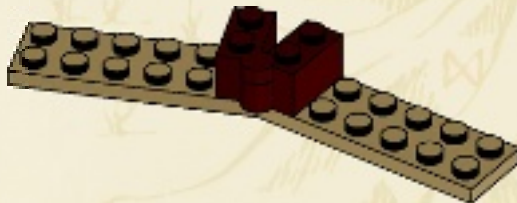

3

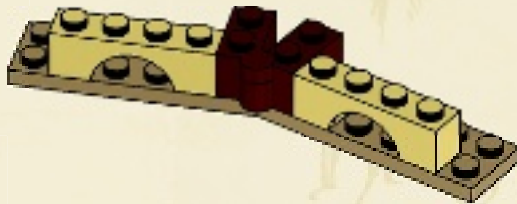



2x

4

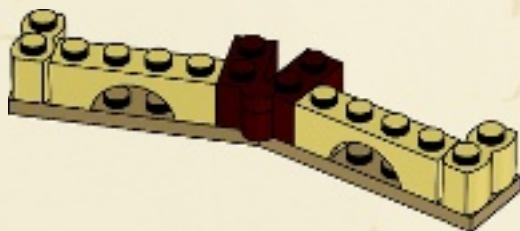

4x

5

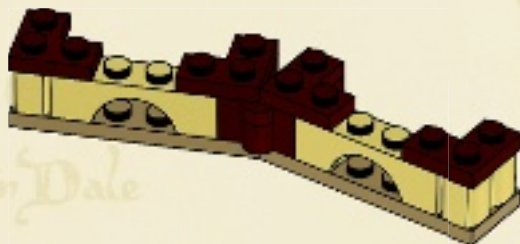

2x

6





4x

7

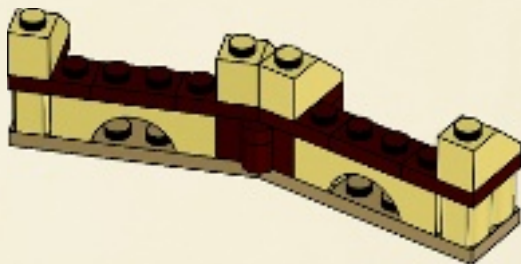

4x

8

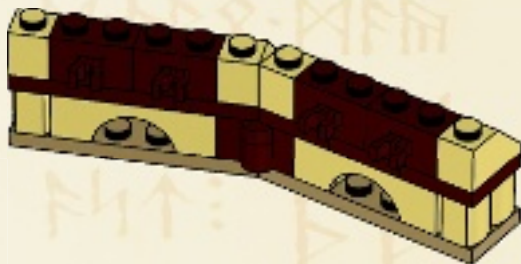

2x

9

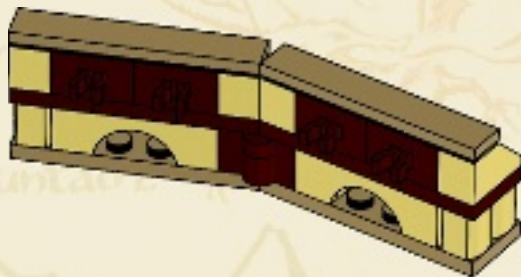

1x



2x

10

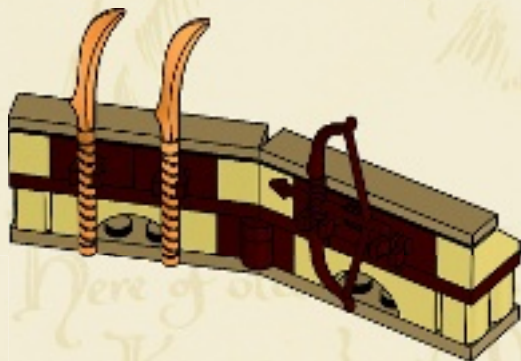

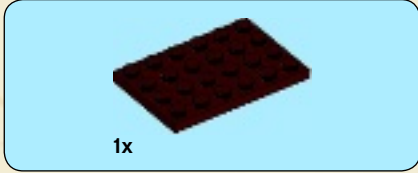

1



2

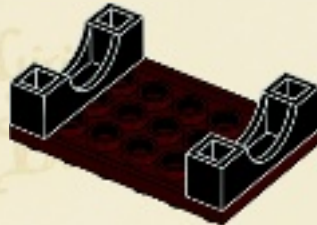

3





2x

4



1x



1x



2x

5

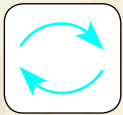

2x



2x



8x

6

1



2



3



2x





1x

1



2x

2



2x



1x



1x

3



1x

4





2x

5



1x



1x



1x

6



1x



1x



1x

7

1



2



↑ East lie the Iron Hills
where is Dain

M



Ravenhill

the Running River

Here is
the gateway
of the Long
Lake



1x
6022273



1x
6021594



1x
6022246



2x
4540865



2x
4567338



1x
4119410



2x
4535738

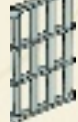

2x
4599496



2x
4610149



1x
6029941



1x
4211570



1x
6006032



1x
6015922



1x
6020525



1x
6020742



1x
6020770



6x
4523159



1x
6009771



2x
6013711



1x
6022033



1x
6002750



1x
6002763



1x
6022271



3x
4273965



2x
4623298



3x
4536677



3x
4538950



1x
6005225



1x
4529672



1x
6023064



1x
6028771



1x
6028771



1x
6030710



2x
4210671



8x
4153418



1x
6002173



1x
6002173



1x
4210639



2x
4210935



2x
4277928



1x
4211129



2x
4210633



2x
4621917



2x
4211094



2x
4211133



1x
4211001



1x
4211065



2x
4210998



1x
4211115



1x
4211122



1x
4211122



2x
6016059



12x
4528604



13x
4496699



1x
4541618



4x
6013821



2x
4507047



2x
4550329



5x
4246957



3x
4530712



2x
4251796



1x
6001001



1x
4266897



Customer Service

Kundenservice

Service Consommateurs

Servicio Al Consumidor

LEGO.com/service or dial



: 00800 5346 5555

: 1-800-422-5346



□ 79010
Goblin Soldier
Soldat gobelin
Soldado Trasgo



□ 79010
Nori the Dwarf
Le nain Nori
Nori el Enano

□ 79010
Goblin Soldier
Soldat gobelin
Soldado Trasgo



□ 79010
Dori the Dwarf
Le nain Dori
Dori el Enano



□ 79004
Bilbo Baggins™



□ 79003
Dwalin the Dwarf
Le nain Dwalin
Dwalin el Enano



□ 79002
Hunter Orc
Orque chasseur
Orco Cazador



□ 79010
The Goblin King
Le roi des gobelins
El Rey Trasgo



□ 79004
Óin the Dwarf
Le nain Óin
Óin el Enano



□ 79004
Mirkwood™ Elf Chief
Le chef des elfes de Mirkwood™
Jefe Elfo del Mirkwood™



□ 79003
Balin the Dwarf
Le nain Balin
Balin el Enano



□ 79010
Gandalf™ the Grey
Gandalf™ le Gris
Gandalf™ el Gris



□ 79001
Kili the Dwarf
Le nain Kili
Kili el Enano



□ 79003
Bilbo Baggins™



□ 79000
Bilbo Baggins™

□ 79000
Gollum™



□ 79003
Bofur the Dwarf
Le nain Bofur
Bofur el Enano



□ 79004
Mirkwood™ Elf Guard
Garde elfe de Mirkwood™
Guardia Elfo del Mirkwood™



□ 79004
Gloin the Dwarf
Le nain Glóin
Gloin el Enano



□ 79001
Fili the Dwarf
Le nain Fili
Fili el Enano



□ 79001
Legolas Greenleaf™



□ 79002
Thorin Oakenshield™



□ 79002
Yazneg™



□ 79002
Warg
Ouargue
Wargo



□ 79002
Warg
Ouargue
Wargo



□ 79002
Bifur the Dwarf
Le nain Bifur
Bifur el Enano

□ 79010
Goblin Scribe
Scribe goblin
Escriba Trasgo



□ 79010
Ori the Dwarf
Le nain Ori
Ori el Enano



□ 79003
Bombur the Dwarf
Le nain Bombur
Bombur el Enano



□ 79003
Gandalf™ the Grey
Gandalf™ le Gris
Gandalf™ el Gris



□ 79001
Tauriel™



□ 79002
Hunter Orc
Orque chasseur
Orco Cazador

79010



79003



Here is
gaten
the Long
lake

79002





THE HOBBIT

AN UNEXPECTED JOURNEY

LEGO.com/thehobbit



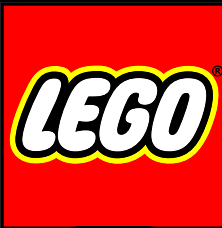

THE LORD OF THE RINGS



The Quest of the Fellowship
Continues in 2013



La quête de la Communauté
se poursuit en 2013



La Aventura de la Comunidad
Continúa en 2013

LEGO.com/thelordoftherings

THE HOBBIT™

AN UNEXPECTED JOURNEY

©2012 The LEGO Group.
THE HOBBIT: AN UNEXPECTED JOURNEY.
© NLP™ Middle-earth Ent. Lic. to New Line.
(s12)



3920
The Hobbit: An
Unexpected Journey

7+



2-4



15-25



GAMES





WIN!

Go to www.LEGOsurvey.com/product to fill out a survey for a chance to win a cool LEGO® Product. No purchase necessary. Open to all residents where not prohibited.



www.LEGOsurvey.com/product

GEWINNE! WIN!

Nimm an der Umfrage auf www.LEGOsurvey.com/product teil und hab die Chance ein cooles LEGO® Produkt zu gewinnen!

Die Teilnahme am Gewinnspiel führt zu keinerlei Kaufverpflichtungen. Teilnahme in allen nicht ausgeschlossenen Ländern möglich.

Ga naar www.LEGOsurvey.com/product, vul een enquêteformulier in en maak kans op een cool LEGO® product.

Geen aankoopverplichting. Iedereen mag deelnemen, uitgezonderd ingezetenden van landen waar een enquêteverbod geldt.

GAGNE! 当てよう!

Visite www.LEGOsurvey.com/product pour répondre à un questionnaire et avoir une chance de gagner un produit LEGO® très cool!

Aucune obligation d'achat. Ouvert à tous les résidents des pays autorisés.

www.LEGOsurvey.com/product にアクセスして、アンケートにご記入ください。当選者にはレゴ®製品を差し上げます。

お買い上げの必要はありません。

禁止されていない限り、すべての皆様にご利用いただけます。



LEGO and the LEGO logo are trademarks of the/son des marques de commerce de/son marcas registradas de LEGO Group. ©2012 The LEGO Group. 6036623

THE HOBBIT: AN UNEXPECTED JOURNEY: © NLP™ Middle-earth Ent. Lic. to New Line. (s12)

LE HOBBIT : UN VOYAGE INATTENDU : © NLP™ Middle-earth Ent. Lic. à New Line. (s12)

EL HOBBIT: UN VIAJE INESPERADO: © NLP™ Middle-earth Ent.; uso autorizado a New Line. (s12)