

# BASIC

# 510

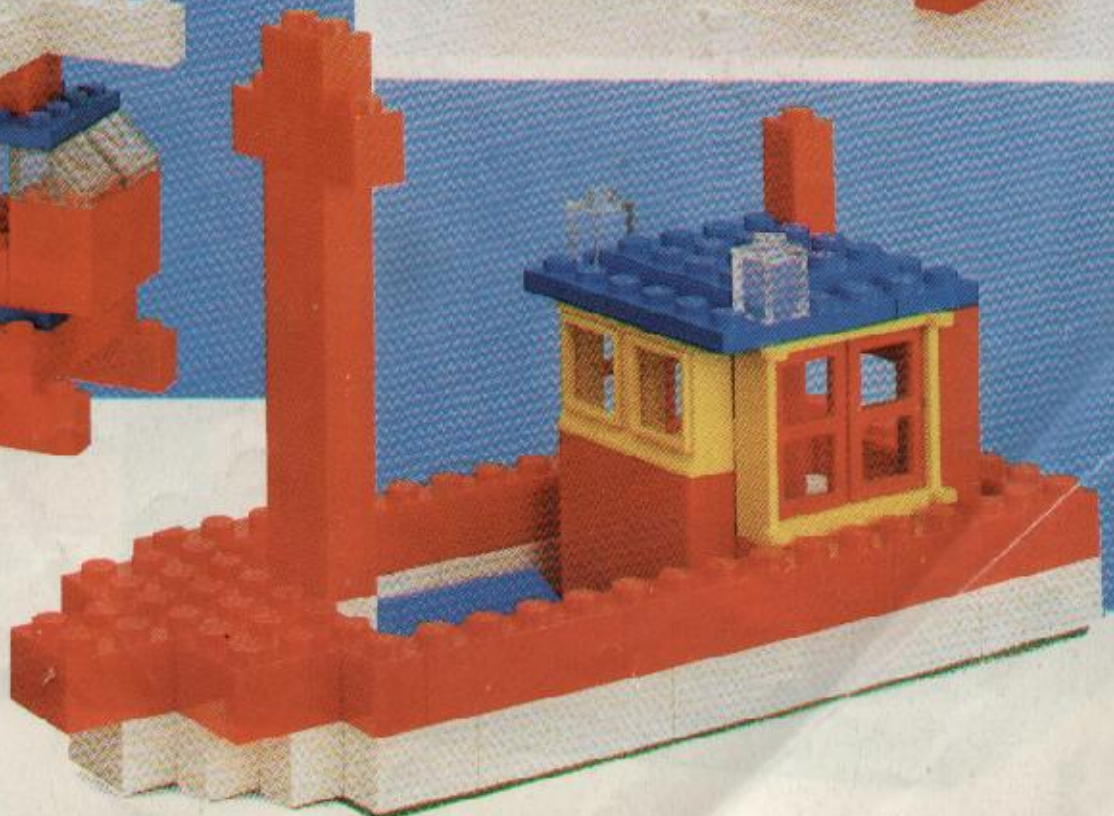

1

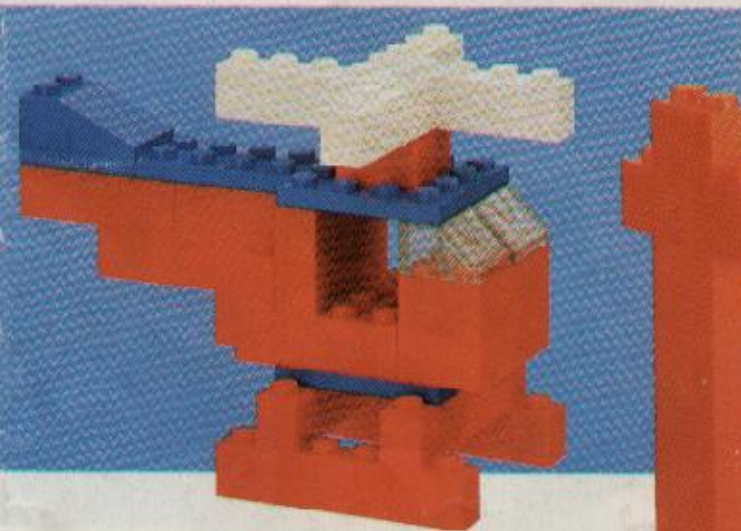
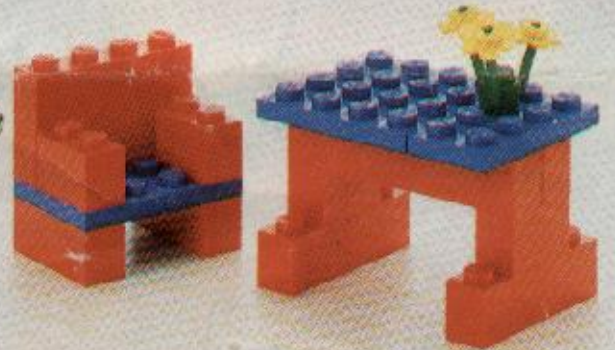
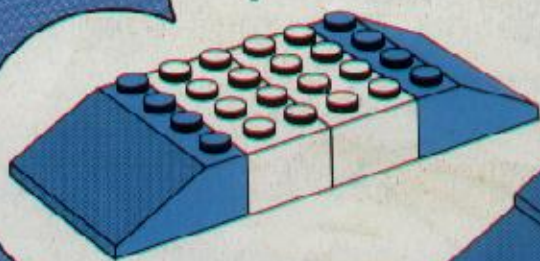

2

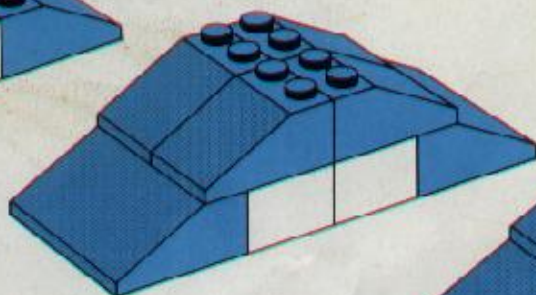

3

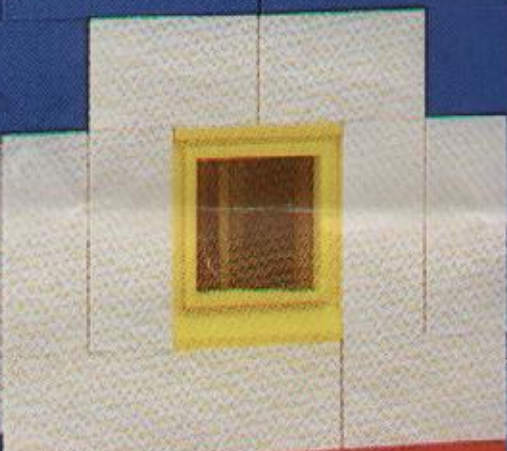
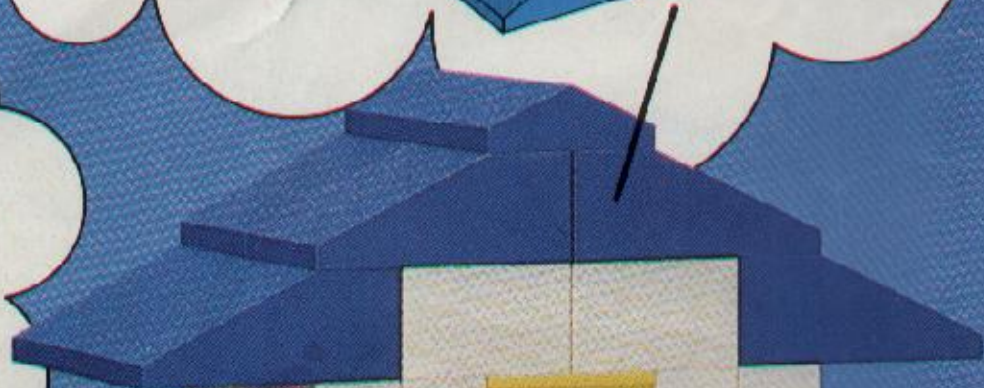
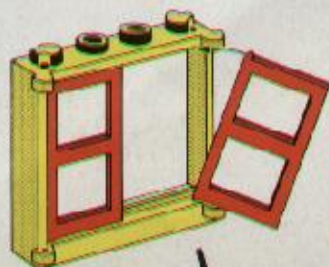
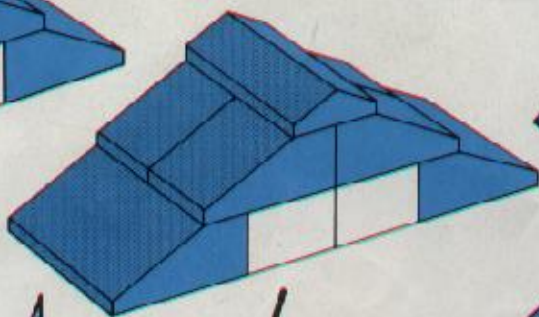

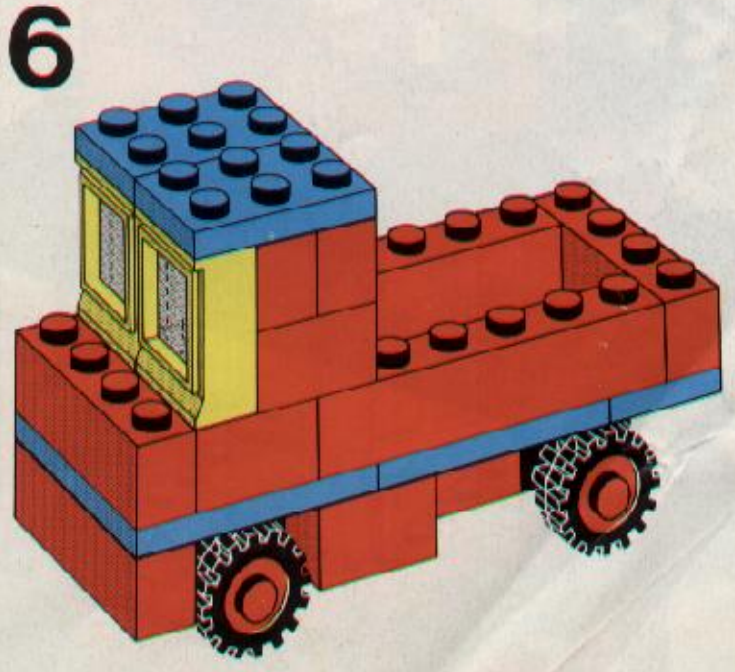
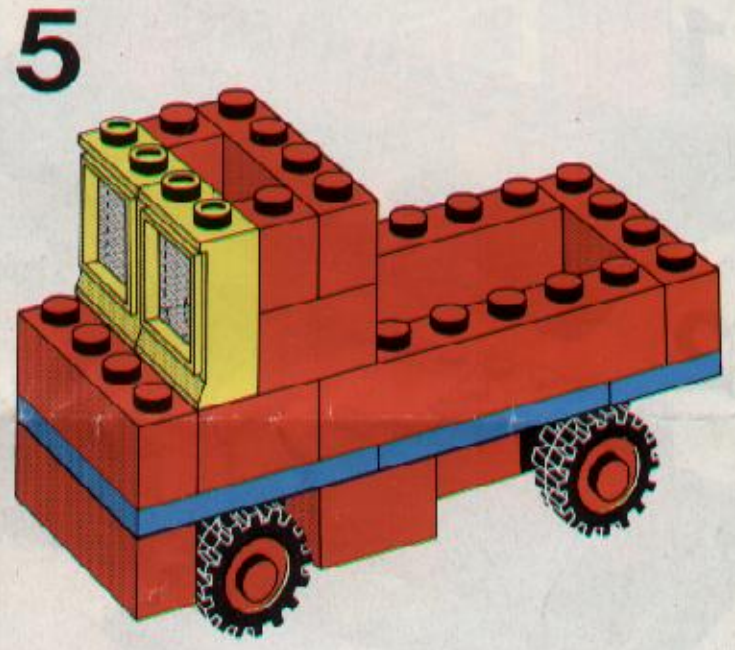
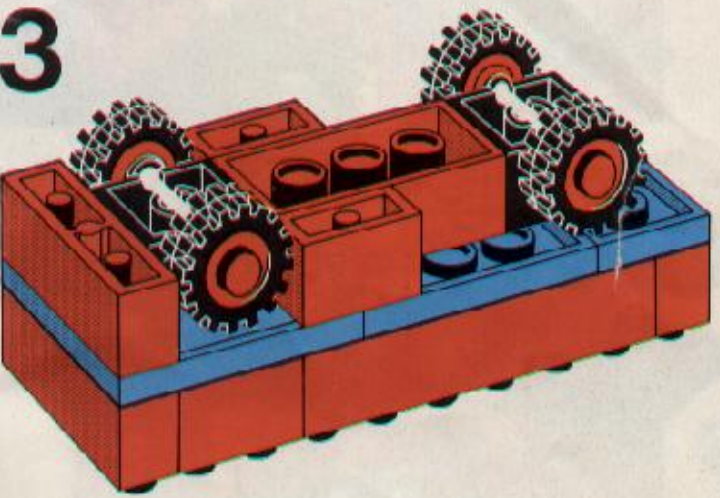
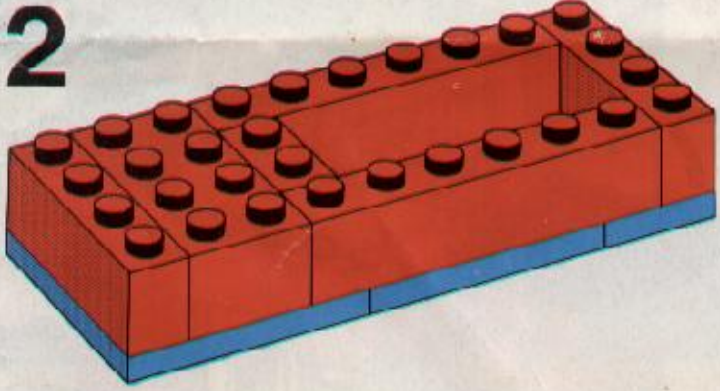
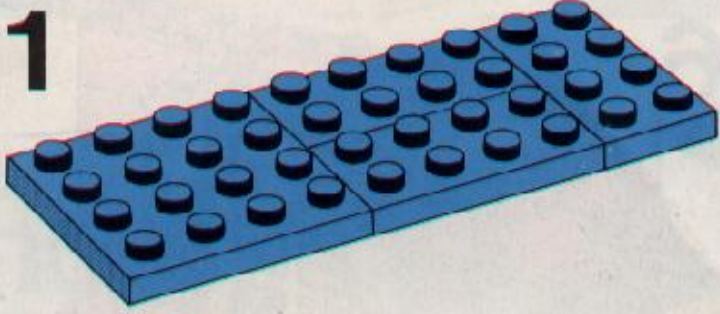
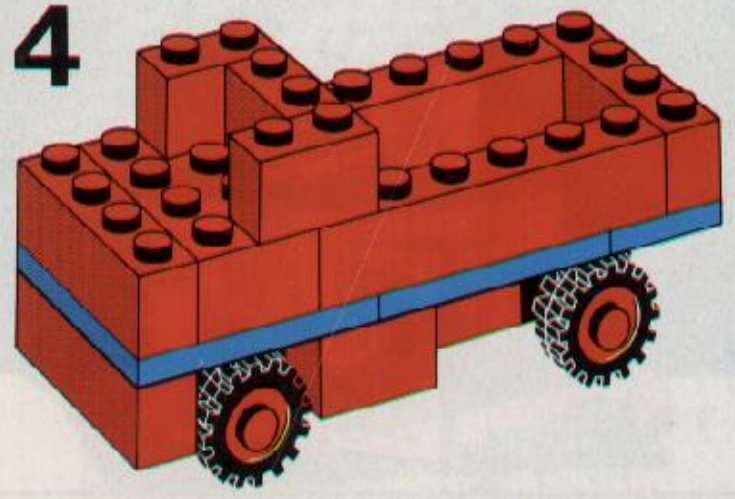
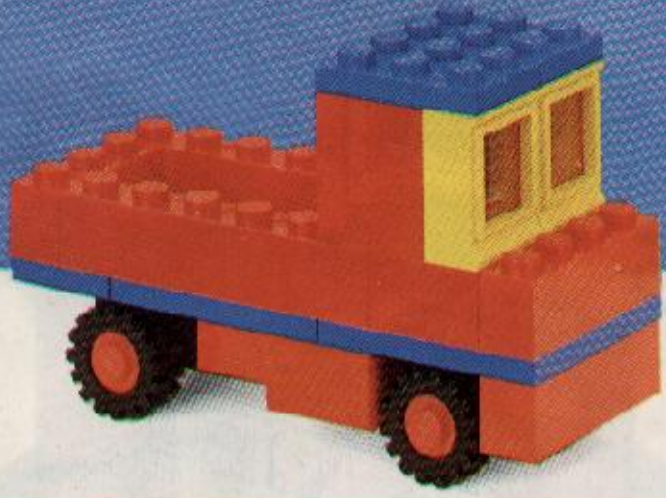

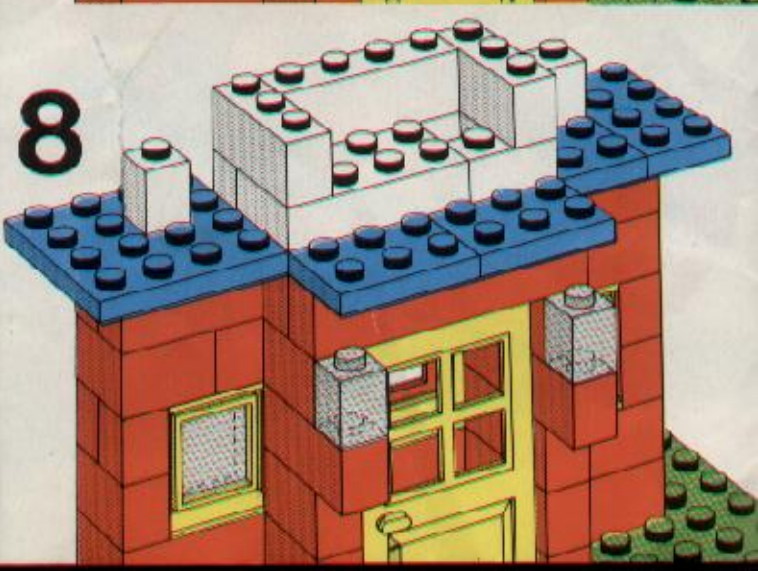
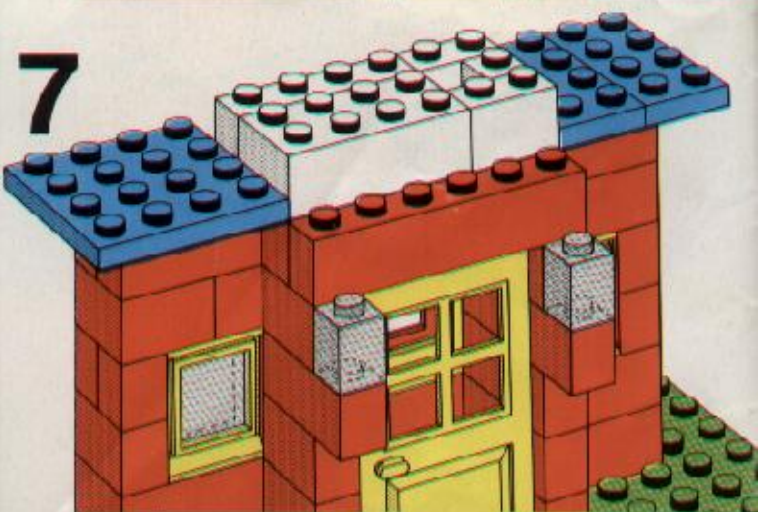
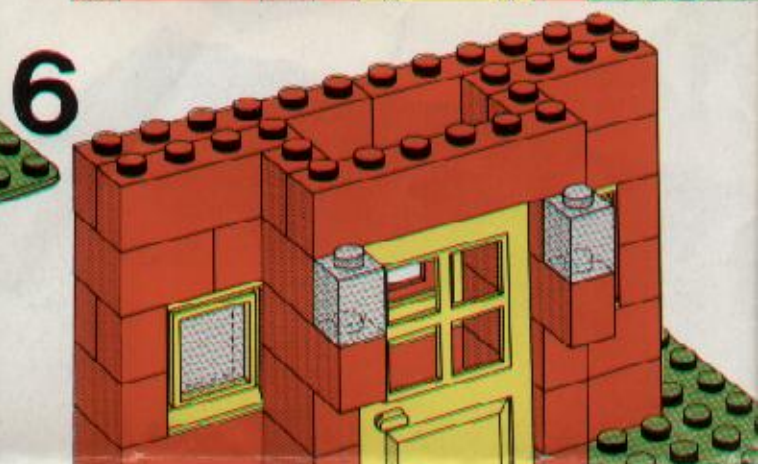
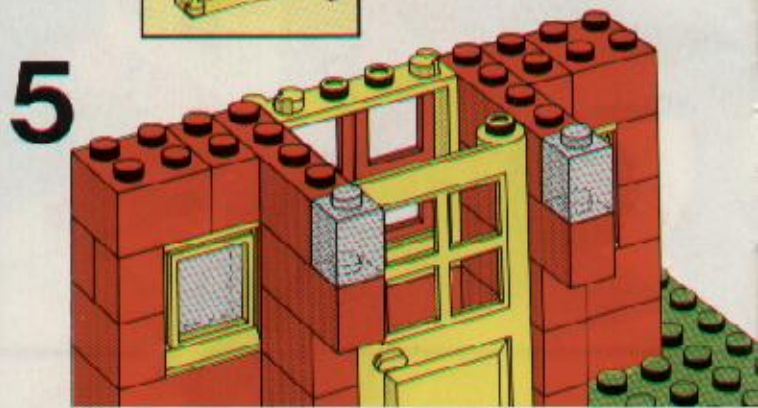
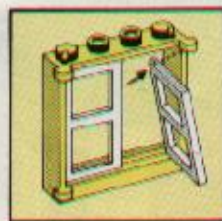
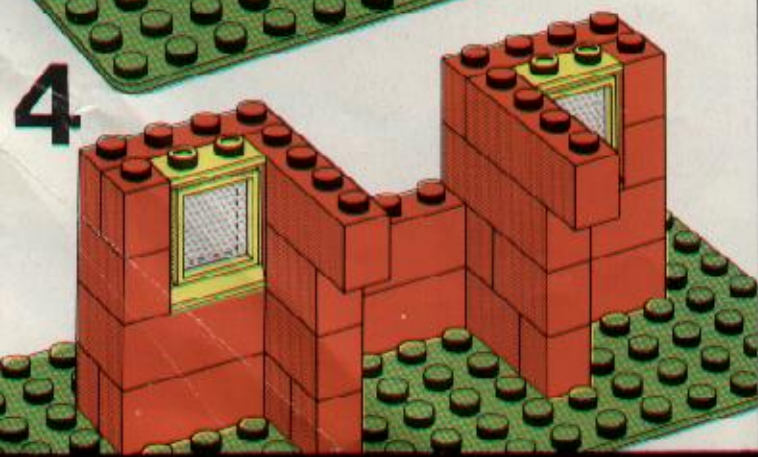
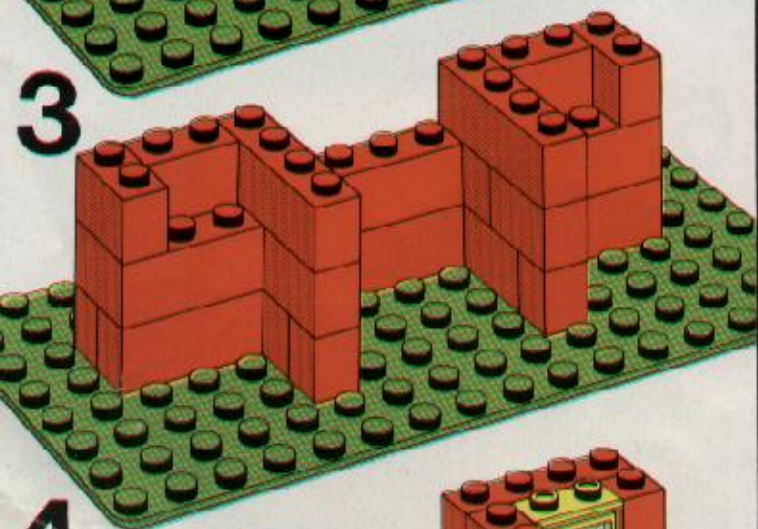
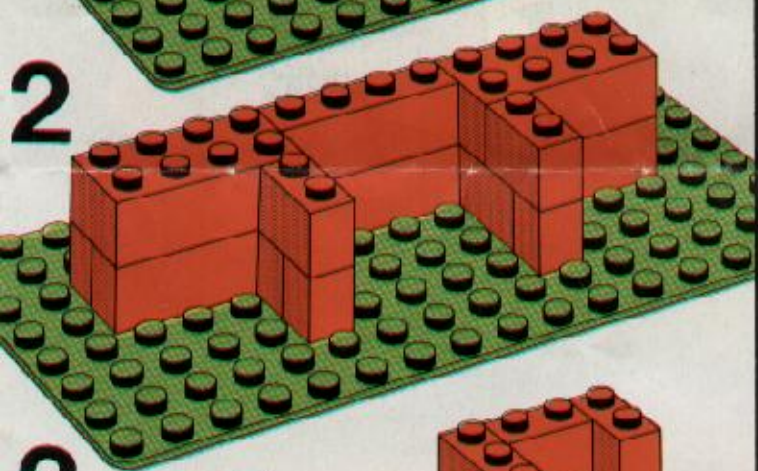
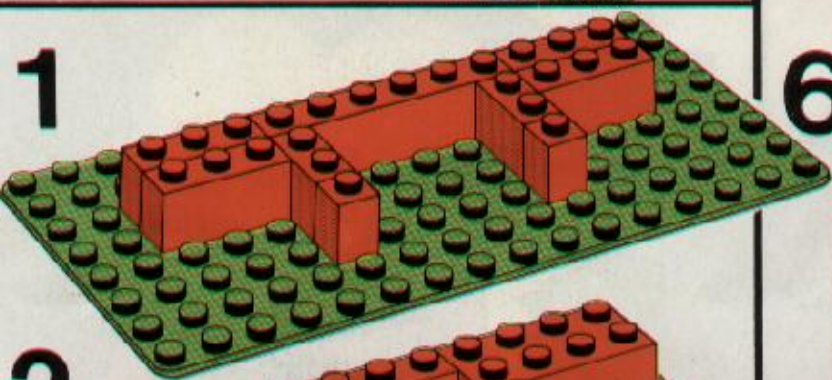

9

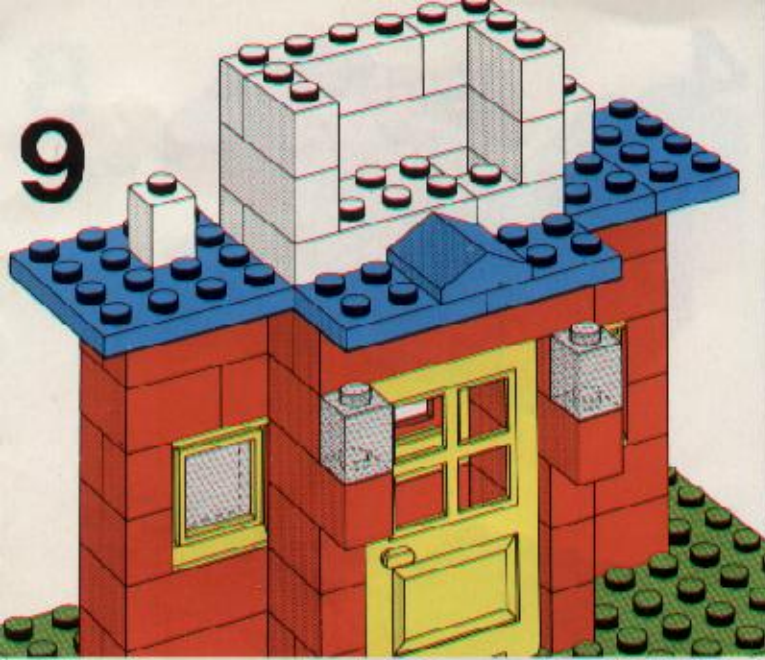

12

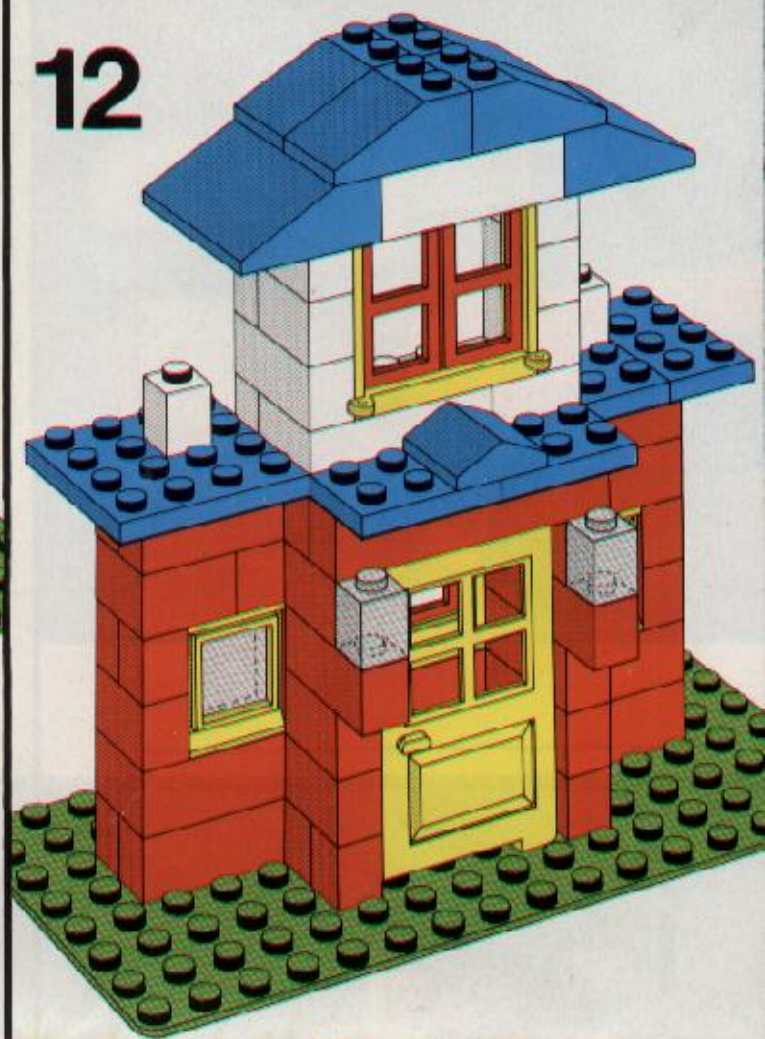

10

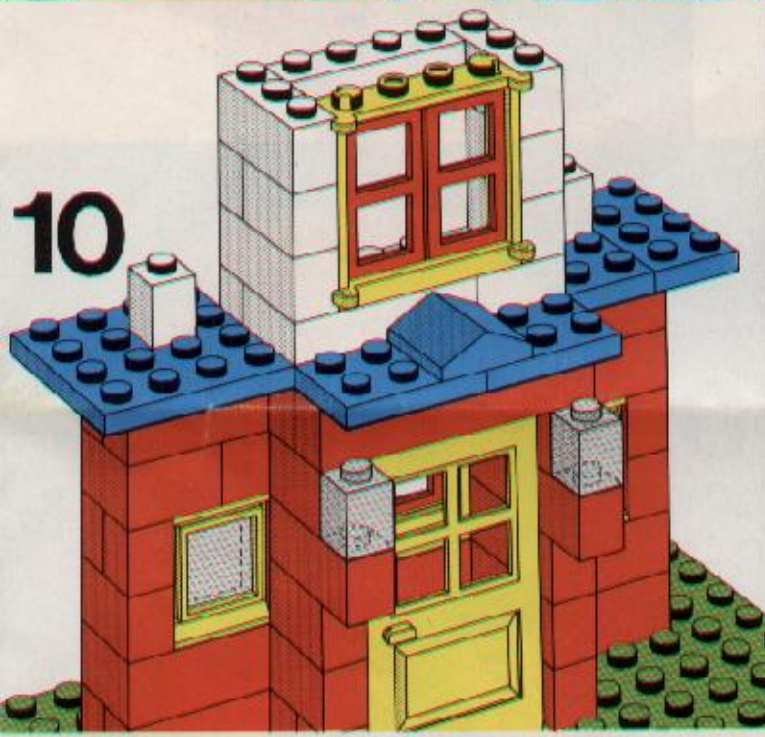

13

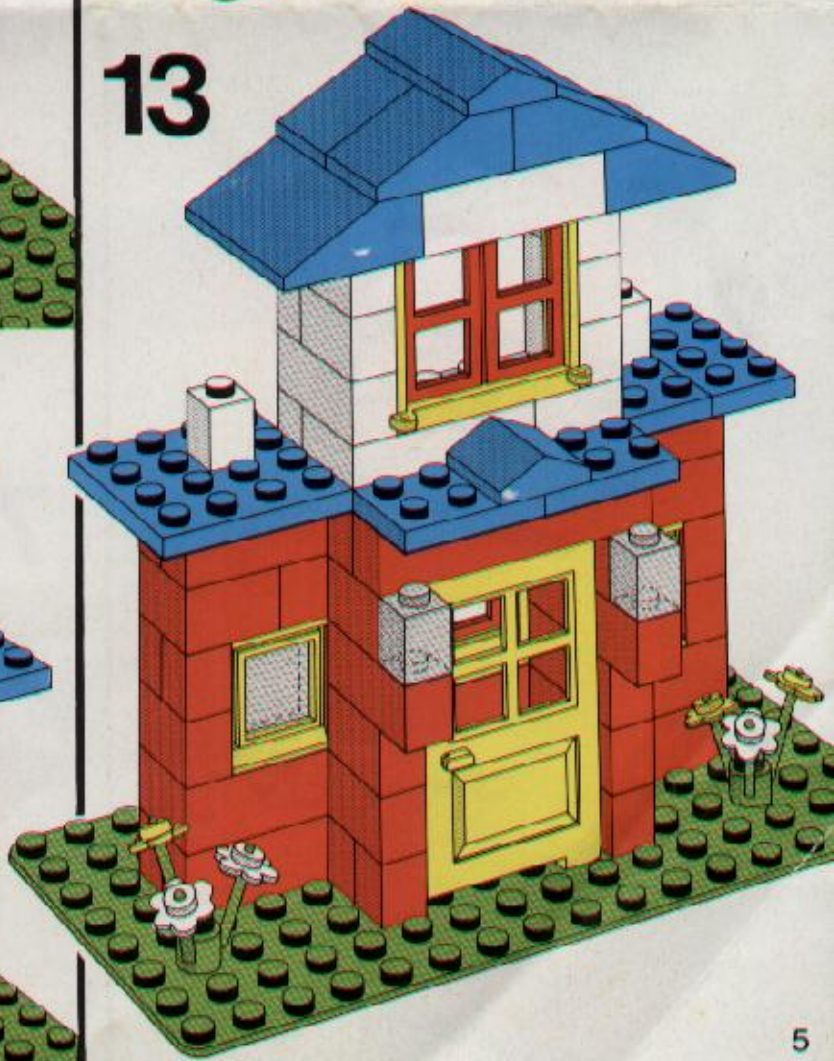

11

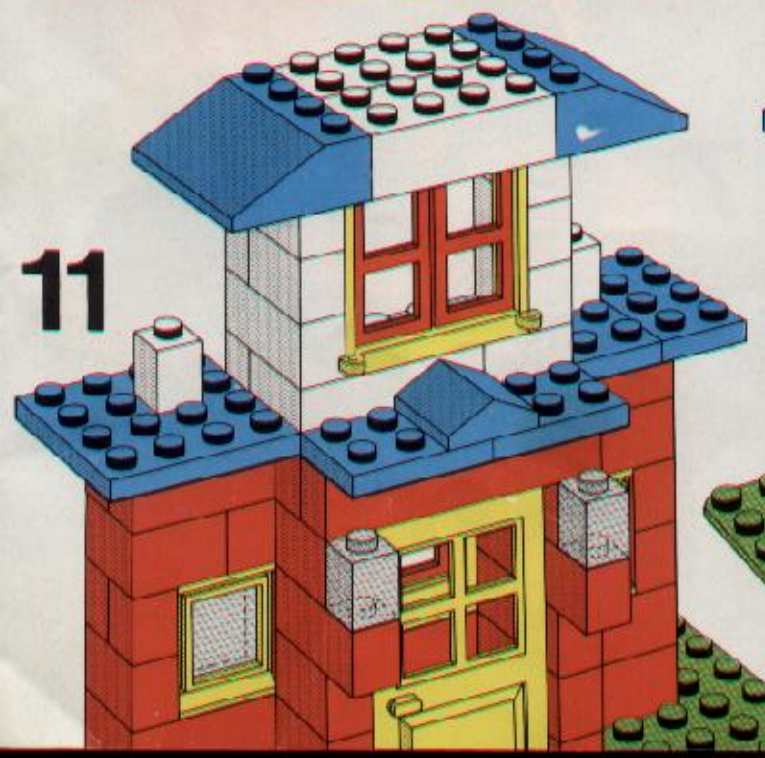

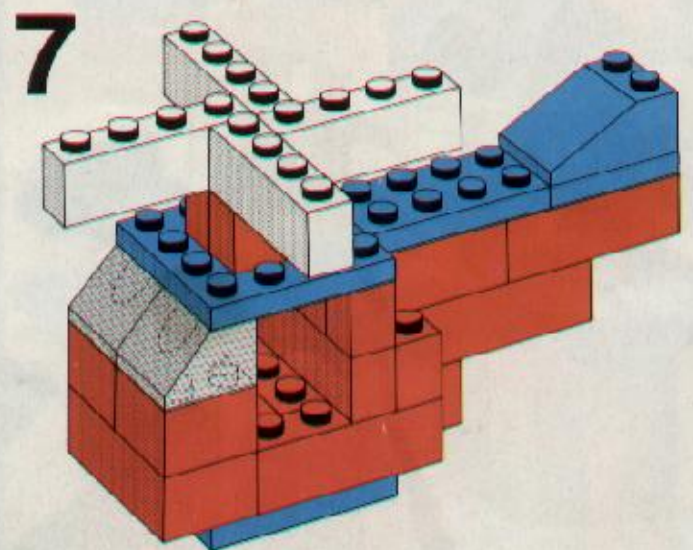
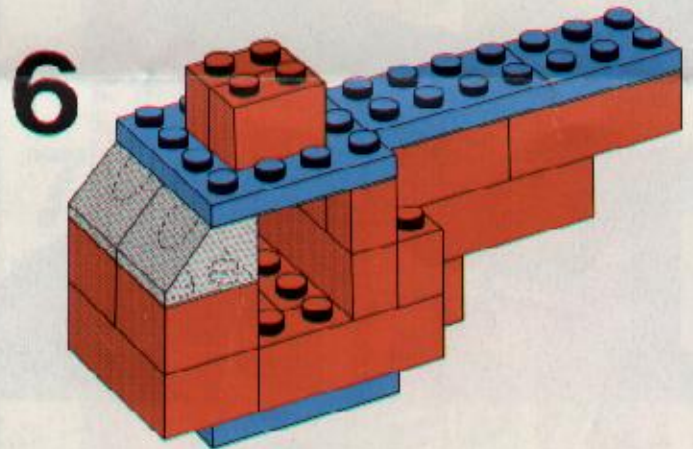
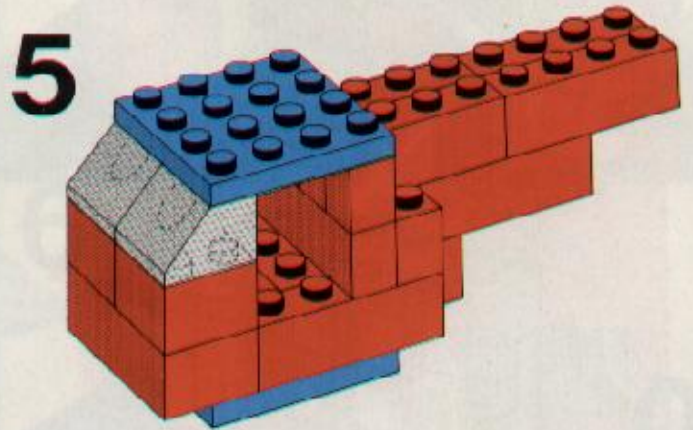
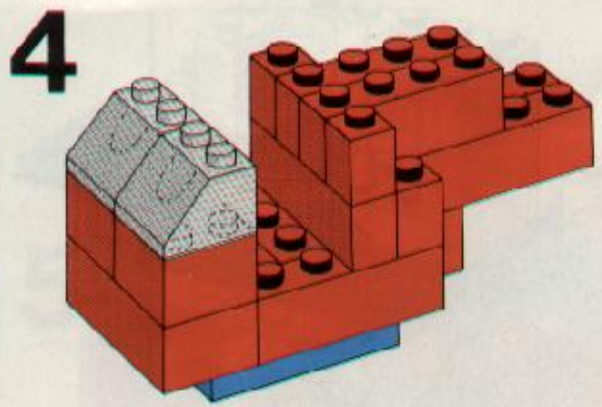
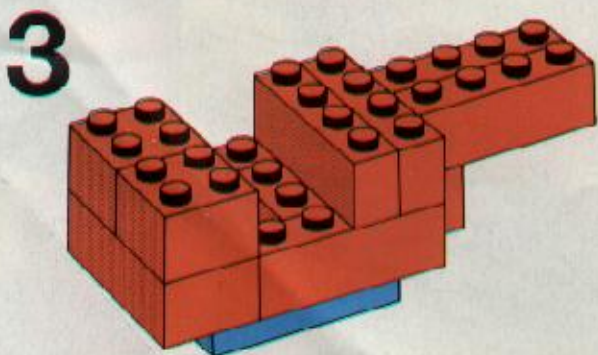
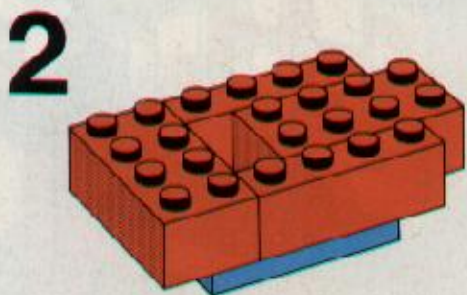
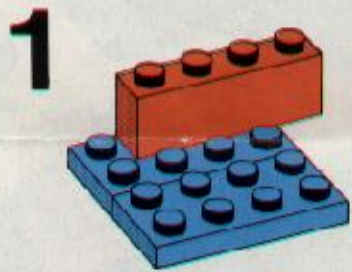
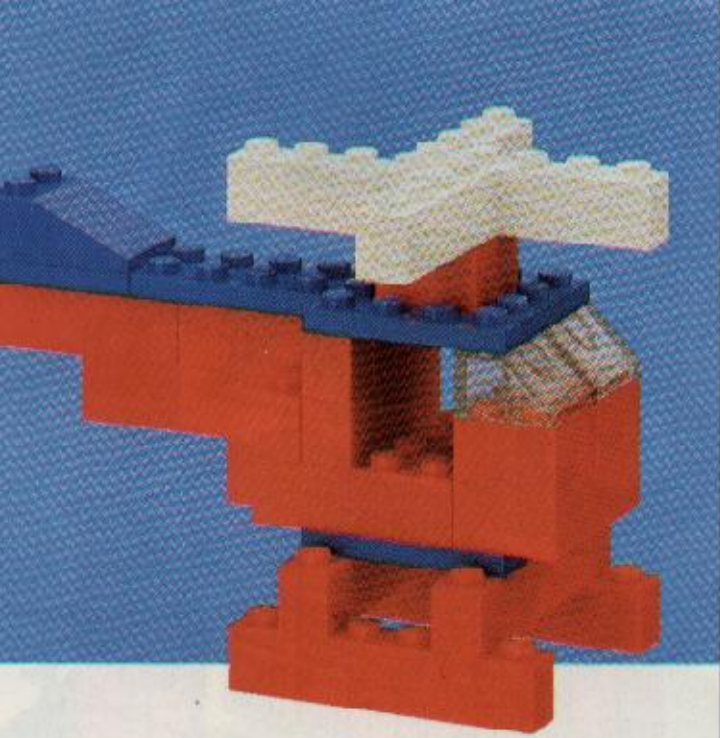

8

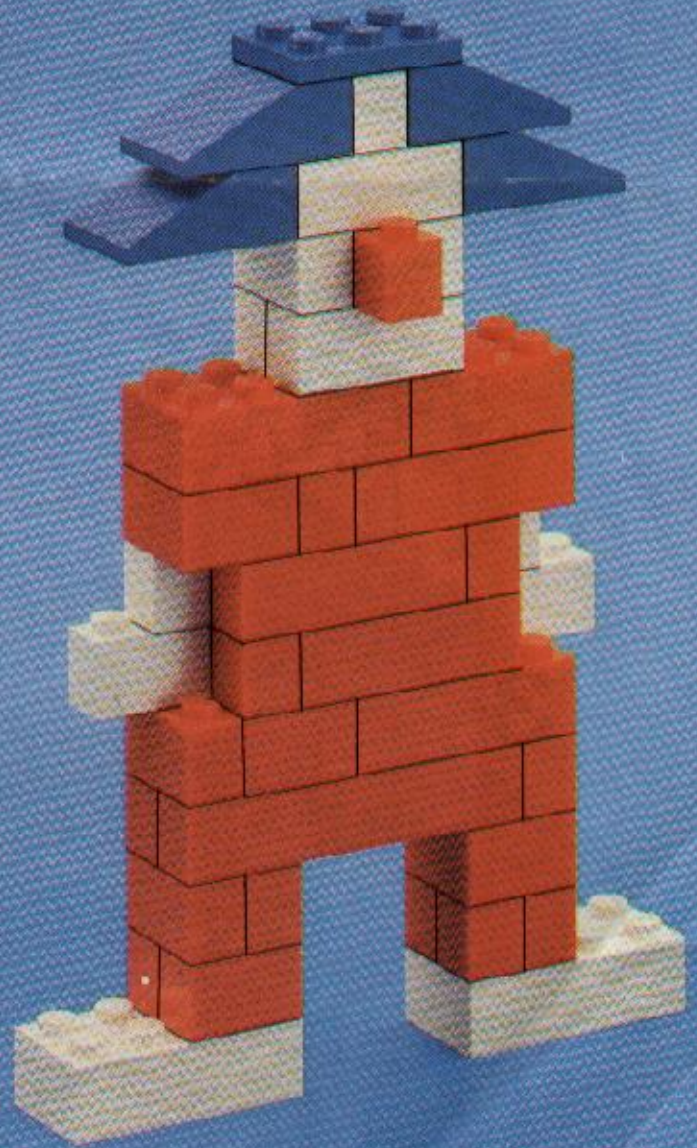
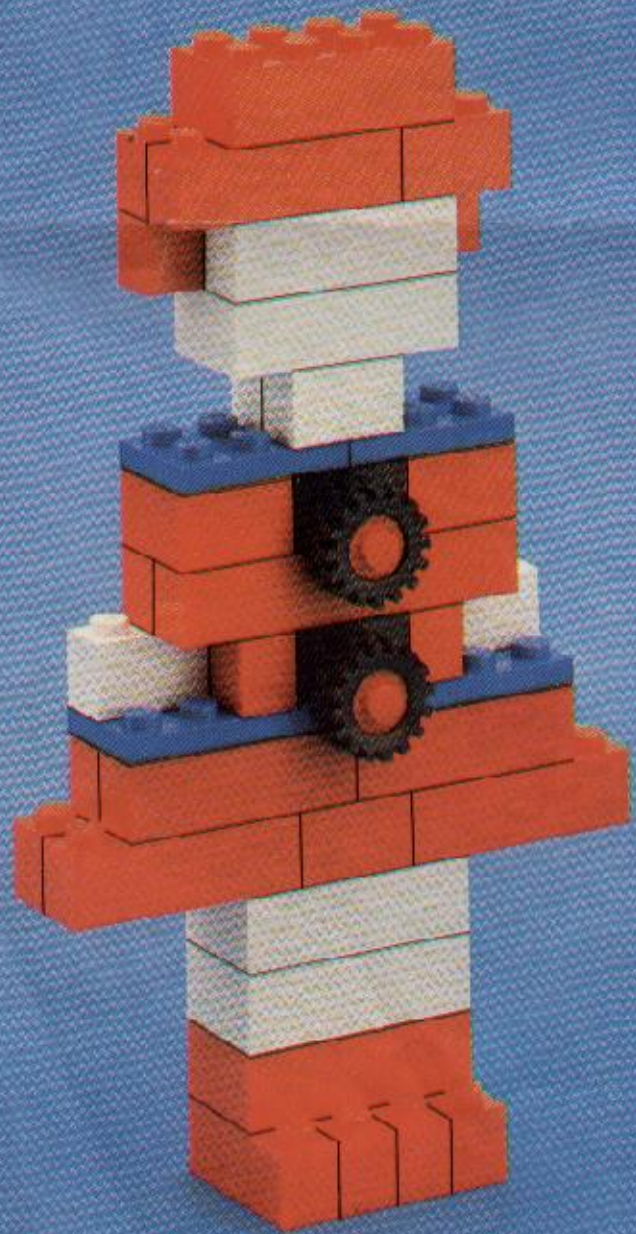
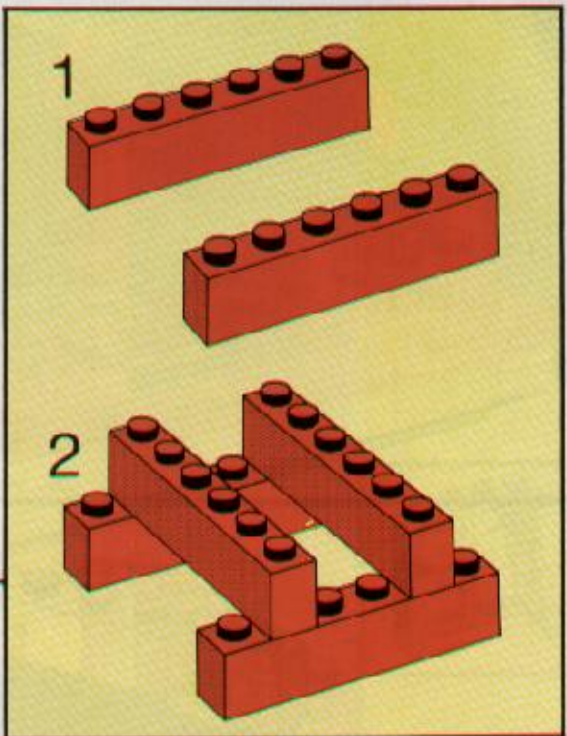
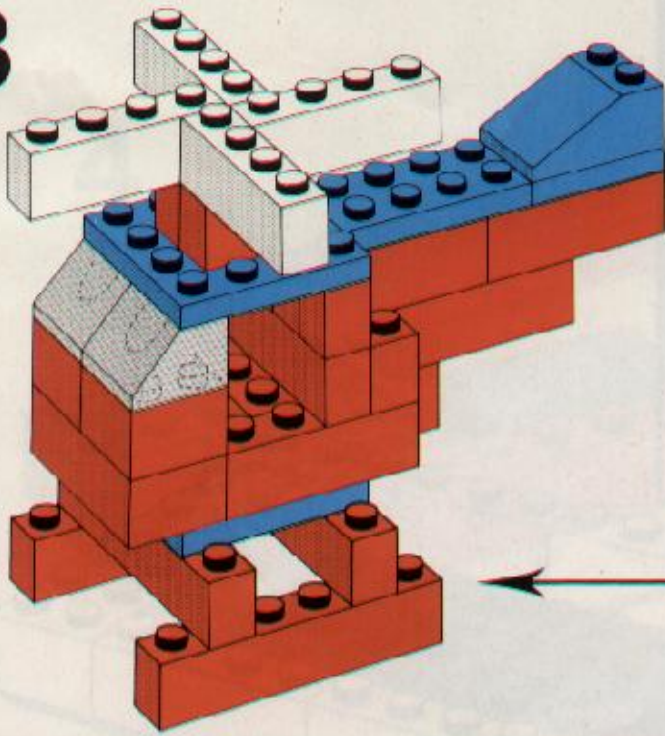



1

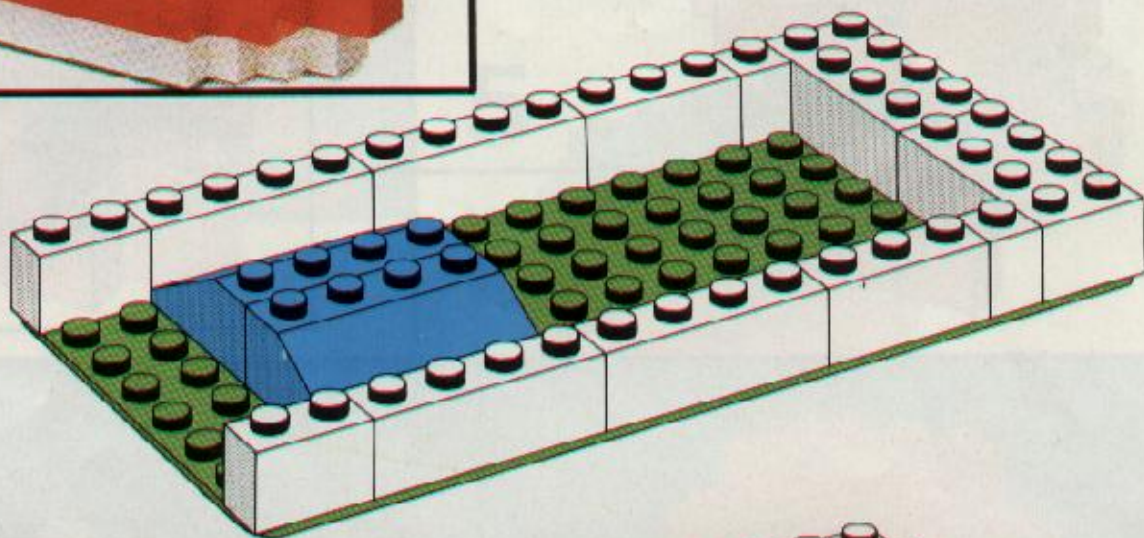

2

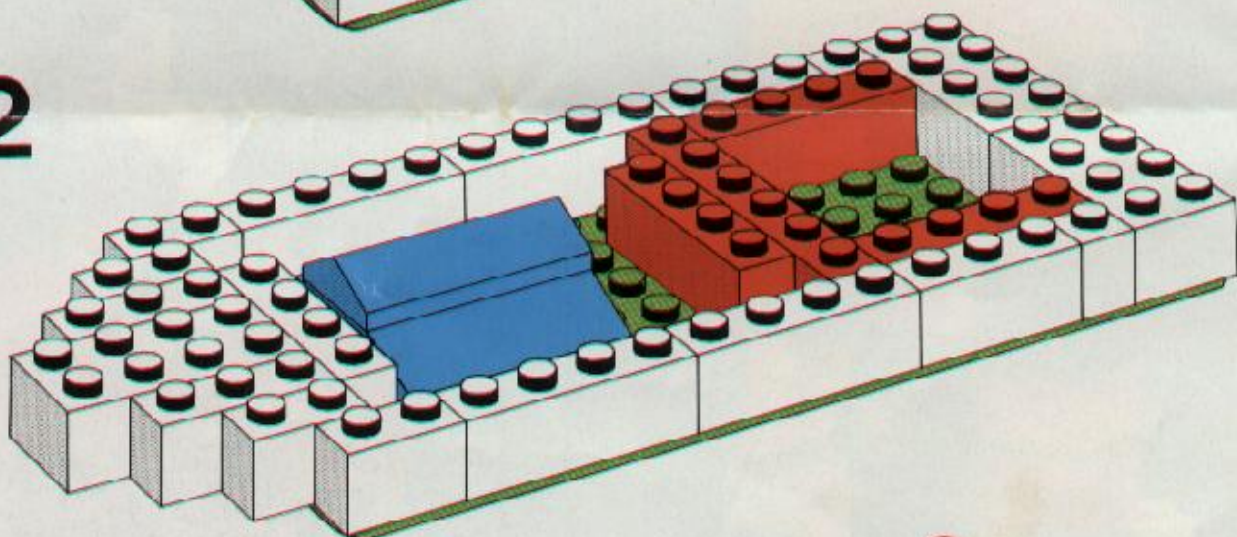

3

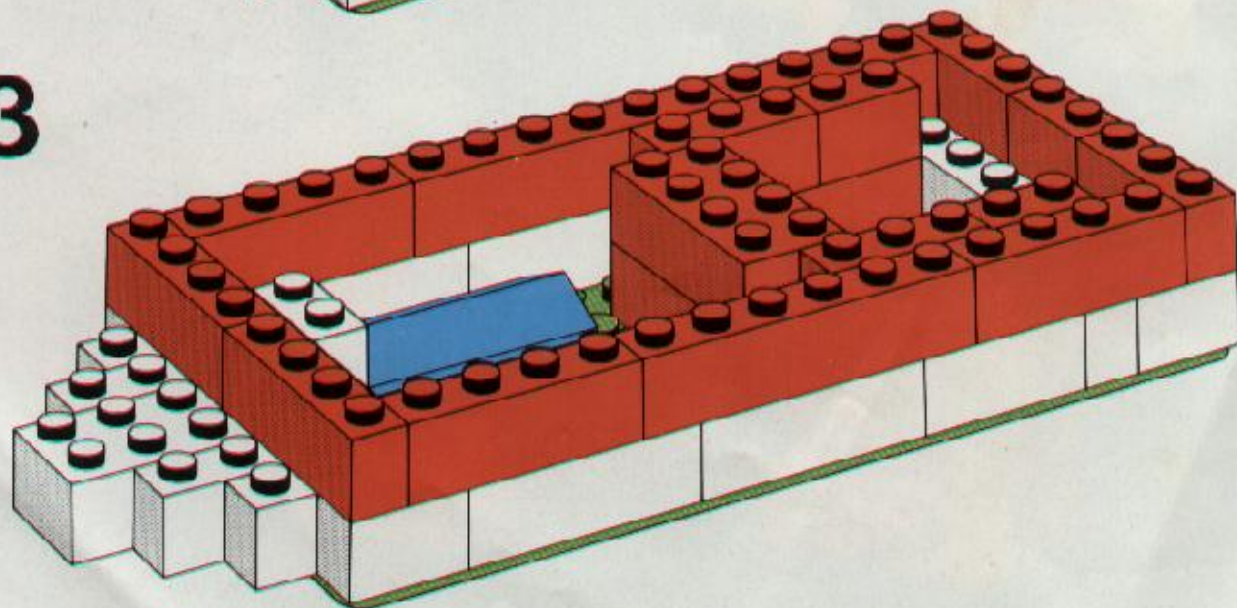



4

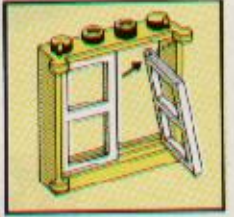
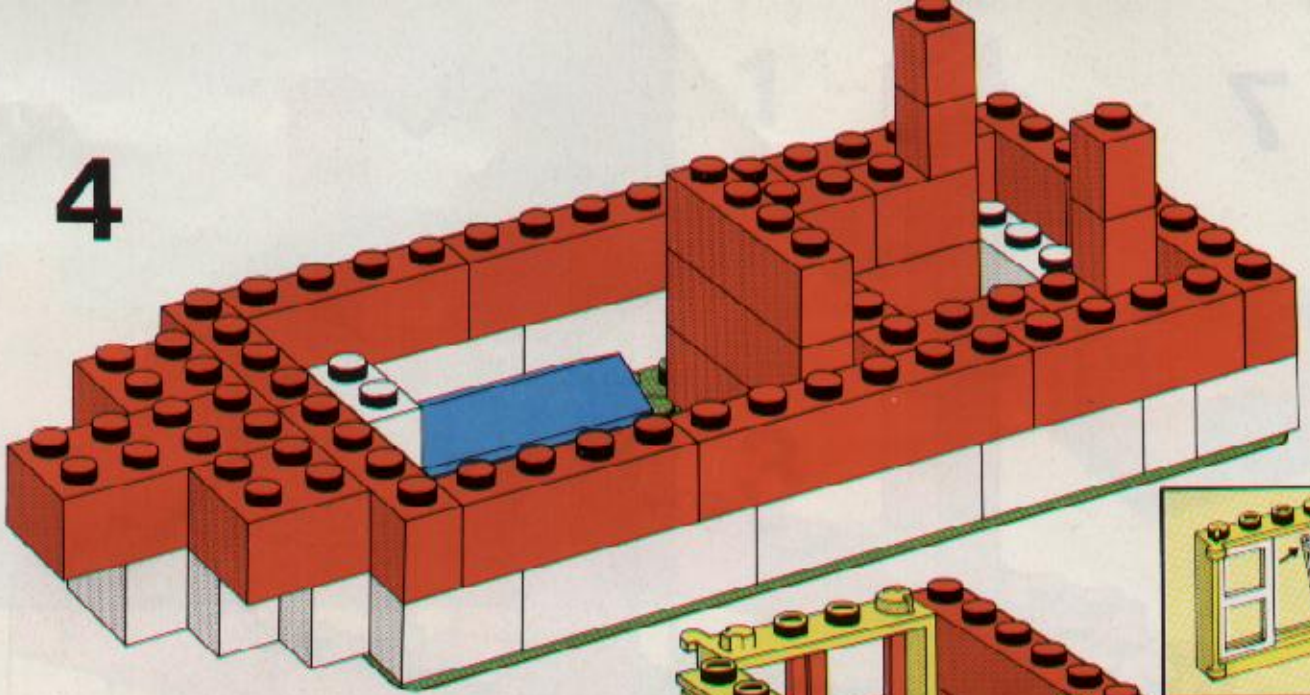

5

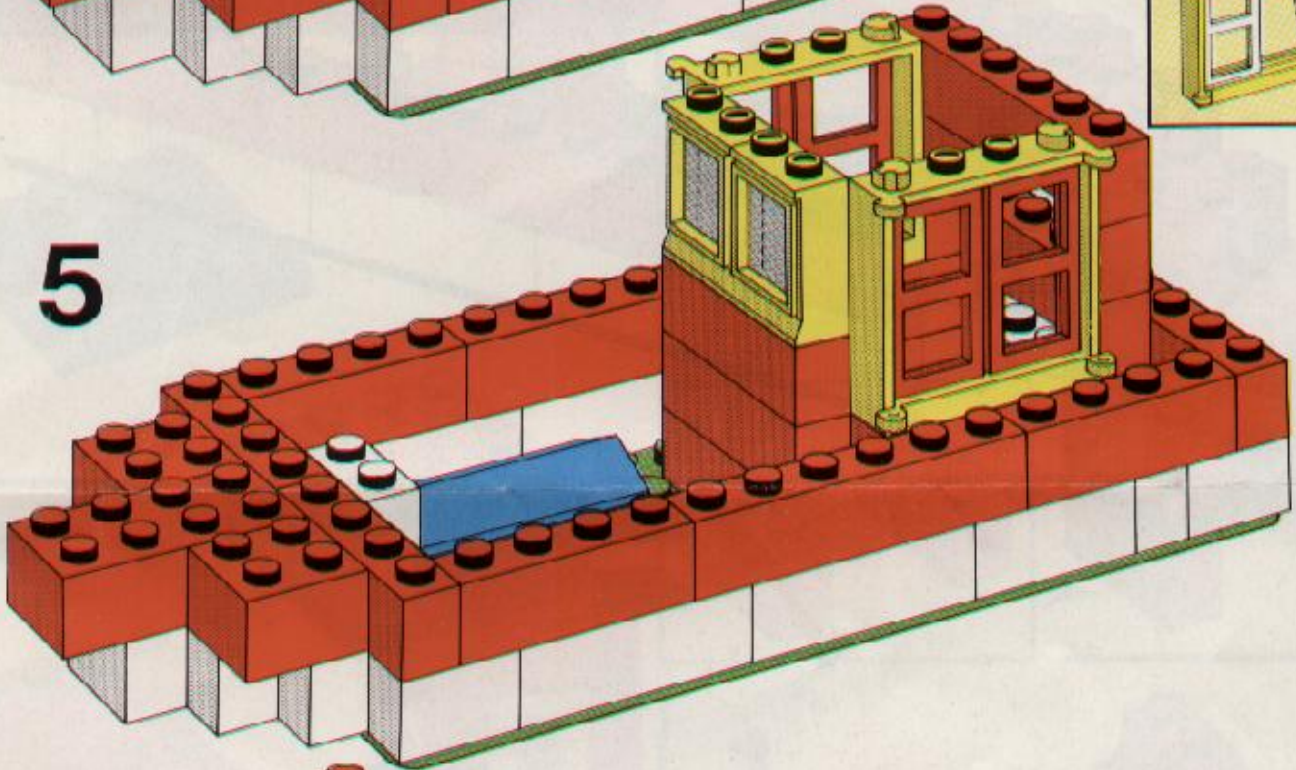

6

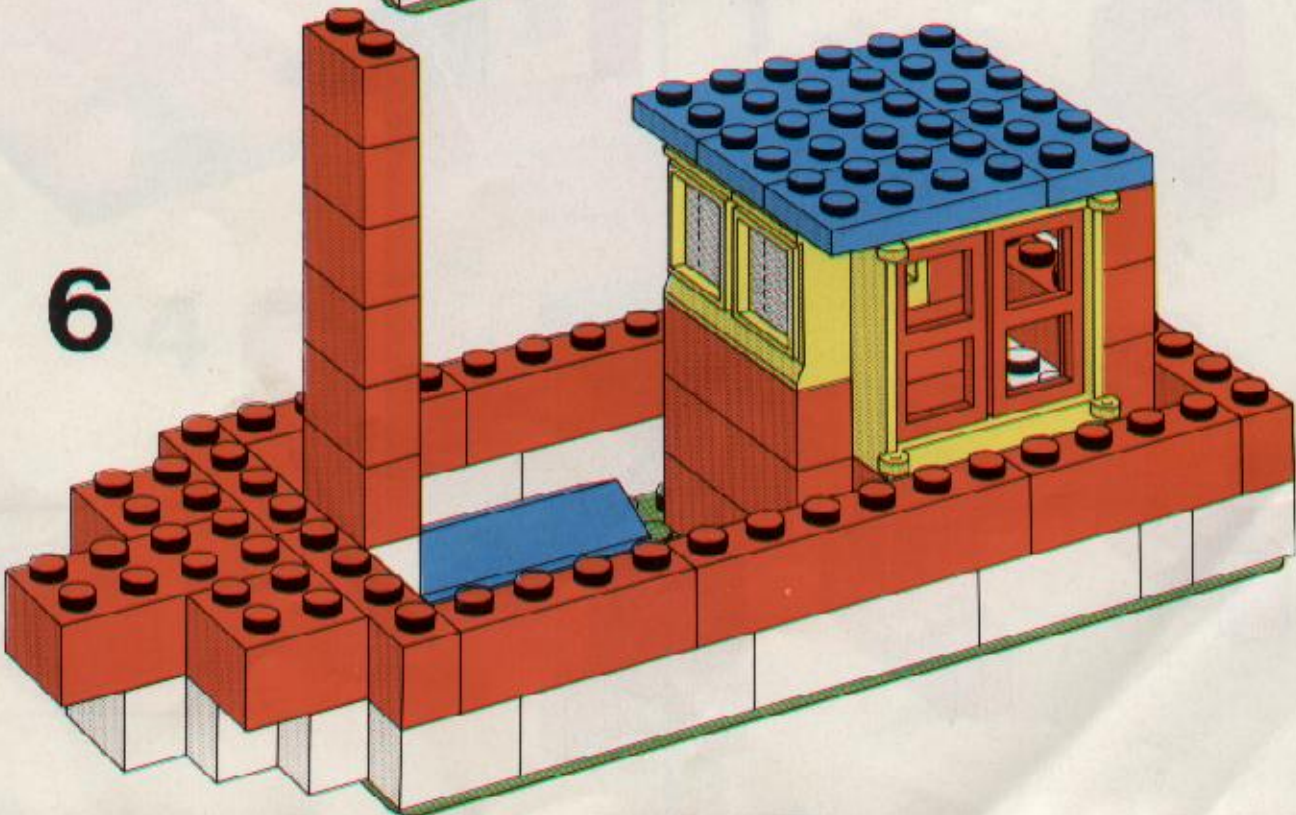

7

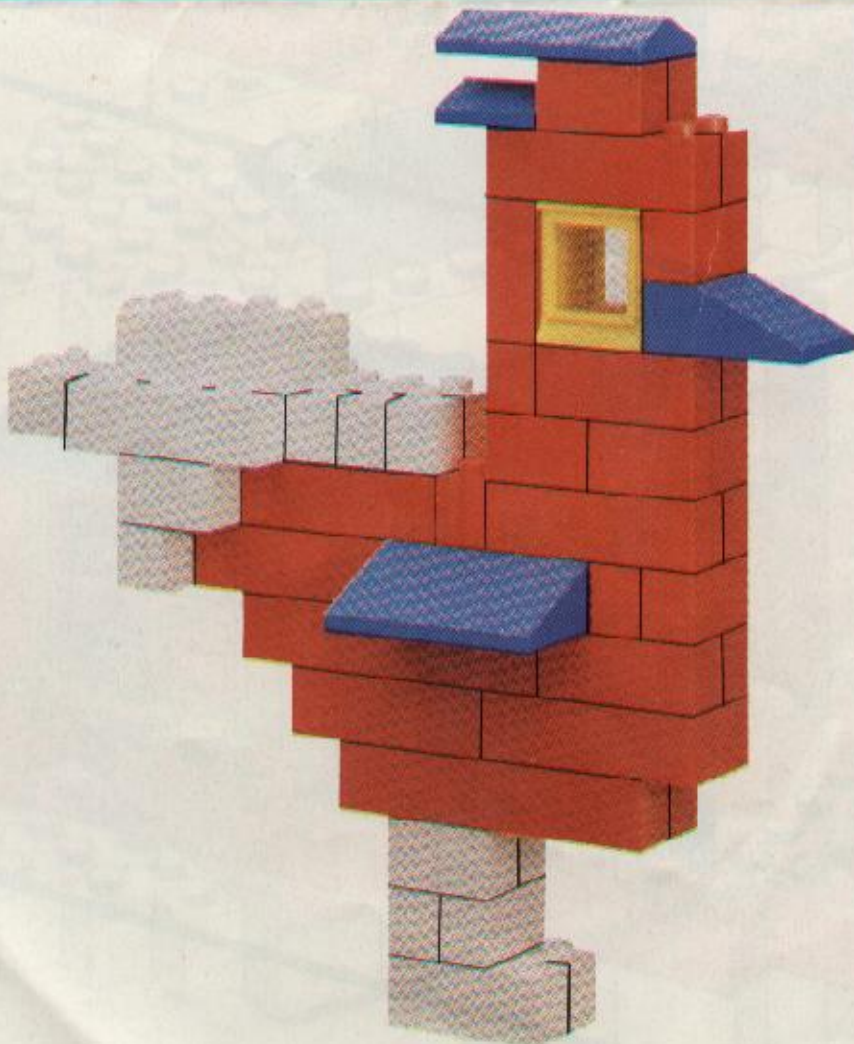
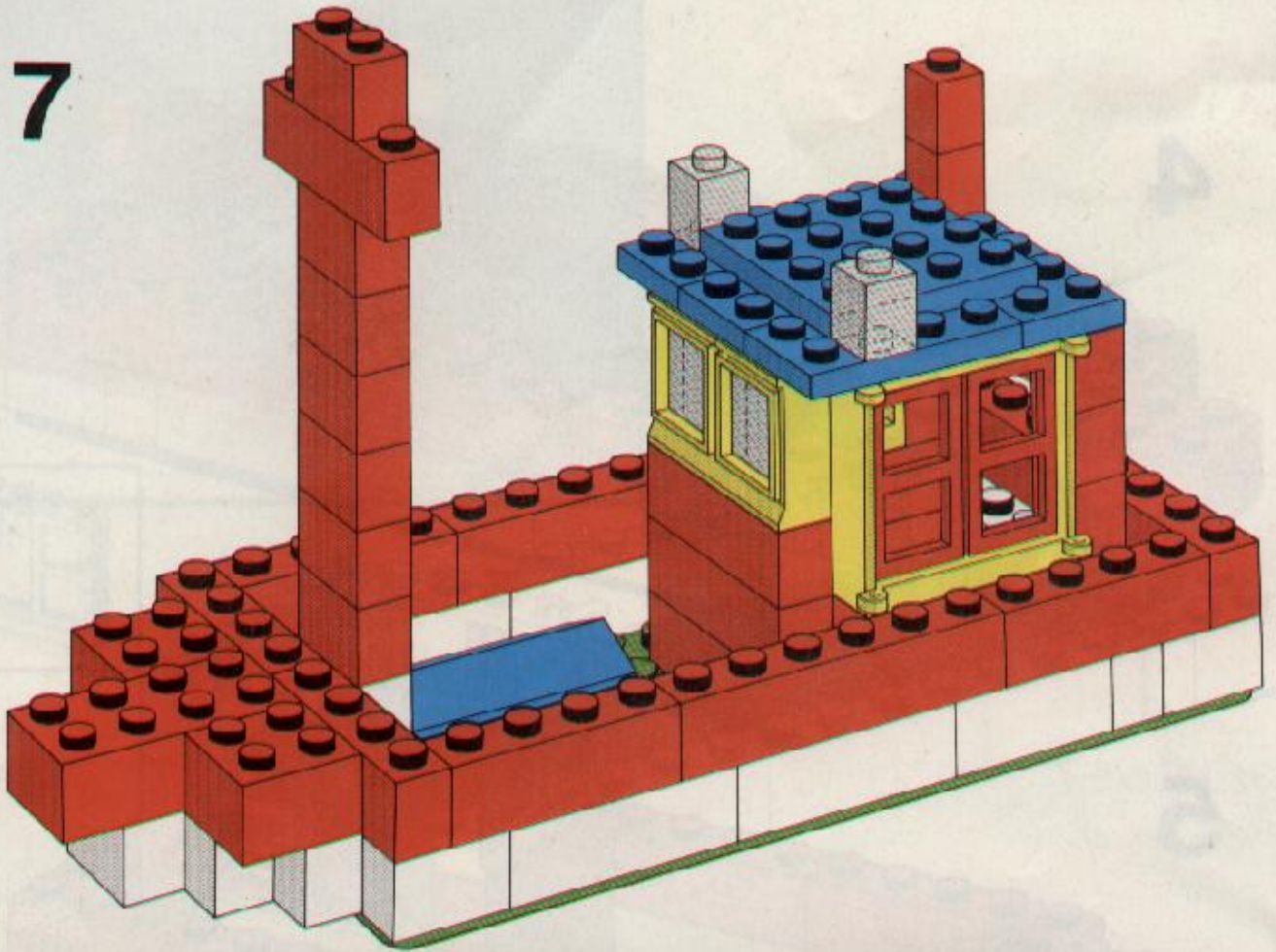

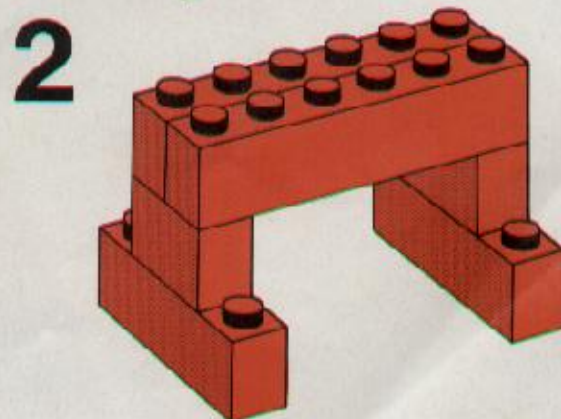
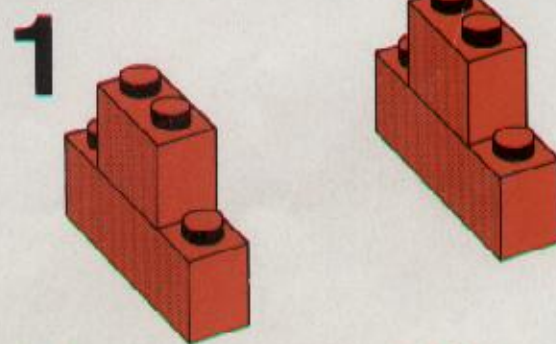
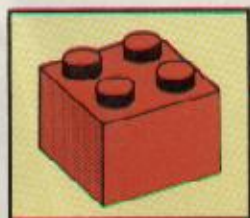
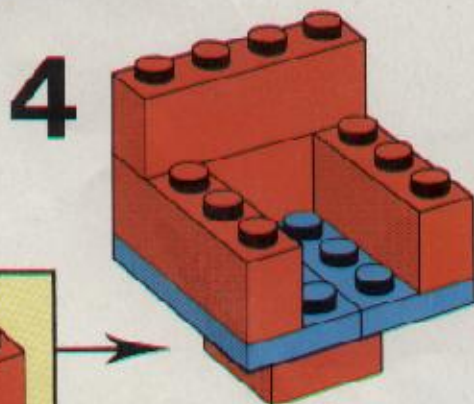
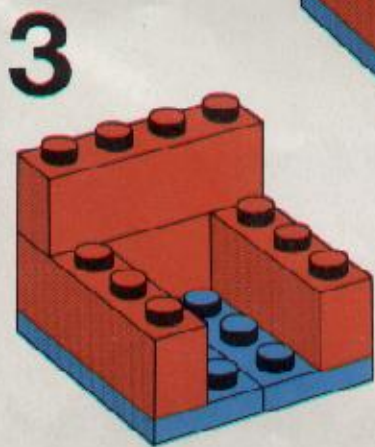
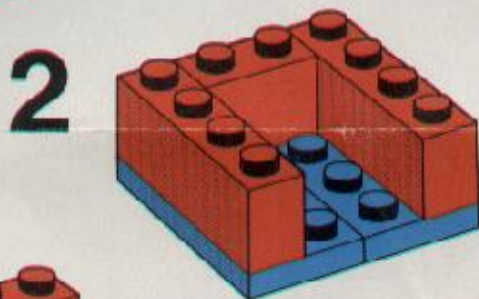
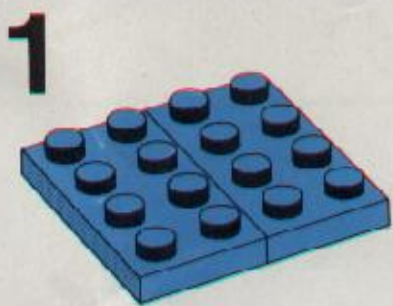
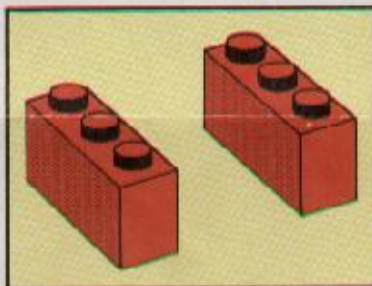
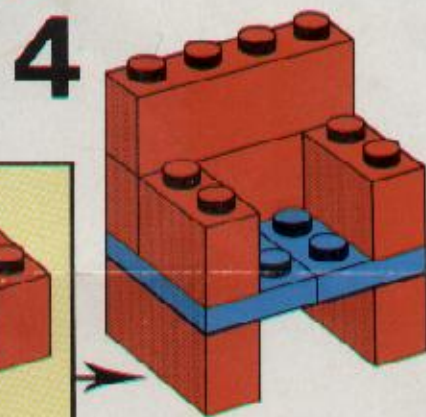
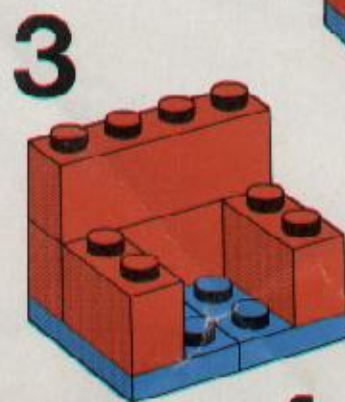
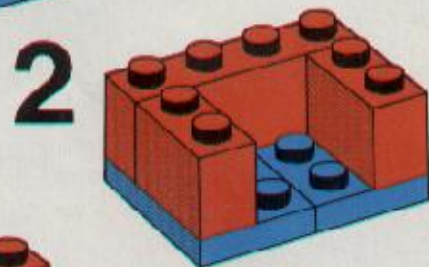
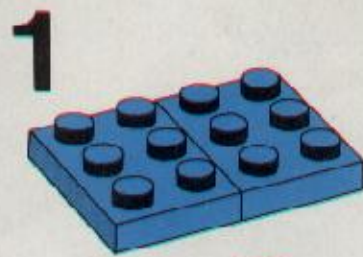
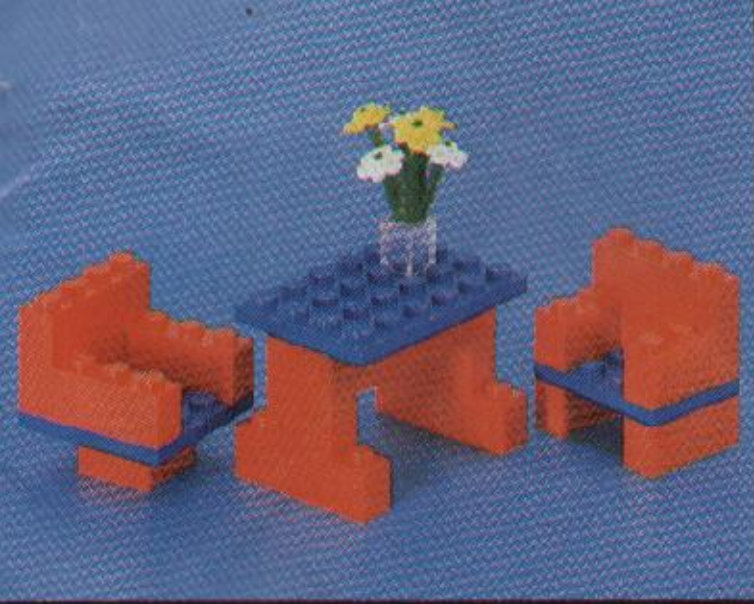

3

