



THE LORD OF THE RINGS

79006



1



2



3



4



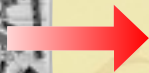
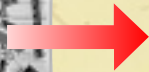

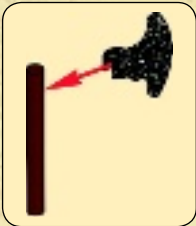

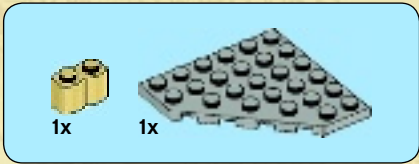
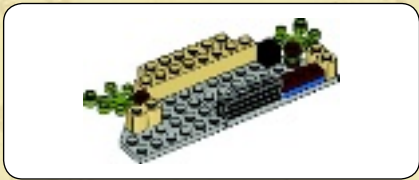

1



2



3





4

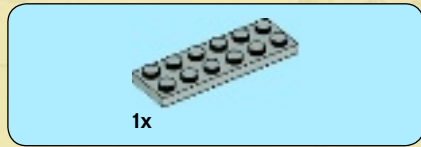
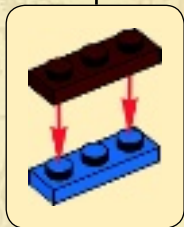

5

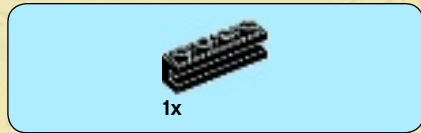

6



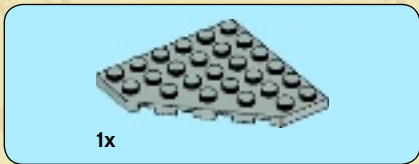

7

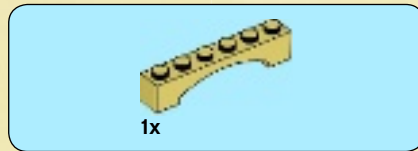
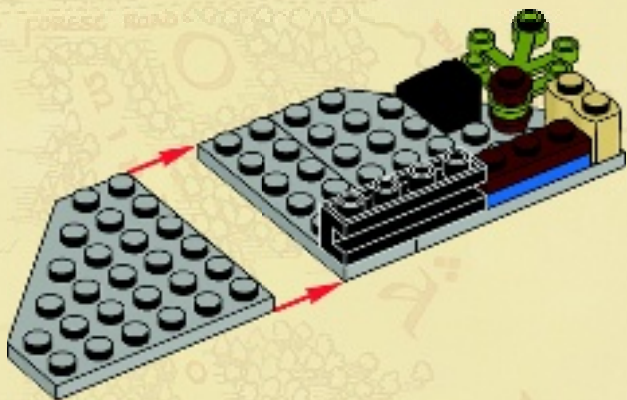

8

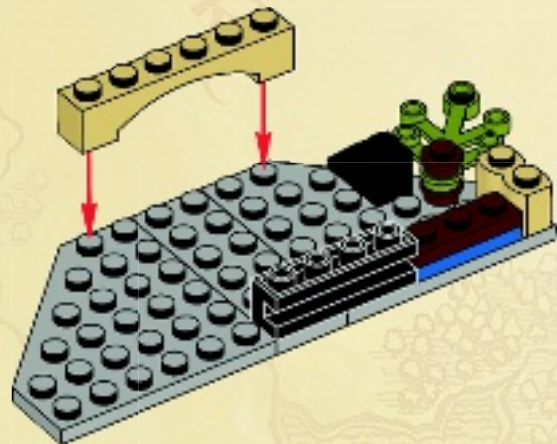

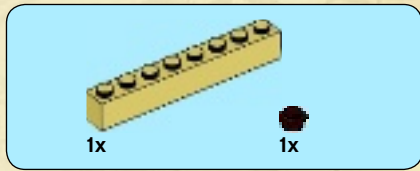

9

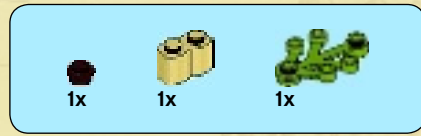
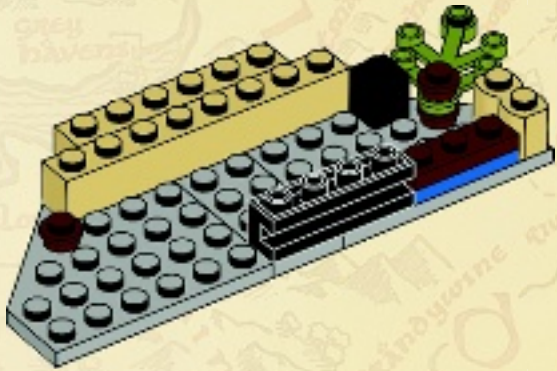

10

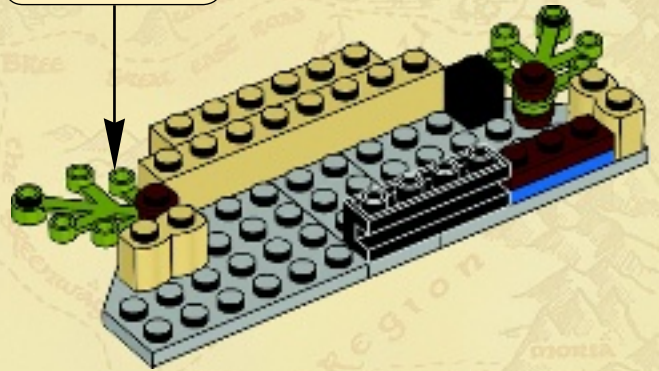
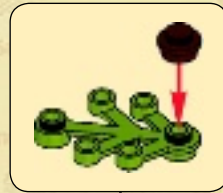

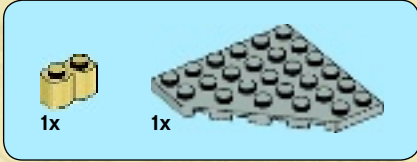
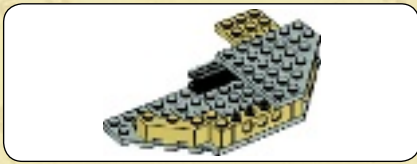

1

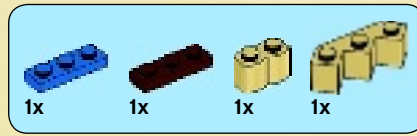

2

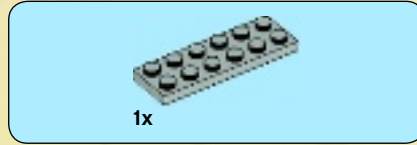
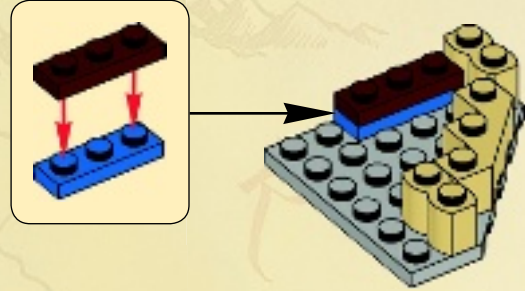

3

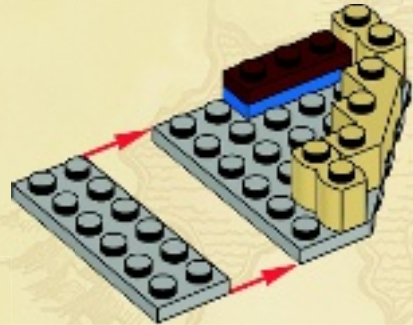



4

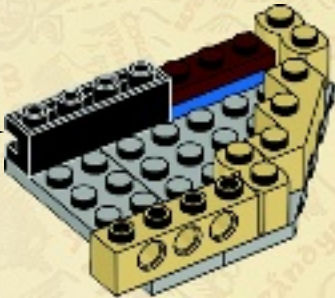
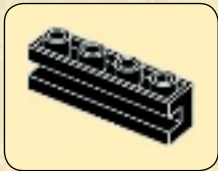

5

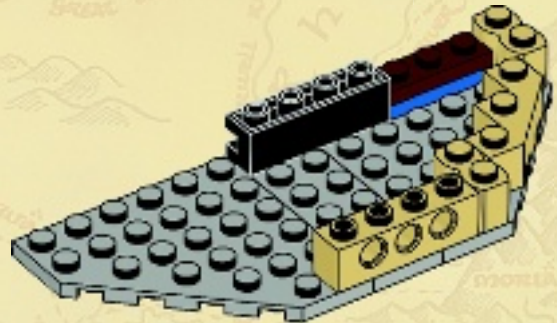



1x



1x

6

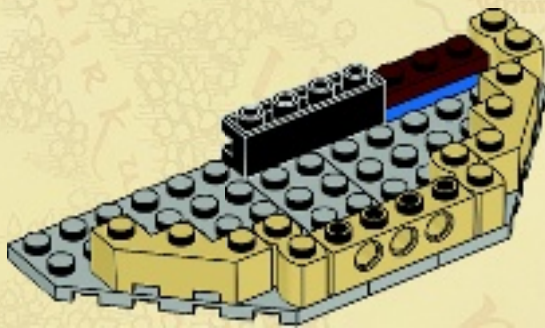

3x

7

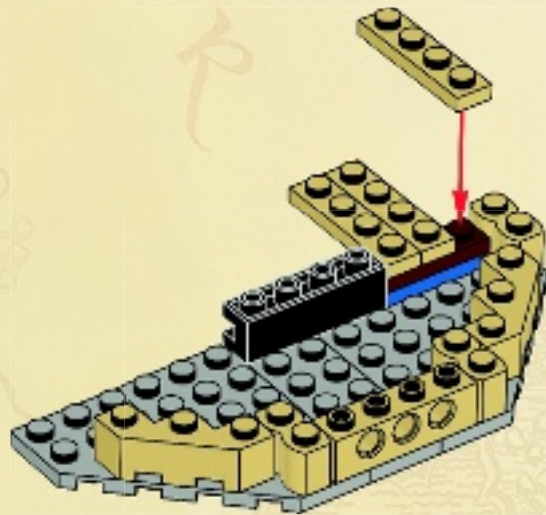



8

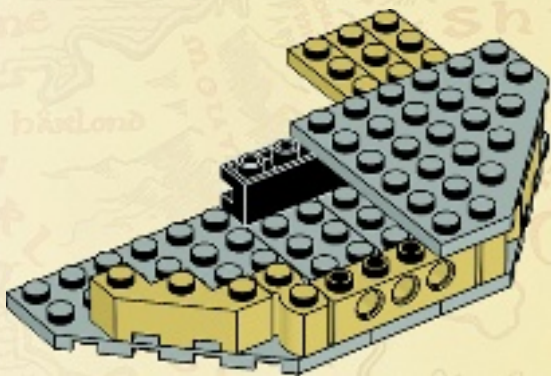

11

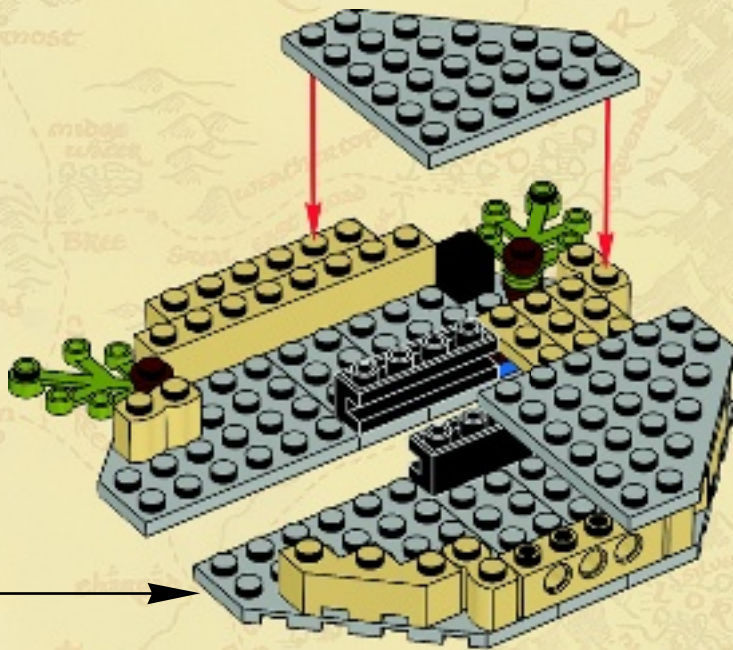

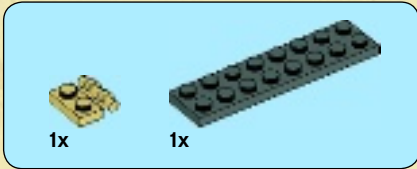
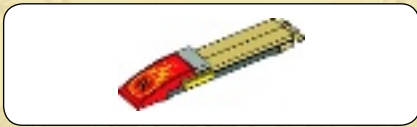

1

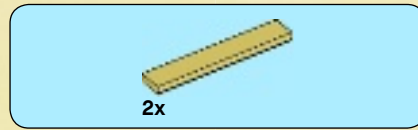
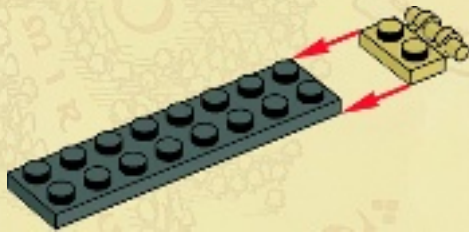

2x

2

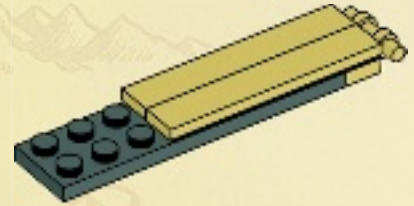

2x

3



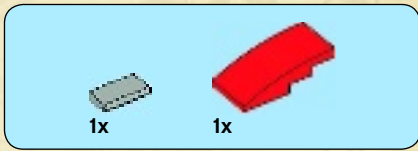

4

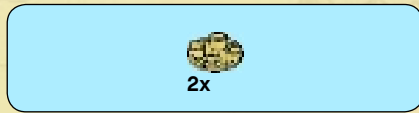
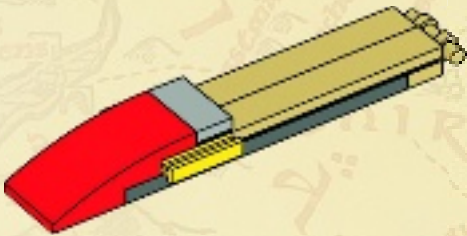

5

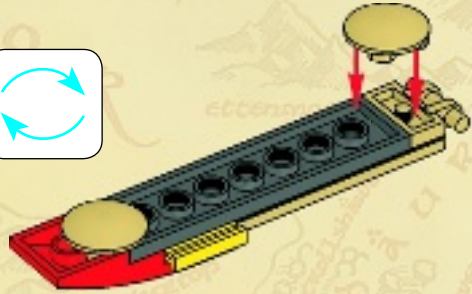
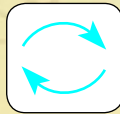

6

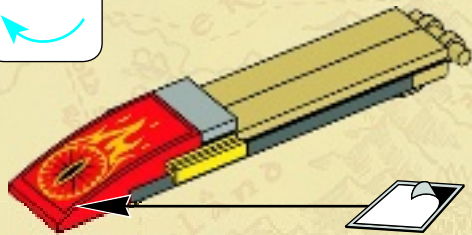
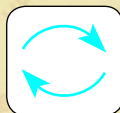

12

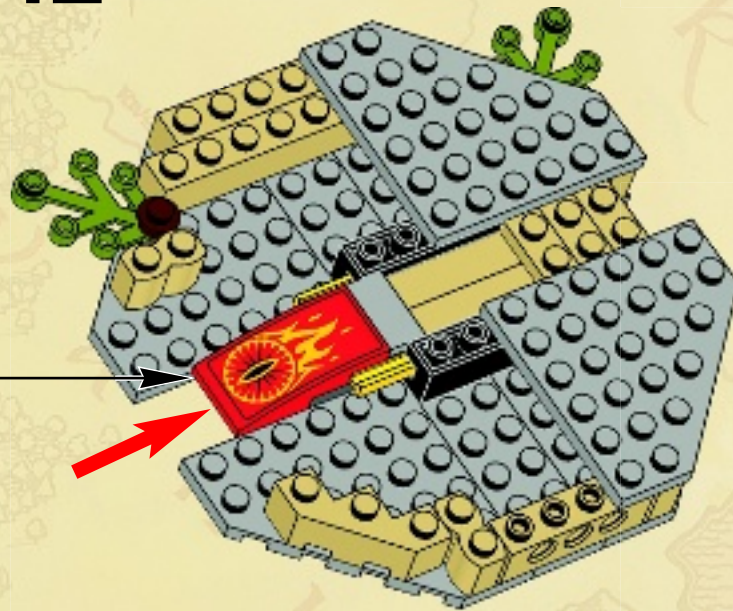



2x

13

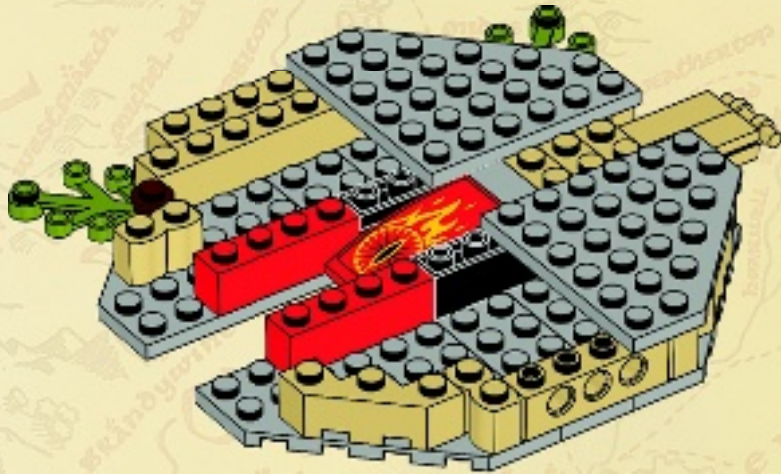

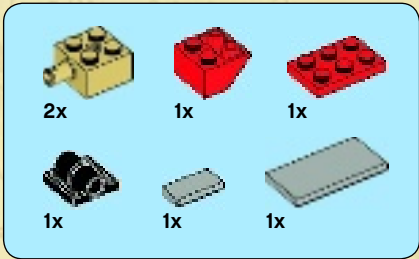

14

1



2

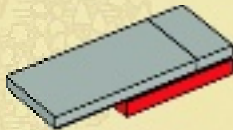

3

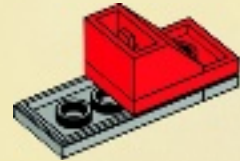
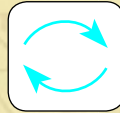

4



5

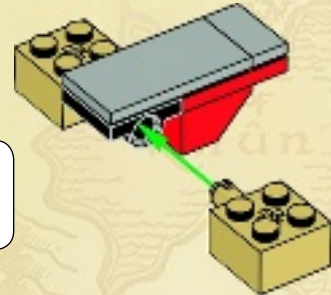
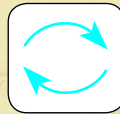

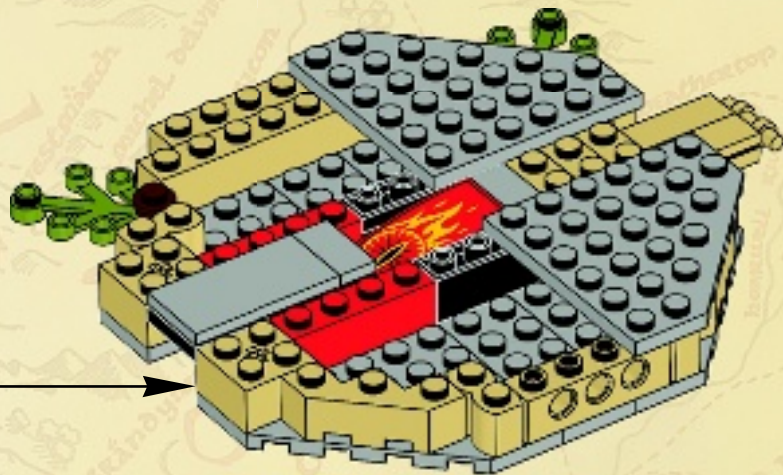

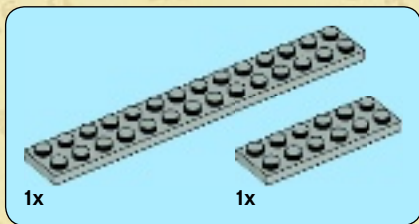

15

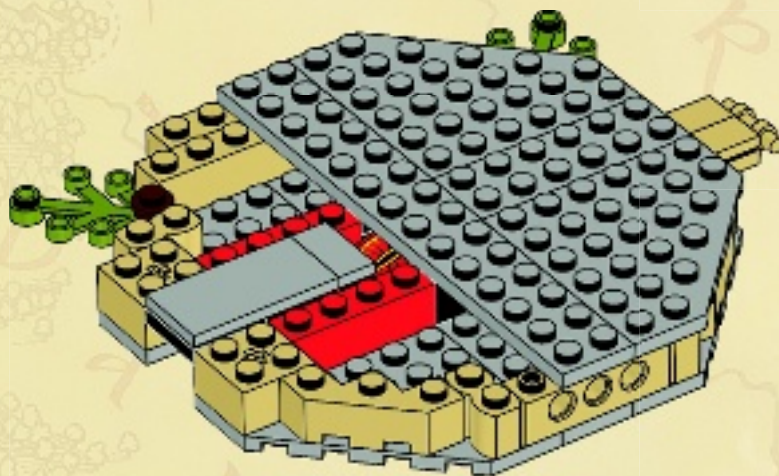



16

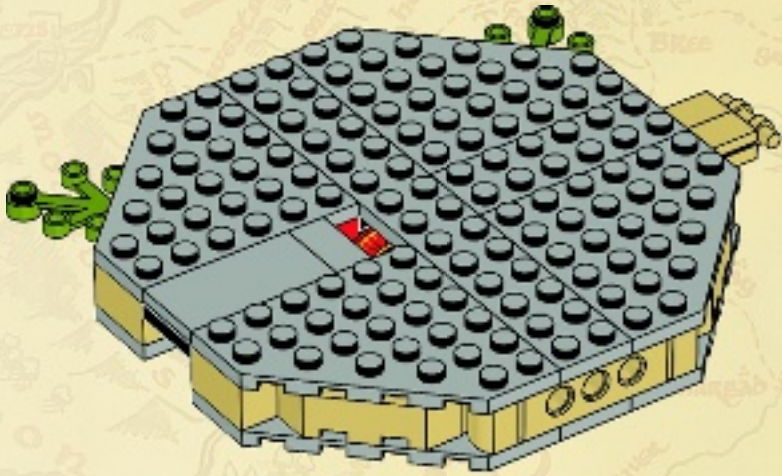
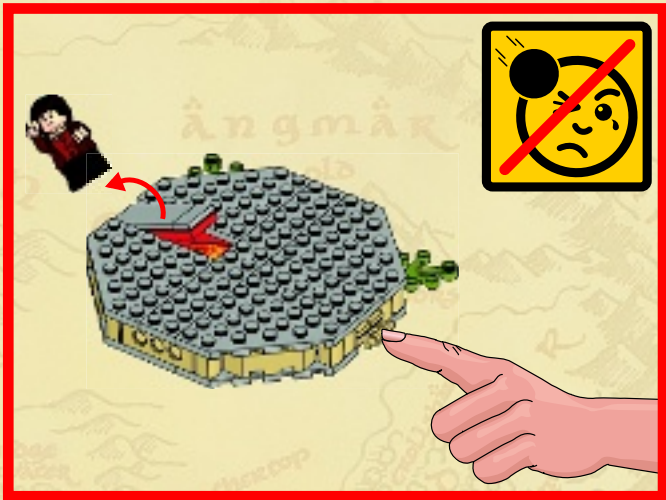



17

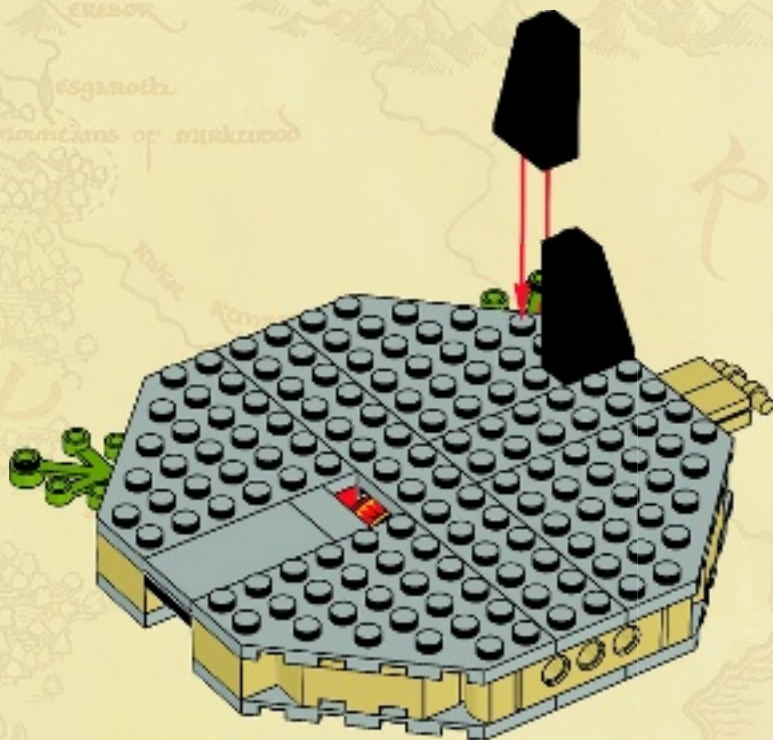



18

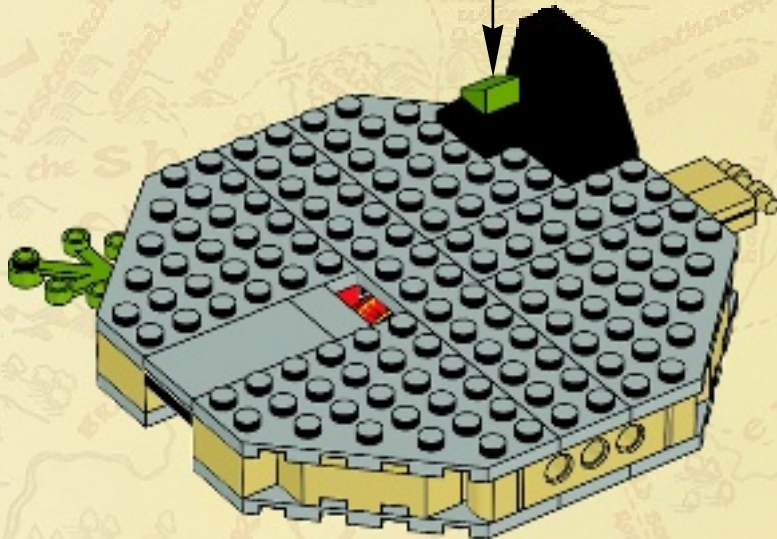
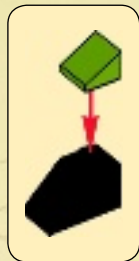



19

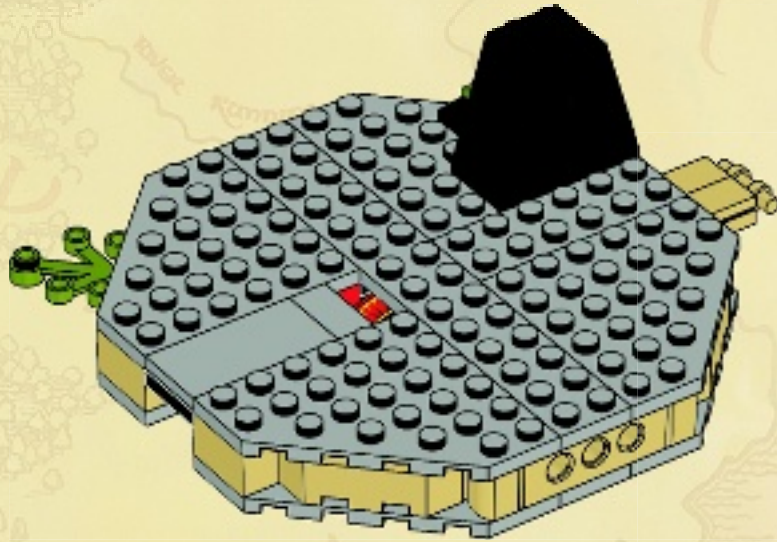



3x



1x

20

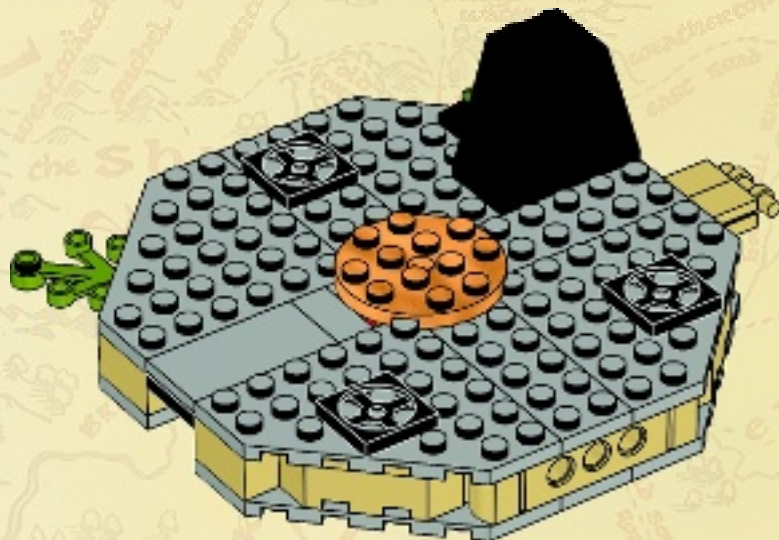



3x



4x

21

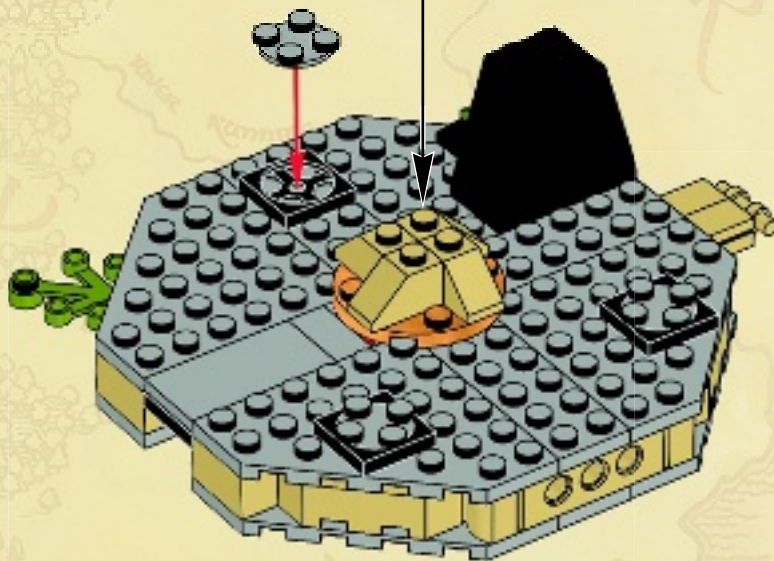
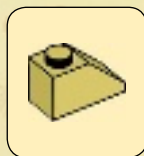



4x



1x

22

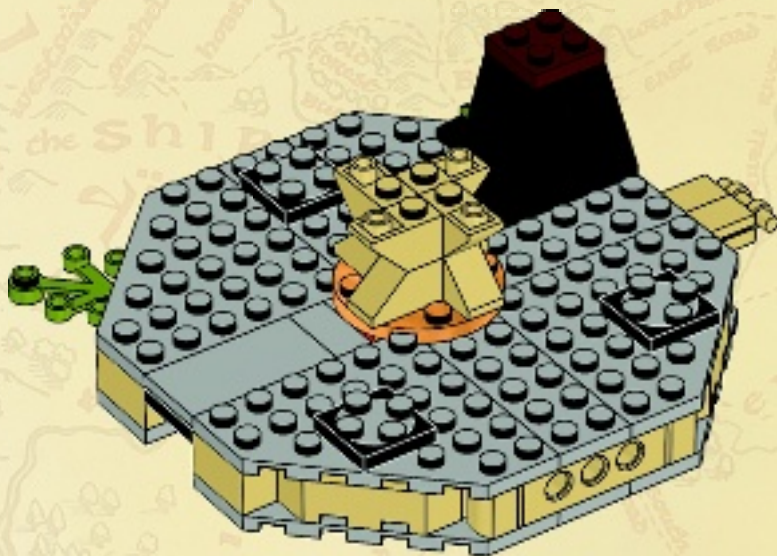



23

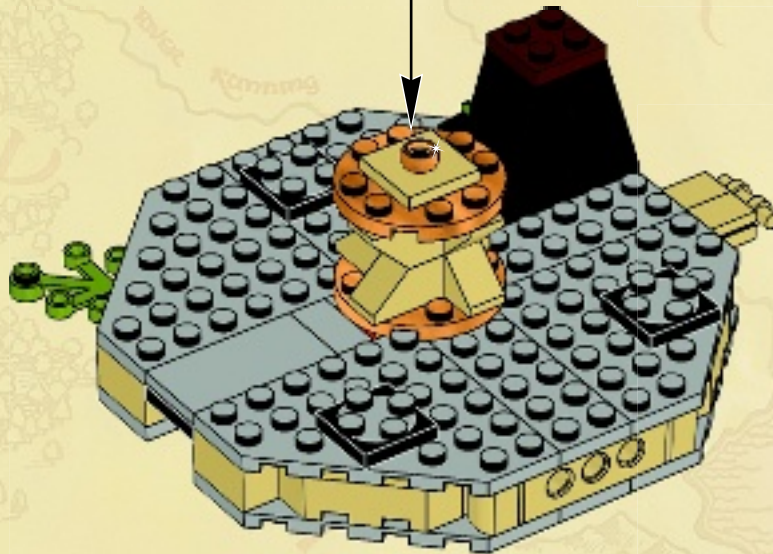

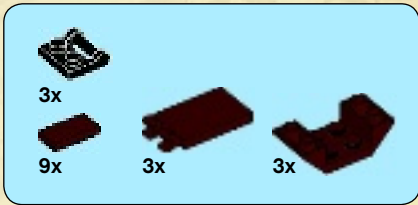

24

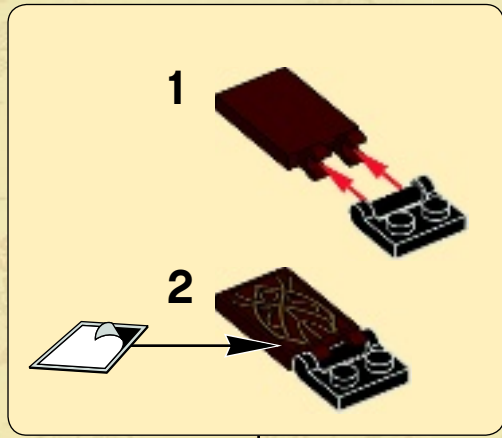

3x



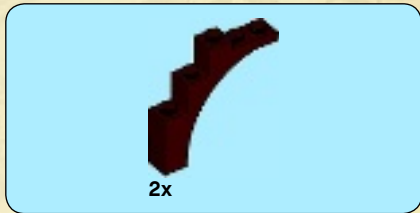

25





1x



1x

26





27





1x



1x

28





1x



2x

29





3x

30



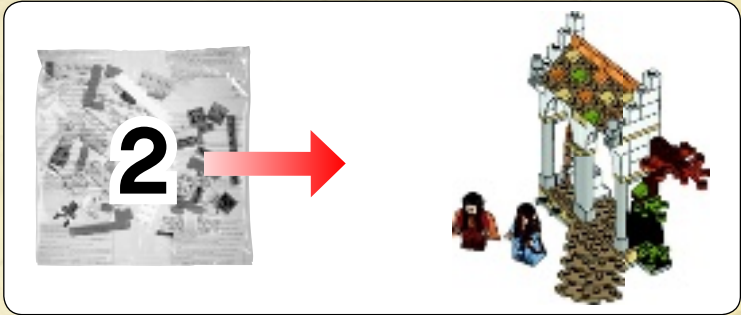

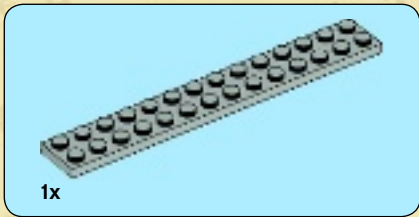

1

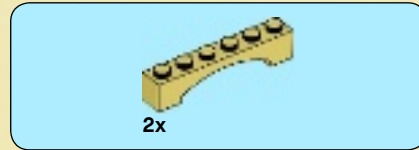
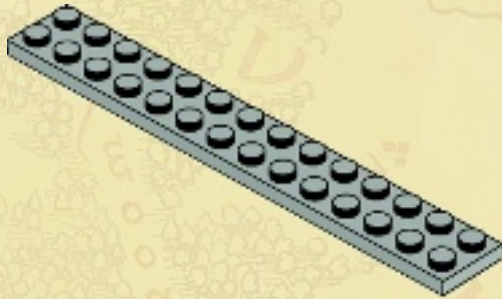

2

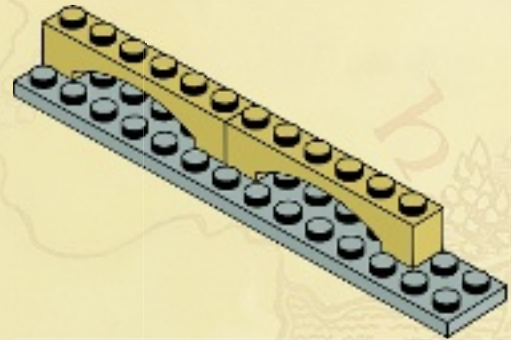

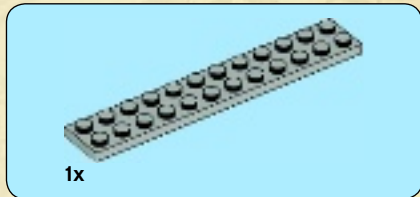

3

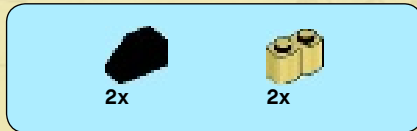
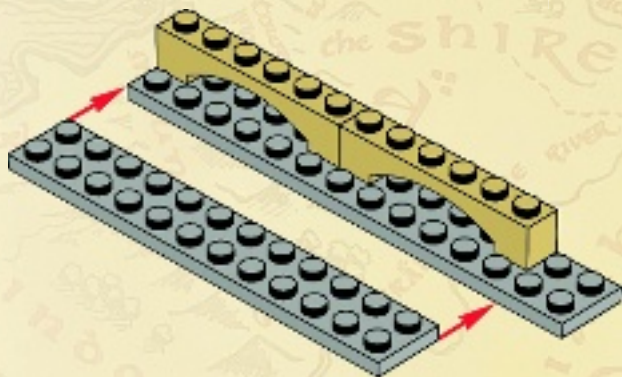

4

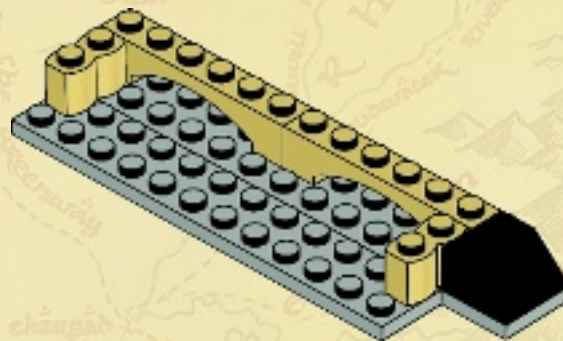

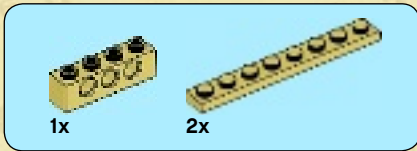

5

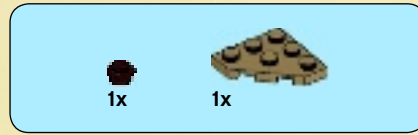
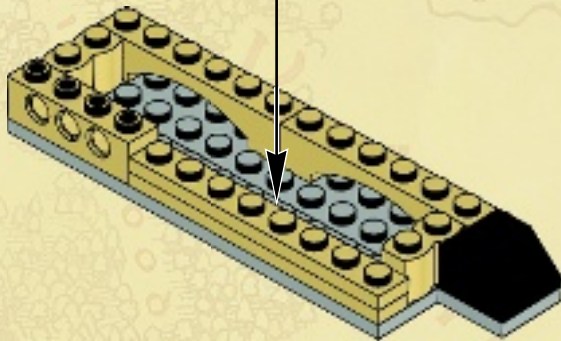
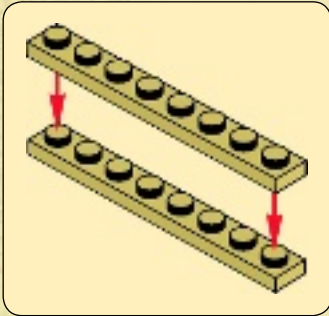

6

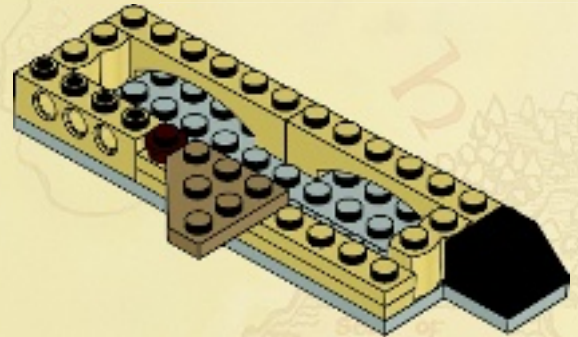

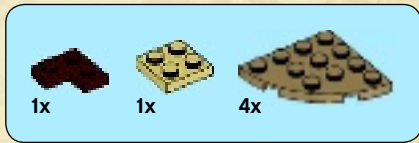

7

1



2



3

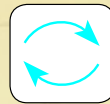

4

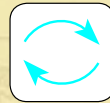

5



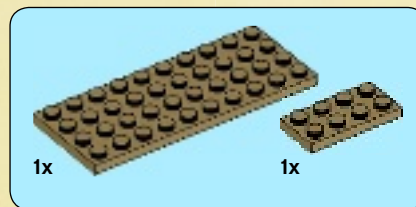
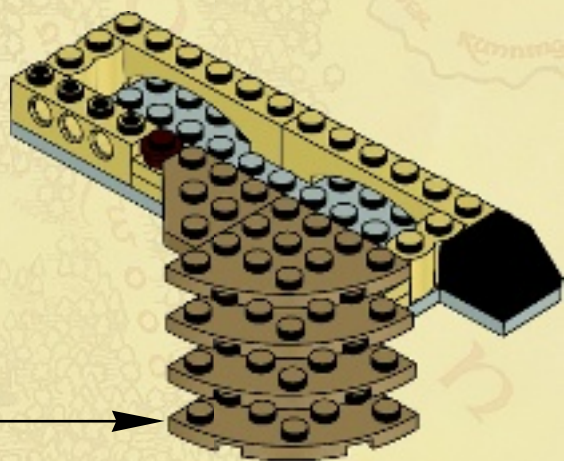

8

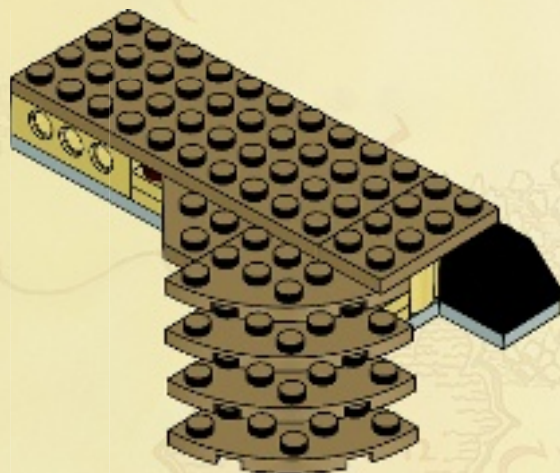

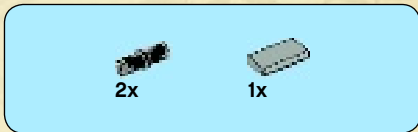

9

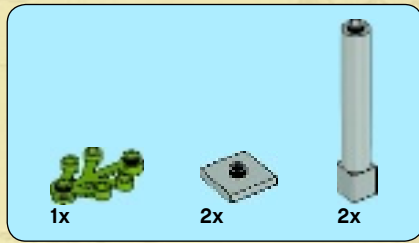
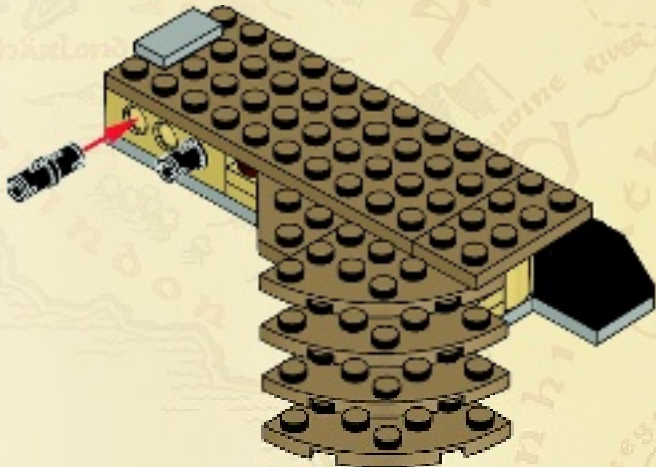

10



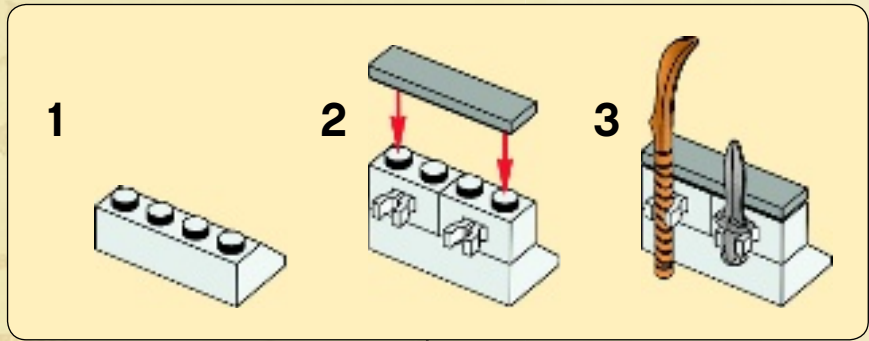
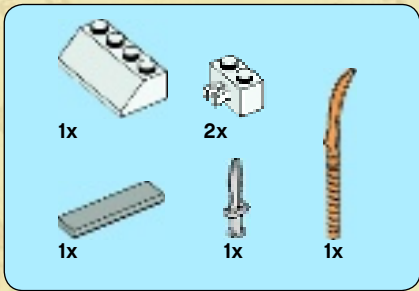

11

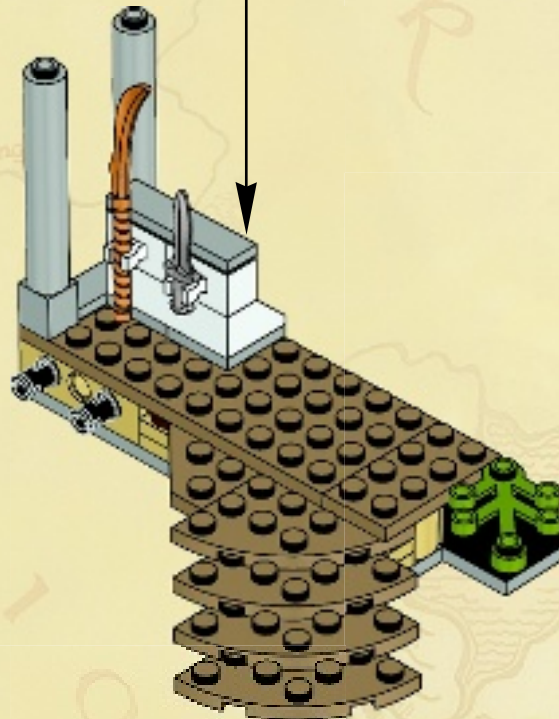



2x

12





13



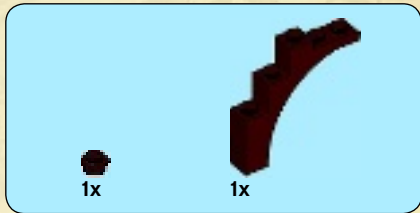

14

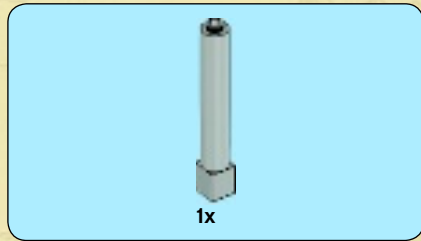

15





16

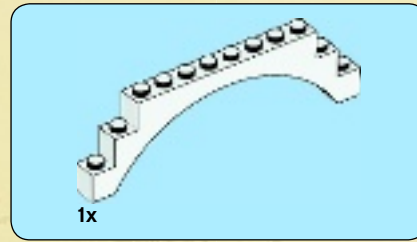
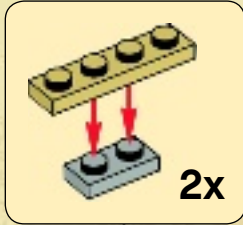

17





2x



1x

18



1x



1x

19





1x

20

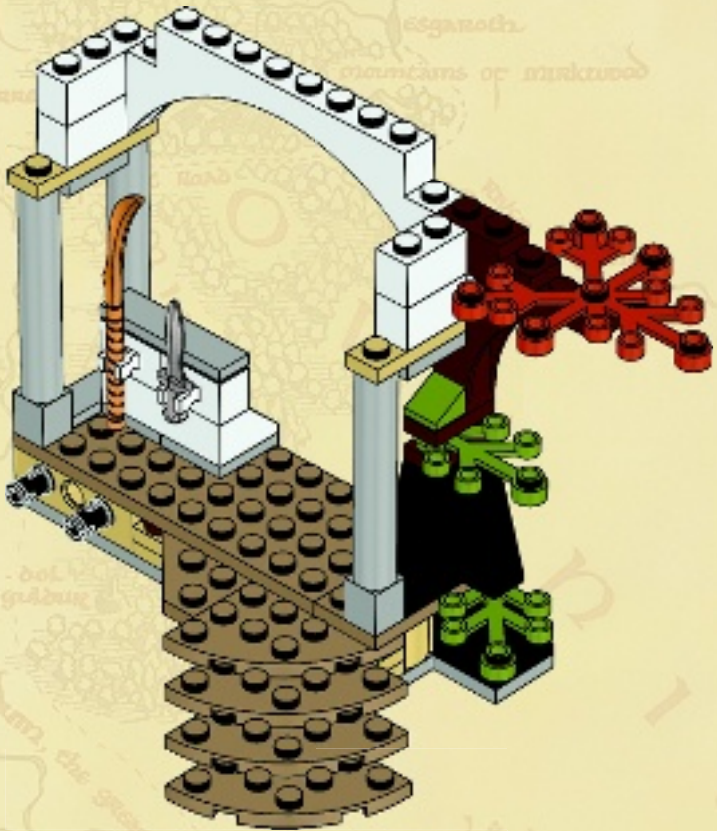

1x

21

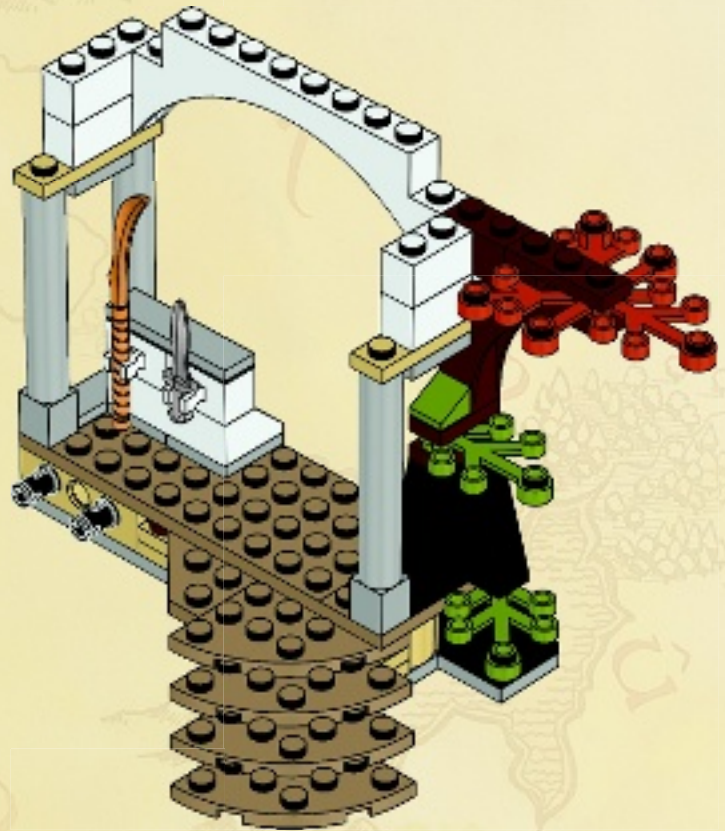



2x

22

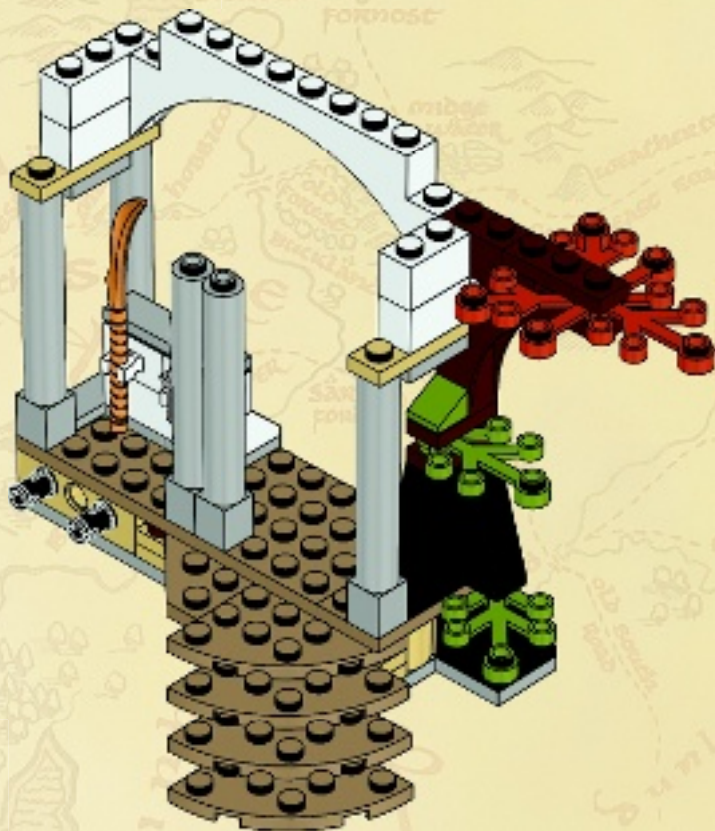



1x

23

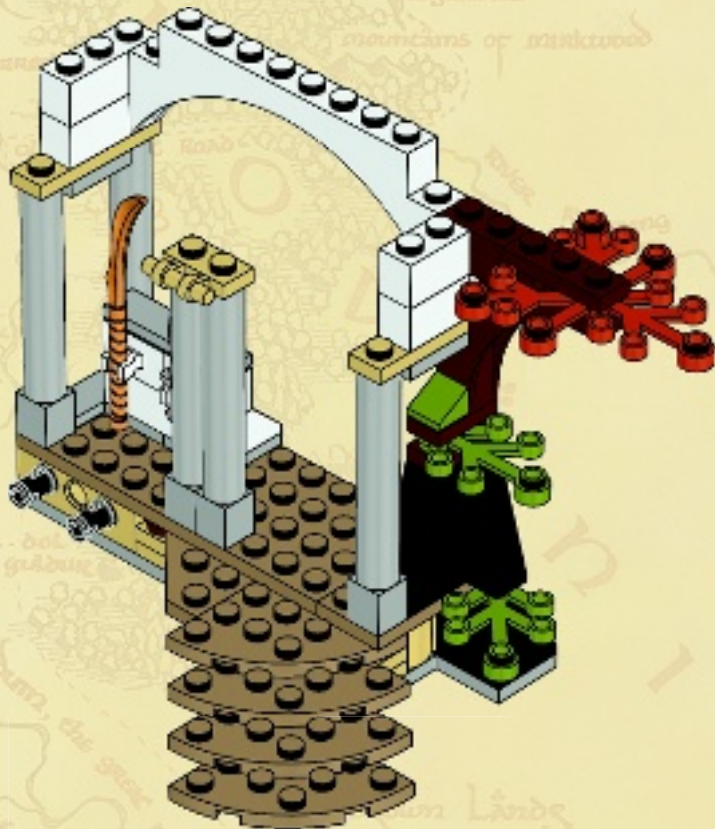

4x

24

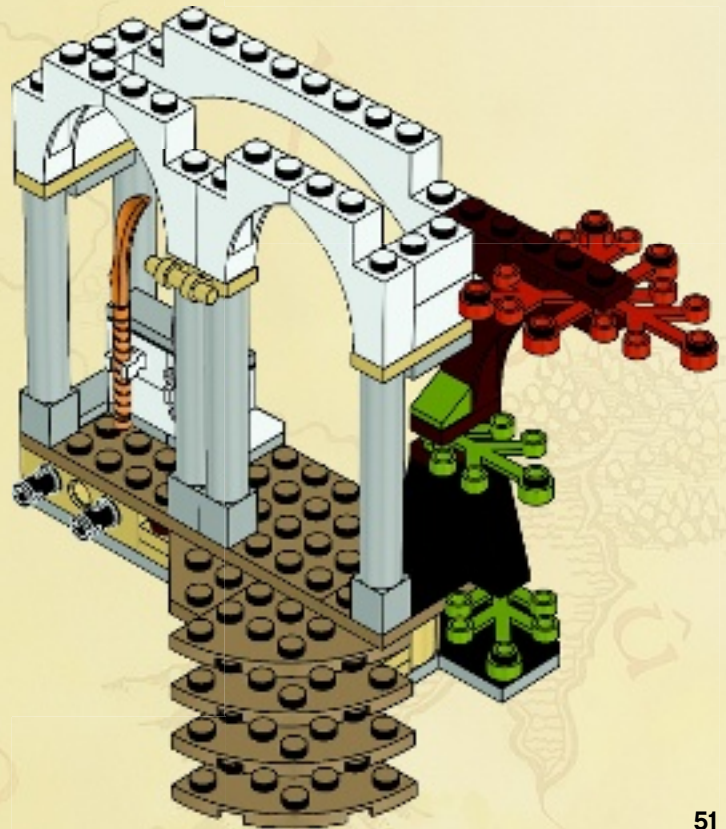



4x



2x



1x

25



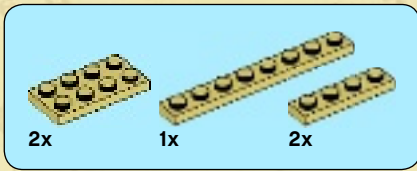

26





27

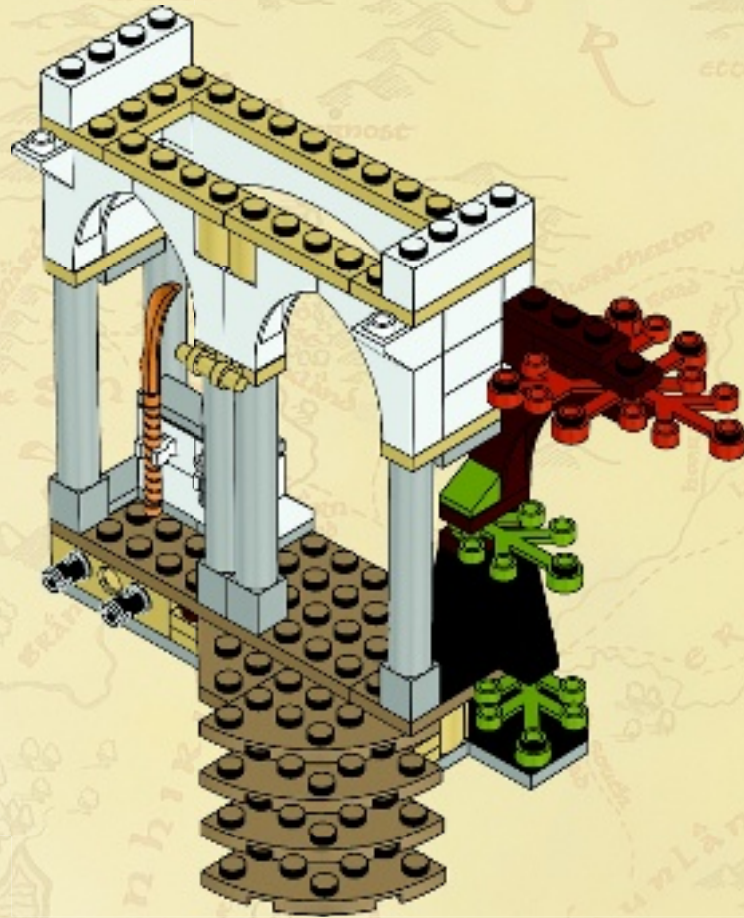

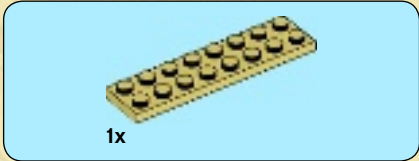

1

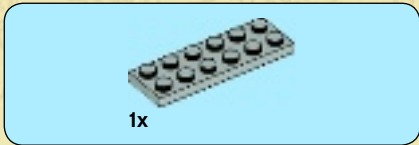

2



3

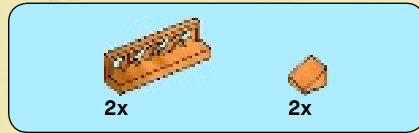
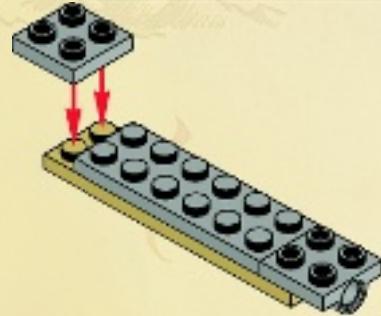

4

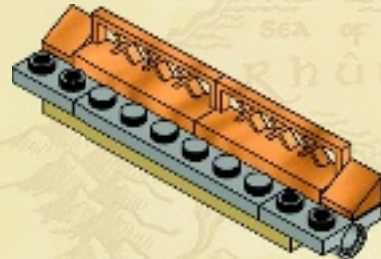

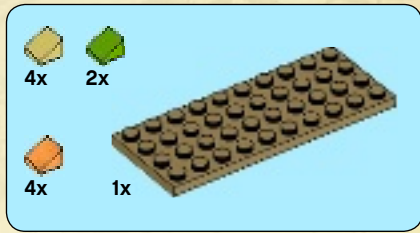

5

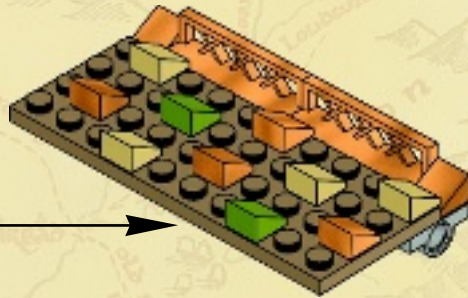
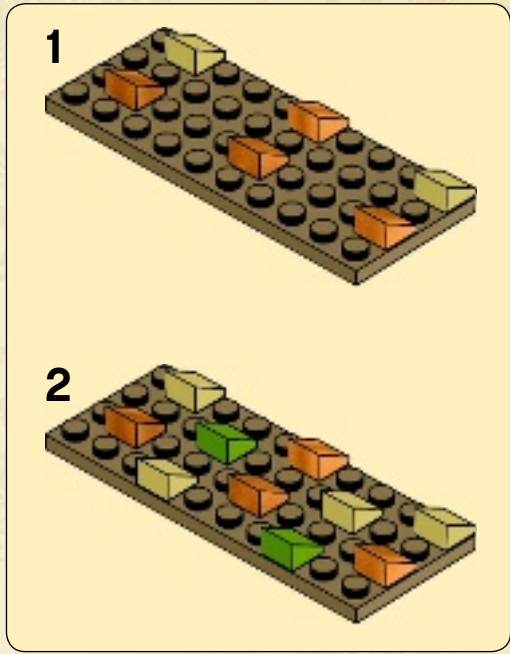



2x

6

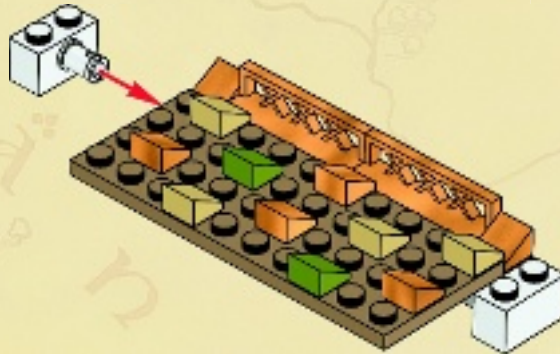

28





2x



2x



2x

29

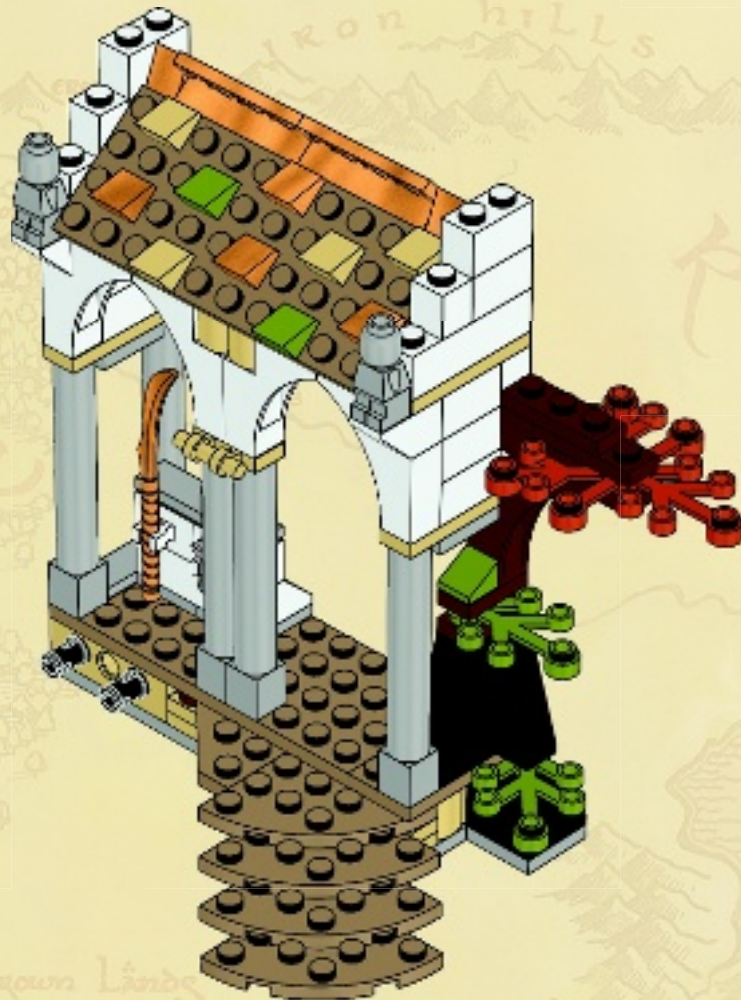



2x

30



31







2x
4278422

2x
4185273

2x
4598467

7x
4113233

2x
4114309

2x
4234365

2x
4157277

3x
4618876

3x
4114324

1x
4159774

1x
4113988

2x
362323

1x
366021

1x
302121

2x
301021

1x
4613174

3x
4225201

1x
281726

3x
368026

2x
4121715

2x
265326

3x
6039193

2x
4141630

1x
6043758

1x
6043721

1x
6023554

1x
6040583

1x
6013711

1x
6009771

6x
4587002

2x
6013297

2x
4536675

1x
4273965

7x
4211152

1x
4610041

3x
4544525

7x
4216581

2x
4211149

9x
4211151

2x
4211150

1x
4211257

1x
4216695

1x
6002819

1x
6041726

1x
6003878

6x
4518557

6x
4518562

2x
6005225

1x
6038629

1x
6038646

1x
6002754

1x
6016987

1x
4211197

3x
6039192

4x
6044725

2x
4558465

3x
4540203

2x
4211398

3x
4211414

2x
4565393

2x
6045988

1x
4211356

1x
4560183

4x
4211452

8x
4211520

1x
4211360

2x
4662161

4x
6002841

5x
6006425

1x
6042873

1x
6042898

1x
6042908

1x
6005367

1x
6002763

5x
4179576

1x
6038637

1x
4267874

4x
4570451

2x
6001001

2x
301001

1x
303701

1x
6044693

1x
6038370

1x
4262974

4x
300501

9x
300401

2x
4117061

2x
4160228

2x
366501

1x
362201

4x
6038525

1x
4210997

1x
4262974

4x
4516055

1x
4565387

2x
4140593

4x
4121972

4x
4159196

8x
4218749

1x
4114084

Customer Service
Kundenservice
Service Consommateurs
Servicio Al Consumidor
LEGO.com/service or dial





□ 10237
Gandalf™ the Grey



□ 79005
Saruman



□ 79006
Elrond



□ 79008
Mordor™ Orc

□ 10237
Great Eagle



□ 79008
King of the Dead



□ 10237
Grima Wormtongue



□ 79006
Frodo Baggins™



□ 10237
Uruk-hai™



□ 79008
Soldier of the Dead



□ 79008
Aragorn™



□ 79008
Mordor Orc



□ 79007
Gandalf™ the White



□ 79008
Legolas Greenleaf™



□ 10237
Saruman



□ 79007
Mouth of Sauron



□ 79007
Aragorn



□ 79006
Gimli™



□ 79008
Pirate of Umbar



□ 79008
Gimli



□ 79005
Gandalf the Grey



□ 79007
Great Eagle



□ 79007
Mordor Orc



□ 79008
Soldier of the Dead



□ 10237
Orc Pitmaster



□ 79007
Mordor Orc



□ 79006
Arwen



LEGO.com/thelordoftherings

79007

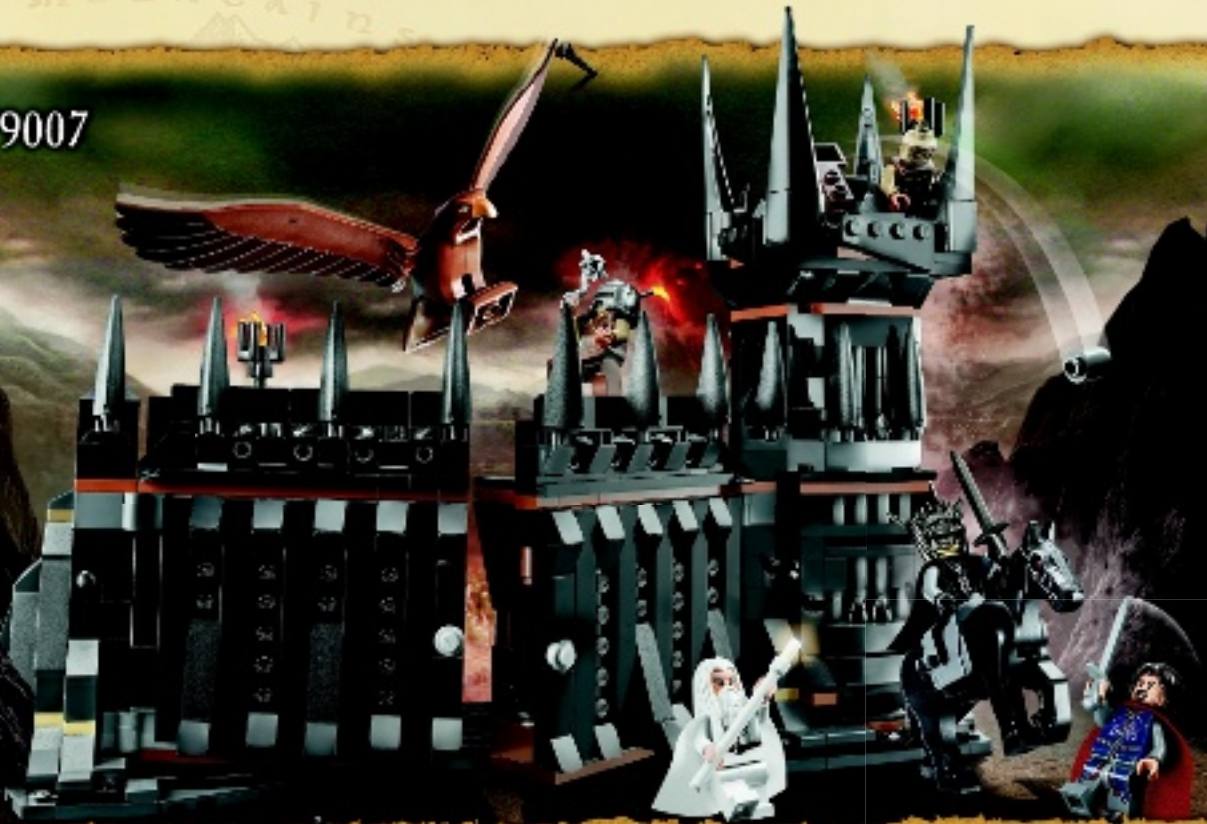

79007

79007



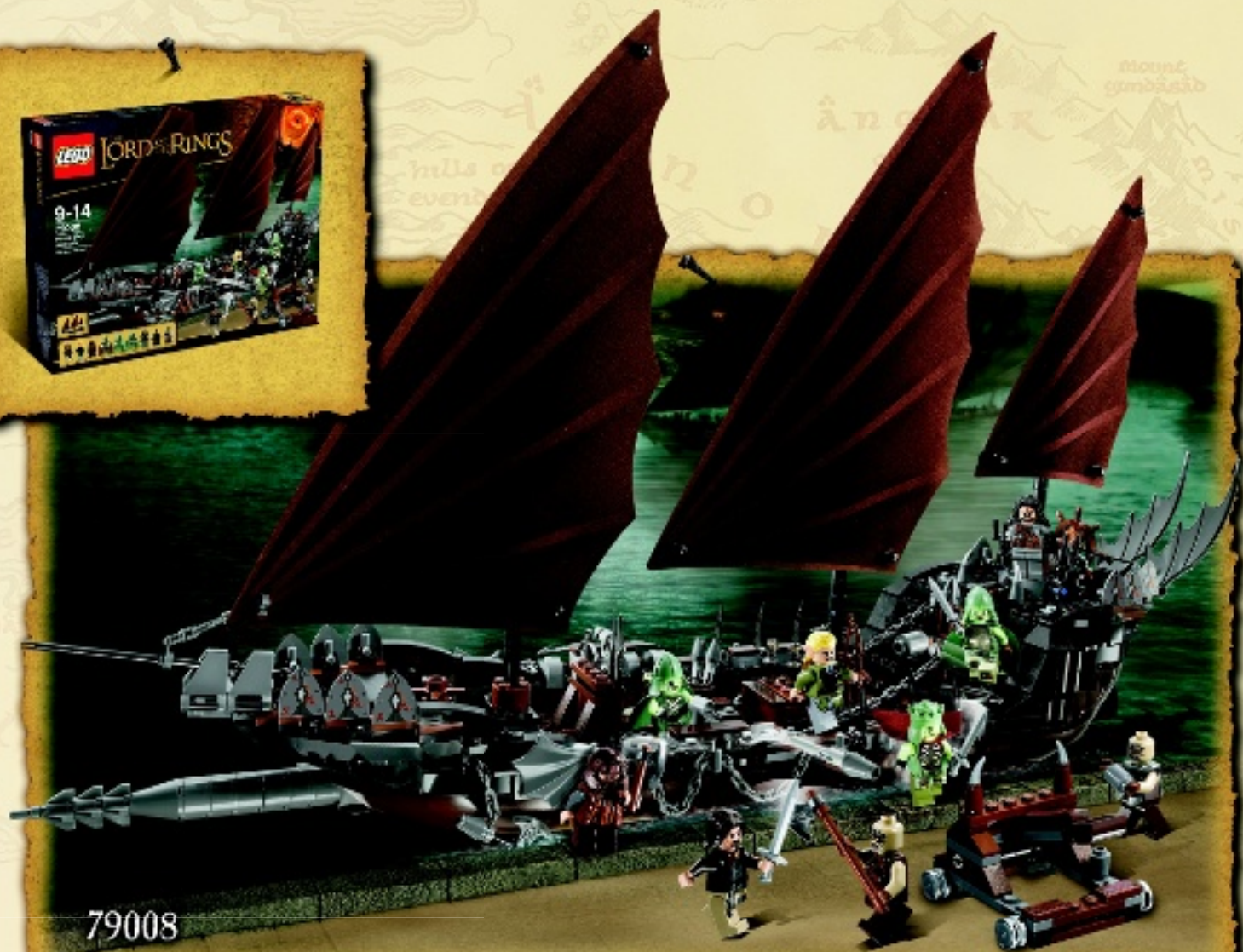

79008



THE LORD OF THE RINGS



LEGO and the LEGO logo are trademarks of the LEGO Group. ©2013 The LEGO Group. THE LORD OF THE RINGS: © NLP Middle-earth Ent. Lic. to New Line. (s13)

8+ 15-35





THE LORD OF THE RINGS



LEGO.com/thelordoftherings

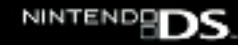
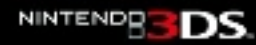
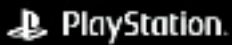

LEGO THE LORD OF THE RINGS software © 2012 TT Games Publishing Ltd. Produced by TT Games under license from the LEGO Group. LEGO, the LEGO logo, the Brick and the Knob configurations and the Minifigure are trademarks of the LEGO Group. © 2012 The LEGO Group. © 2012 New Line Productions, Inc. All The Lord of the Rings content other than content from the New Line films © 2012 The Saul Zaentz Company d/b/a Middle-earth Enterprises ("SZC"). Mithril, Morgul, The Lord of the Rings and the names of the characters, items, events and places therein are trademarks of SZC under license to Warner Bros. Interactive Entertainment. Nintendo trademarks and copyrights are properties of Nintendo. "PlayStation" and the "PS" Family logo are registered trademarks and the PlayStation Network logo is a trademark of Sony Computer Entertainment Inc. KINECT, Xbox, Xbox 360, Xbox LIVE, and the Xbox logos are trademarks of the Microsoft group of companies and are used under license from Microsoft. All other trademarks and copyrights are the property of their respective owners. All rights reserved.

WB GAMES LOGO, WB SHIELD: TM & © Warner Bros. Entertainment Inc. (s12)





club™

Free*! Gratuit!

* Paid subscription in Australia and New Zealand.
Abonnement payant en Australie et Nouvelle-Zélande



LEGO.com/club



WIN!

Go to www.LEGOsurvey.com/product
to fill out a survey for a chance
to win a cool LEGO® Product.
No purchase necessary.
Open to all residents where not prohibited.



www.LEGOsurvey.com/product

GEWINNE! WIN!

Nimm an der Umfrage auf
www.LEGOsurvey.com/product
teil und hab die Chance ein cooles
LEGO® Produkt zu gewinnen!

Die Teilnahme am Gewinnspiel führt zu keinerlei
Kaufverpflichtungen. Teilnahme in allen nicht
ausgeschlossenen Ländern möglich.

Ga naar www.LEGOsurvey.com/product,
vul een enquêteformulier
in en maak kans op een
cool LEGO® product.

Geen aankoopverplichting.
Iedereen mag deelnemen, uitgezonderd
ingezetenden van landen waar een
enquêteverbod geldt.

GAGNE! 当てよう!

Visite www.LEGOsurvey.com/product
pour répondre à un
questionnaire et avoir une chance de
gagner un produit LEGO® très cool!

Aucune obligation d'achat.
Ouvert à tous les résidents des pays
autorisés.

www.LEGOsurvey.com/product にアクセスして、
アンケートにご記入ください。当選者にはレゴ®
製品を差し上げます。

お買い上げの必要はありません。

禁止されていない限り、すべての皆様にご利用いただけます。



LEGO.com

6053112

LEGO and the LEGO logo are trademarks of the LEGO Group. ©2013 The LEGO Group.
THE LORD OF THE RINGS: © NLP™ Middle-earth Ent. Lic. to New Line.
(s13)