

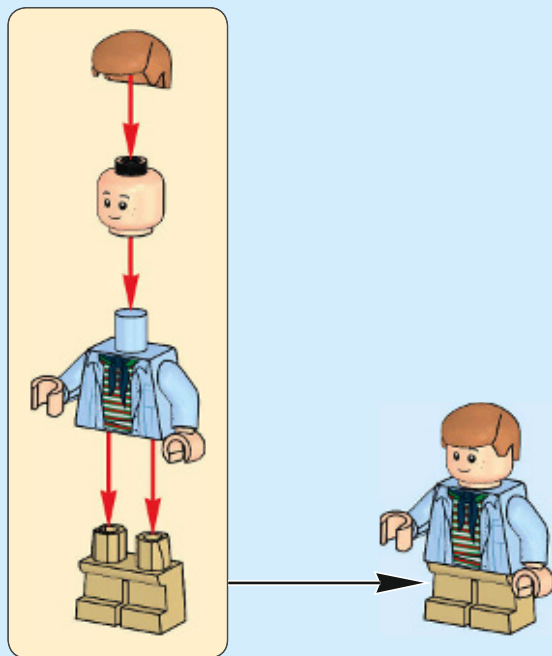

75932

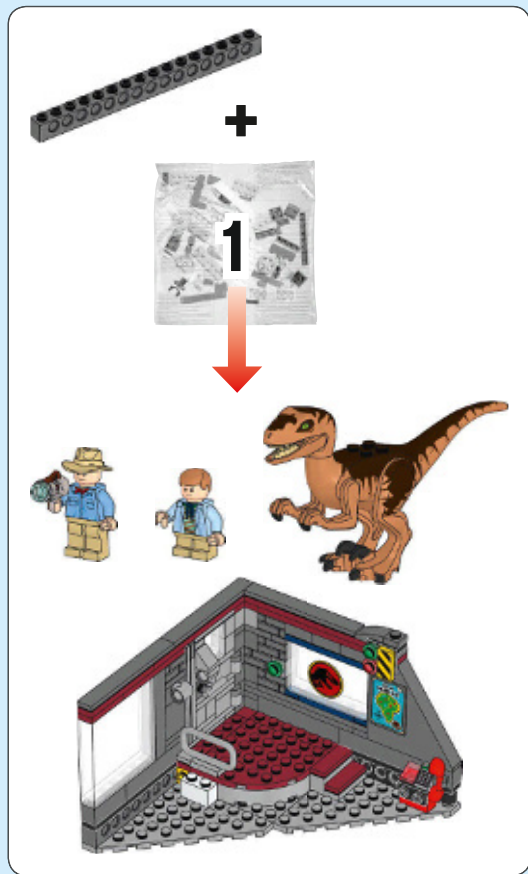





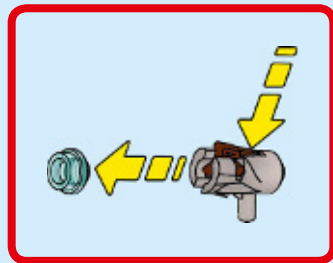
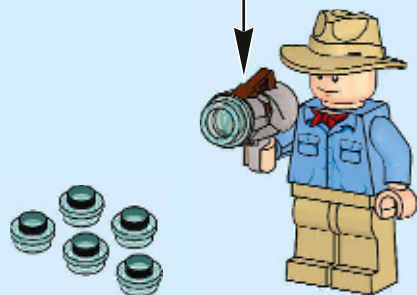
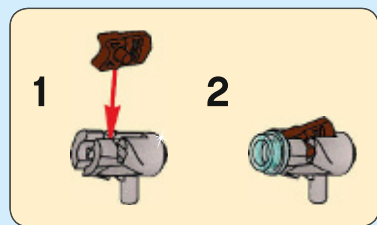
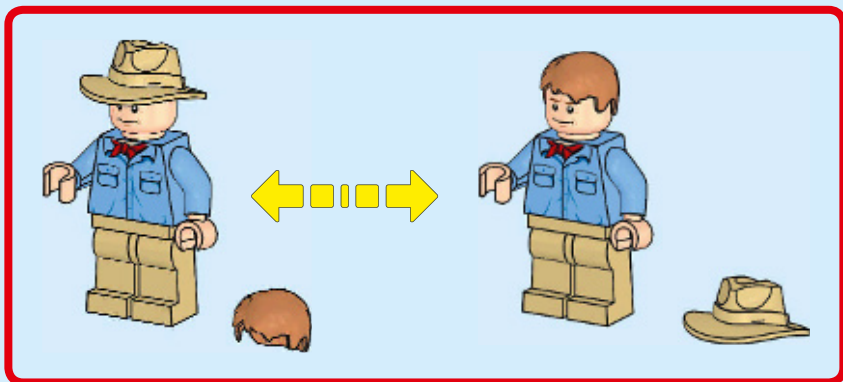

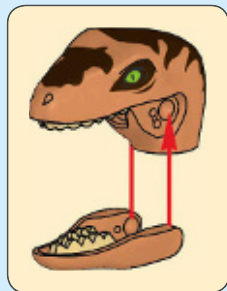
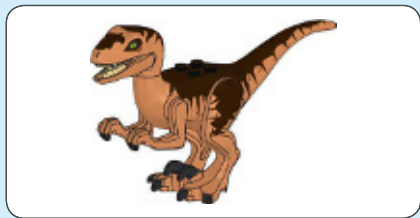

1

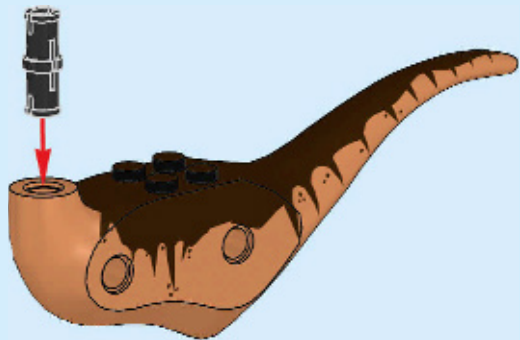

2

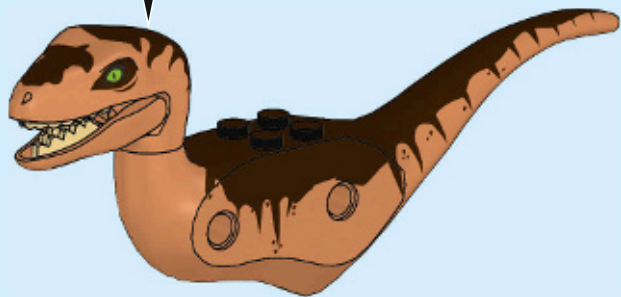

3



4



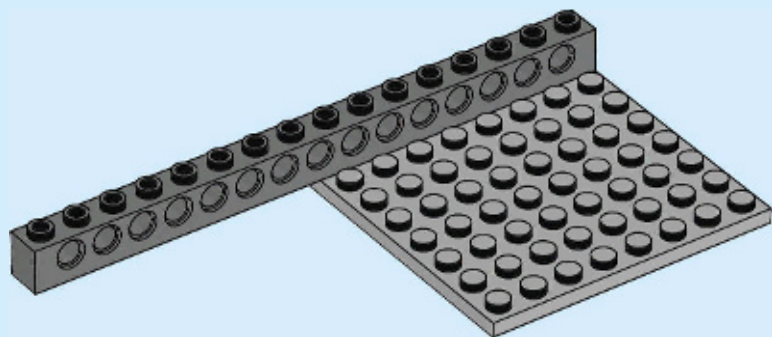
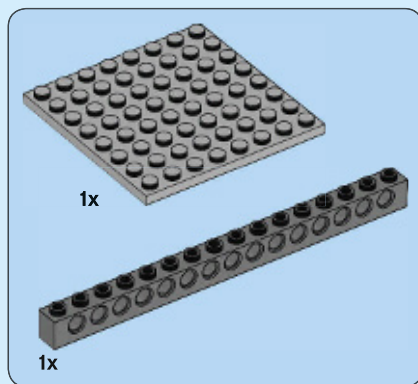

1

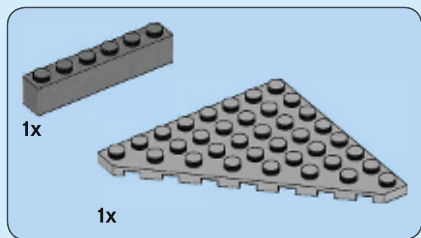

2

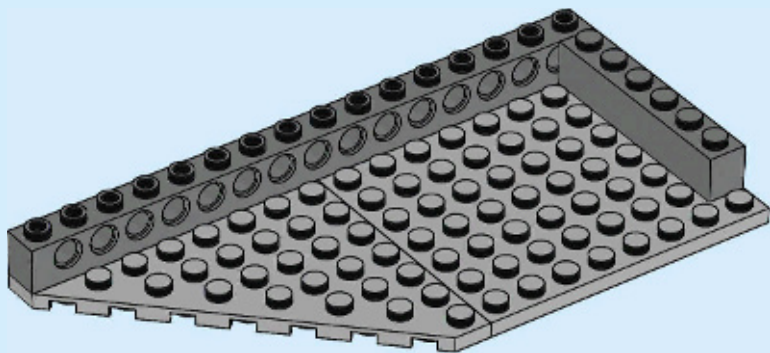

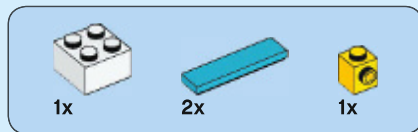

3

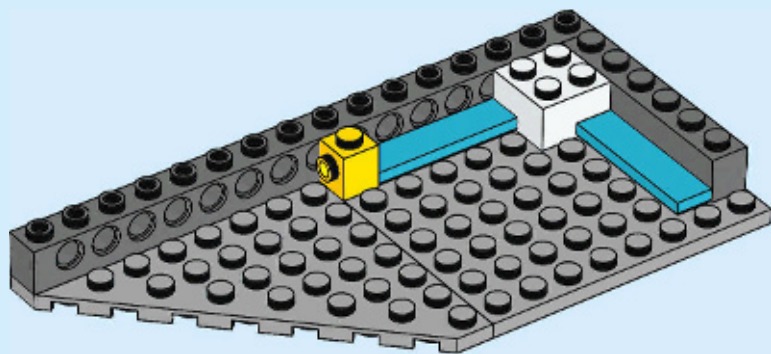

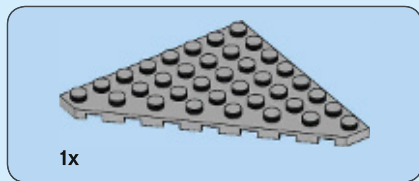

4

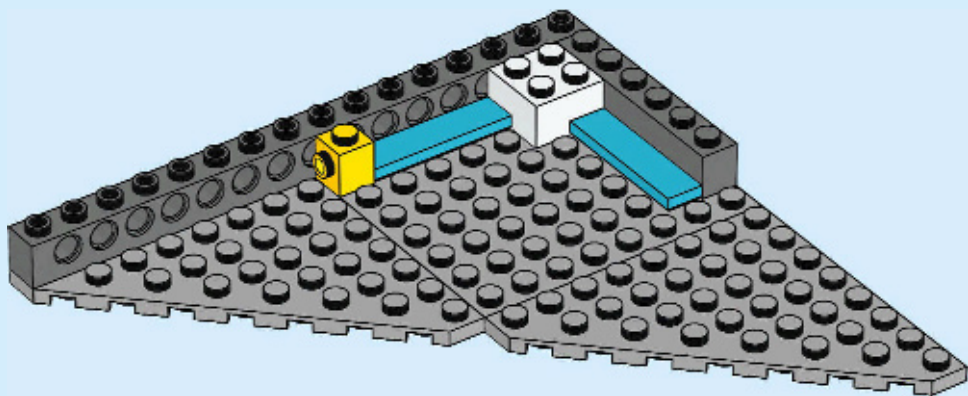



1x

5

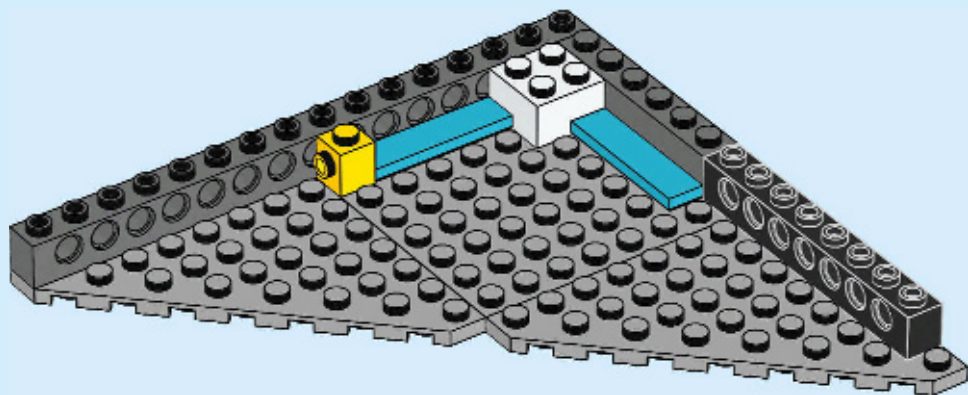

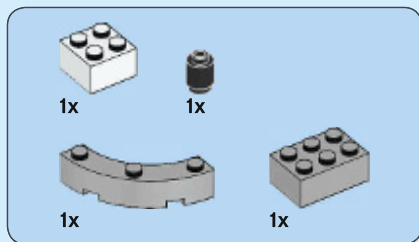

6

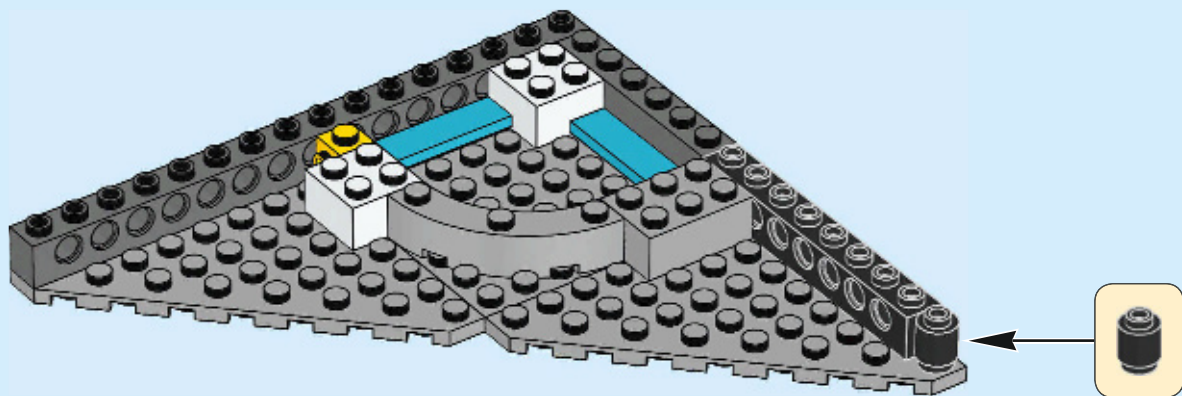



1x



1x

7

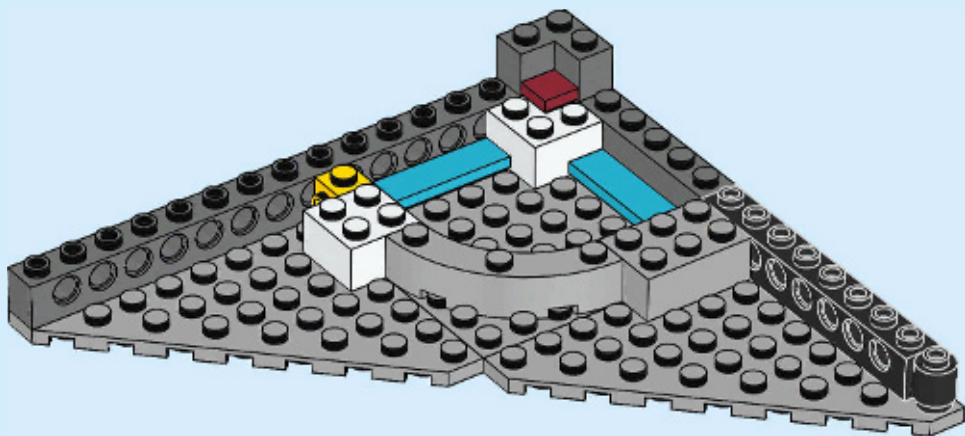

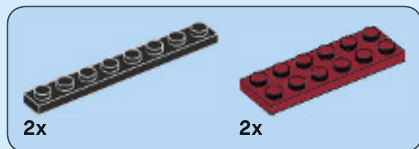

8

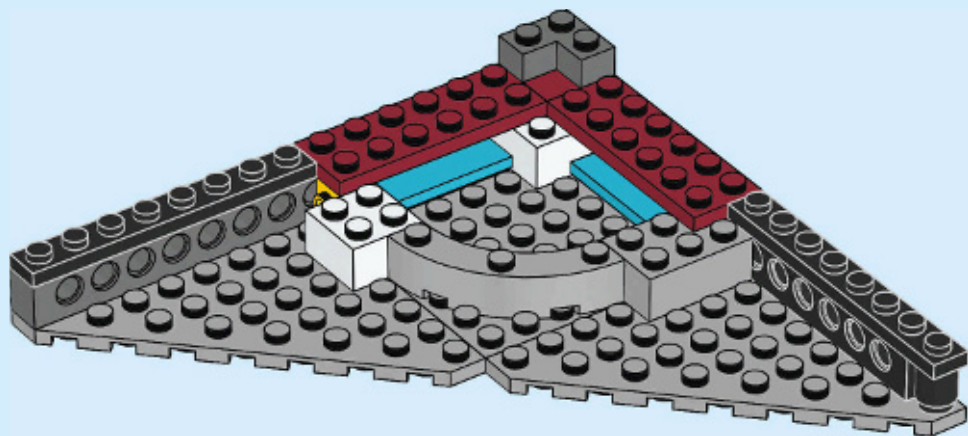

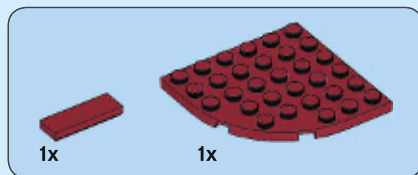

9

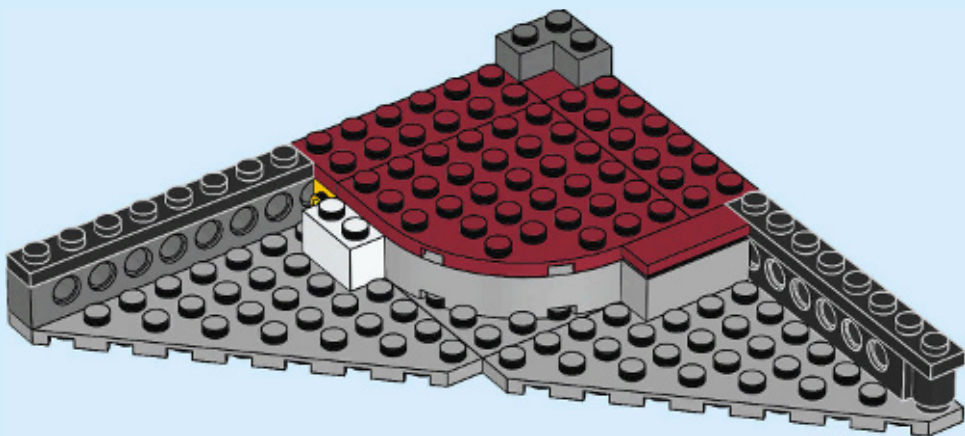

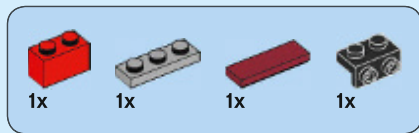

10

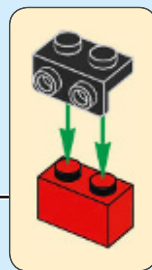
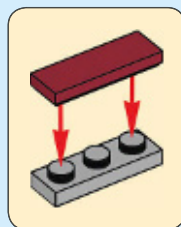
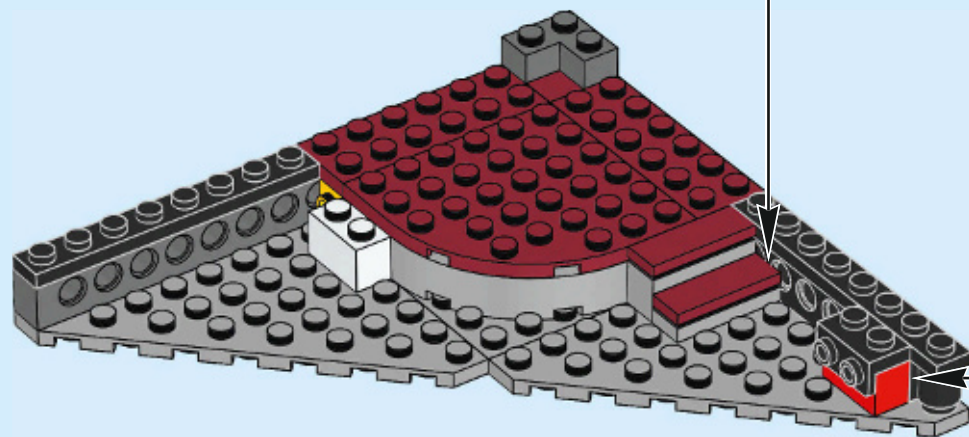

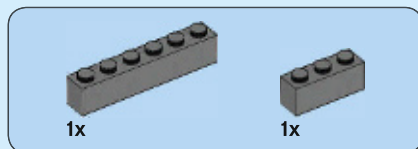

11

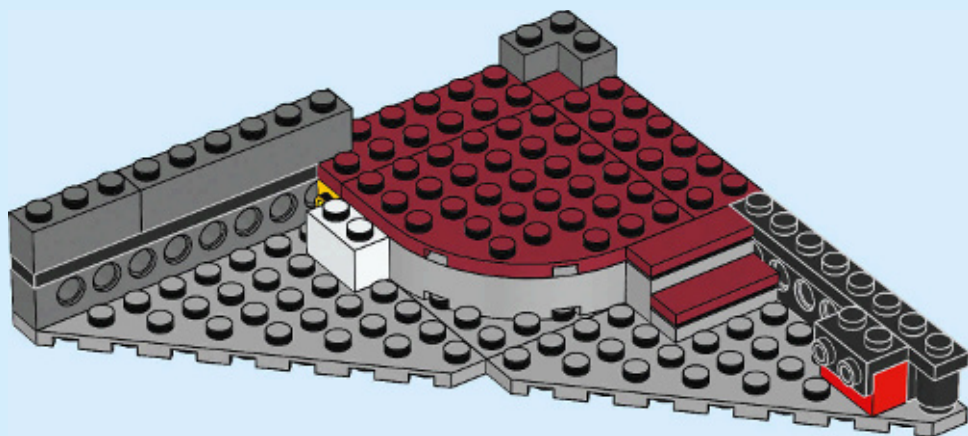



1x



2x

12

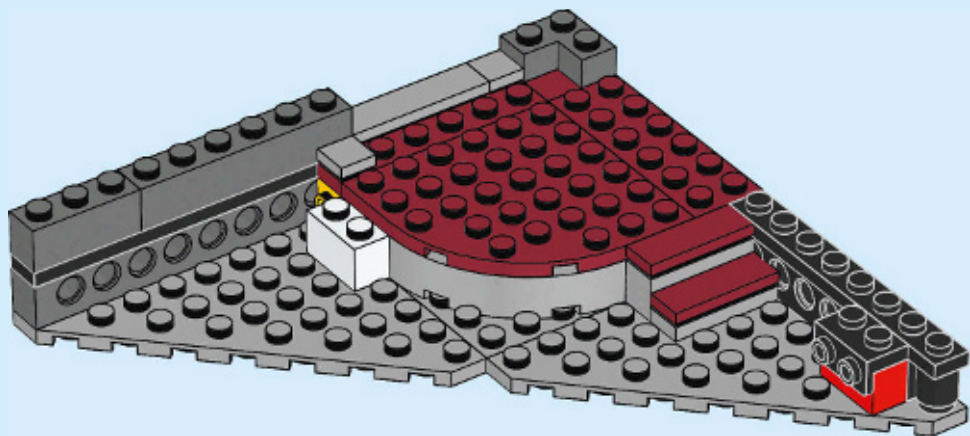



1x



1x

13

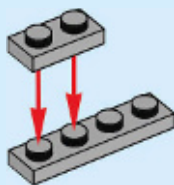

1x



1x

14

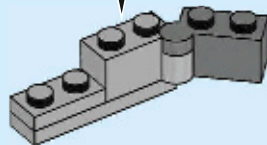
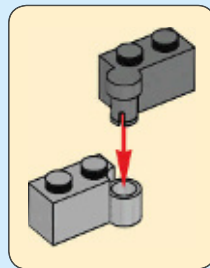



1x



1x



1x

15

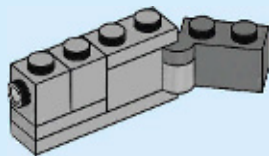

1x

16

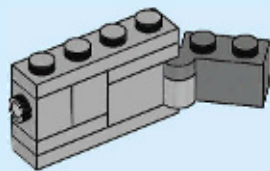

17

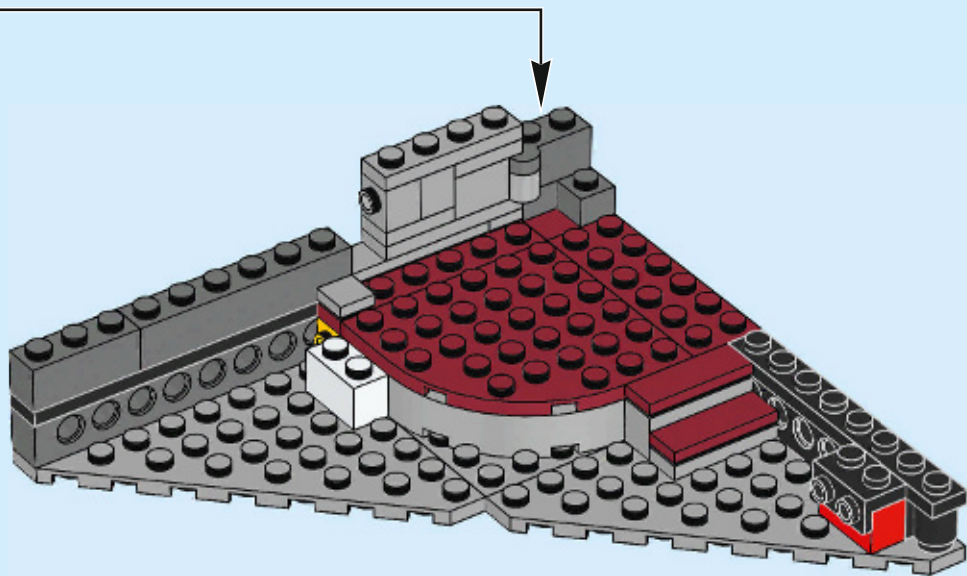

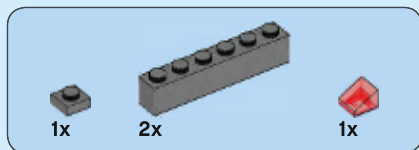

18

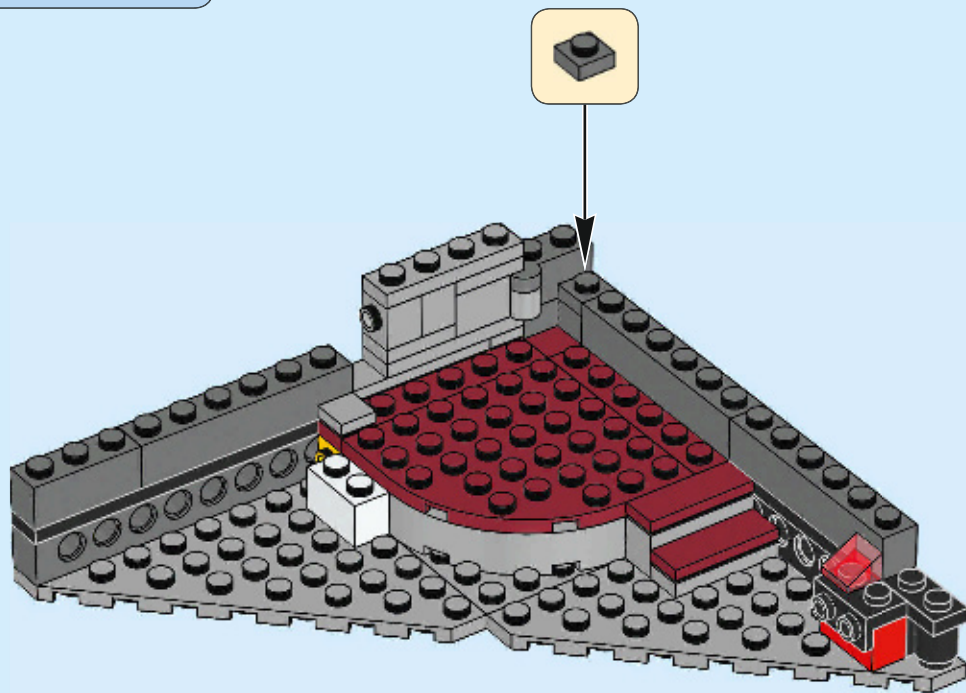



1x



1x

19

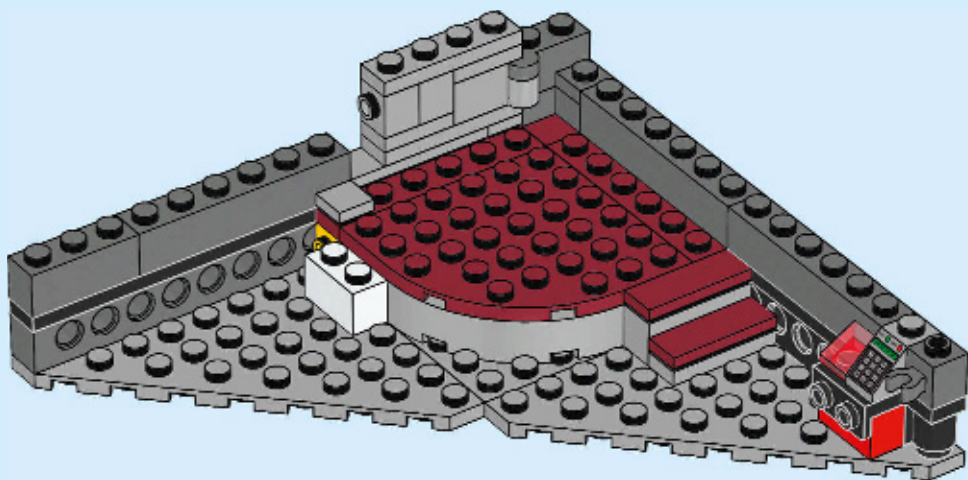

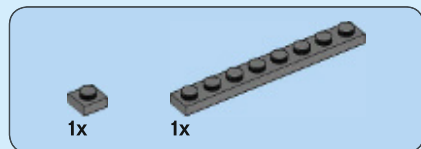

20

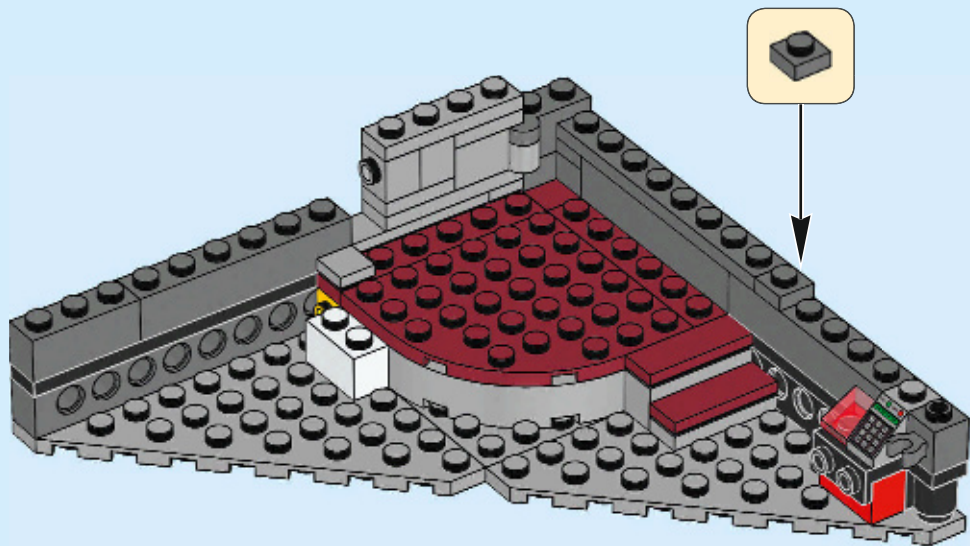

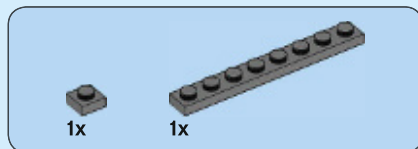

21

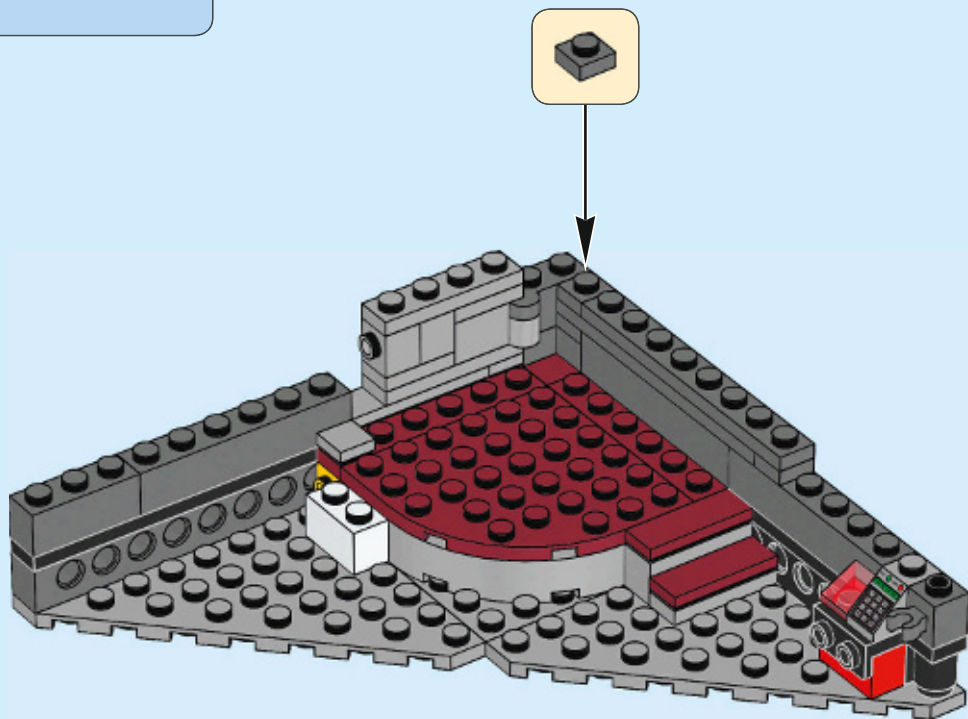

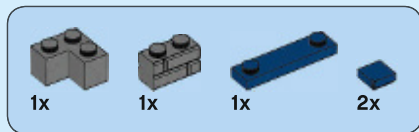

22

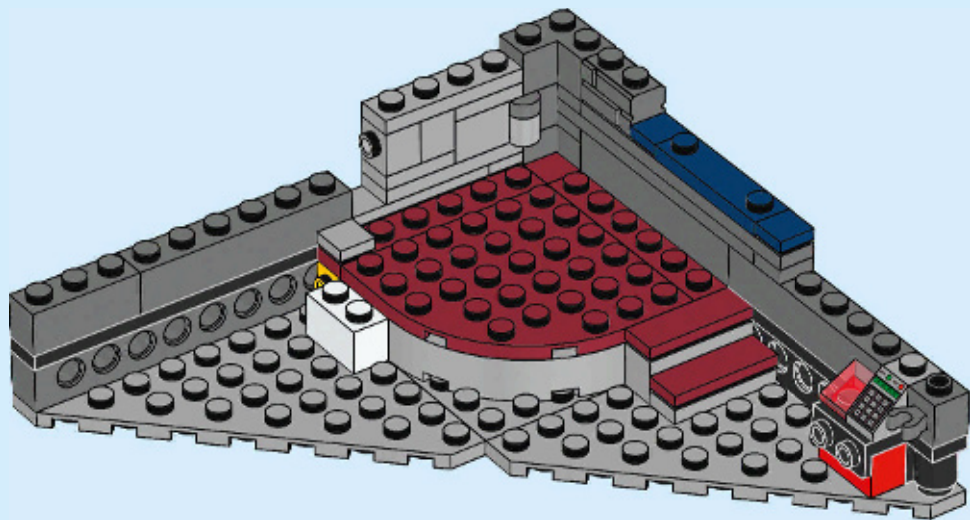



1x

23

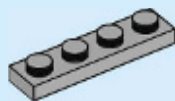

1x



1x

24

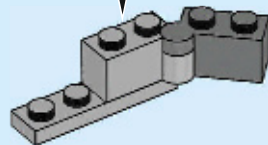
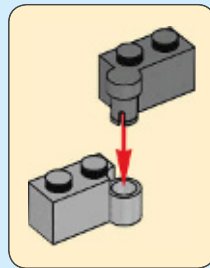



1x

25

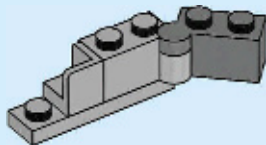

1x

26

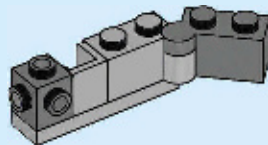



1x

27

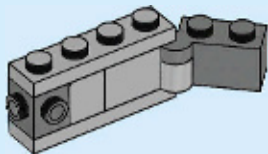

1x



2x



1x



1x

28

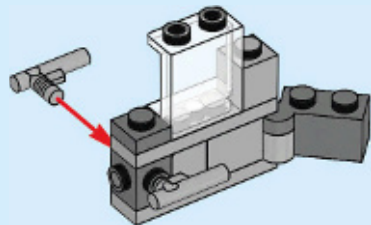



1x

29

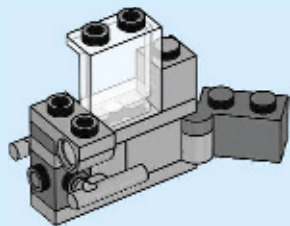

30



1x

30

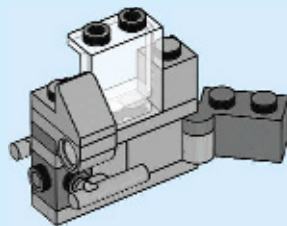



2x

31

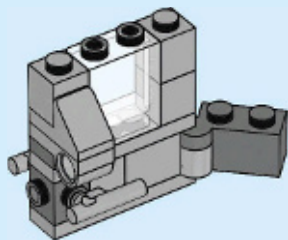

1x

32

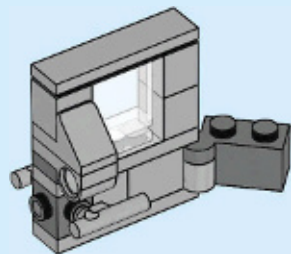

33

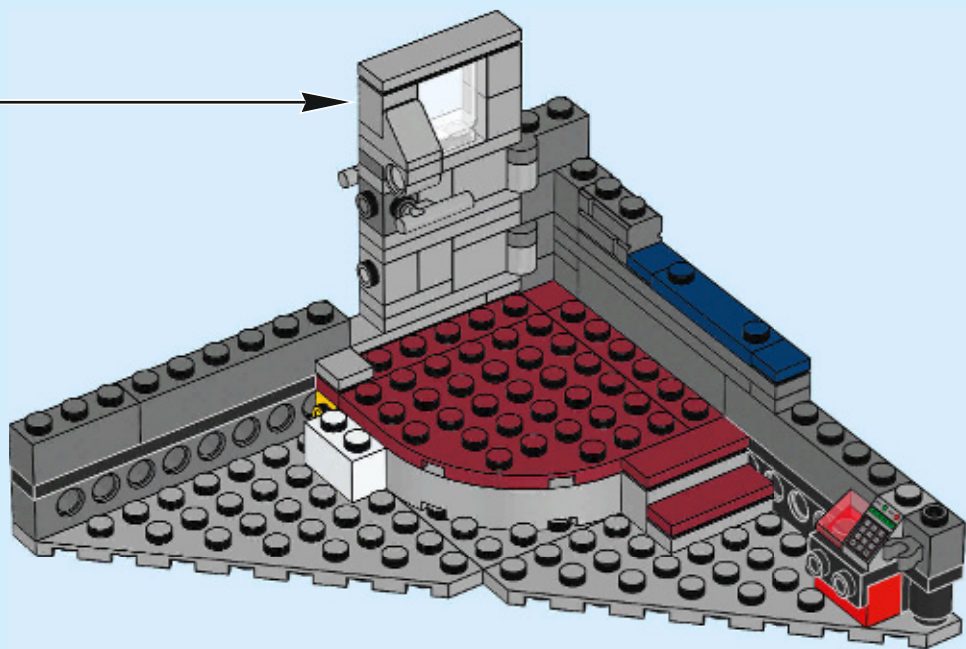

32

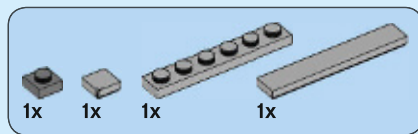

34

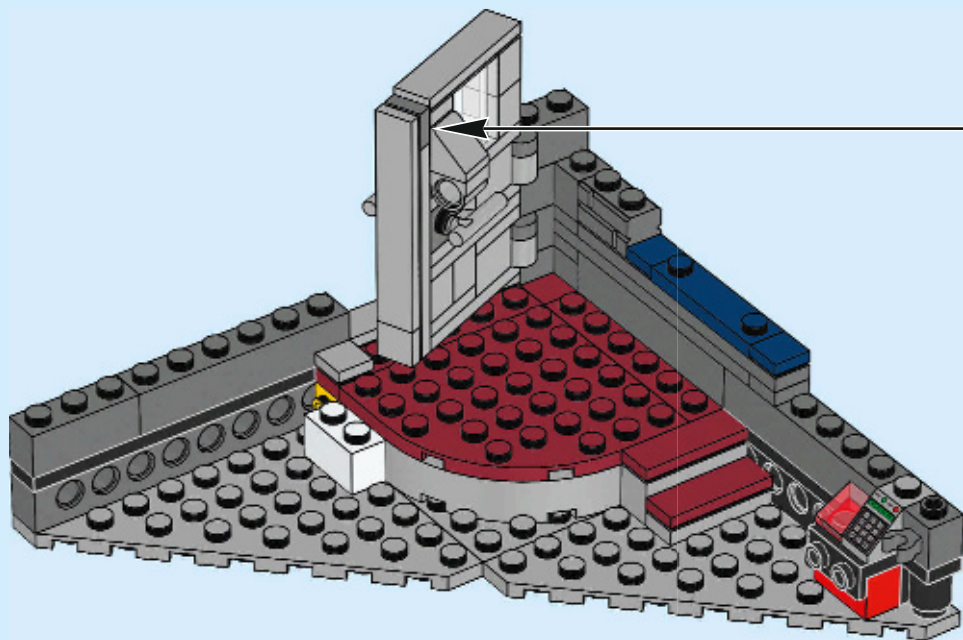
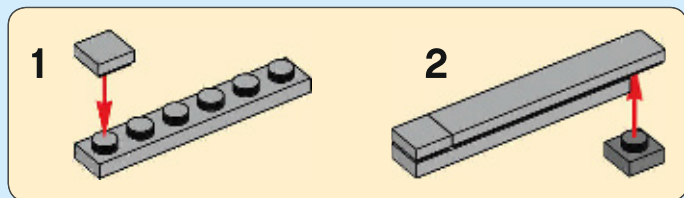



1x



1x

35

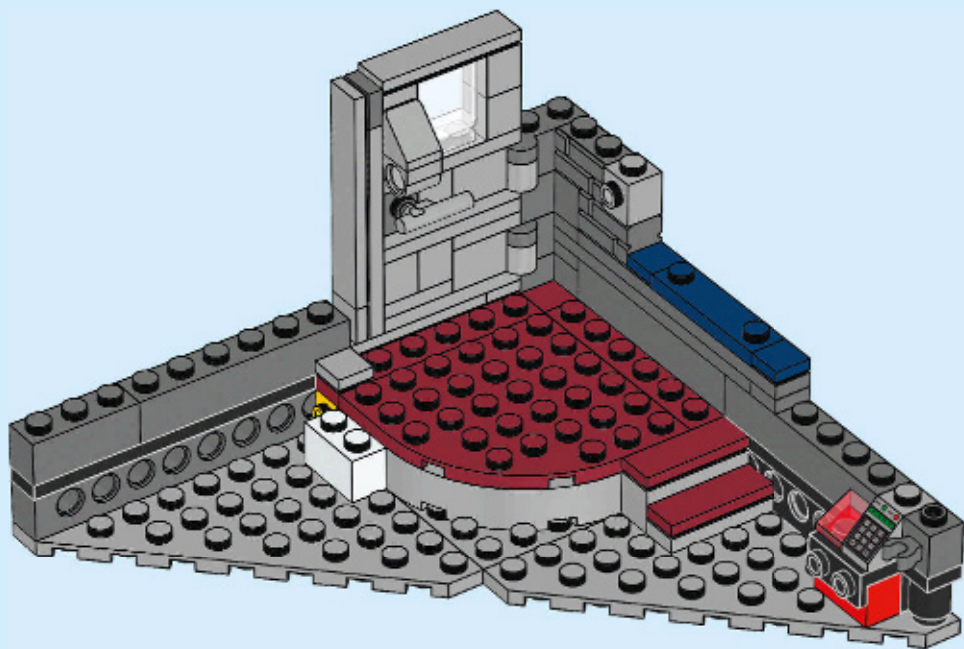



1x



1x



1x

36

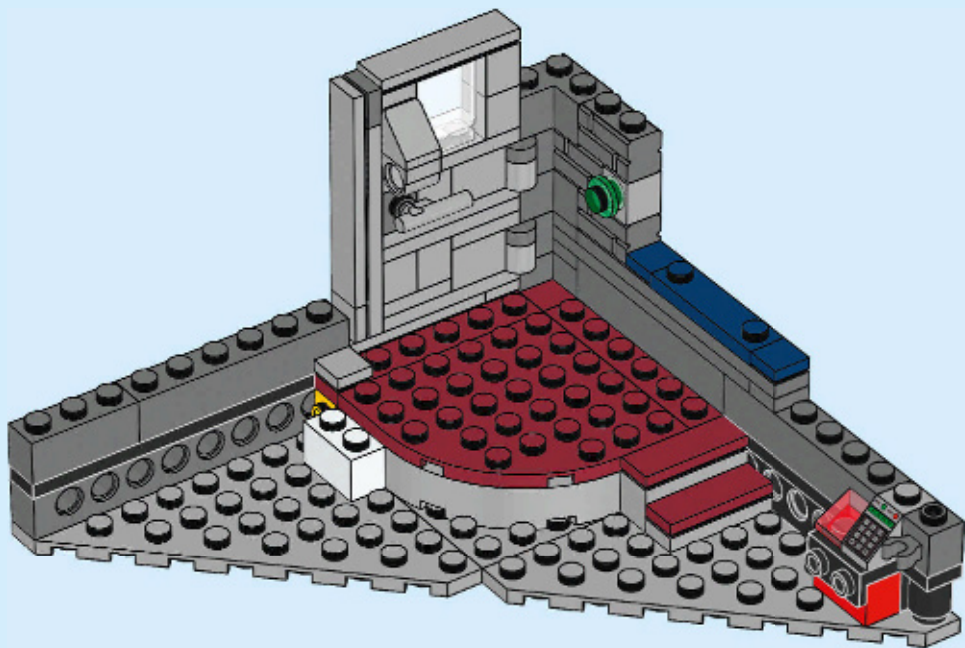



1x



2x

37

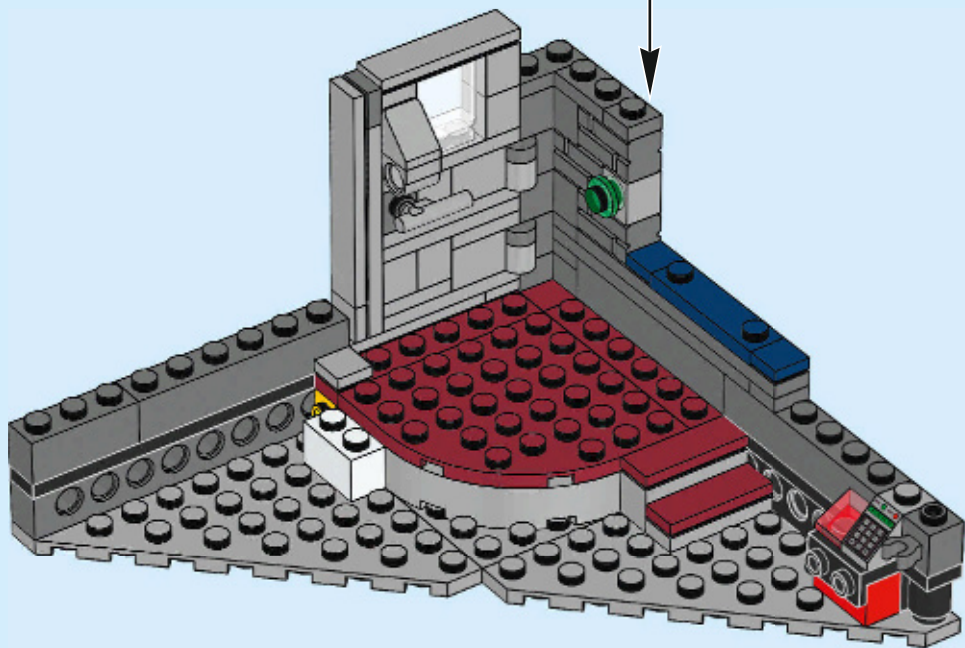



2x



1x



1x

38

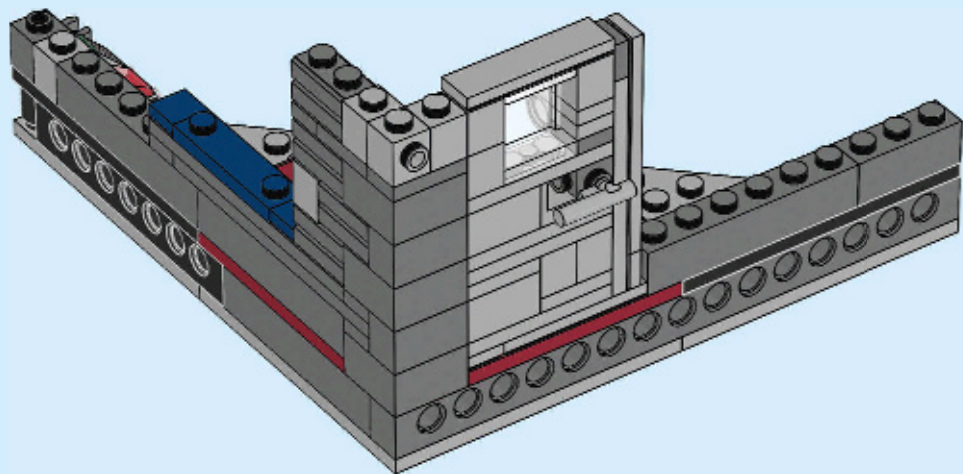
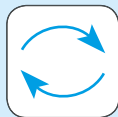

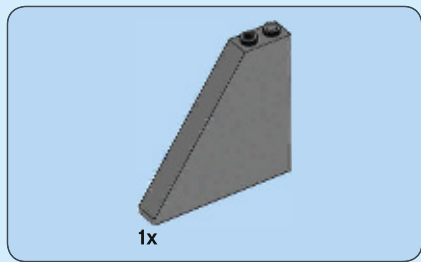

39

1

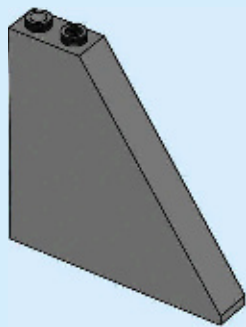

2

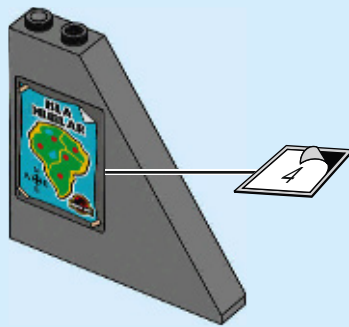

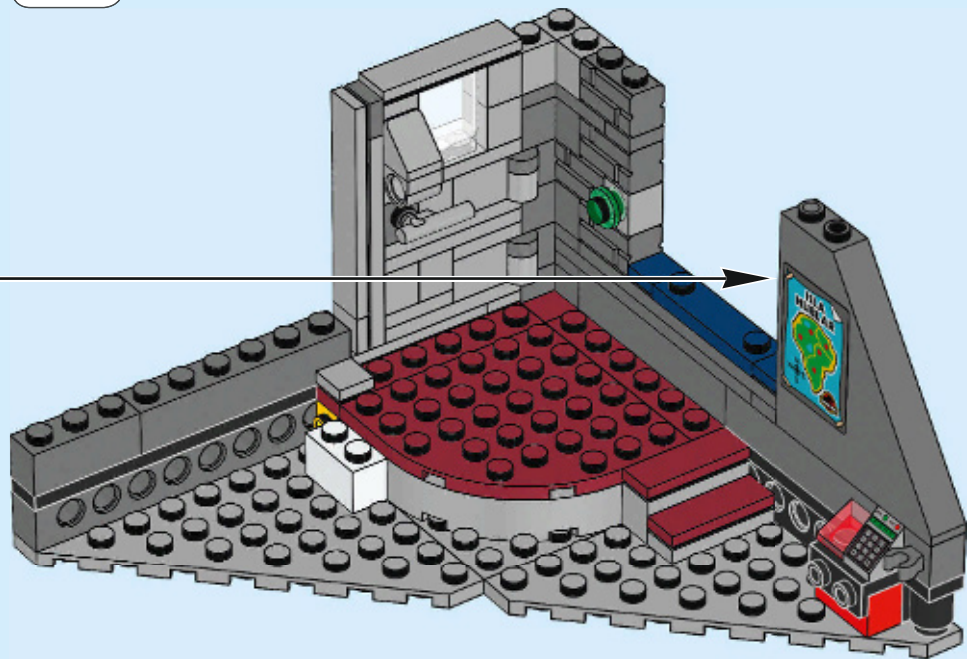
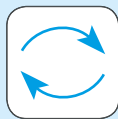

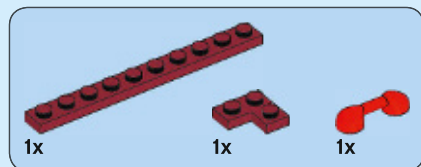

40

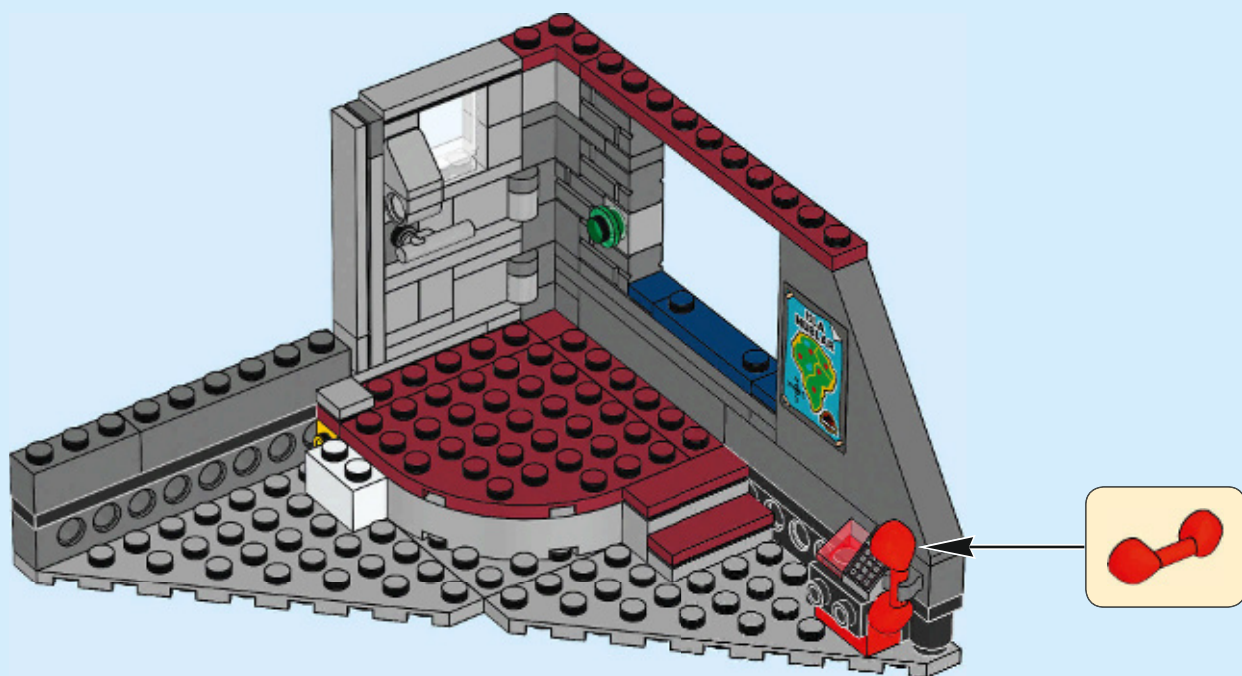

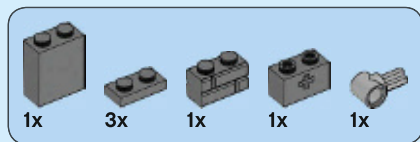

41

1

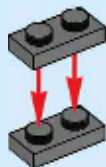

2

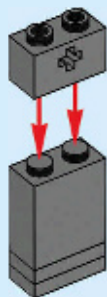

3

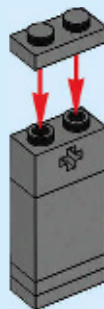

4

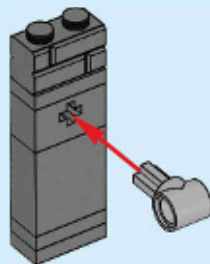

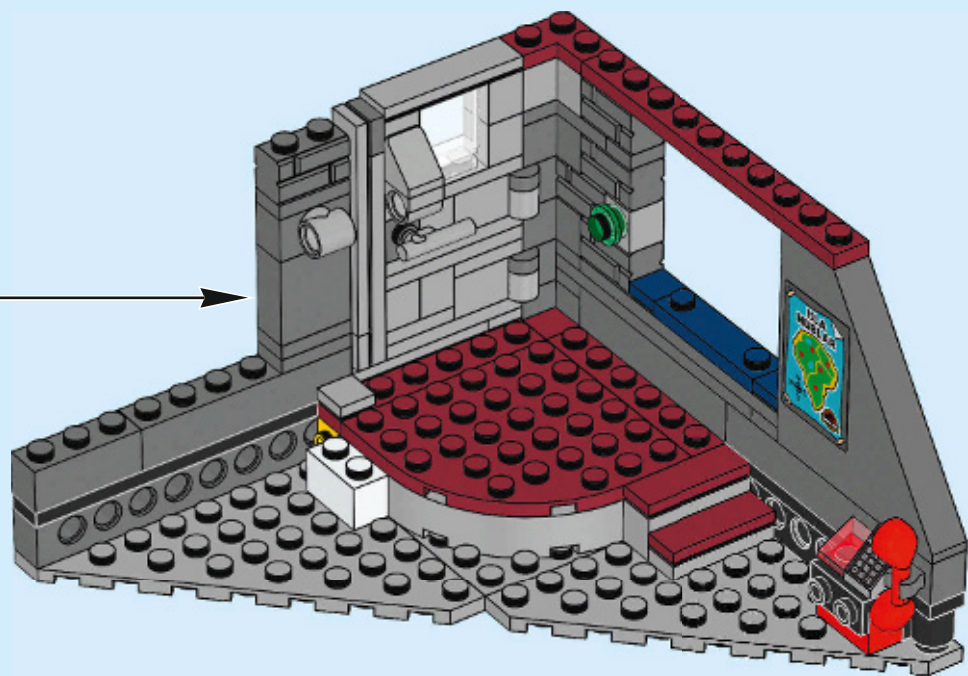

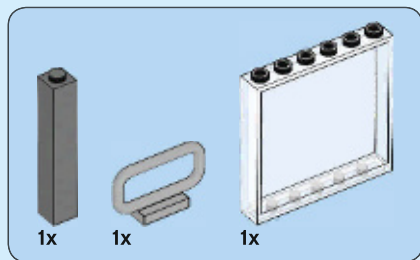

42

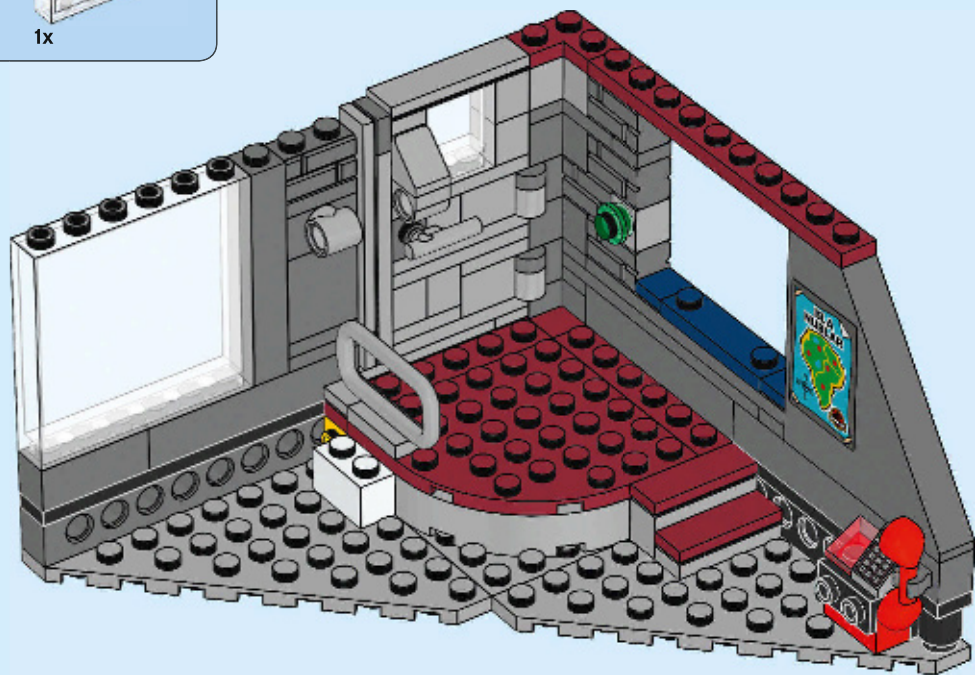

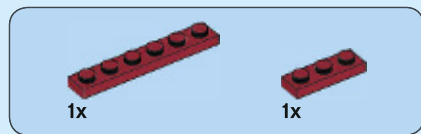

43

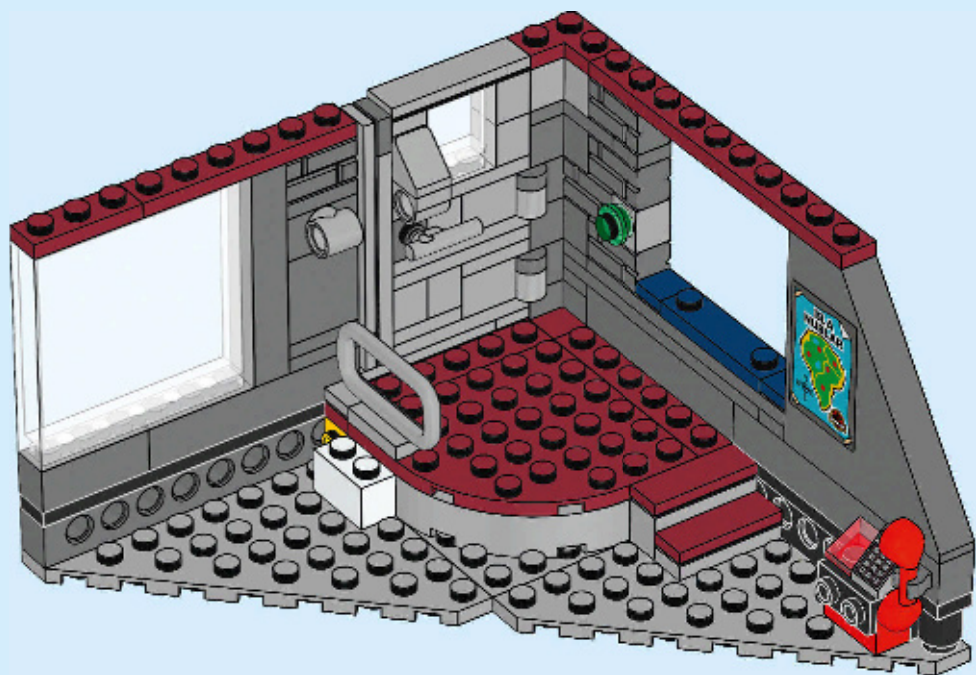

44

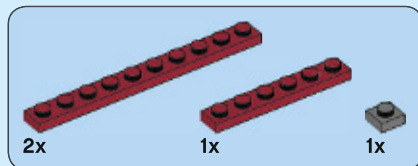

44

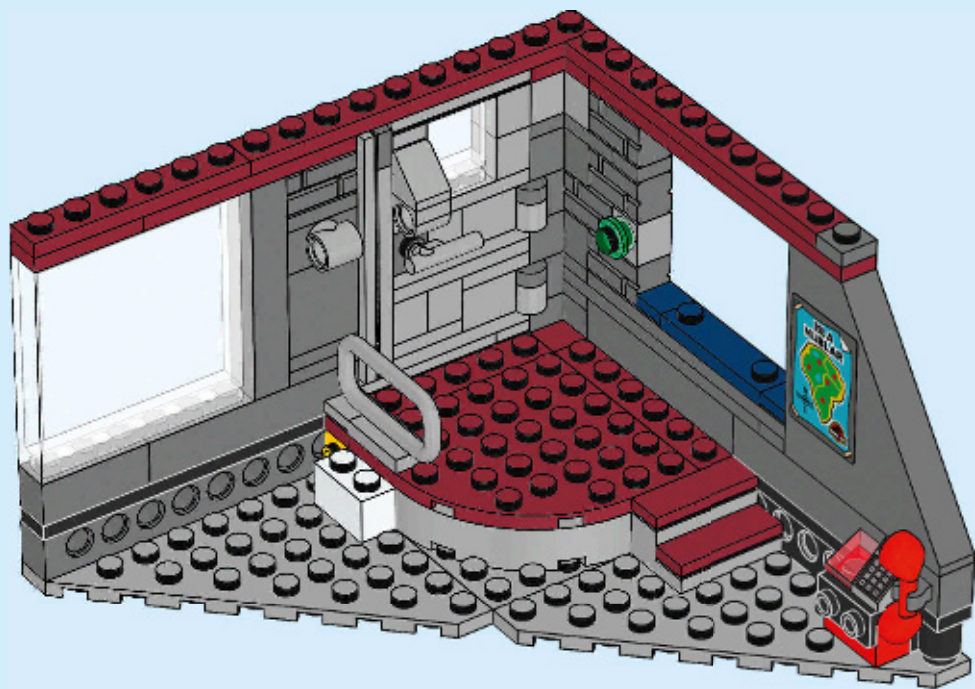

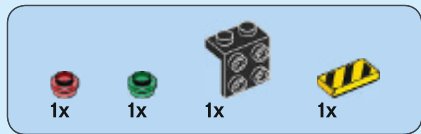

45

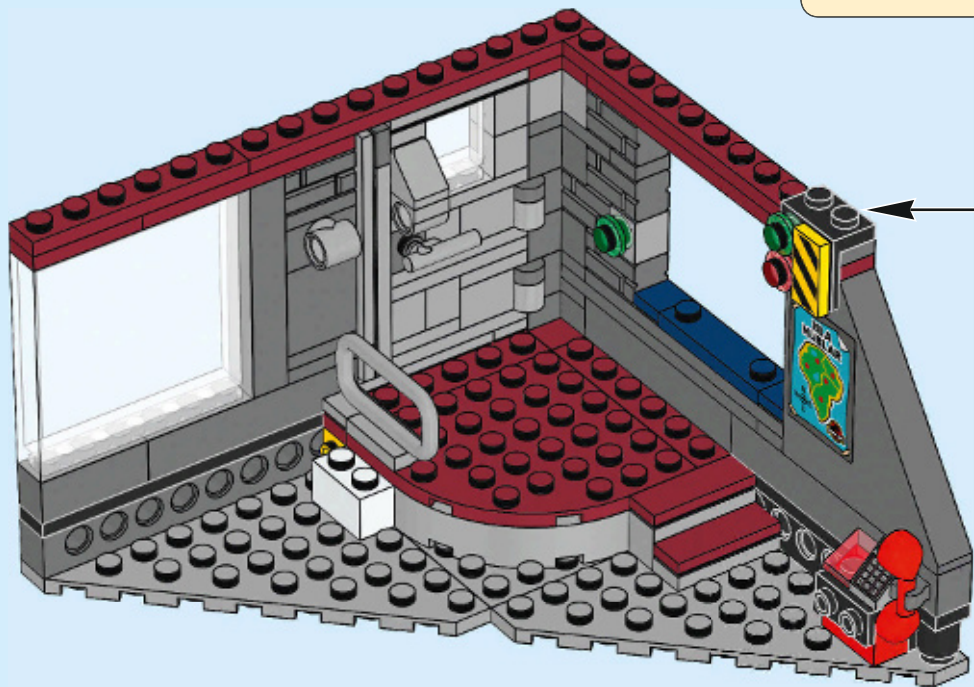

46



1x



1x

46

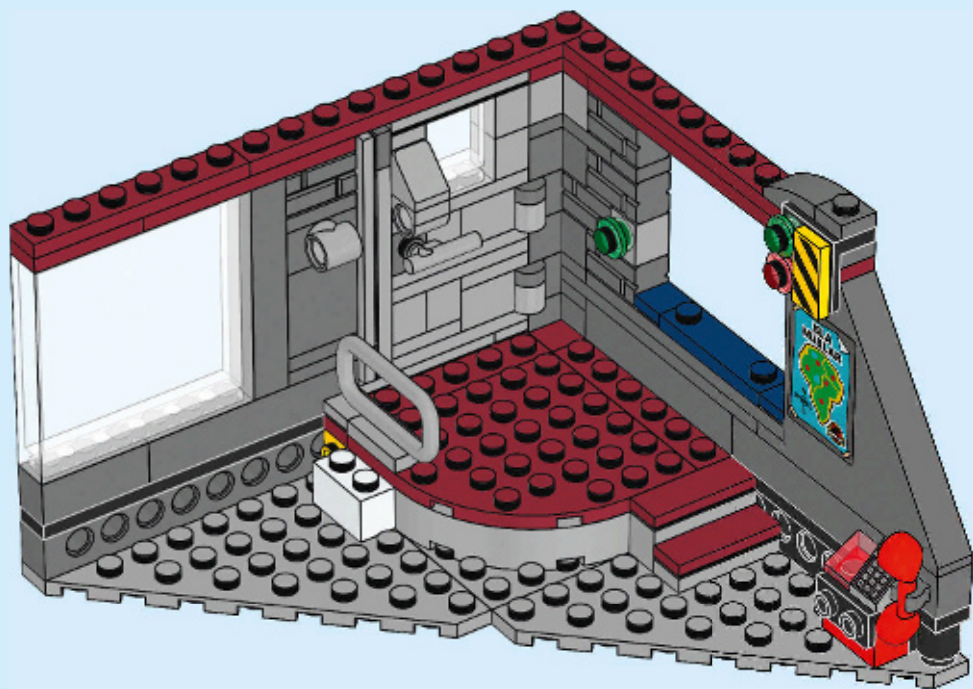

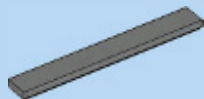

3x

47

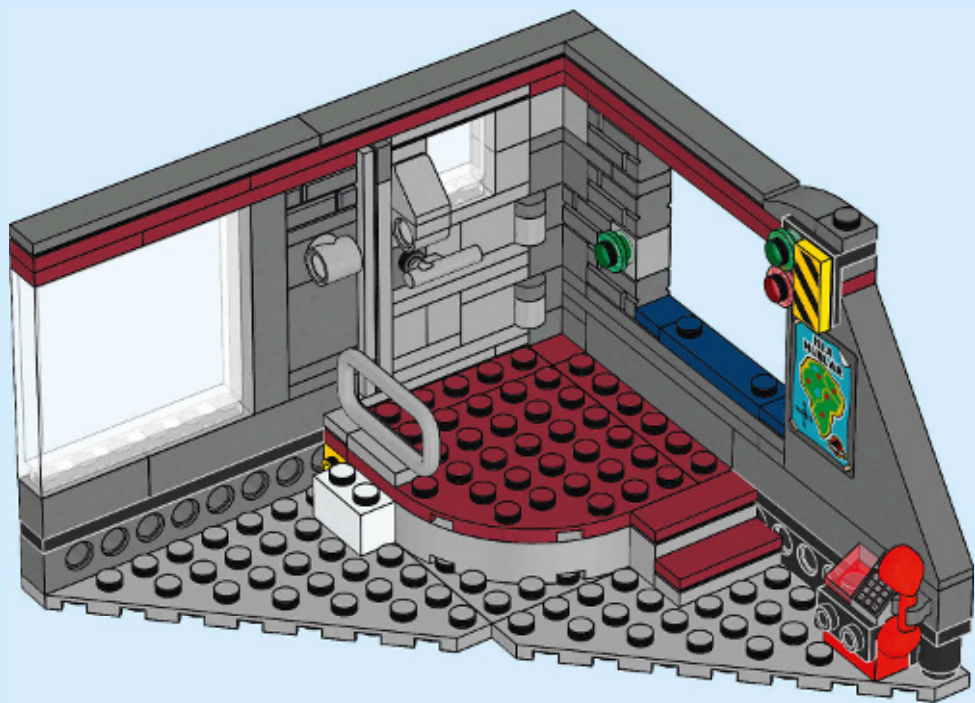

48

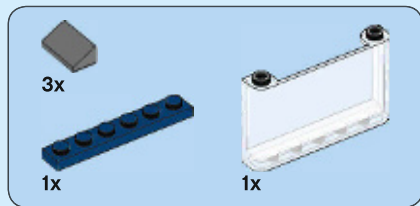

48

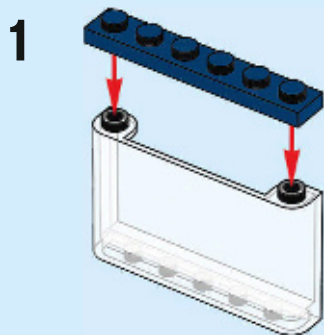

2

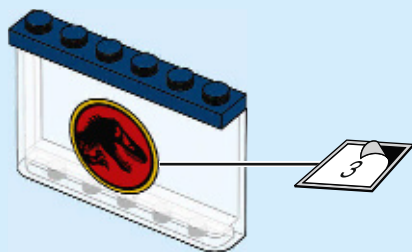

3



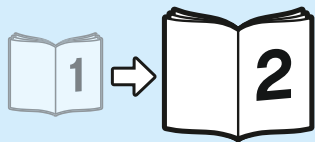
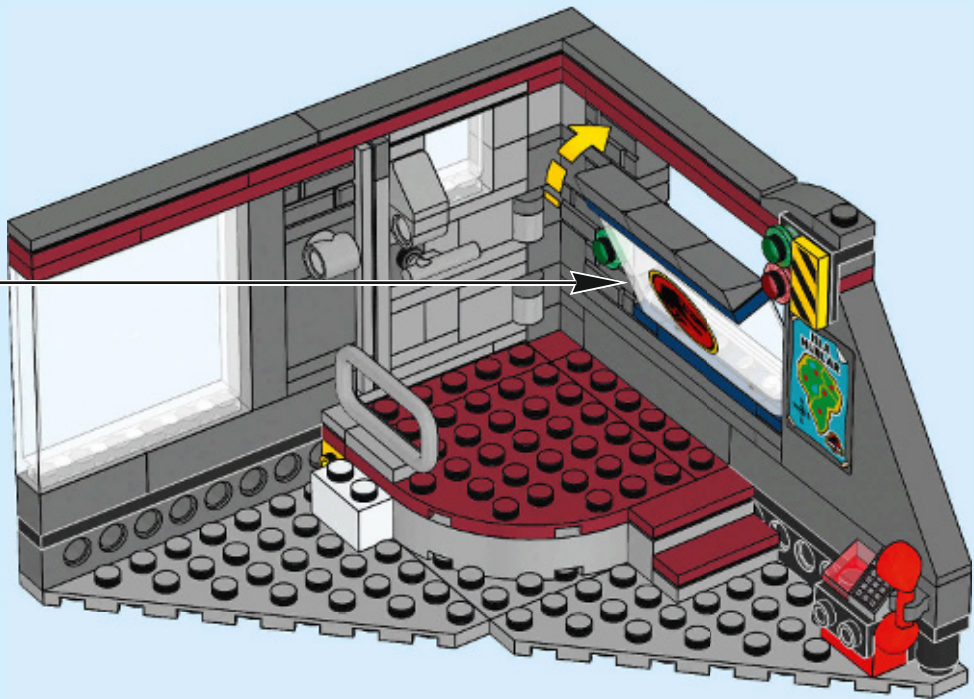

70637

The Knockout
Umstoßen
Le K.O.
Demolitore
El destructor
O Knockout
A kiütés
猛击

70635

The Leapfrog
Überspringen
Le Saut
Salto
La rana
O Salto ao Eixo
A bakugrás
蛙跳

70634

The Zen
Zen-Übung
Le Zen
Zen
El zen
O Zen
A zen
禅

70628

The Palm Spin
Handkreisel
Le « Palm Spin »
Rotazione sulla mano
En la mano
Spin na Palma da Mão
Kezi pörgettyü
掌中旋转

The Drift
Driften
Le dérapage
Sbandata
El derrape
Impulso Ondeante
Driftelés
疾速漂移

70636

70633

The Orbit
Umkreisen
L'Orbite
Orbita
La orbita
A Orbita
A pályá
发射轨道

SPINJITZU MASTERS



70628



70633



70634



70635



70636



70637

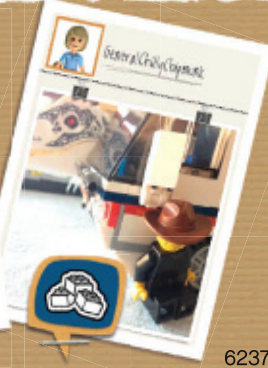
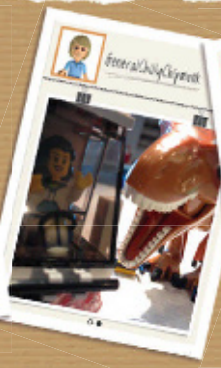
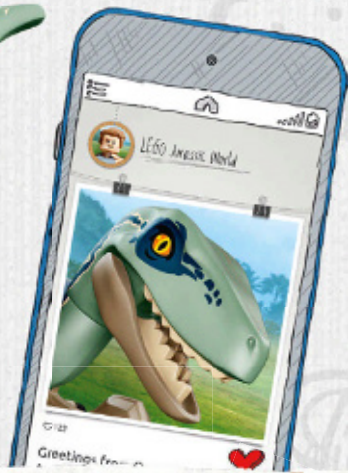

LEGO and the LEGO logo are trademarks of the LEGO Group. ©2018 The LEGO Group.
Jurassic World is a trademark and copyright of Universal Studios and Amblin Entertainment, Inc. Licensed by Universal Studios. All Rights Reserved.

6237327



75932



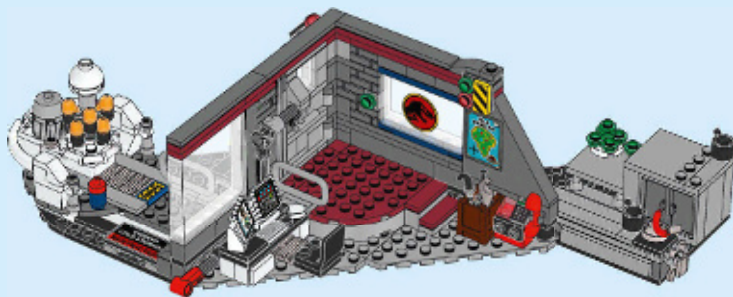
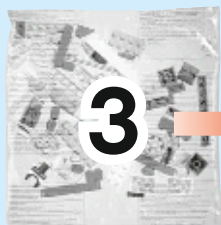
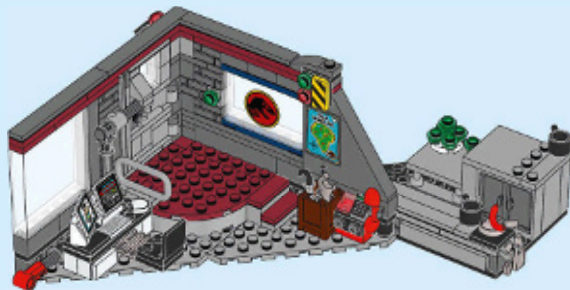
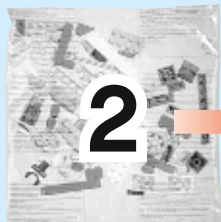

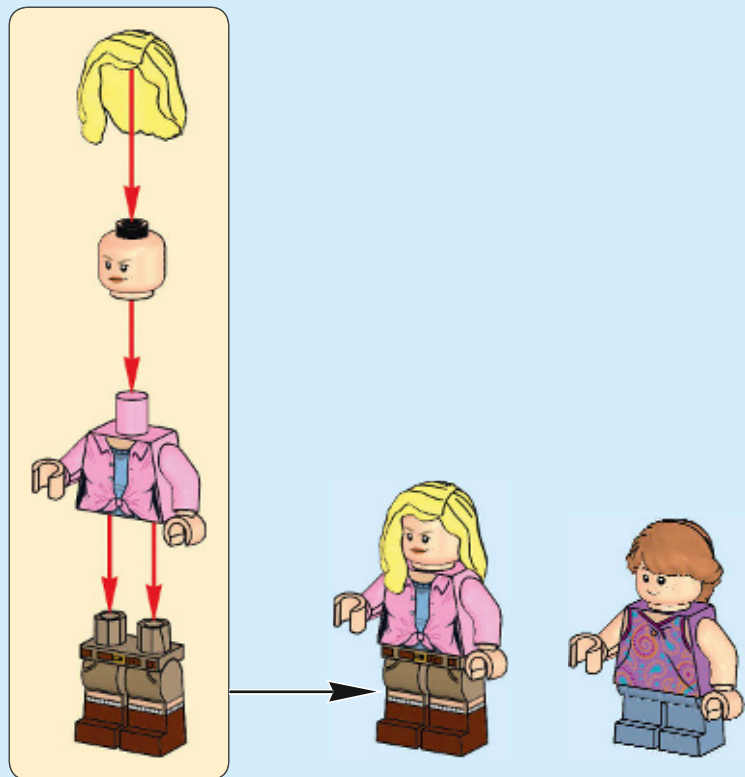
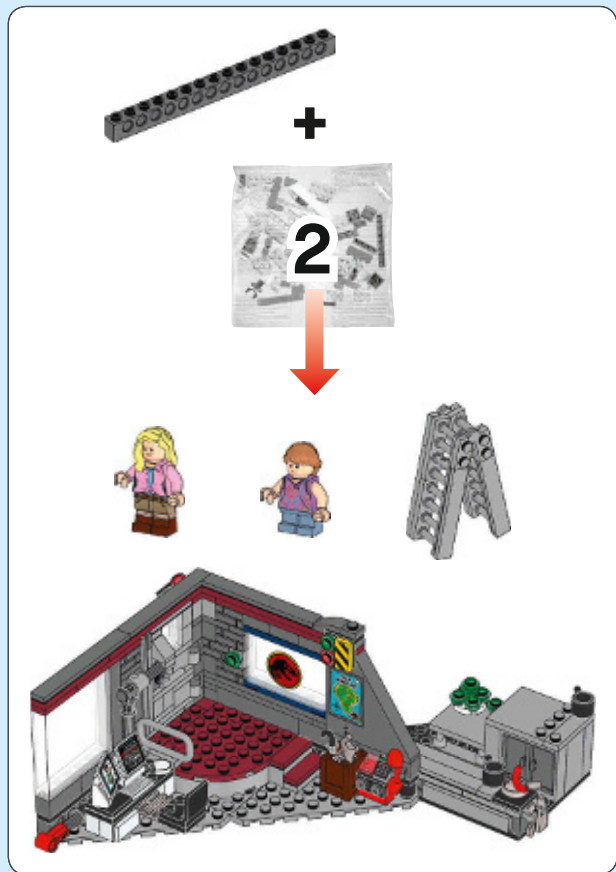



1x



2x

49

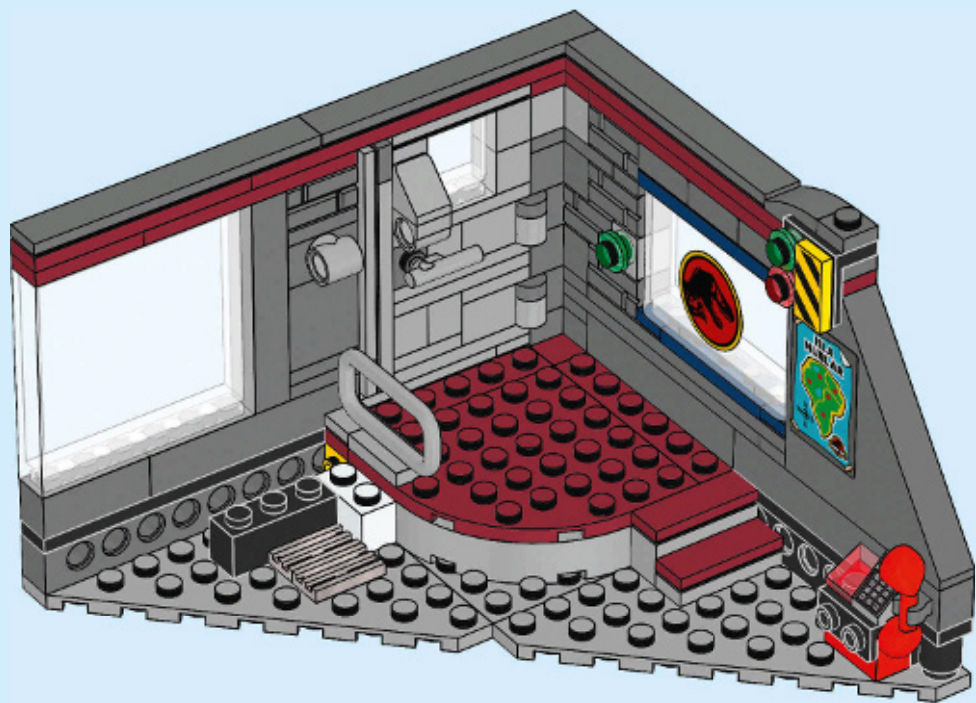

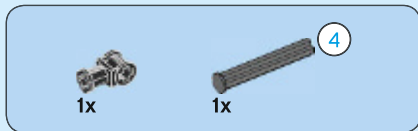

50

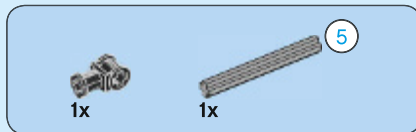
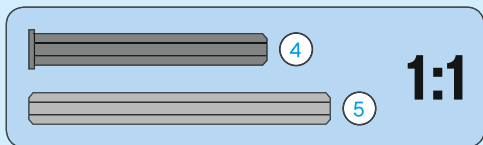
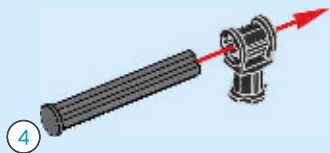

51

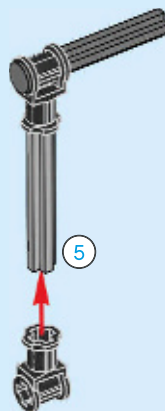

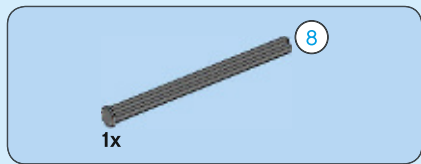

52

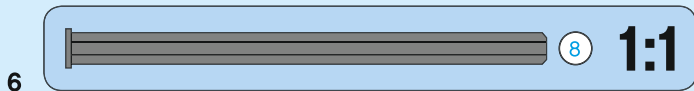
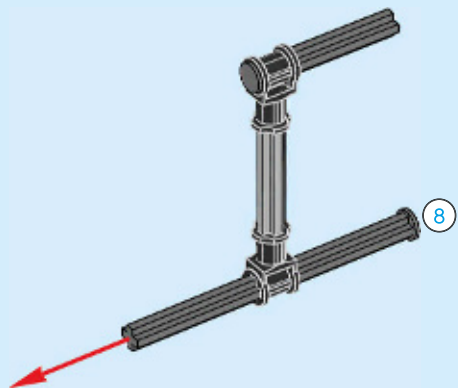

53

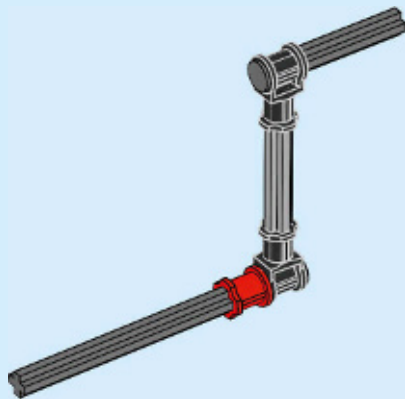



1x



2x

54

1

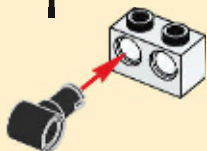

2

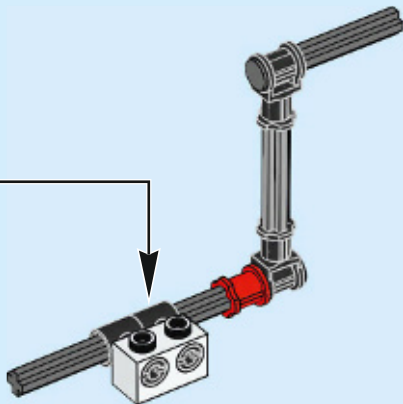

1x

55

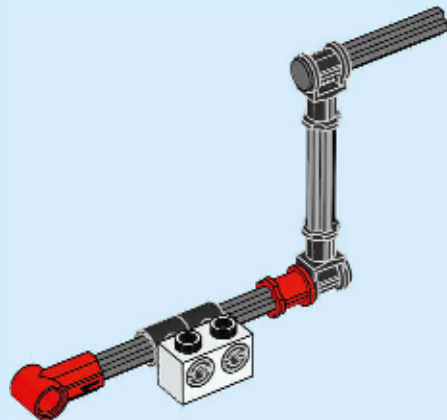

56

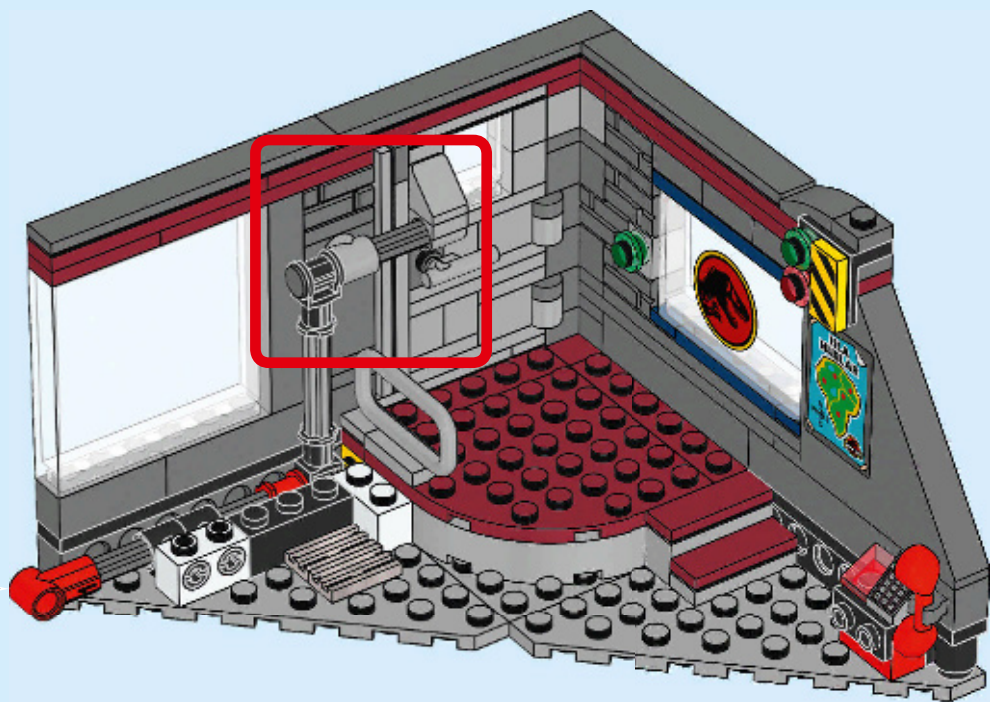



1x



1x

57

1

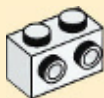

2

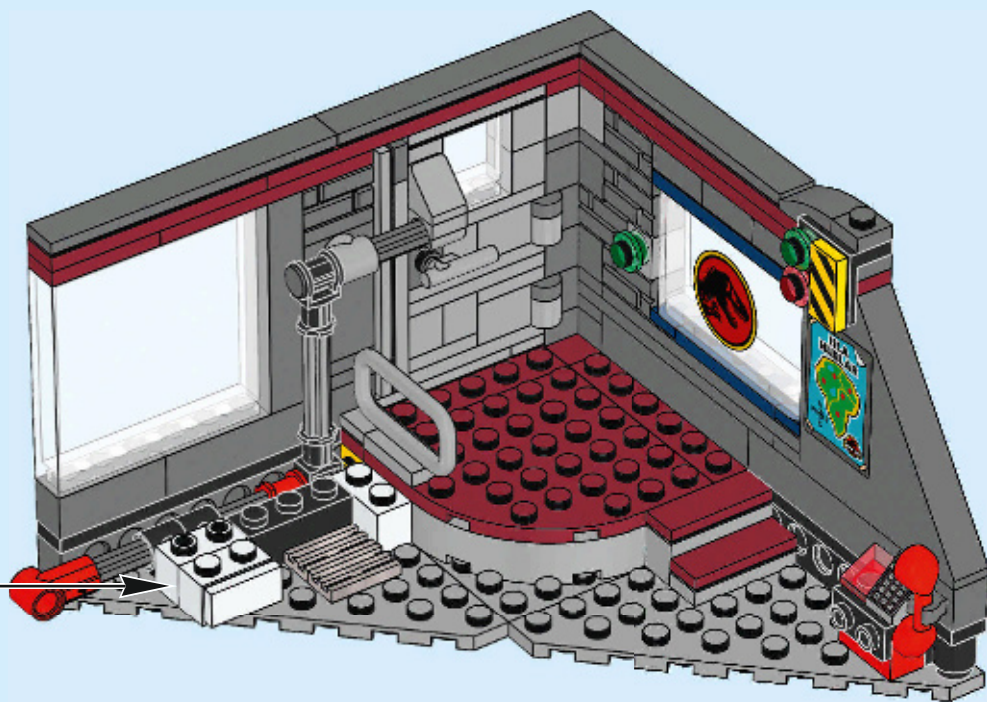

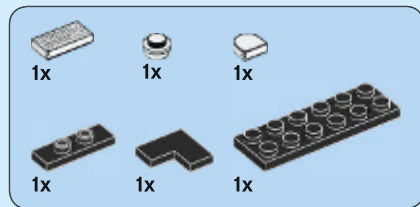

58

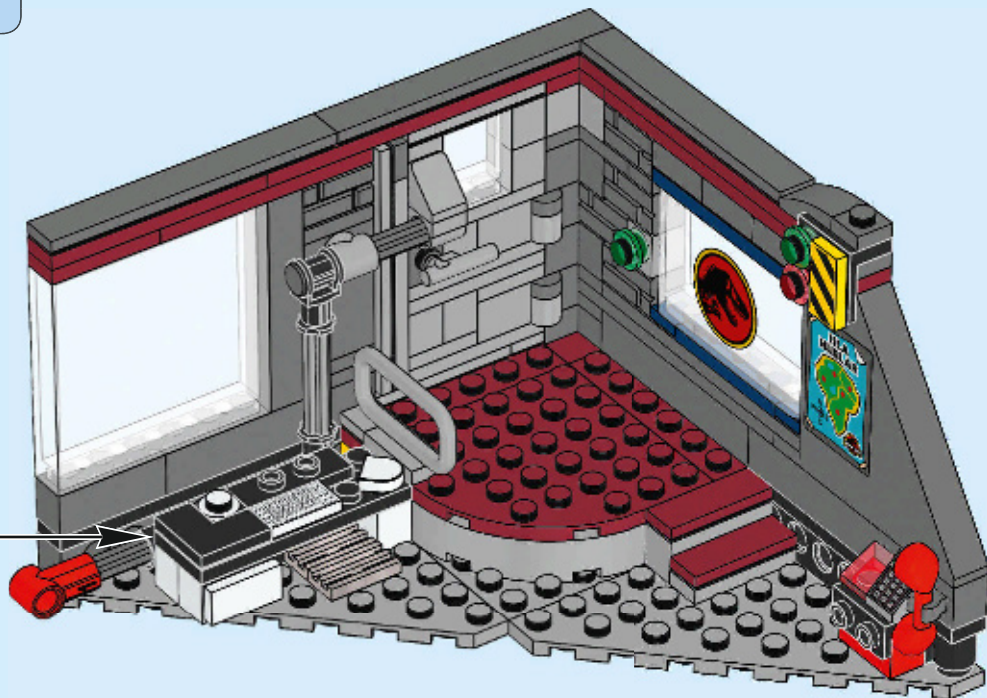
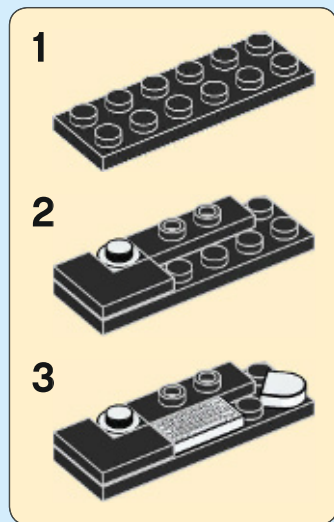



1x



1x

59

1

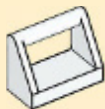

2



3

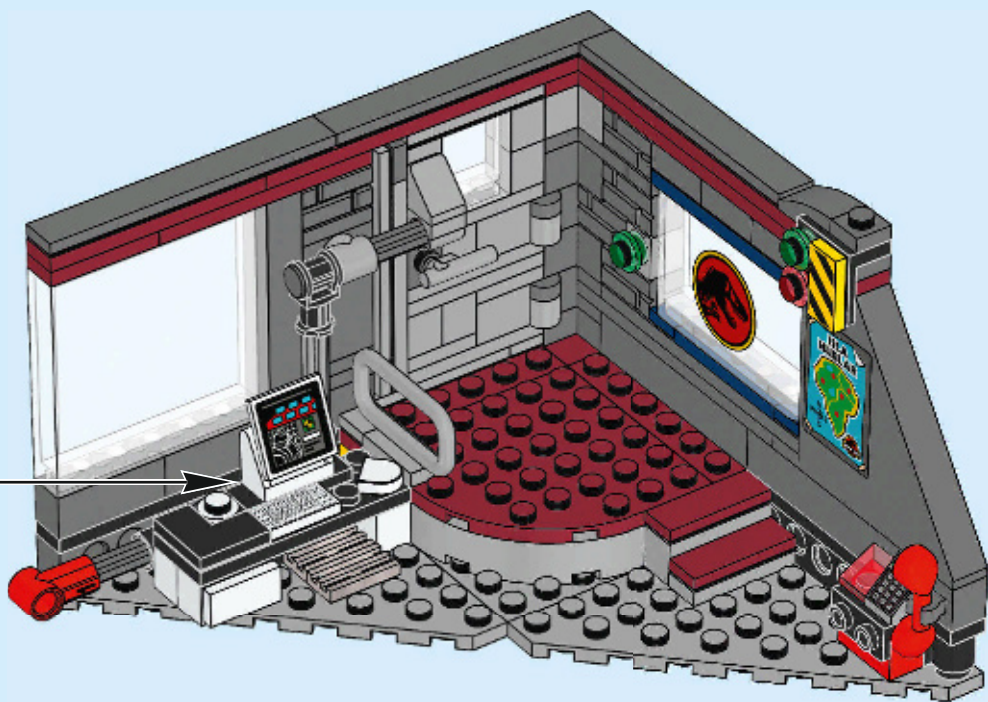



1x



1x

60

1

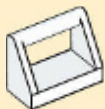

2



3

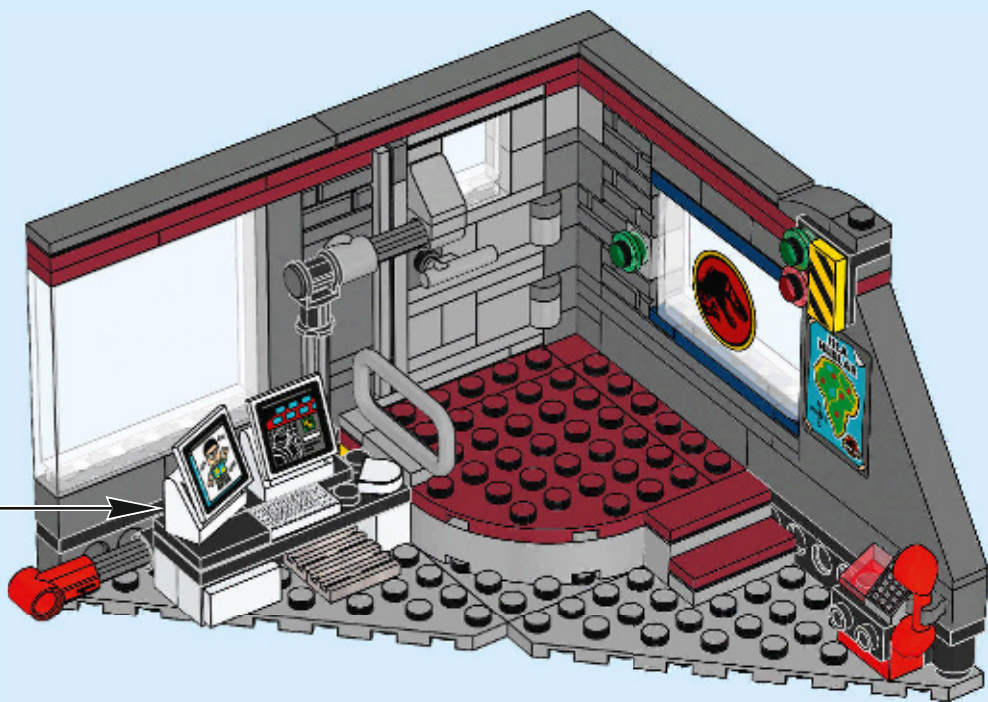



61

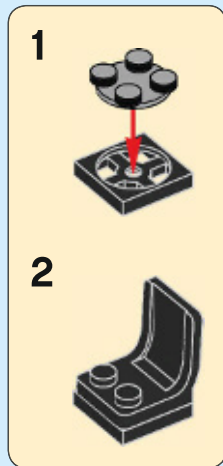

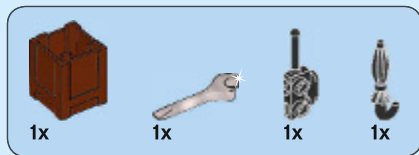

62



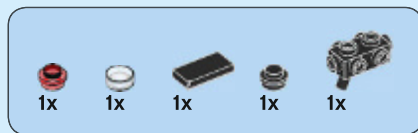

63

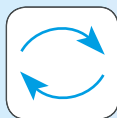
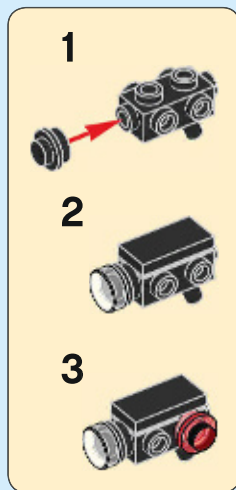

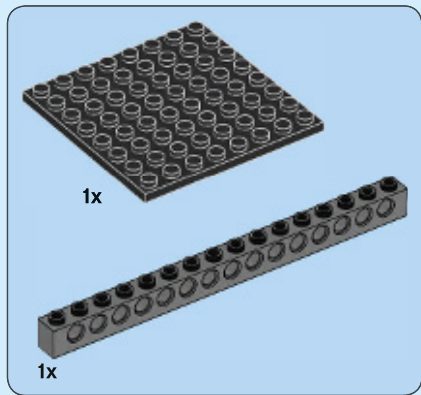
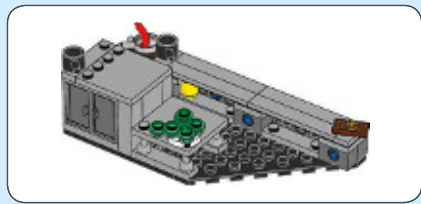

64

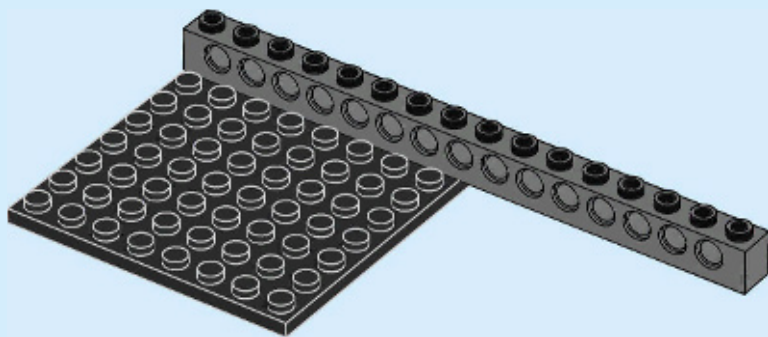

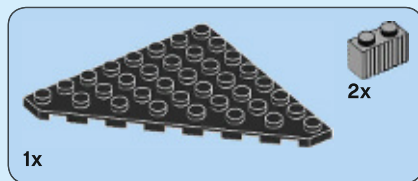

65

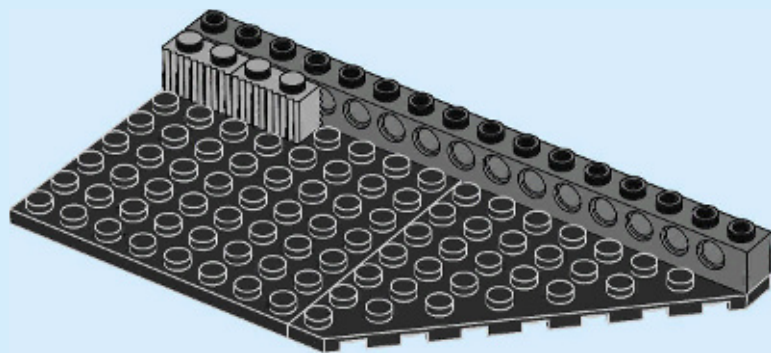



2x



2x

66

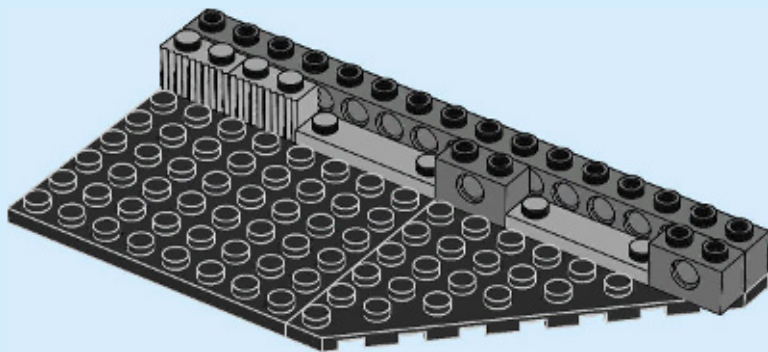



2x



2x

67

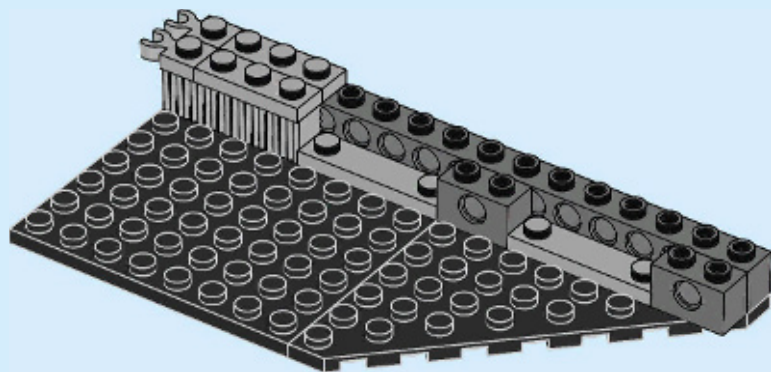



1x



2x



2x

68

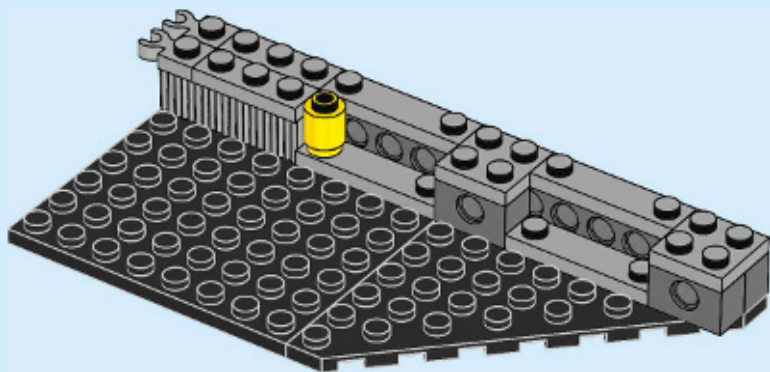

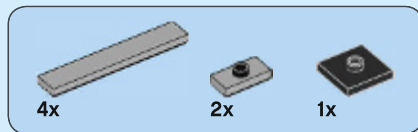

69

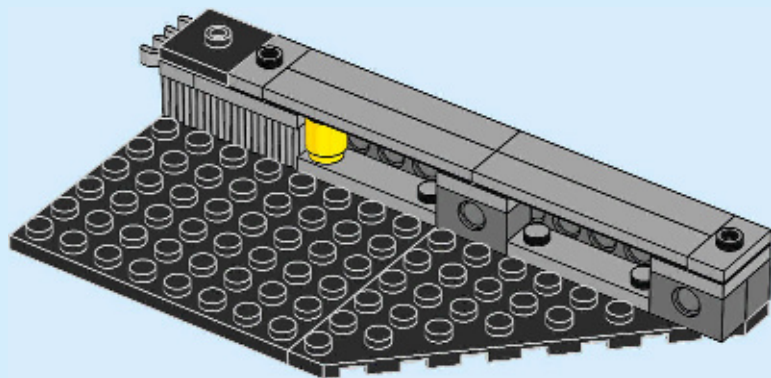



2x



2x

70

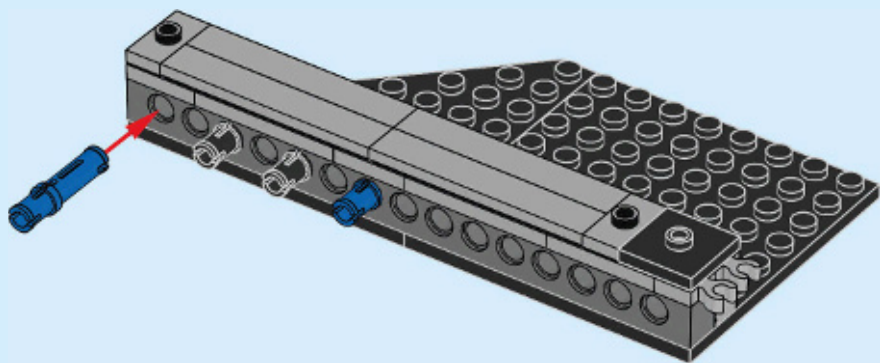
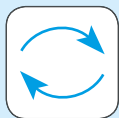



2x

71

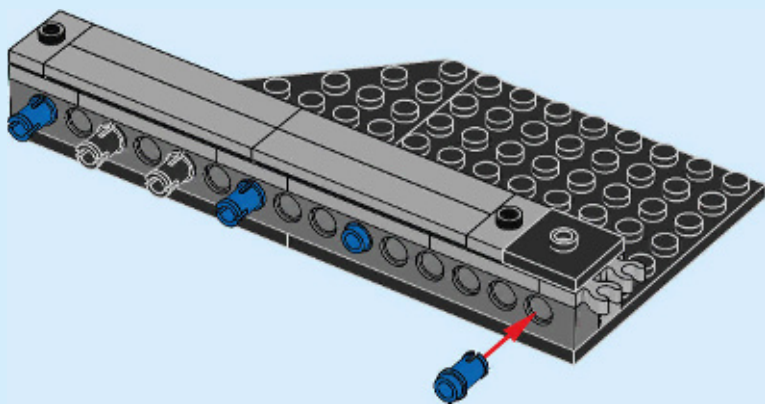

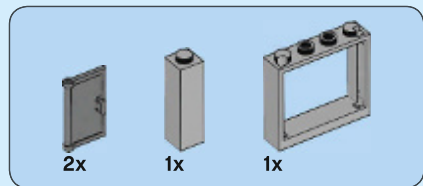

72

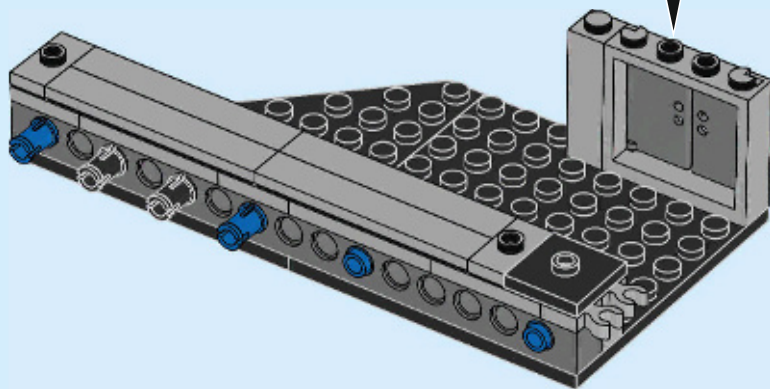
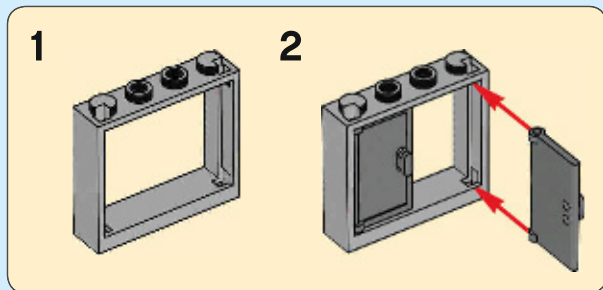

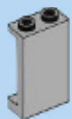

2x



1x

73

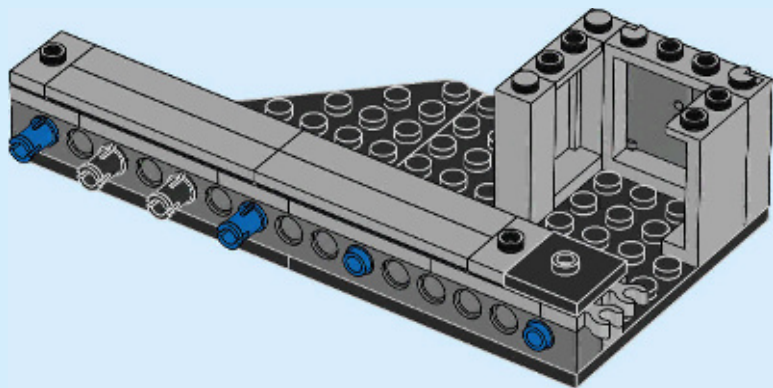

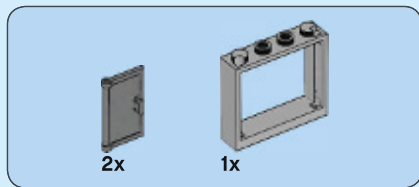

74

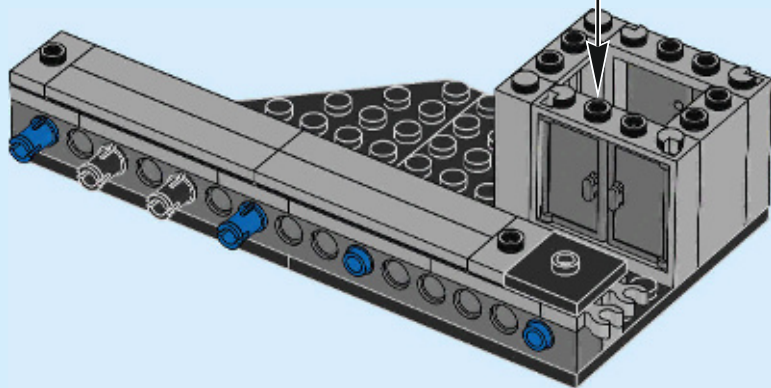
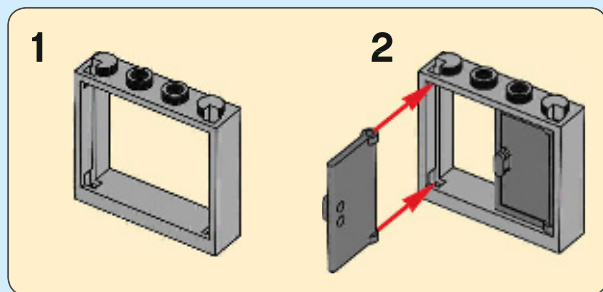

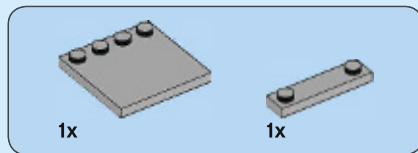

75

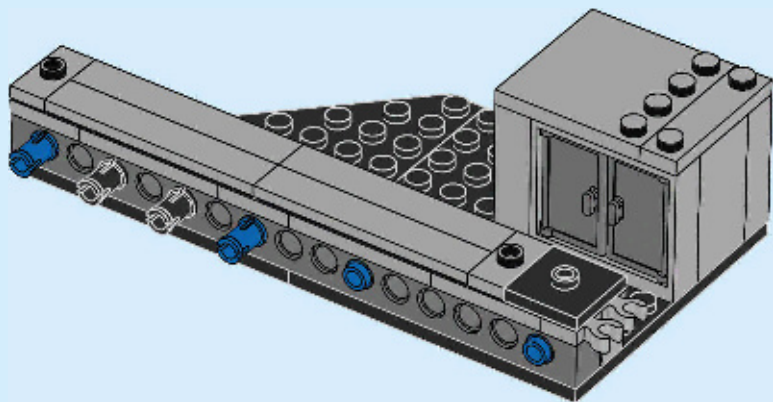

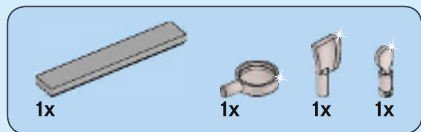

76

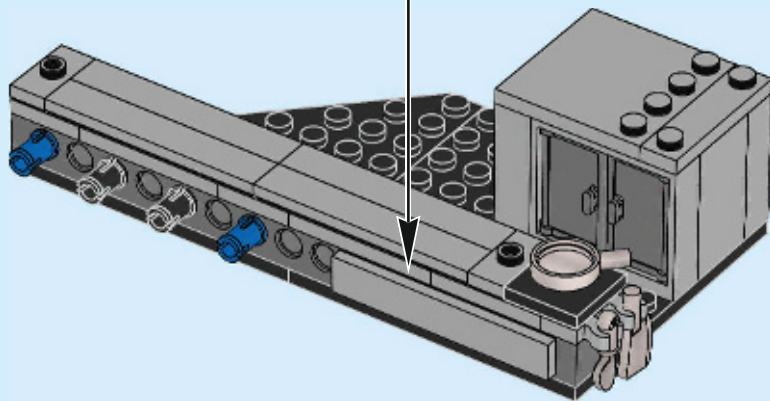
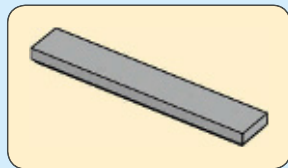



2x



1x

77

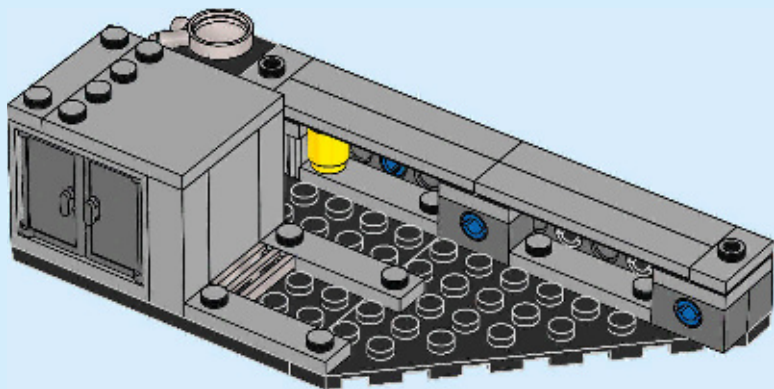
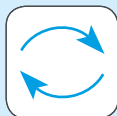



78

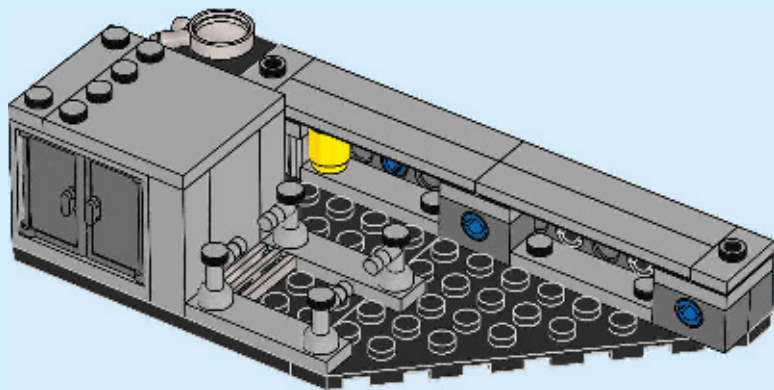

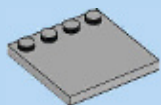

1x

79

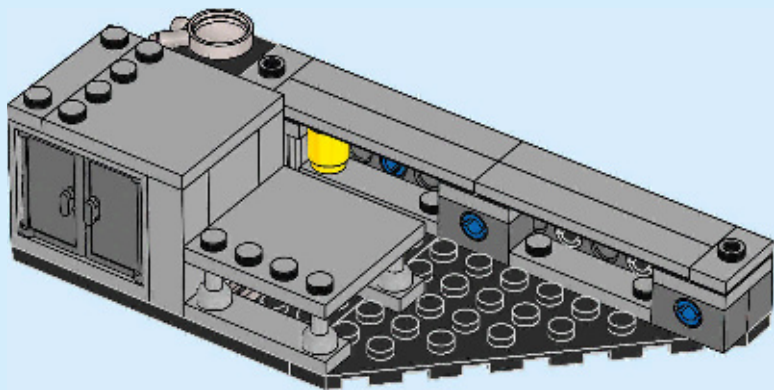



1x



7x

80

1



2



3

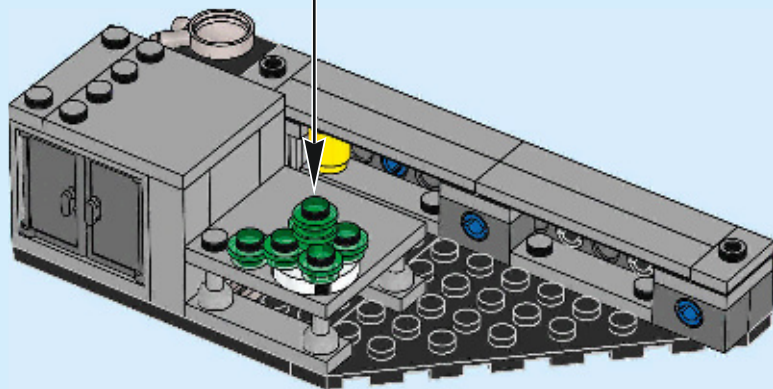
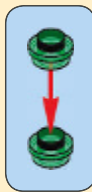



2x



1x



1x

81

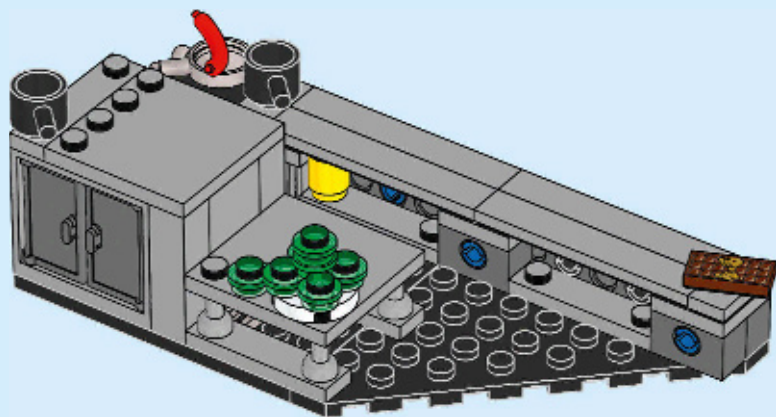

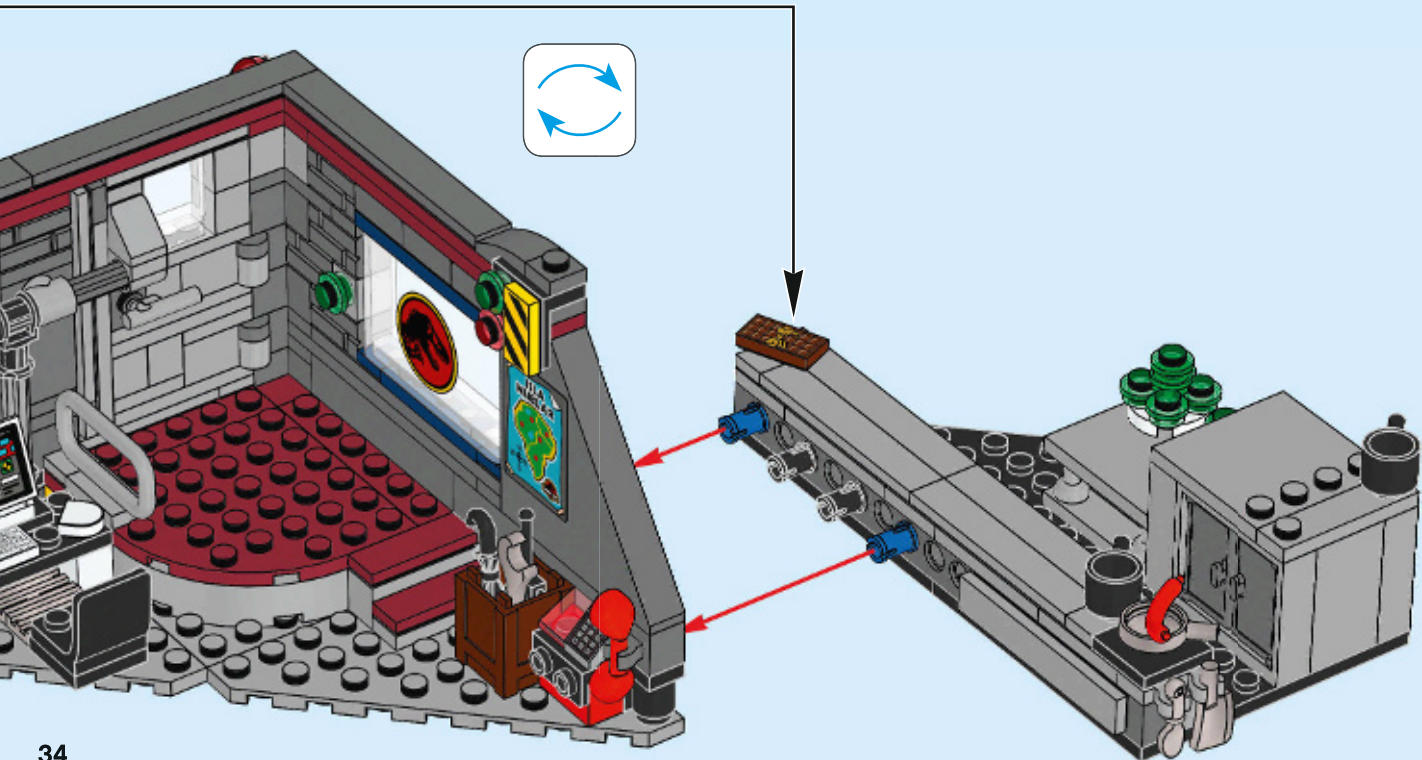

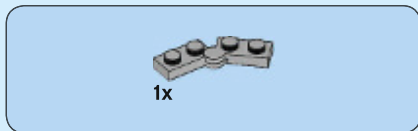

1

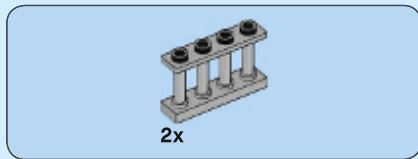

2

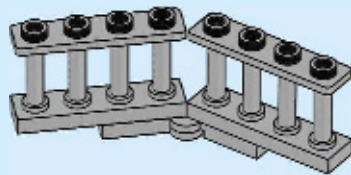

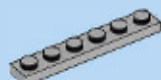

2x

3

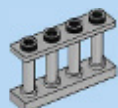
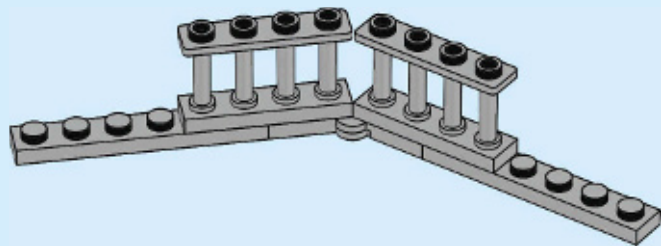

2x

4

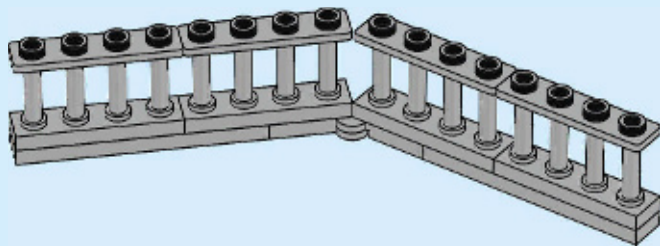



1x

5

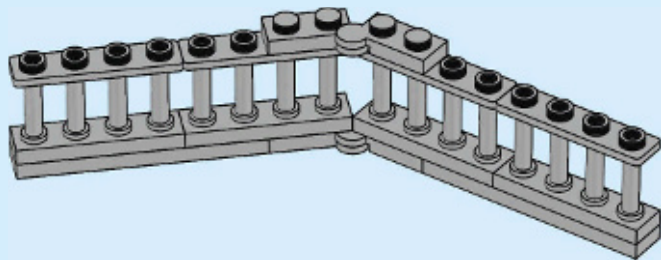

2x

6

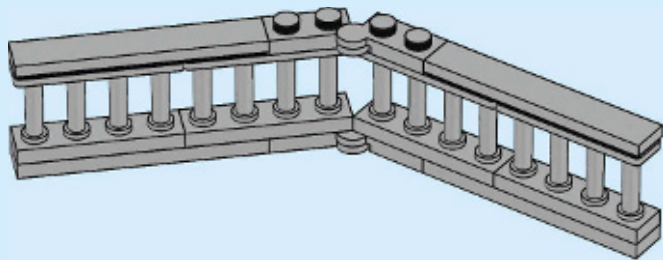



1x

7

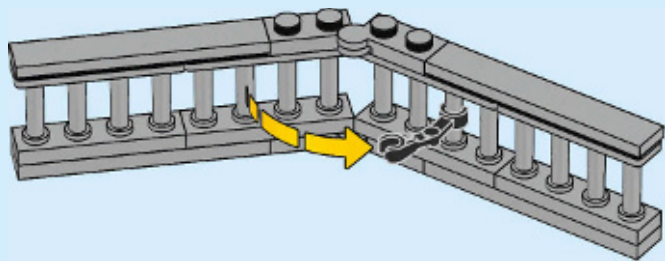

8

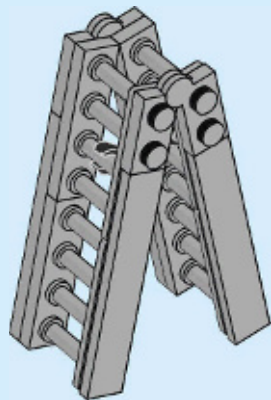
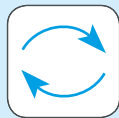



+

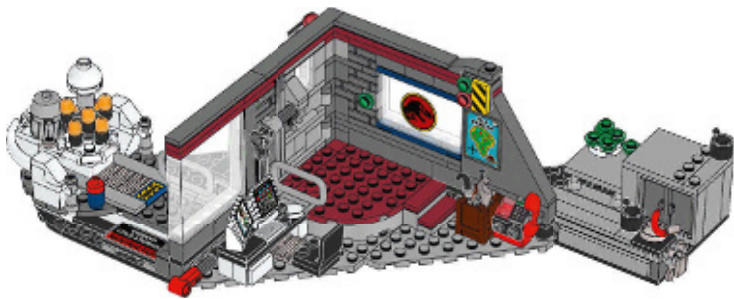

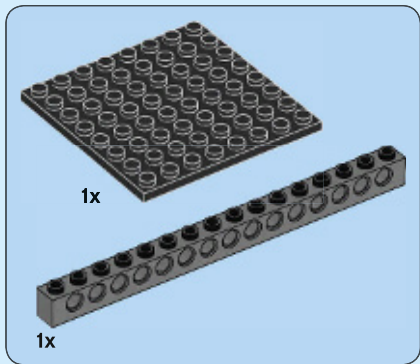
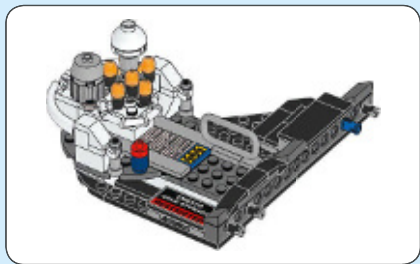

83

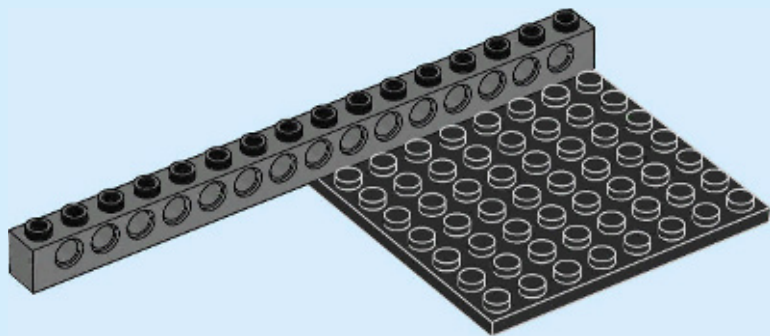

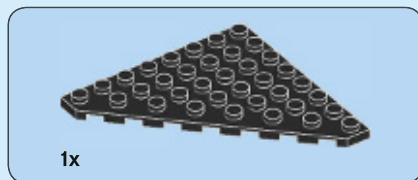

84

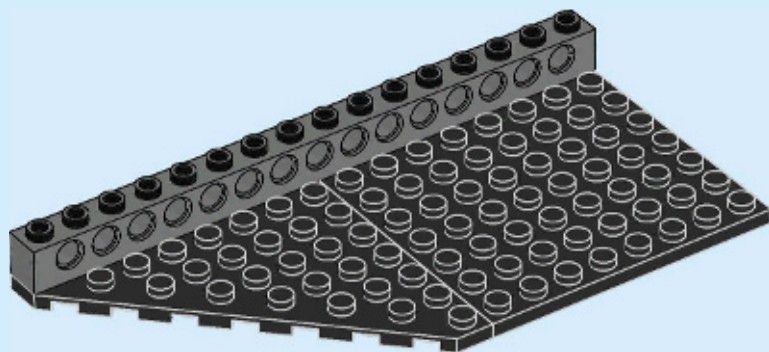



2x



1x

85

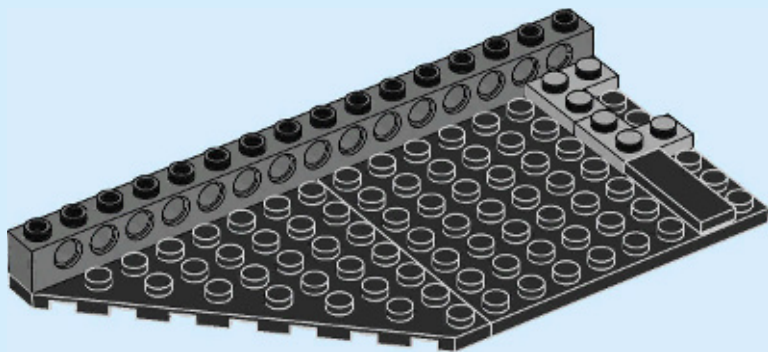

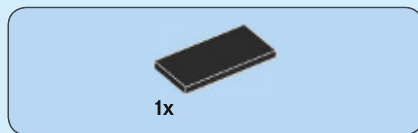

86

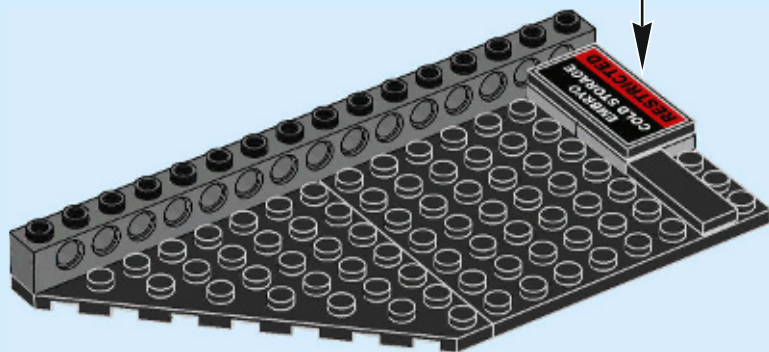

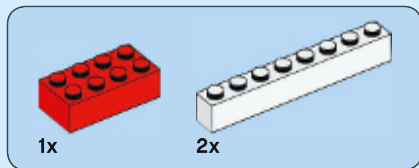

87

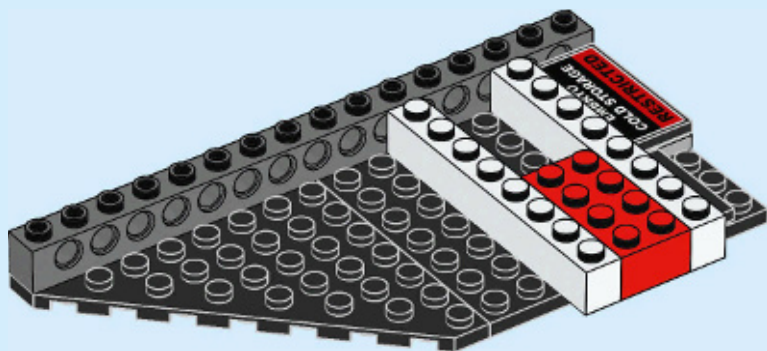

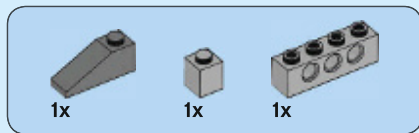

89

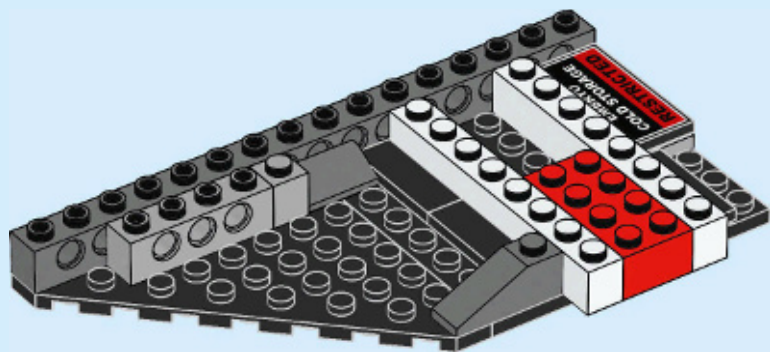



1x



1x

90

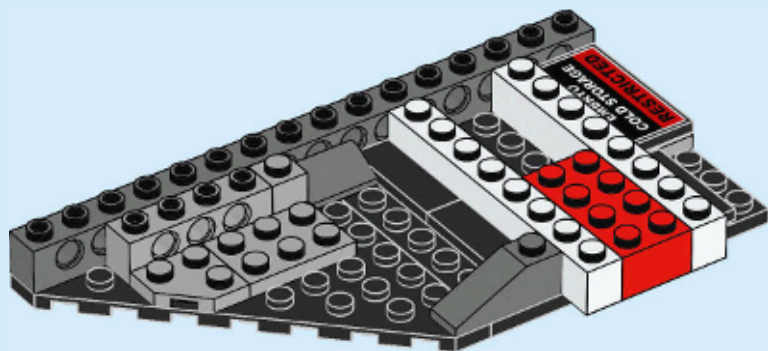

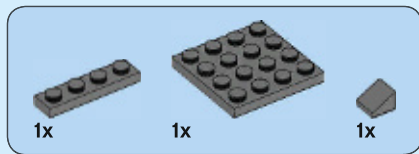

93

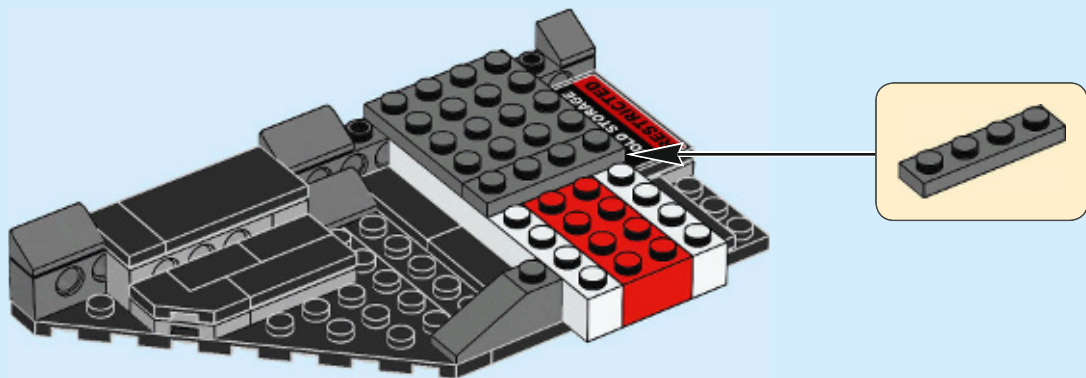



1x



2x



1x

94

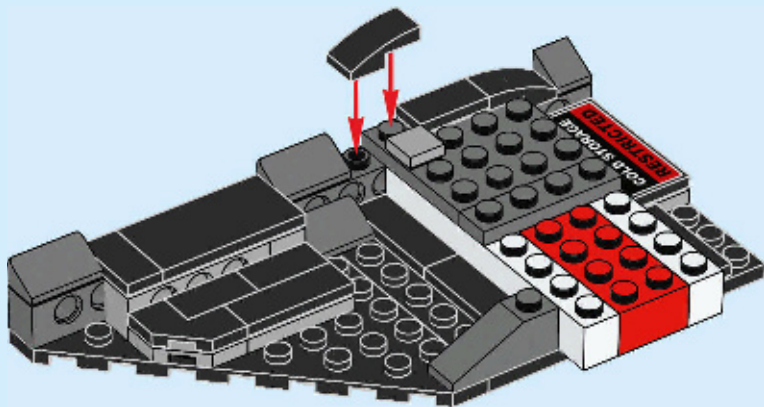



2x

96

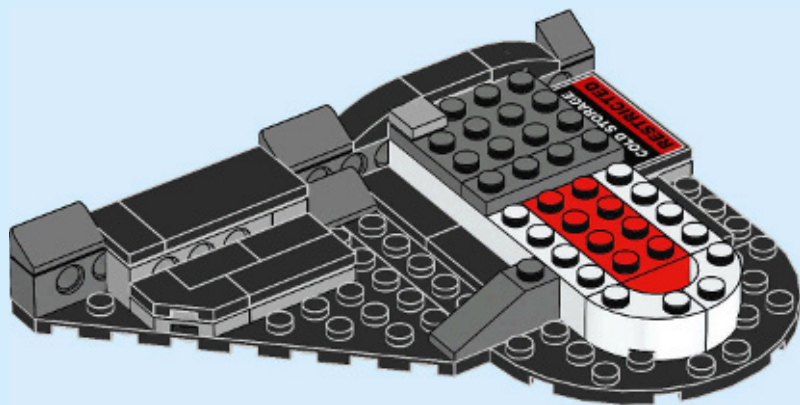



3x

97

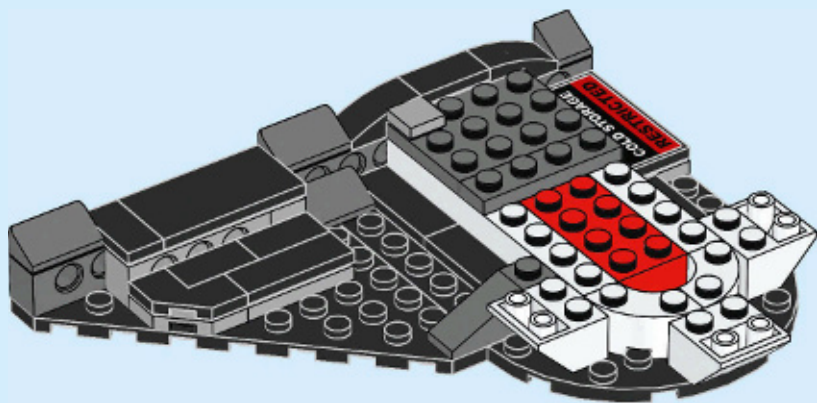



2x

98

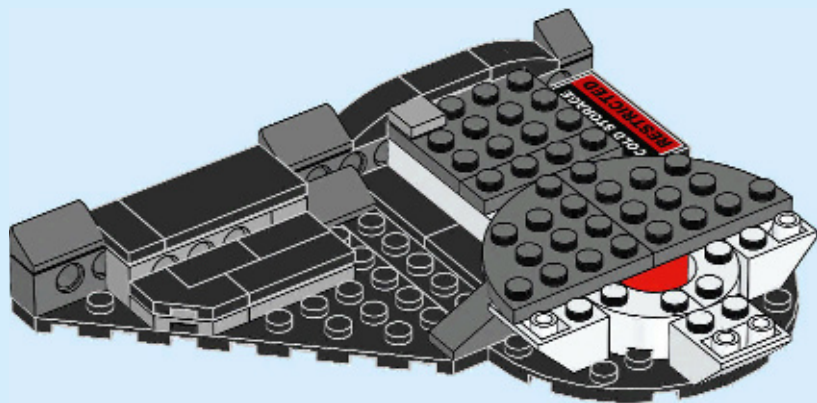



2x

99

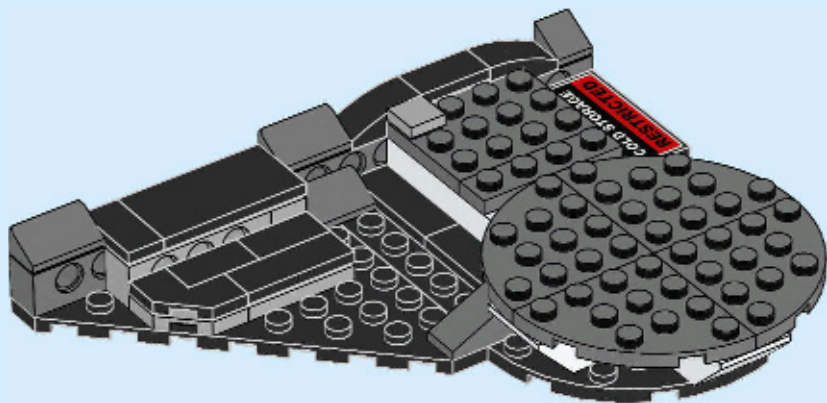



3x



1x

100

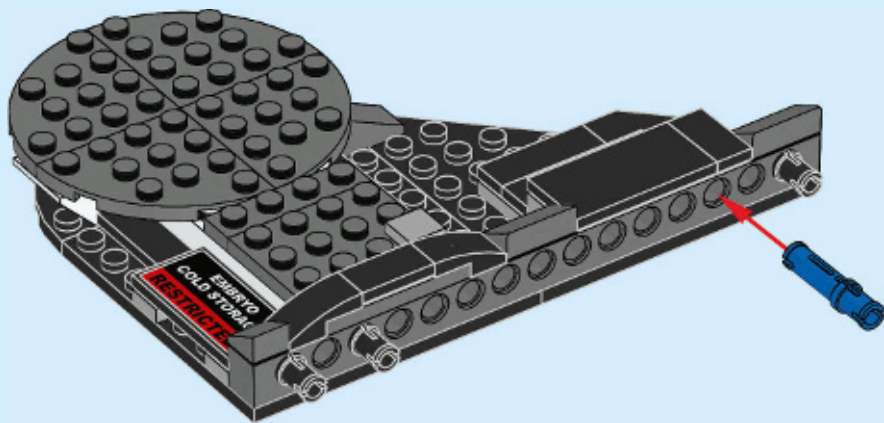
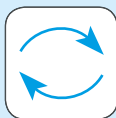

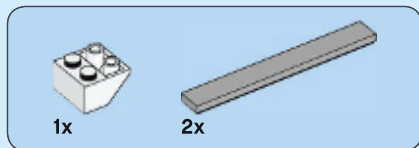

101

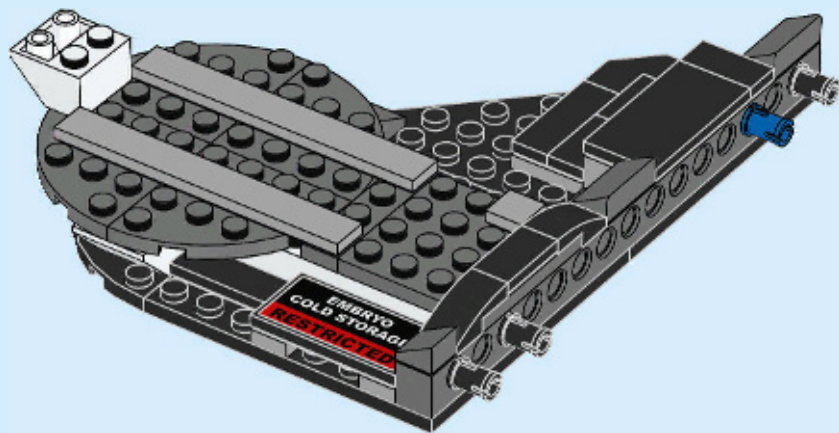

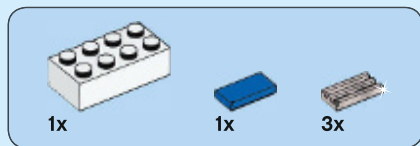

102

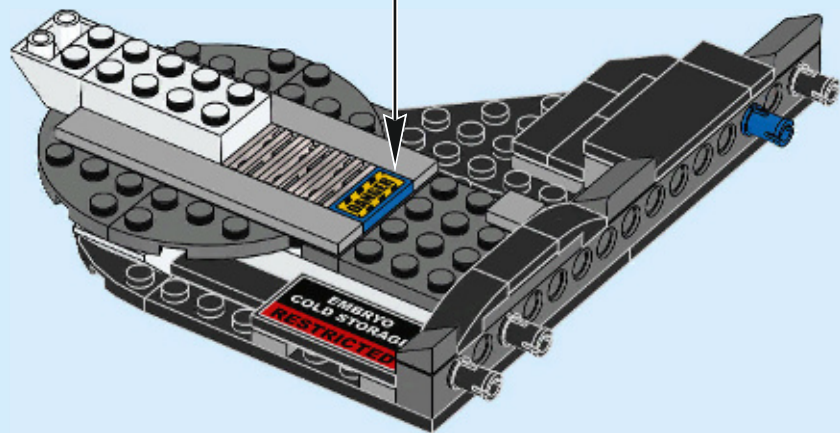



2x



1x

103

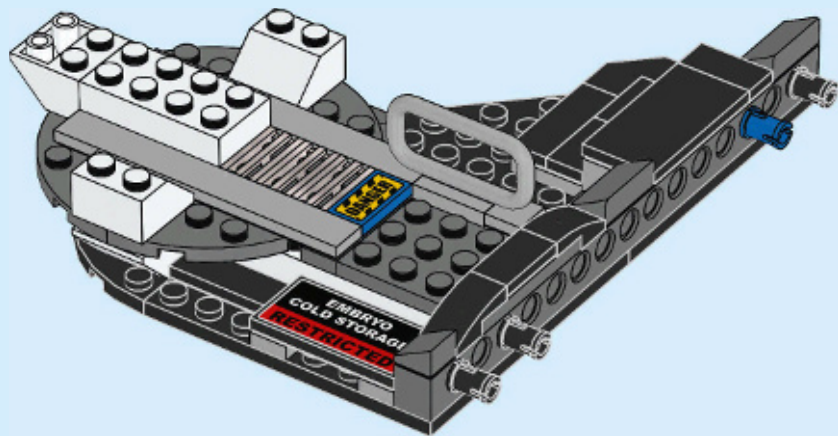



1x



1x



2x

104

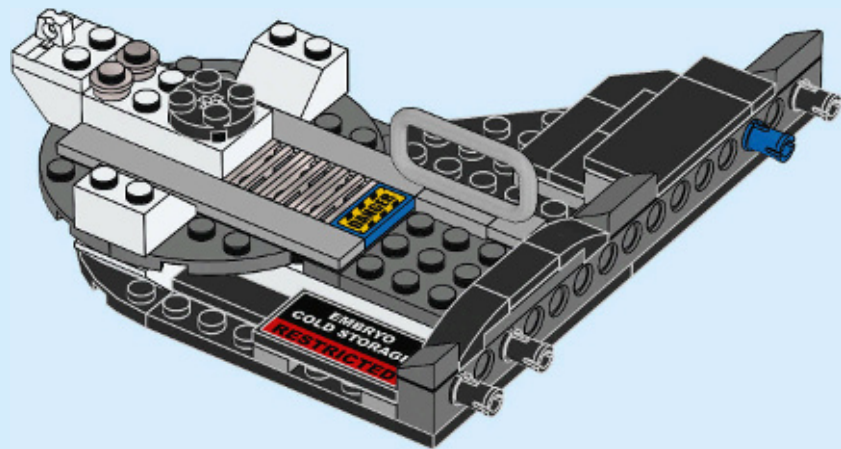



2x



2x



2x

105

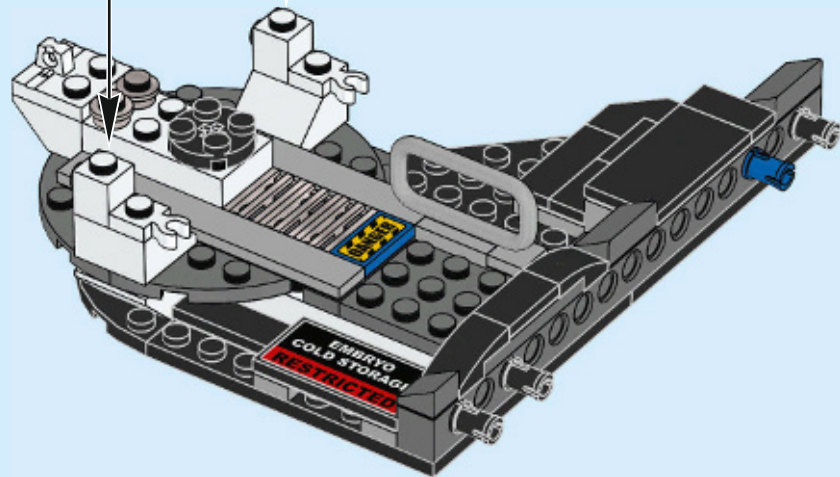



2x

106

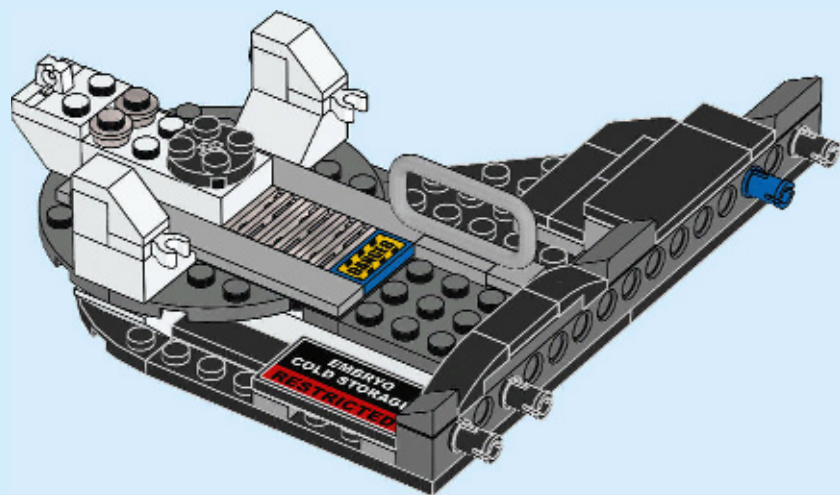



2x



2x

107

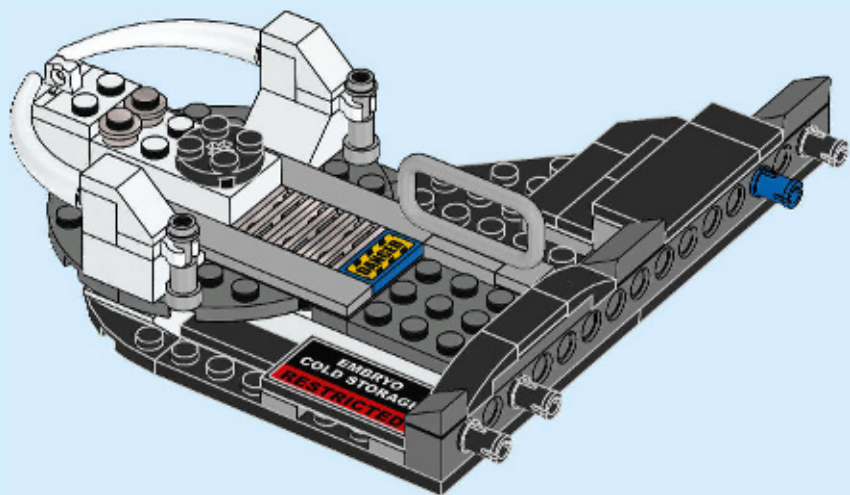



1x



1x



1x

108

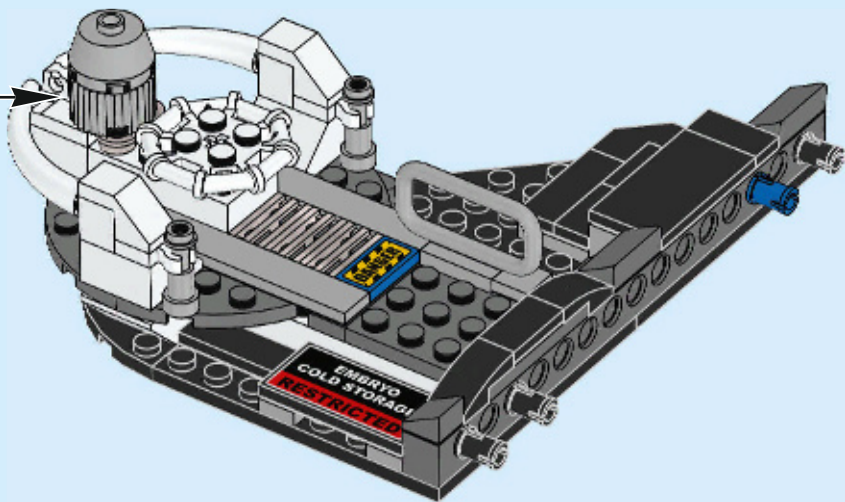
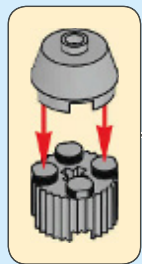



1x



1x

109

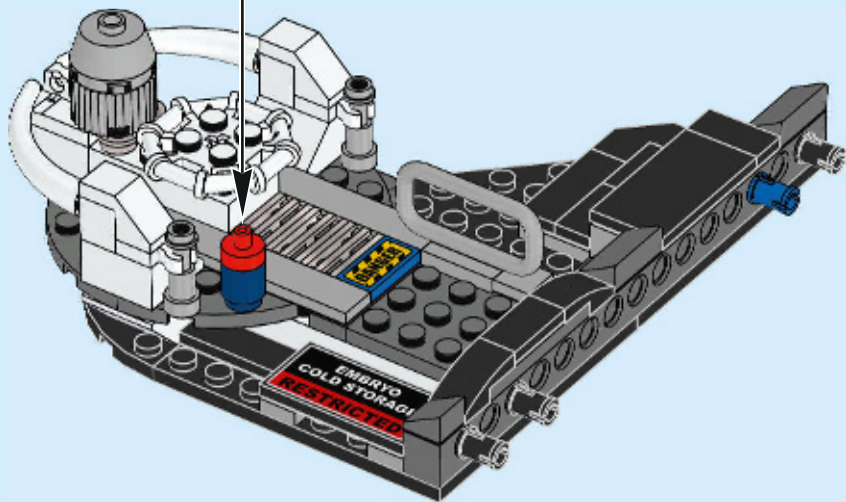
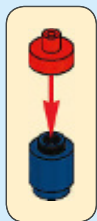



1x

110



4x

111

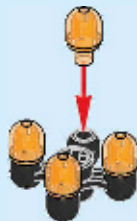



1x

112

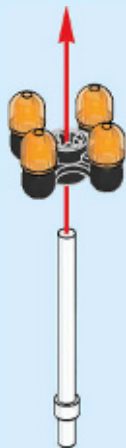

1x



4x

113

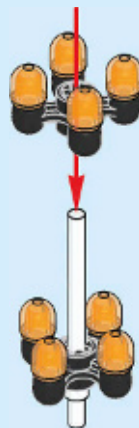

1



2





1x

114

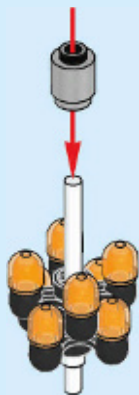

1x



1x

115

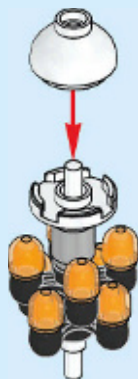



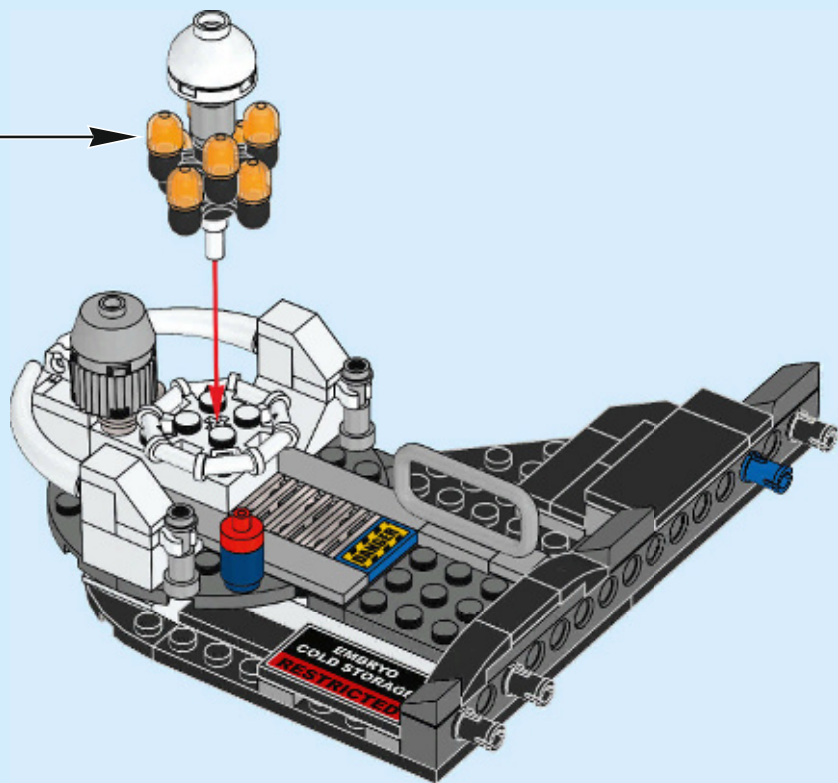

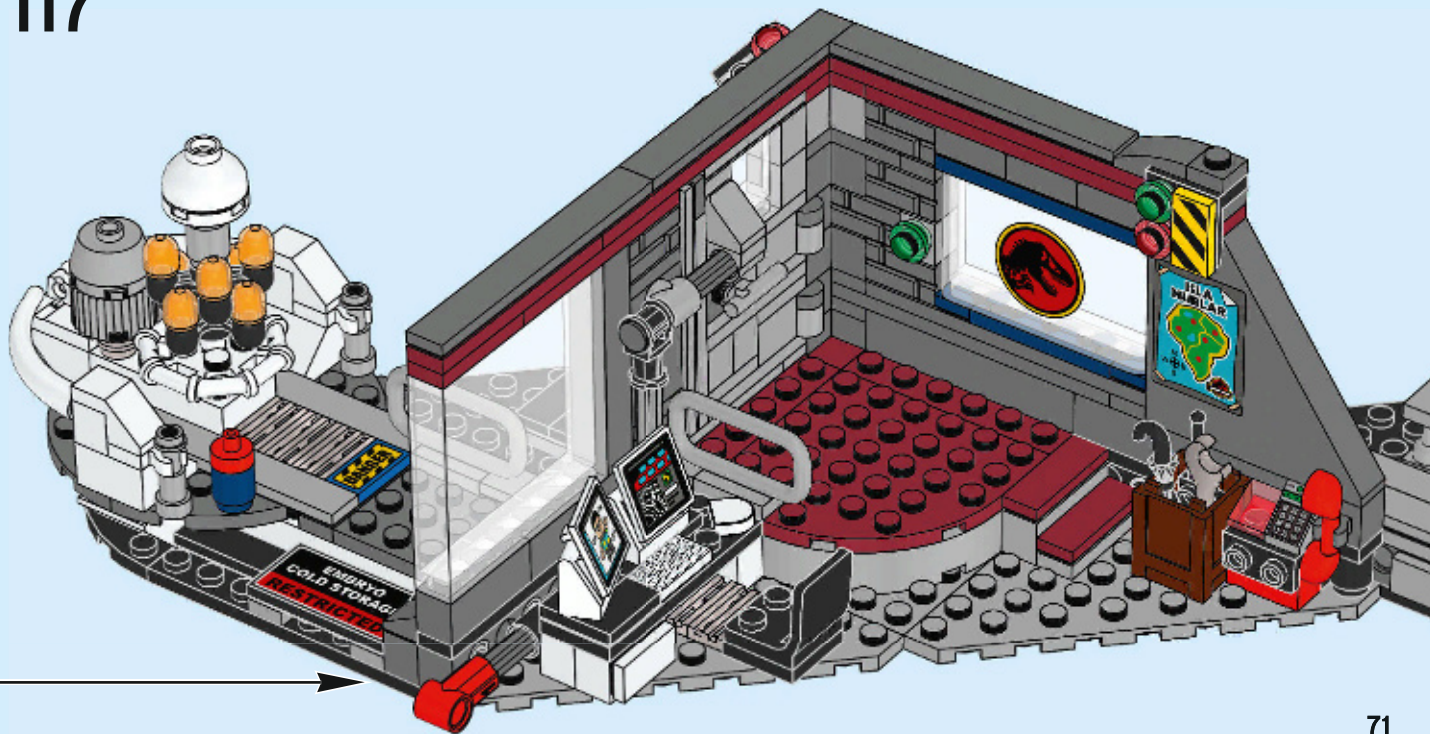

116

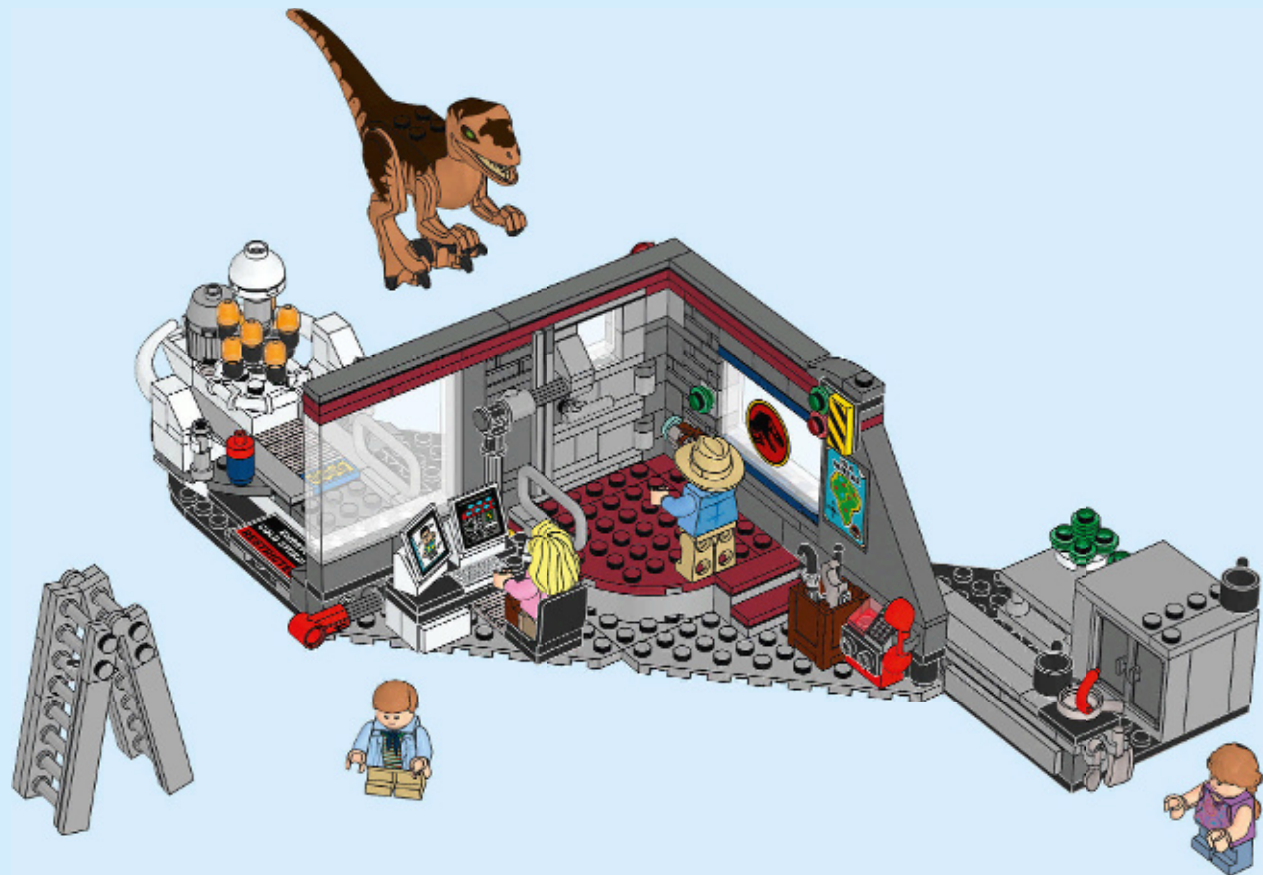

117





 1x 614101	 2x 243201	 1x 6009016	 1x 6215539	 1x 6226803	 1x 6227094
 1x 6131655	 1x 4293350	 1x 300101	 1x 4254606	 1x 6226739	 1x 6234383
 2x 4558952	 2x 6166894	 1x 6081986	 1x 4227155	 1x 6227099	 1x 6234401
 2x 6046383	 1x 306901	 2x 6110023	 1x 6144805	 1x 6227612	 1x 6227095
 2x 4613256	 1x 4613762	 2x 300801	 1x 300421	 1x 6226914	 1x 6234314
 1x 403201	 2x 300301	 1x 4507055	 1x 4558598	 1x 6227203	 1x 6234263
 1x 6050914	 2x 4567449	 1x 4107623	 1x 300121	 1x 6227101	 1x 6227170
 1x 6093053	 2x 303901	 1x 4540107	 2x 4143005	 1x 6227623	
 1x 3200001	 4x 366001		 1x 306923		
 1x 6058177			 3x 4514553		



1x
4550169



1x
4585751



1x
4539076



2x
4583299



2x
4539062



2x
4618986



1x
6227518



3x
6037995

74



1x
6227252



1x
4650498



1x
6000740



1x
4546690



1x
4504229



1x
4177741



2x
4631385



1x
6036240



1x
4508313



1x
306224



1x
4624985



1x
6129504



1x
306226



1x
614126



1x
6171840



2x
6073231



1x
403226



2x
452926



6x
4121715



2x
4107081



2x
6047276



1x
4223247



5x
306926



1x
6016172



1x
6117973



1x
6051527



2x
4248204



1x
4565323



1x
368026



1x
6133722



1x
6166859



1x
407926



1x
6199908



1x
362226



4x
4558170



1x
6170545



2x
4560182



1x
379526



2x
346026



1x
370226



1x
6133200



2x
4166619



2x
4205347

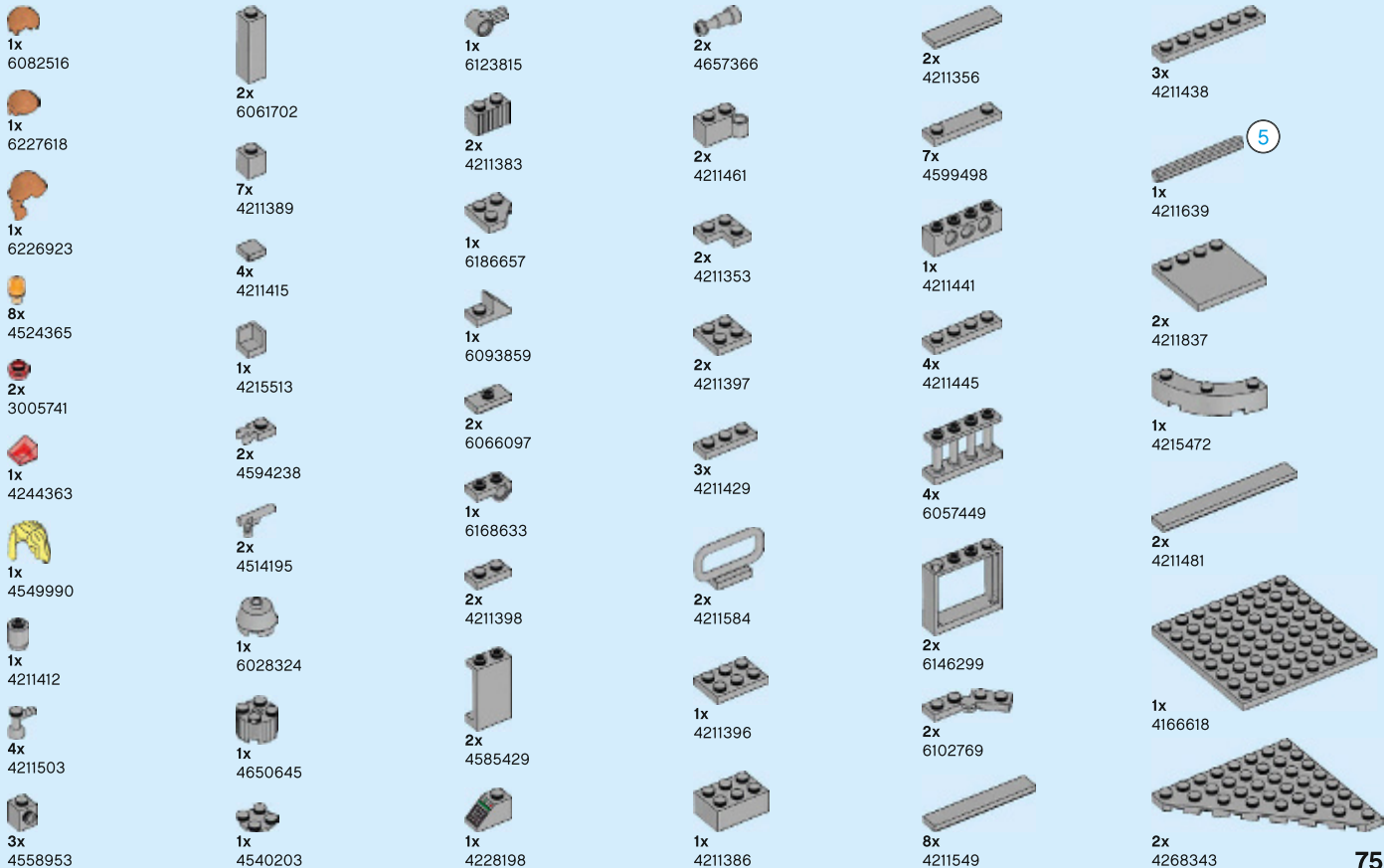

5



2x
4624705



1x
6114374



1x
6139435



1x
4520638



6x
4163917



9x
3005748



2x
4633691



1x
6196796



1x
6153590



1x
4624615



6x
4619636



1x
6167576



1x
6195518



1x
6121893



8x
4210719



1x
4504378



1x
4210700



1x
4580437

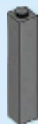

1x
4210690



4x
4521386



6x
4567887



1x
4210978



2x
4211111



5x
6000311



2x
6011461



5x
4211063



1x
6178919



1x
6029948



3x
4211109



1x
4211104



1x
4211045



1x
6083620



1x
4211001



4x
4211100



1x
4243831



4x
4222042



1x
6227519



1x
4499858



2x
4210998

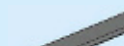

3x
4211008



3x
4256828



Customer Service

Kundenservice

Service Consommateurs

Servicio Al Consumidor

LEGO.com/service or dial



00800 5346 5555 :



1-800-422-5346 :



4

8



CITY



60170



60171



60176



60172



60173



60174



COLLECT THEM ALL!

SAMMLE SIE ALLE! / COLLECTIONNE-LES TOUS!
COLLEZIONALI TUTTI! / ¡COLECCIONALOS TODOS! / COLECIONA-OS TODOS!
GYŰJTSD ÖSSZE MINDET! / 集齐所有恐龙!

75929
75930



75926



75930



75927



75928
75930



75929



75929



75930



75929



BUILD YOUR OWN HYBRID!

BAUE DEINEN EIGENEN HYBRID! / CONSTRUIS TON
PROPRE MODÈLE HYBRIDE! / COSTRUISCI IL TUO IBRIDO!
¡CONSTRUYE TU PROPIO HÍBRIDO! / CONSTRÓI O TEU HÍBRIDO!
ÉPÍTS SAJÁT HIBRIDET! / 拼出属于你自己的独特恐龙!



Jurassic World is a trademark and copyright of Universal Studios and Amblin Entertainment, Inc. Licensed by Universal Studios. All Rights Reserved.

75926



75930



75928



75929



75927



Jurassic World is a trademark and copyright of Universal Studios and Amblin Entertainment, Inc. Licensed by Universal Studios. All Rights Reserved.

WIN

GO TO WWW.LEGO.COM/PRODUCTFEEDBACK AND
GIVE US YOUR SHORT **FEEDBACK** ABOUT THIS
LEGO® SET FOR A CHANCE TO WIN
A COOL LEGO PRIZE.

Terms & Conditions apply

LEGO.com/productfeedback



GEWINNE

Erzähle uns auf
www.LEGO.com/productfeedback

etwas über die Erfahrungen, die du mit
diesem LEGO® Set gemacht hast, und
sichere dir die Chance auf einen coolen
LEGO Preis!

Es gelten die Teilnahmebedingungen

GAGNE

Rends-toi sur
www.LEGO.com/productfeedback

et donne-nous quelques commentaires sur
ce produit LEGO® pour avoir une chance
de gagner un prix LEGO !

Voir Conditions Générales

GANAN

Visita
www.LEGO.com/productfeedback

y envíanos tu opinión acerca de este set
LEGO®. ¡Participarás en el sorteo de un
premio LEGO!

Términos y Condiciones aplicables

获取奖品

登录
www.LEGO.com/productfeedback

给出关于此乐高®套装的简短反馈，
就有机会获得炫酷乐高奖品

《条款及条件》适用