



40370

40  
YEARS





40 years  
40 Jahre  
40 ans  
40 anni  
40 años  
40 anos  
40 év  
40 gadi  
40 周年

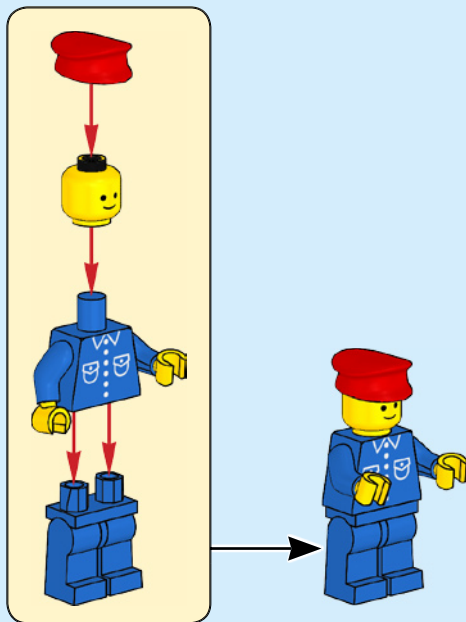

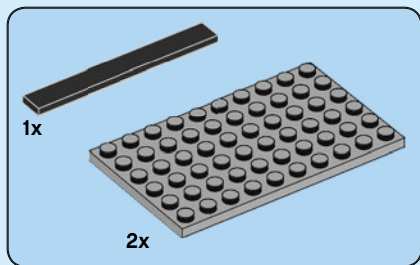
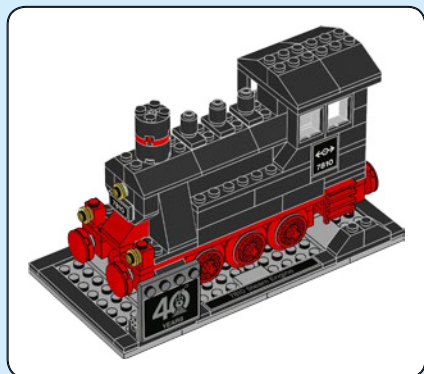

**1**

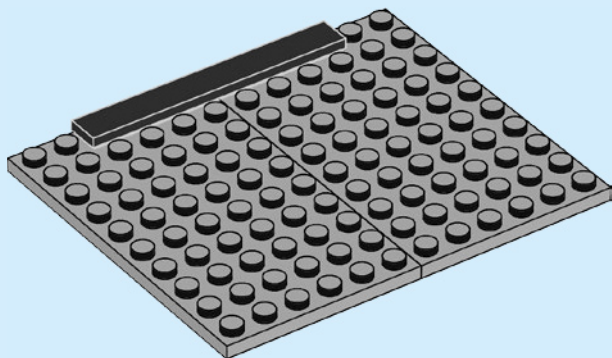

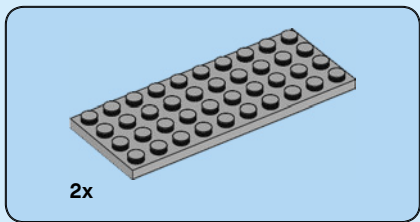

2

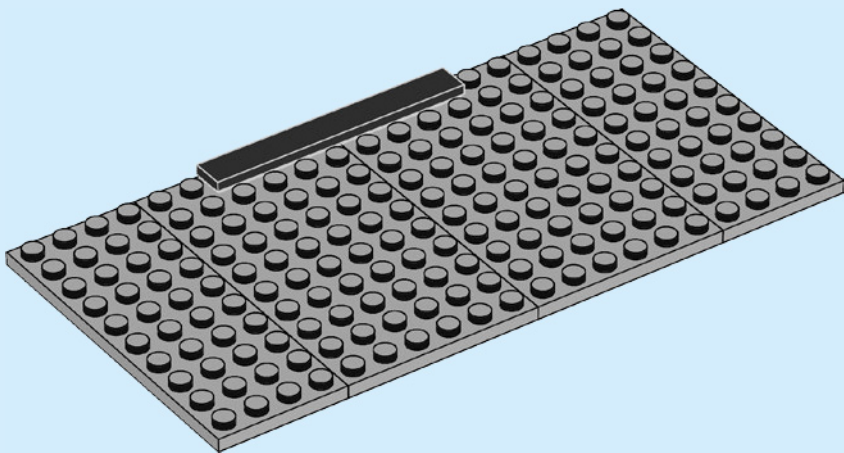

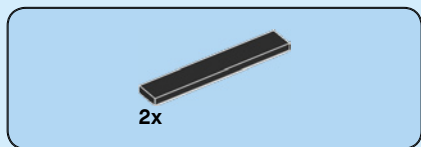

**3**

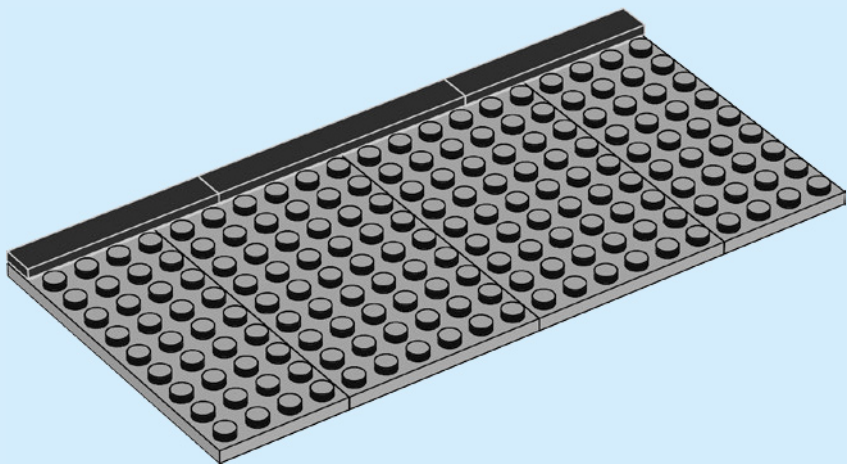

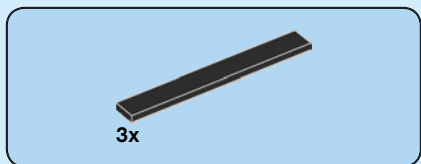

4

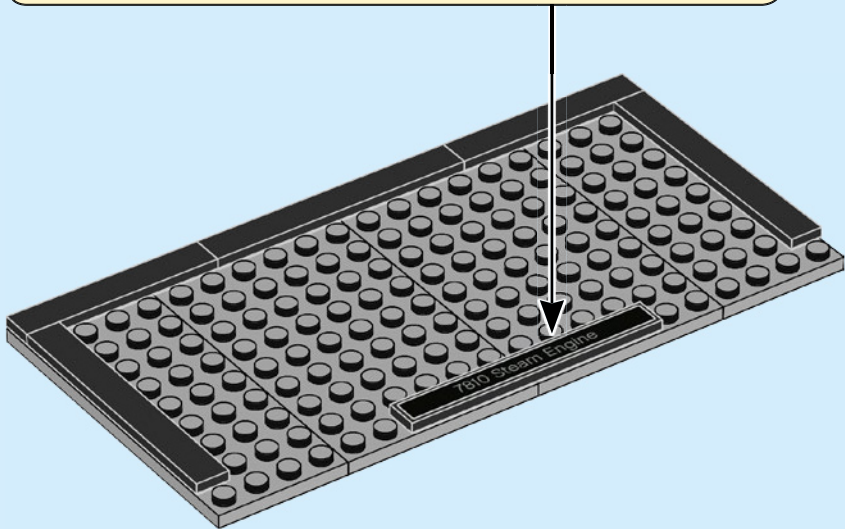
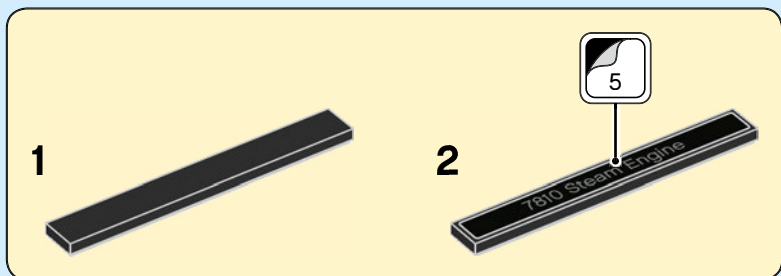

6

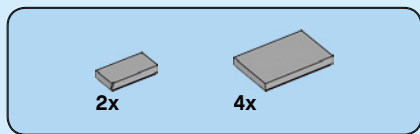

5

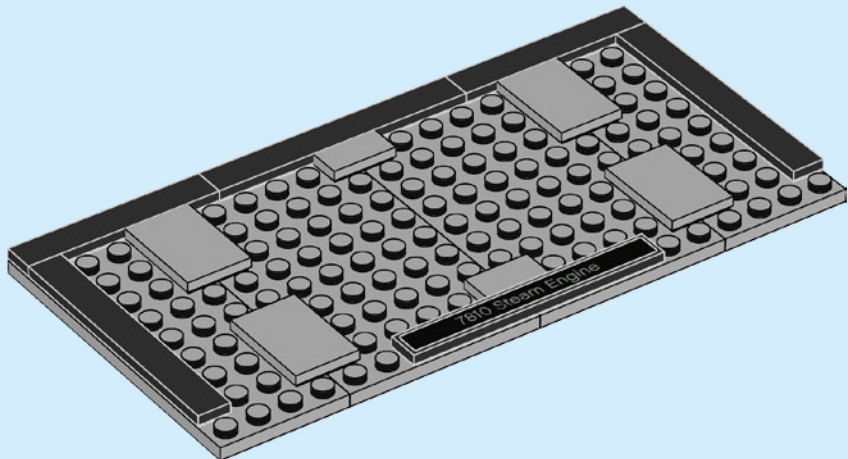



4x

6

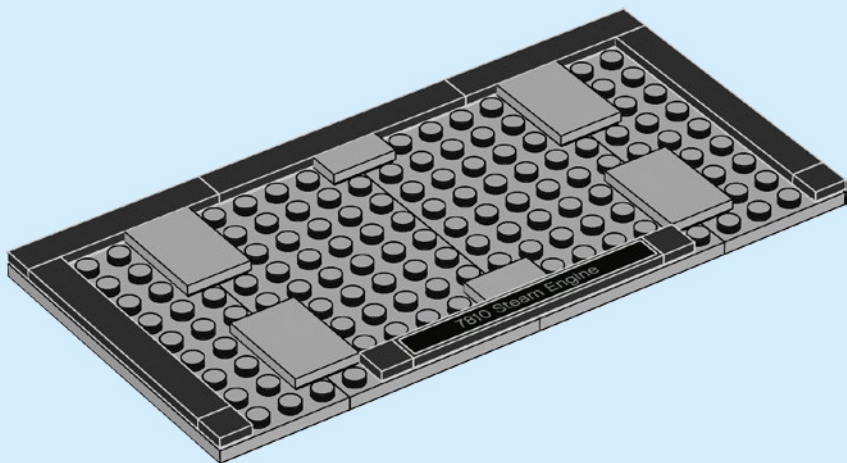

8



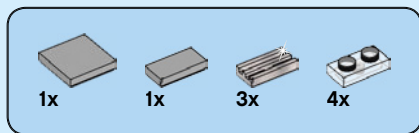

7

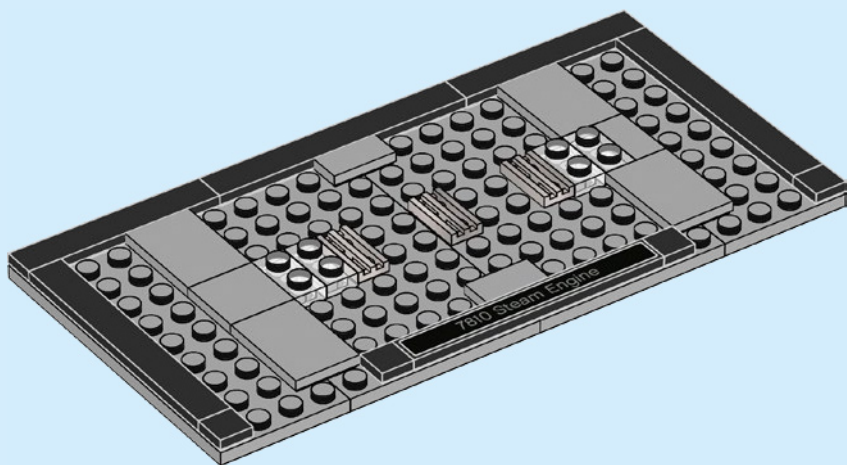



2x

8

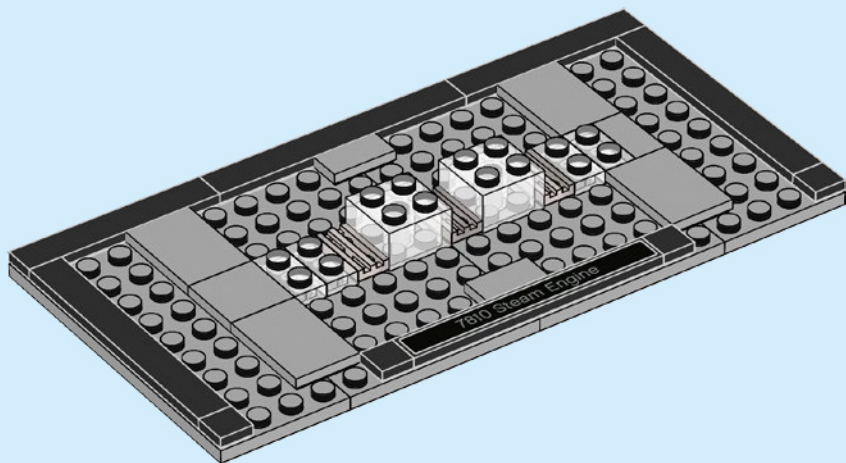



2x



2x

9

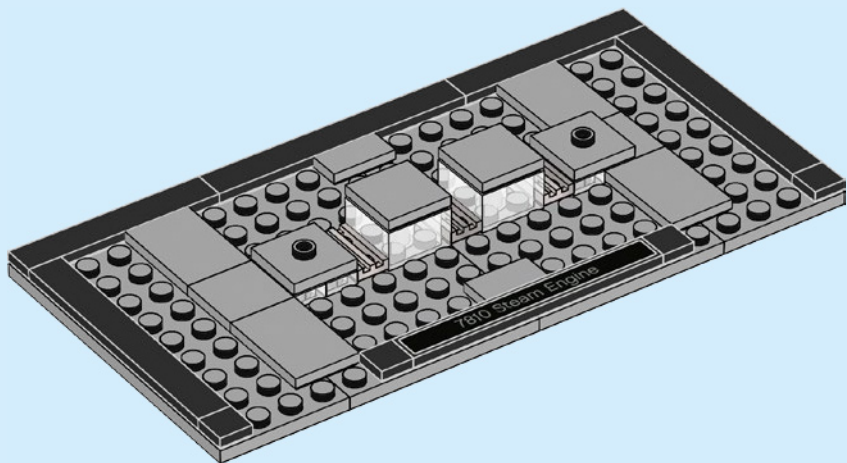



1x



2x

# 10

1

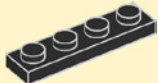

2

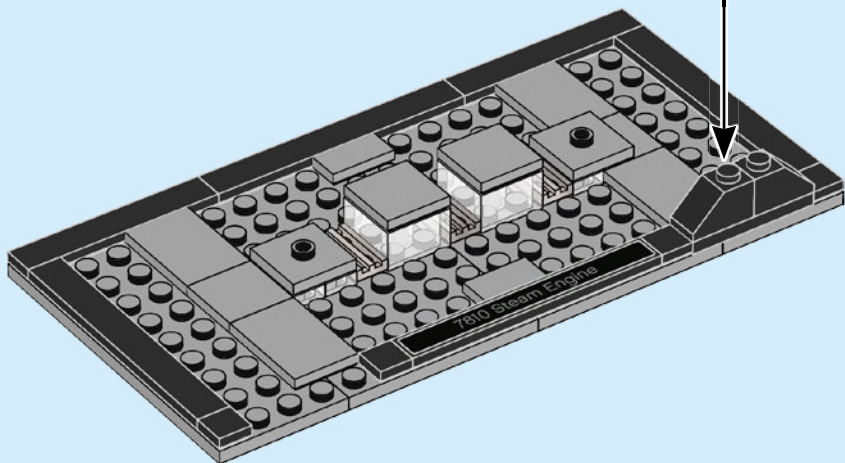
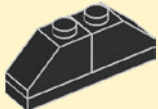

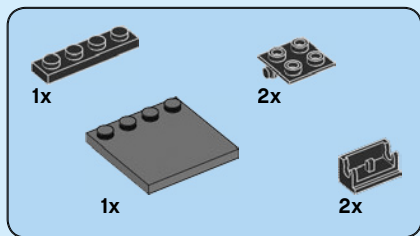

11

1

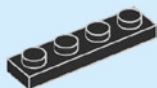

2

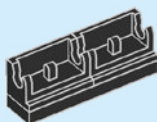

3

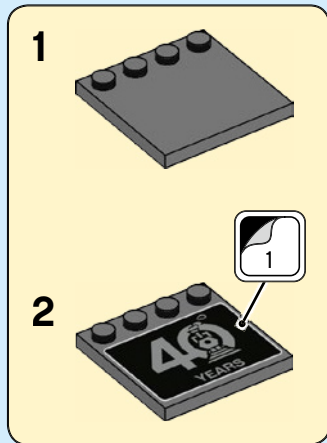
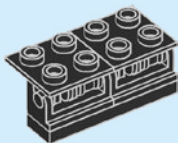

4

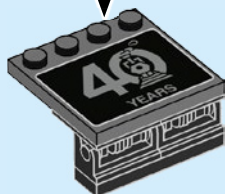

5



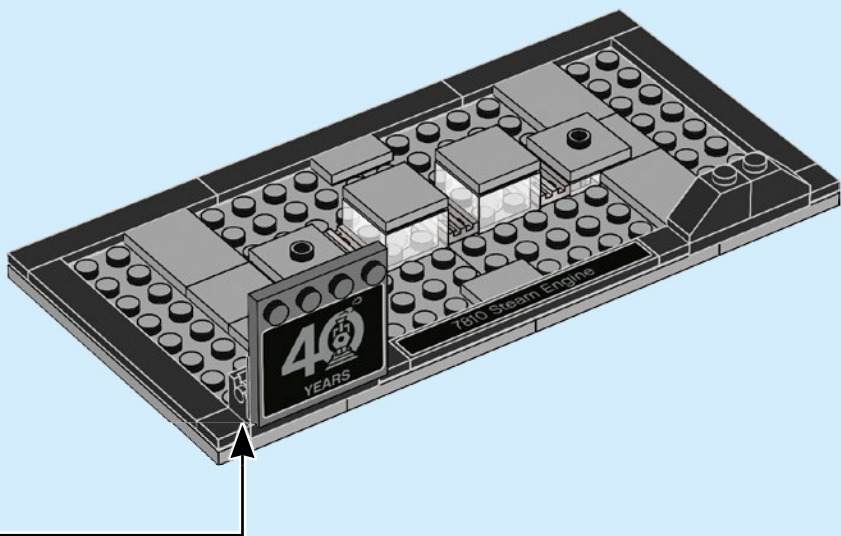

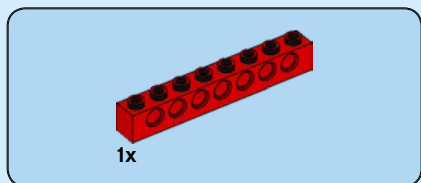
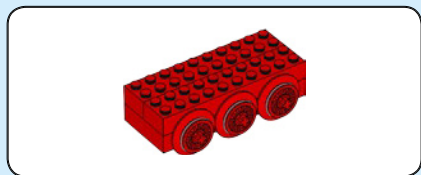

**12**

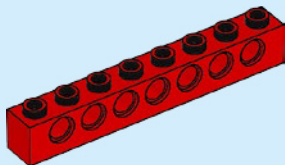

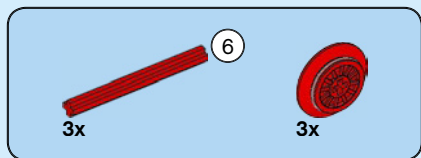

**13**

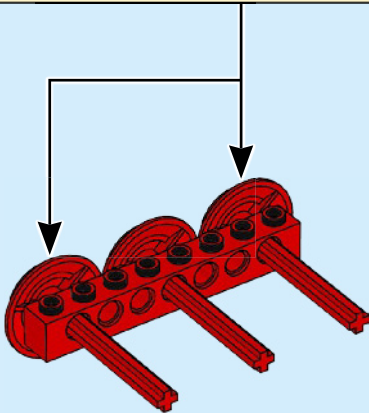
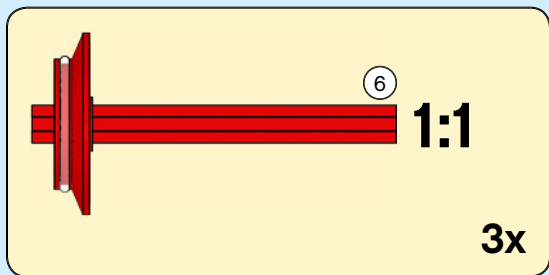





14

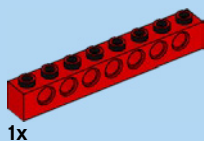
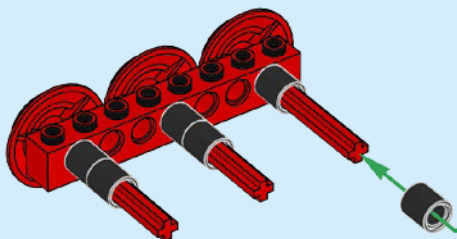

15

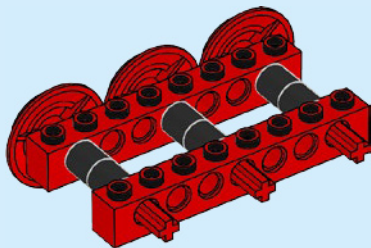



3x

16

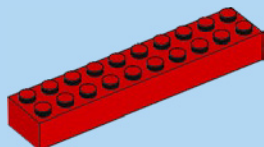
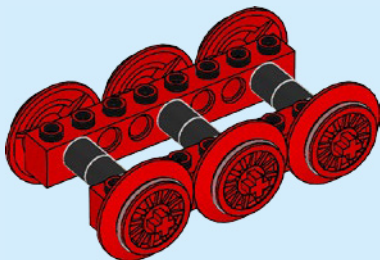

2x

17

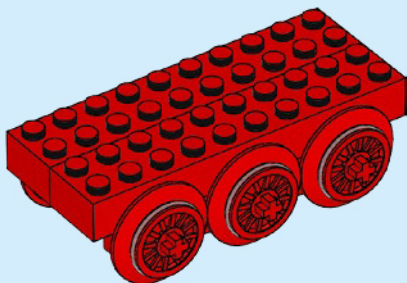

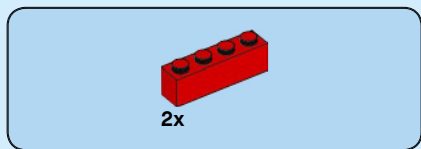

18

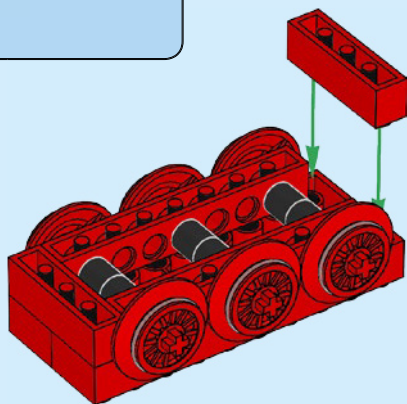

19

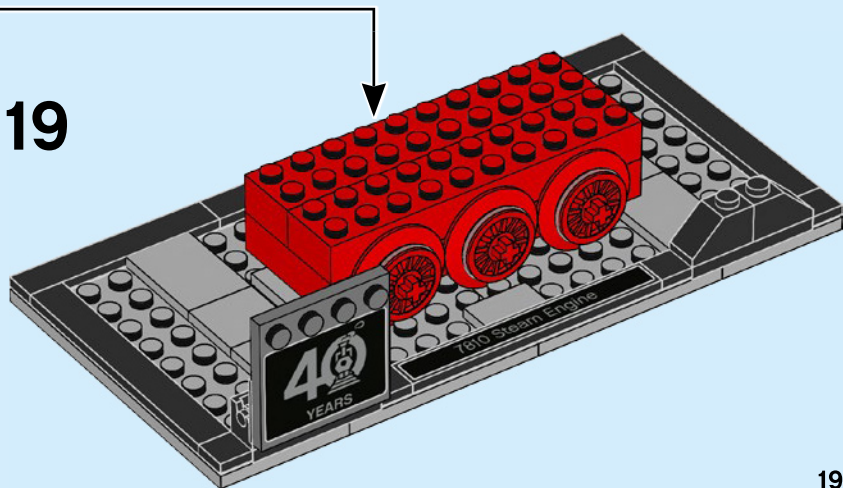

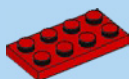
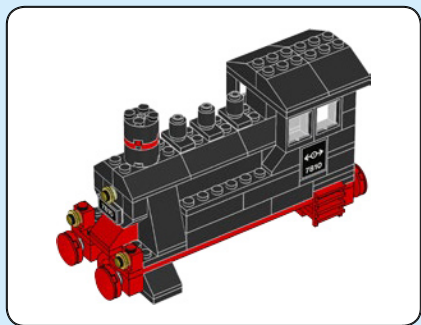

1x

20

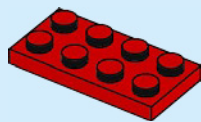

1x

21

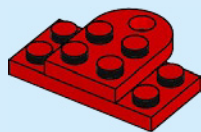



2x

# 22

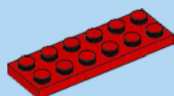
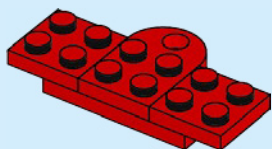

2x



1x

# 23

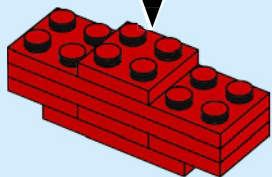
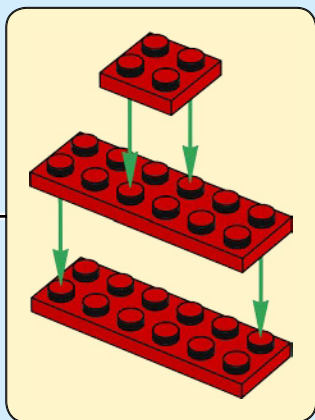

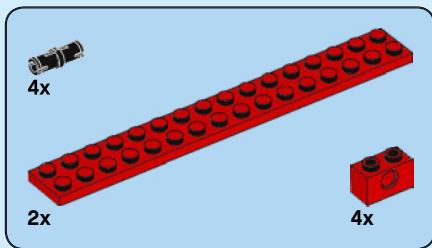
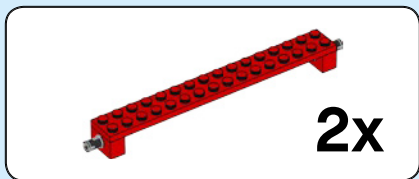

24

1

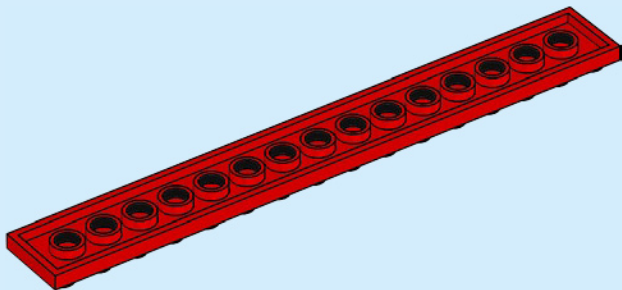

2

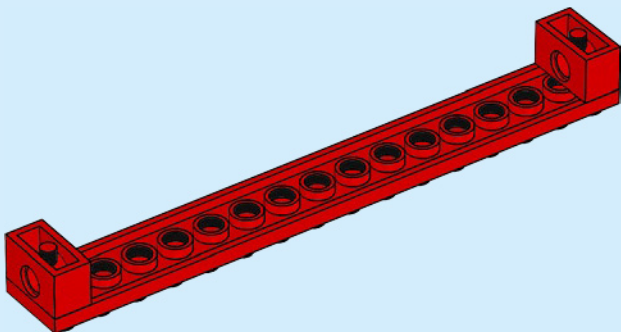

3

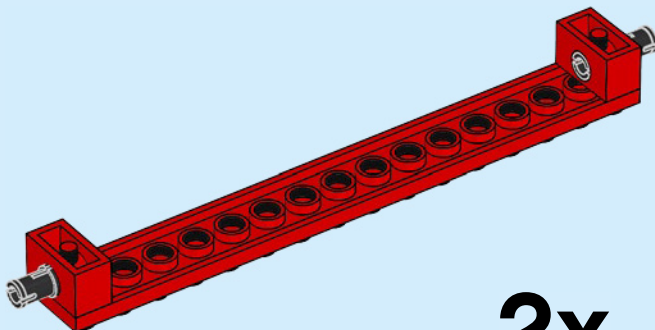

2x

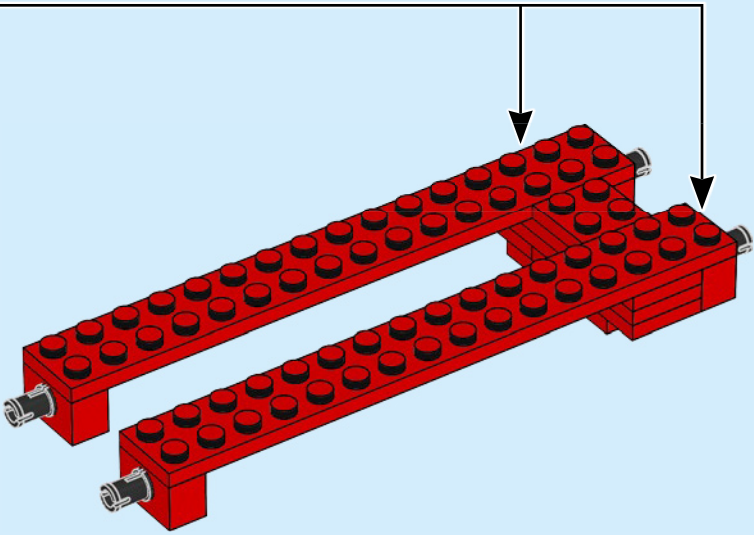



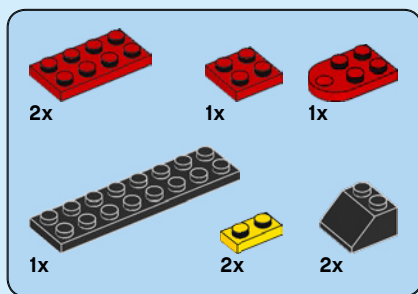

# 25

## 1

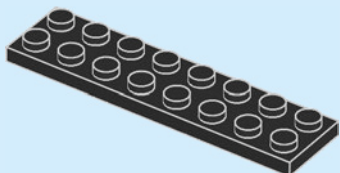

## 2

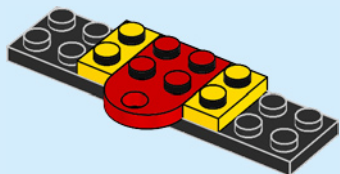

## 3

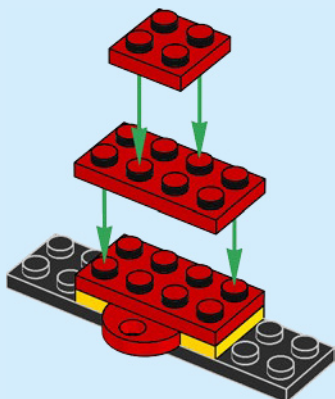

## 4

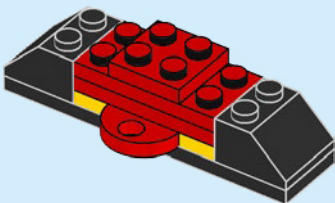

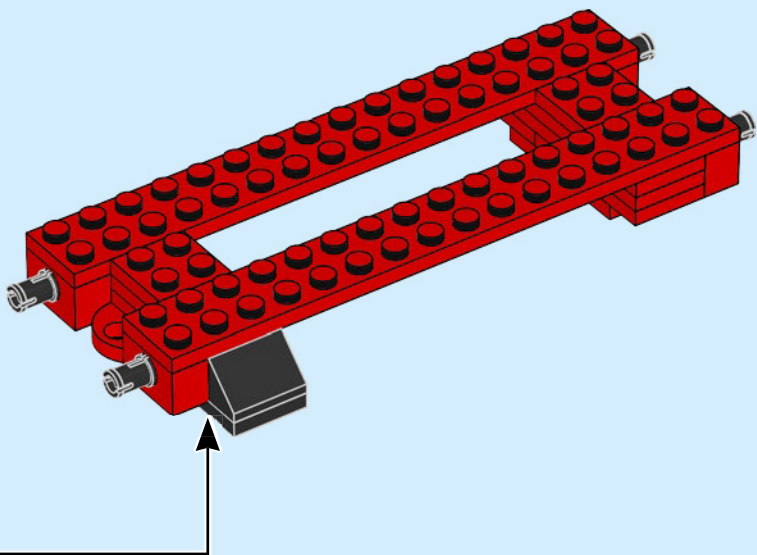



4x



4x



4x

# 26

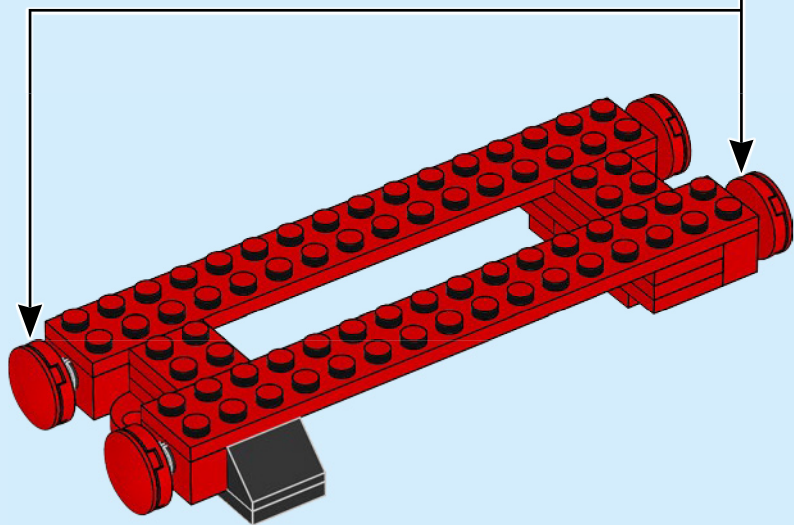

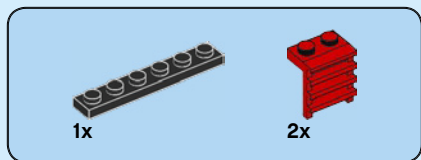

27

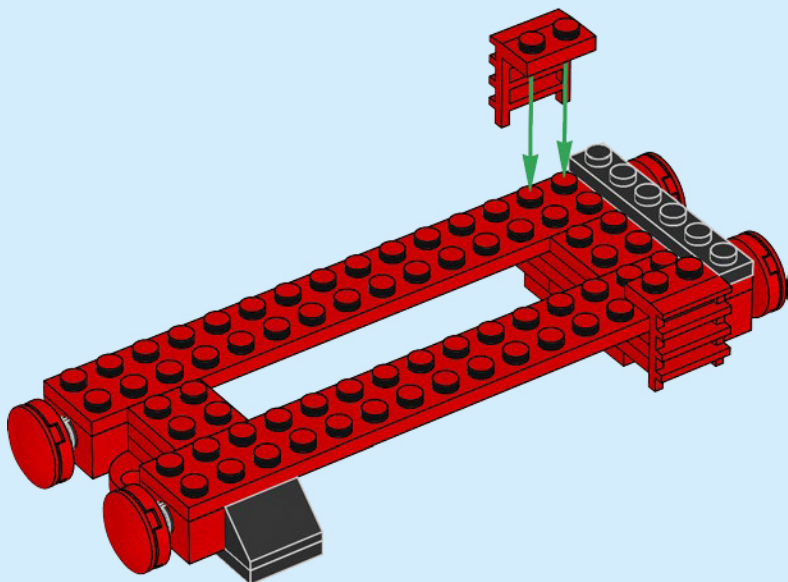

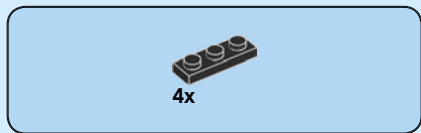

28

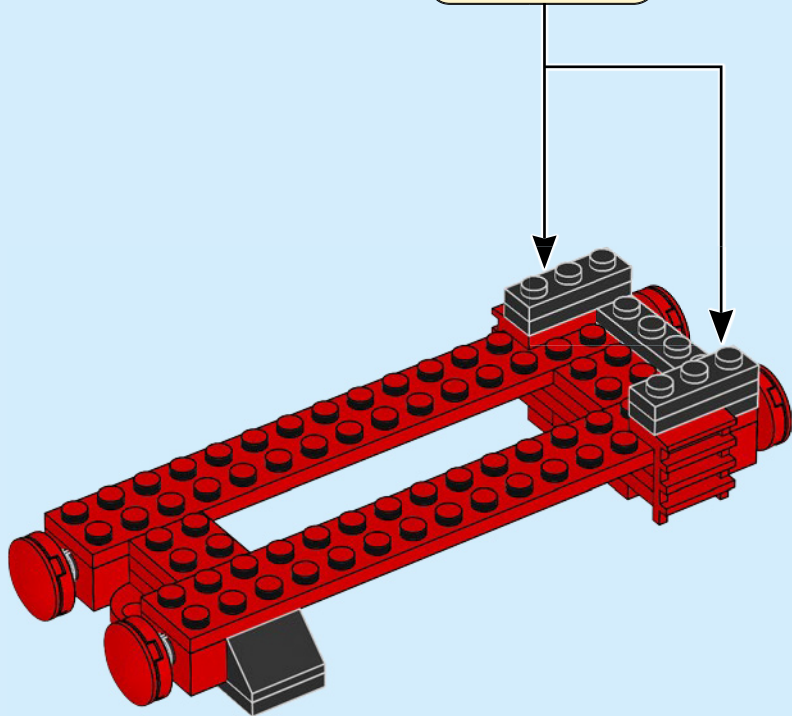
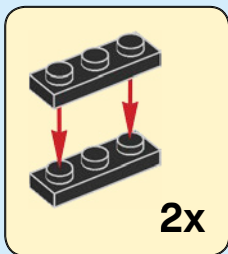

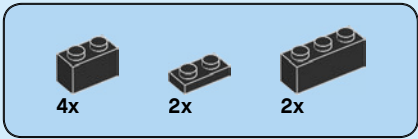

# 29

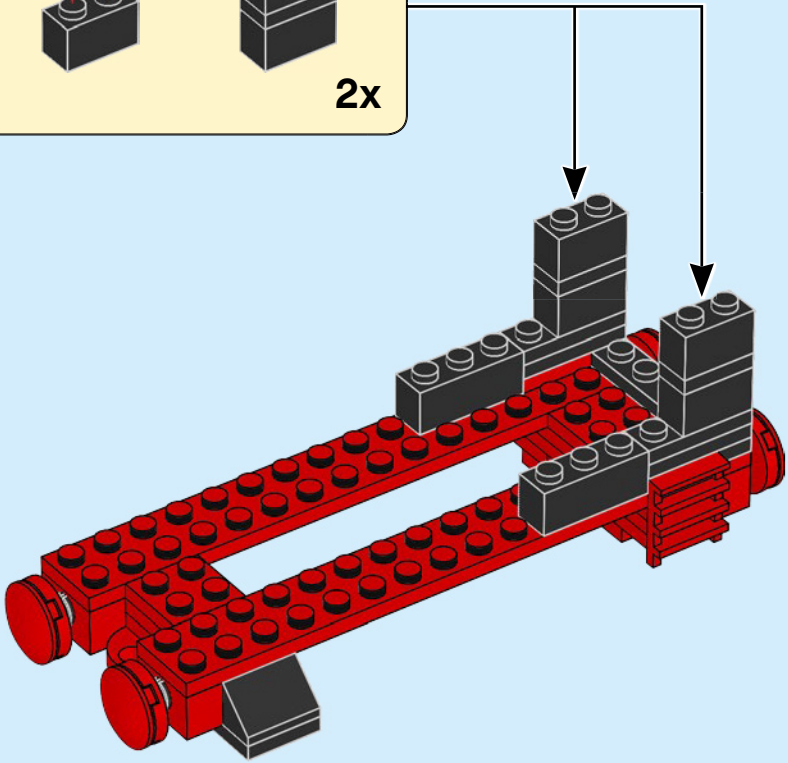
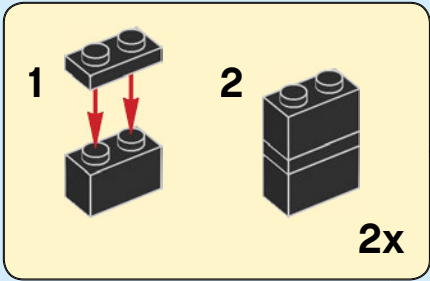

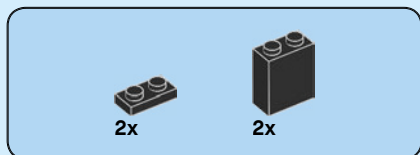

# 30

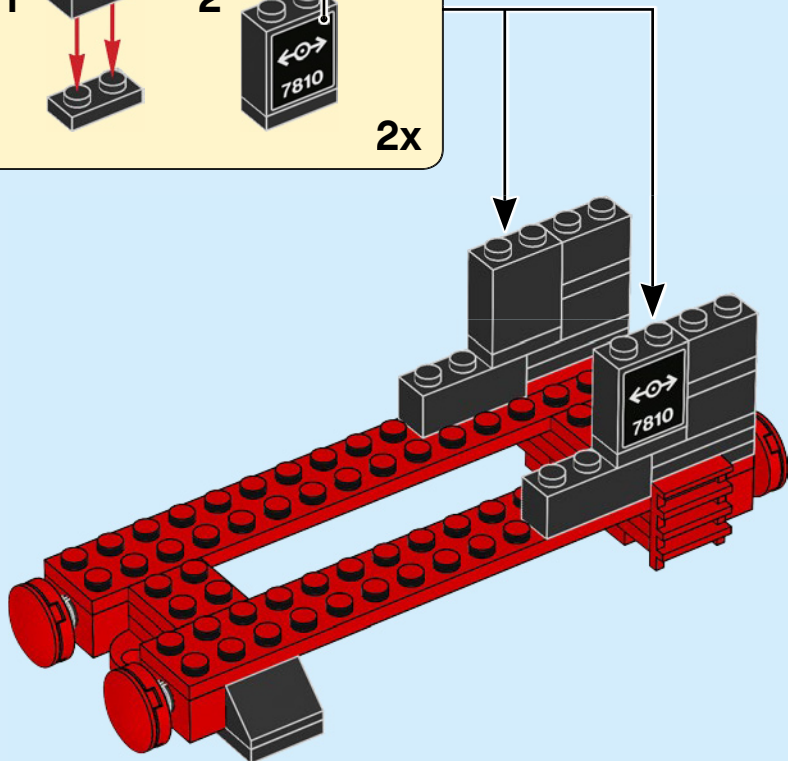
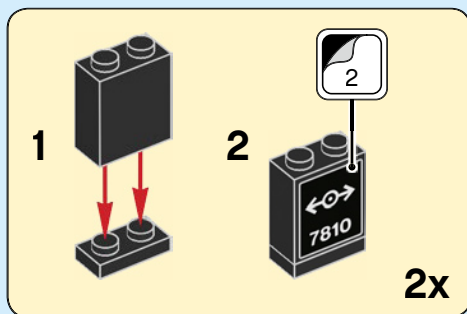

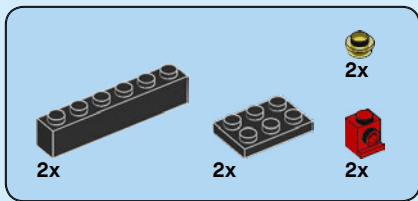

# 31

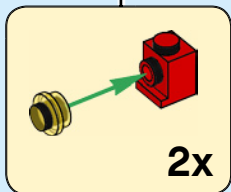
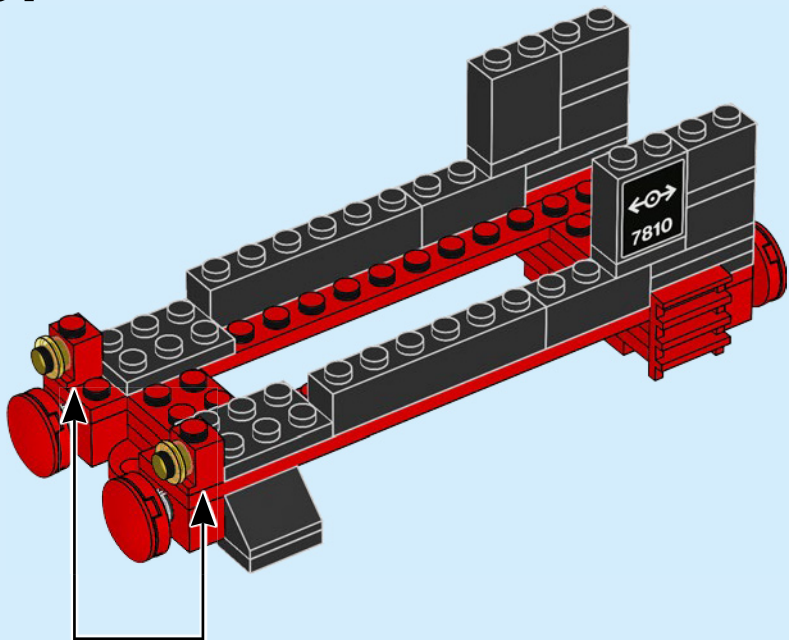



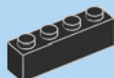

4x

32

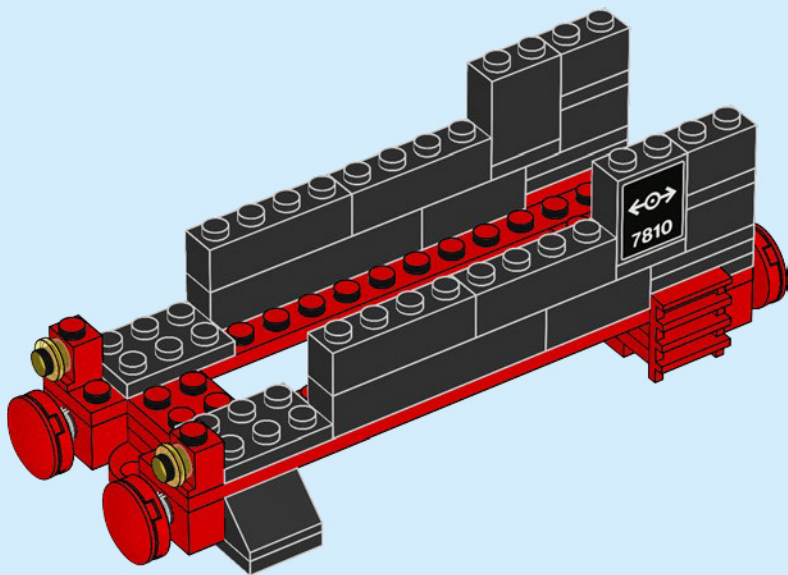

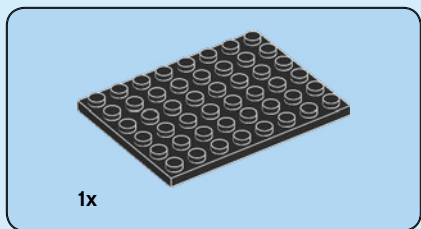

33

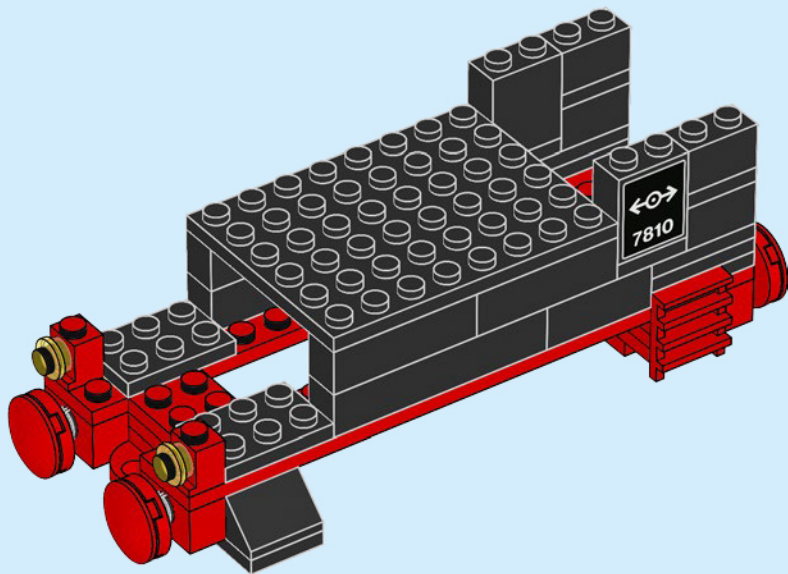



2x

# 34

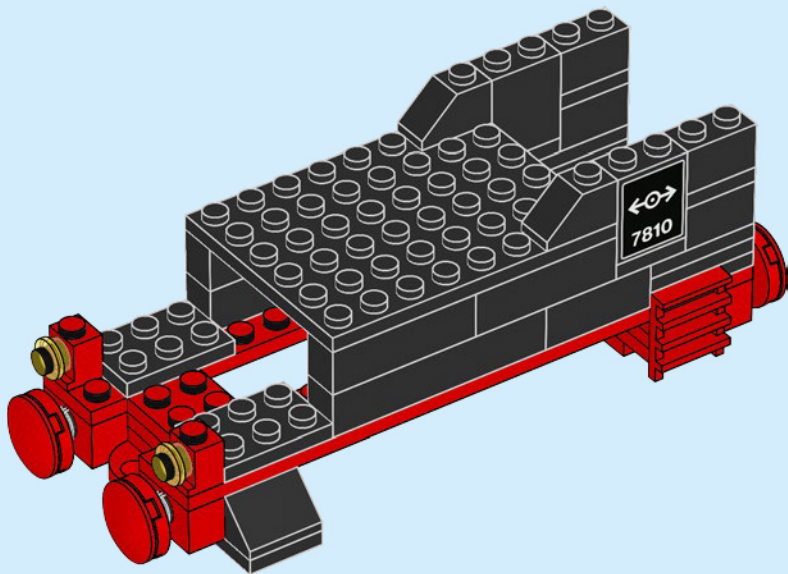

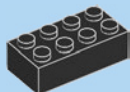

1x

# 35

1

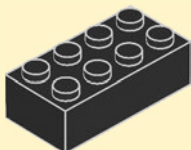

2

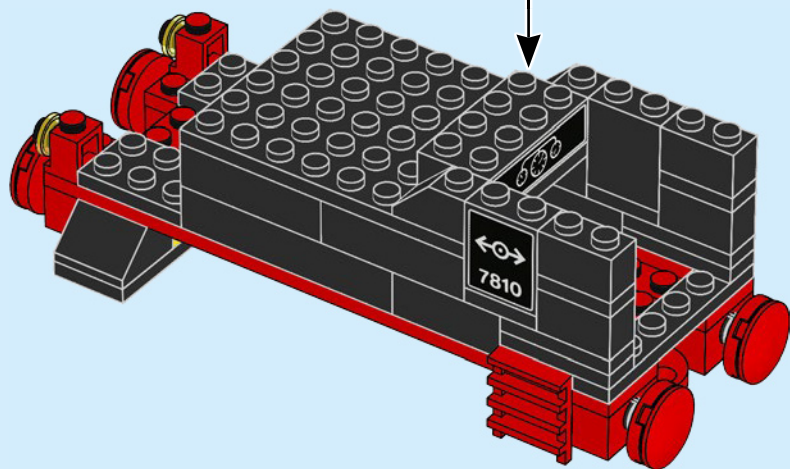
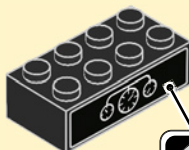

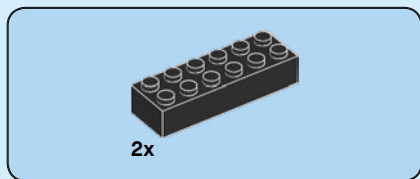

36

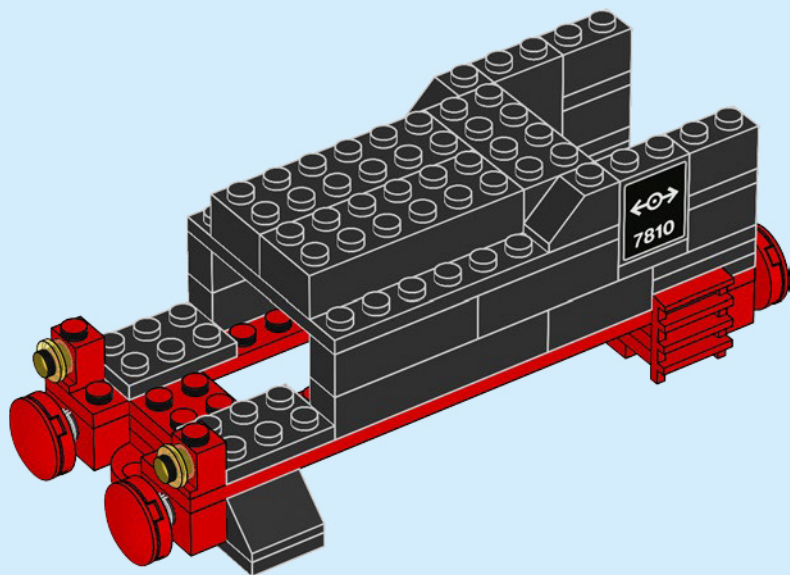



2x

37

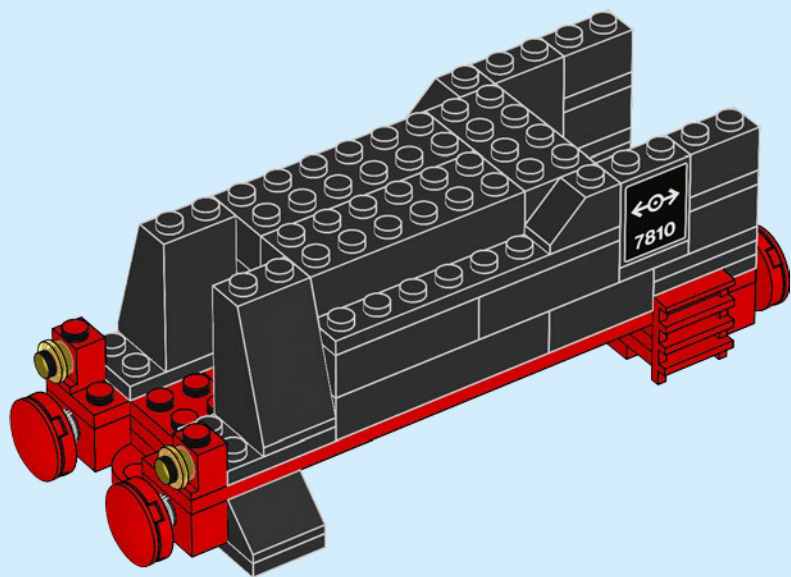

38

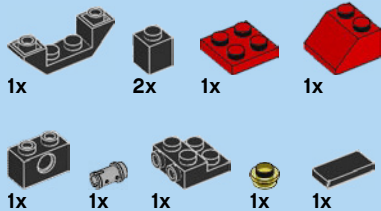

# 38

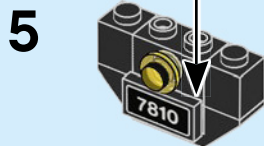
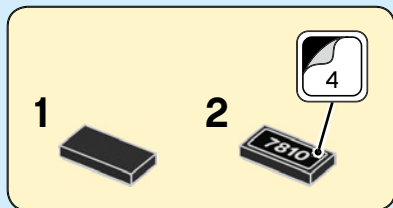
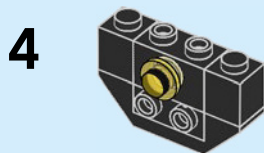
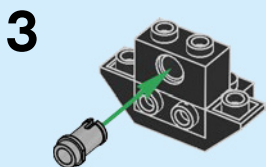
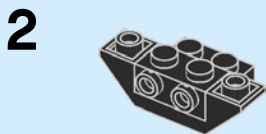
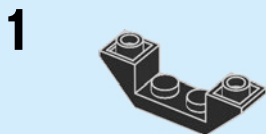

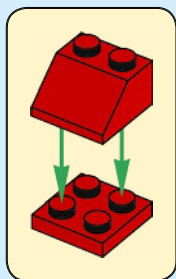

6

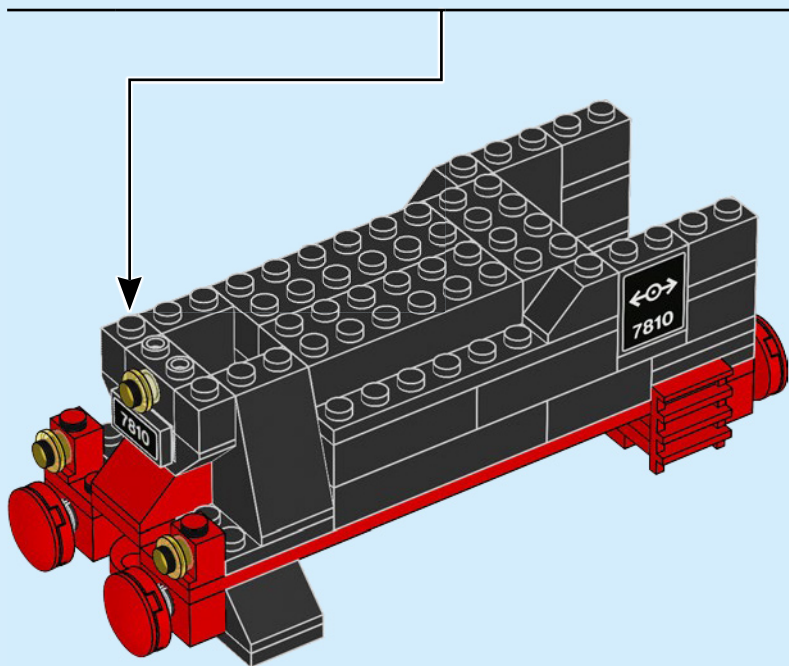
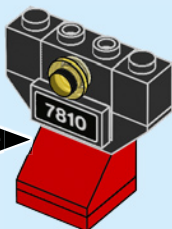



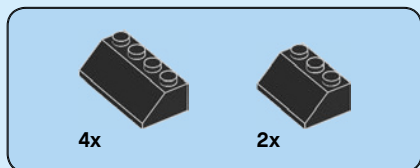

# 39

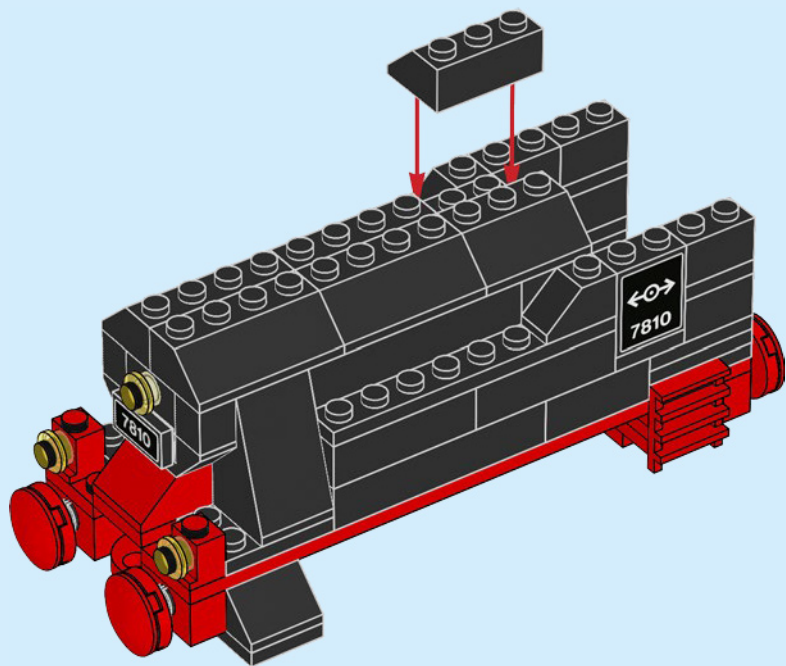



1x



3x

# 40

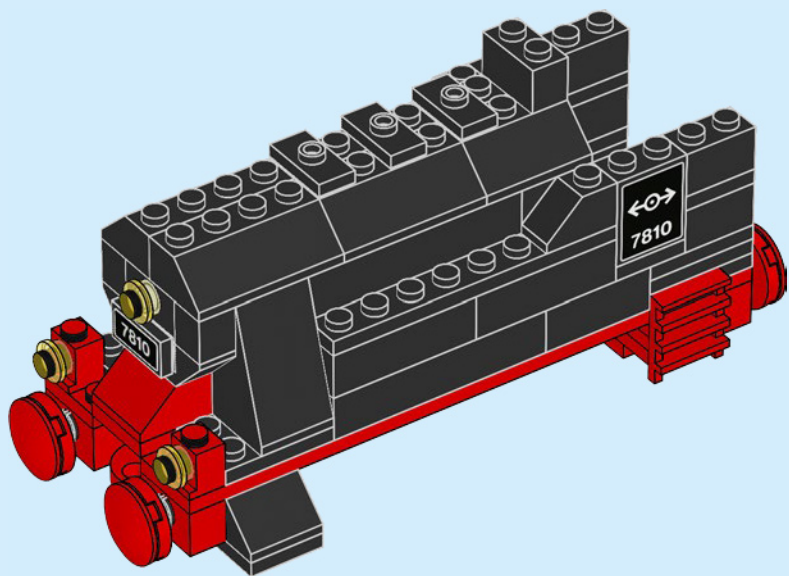

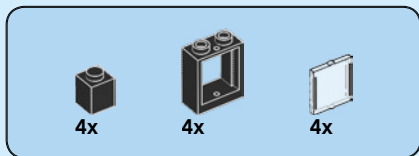

41

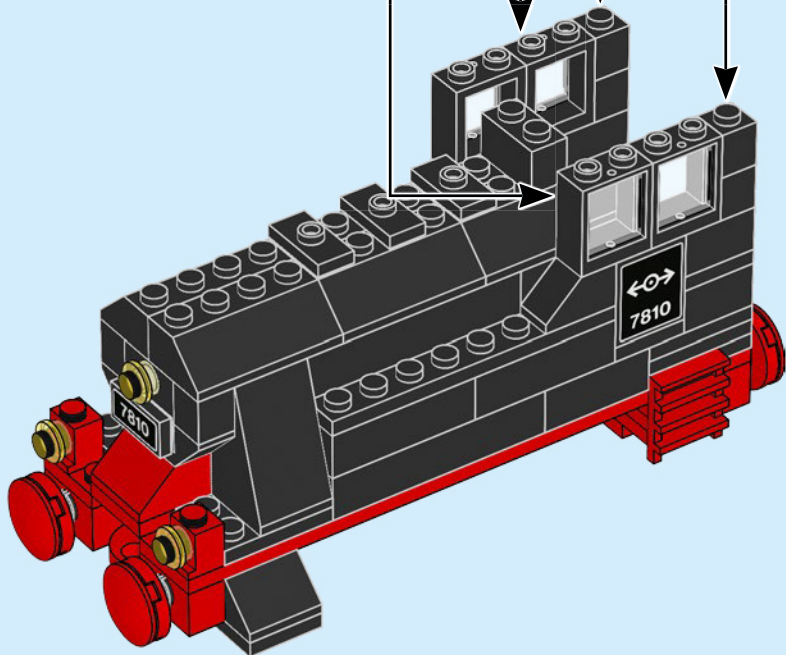
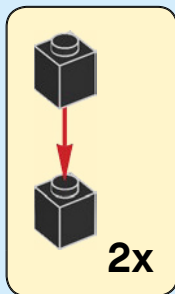
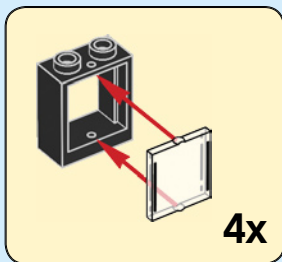

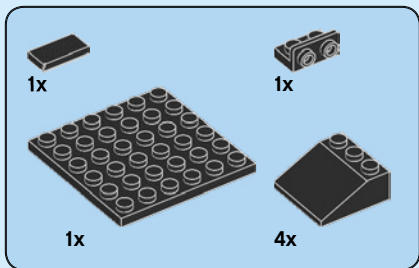

42

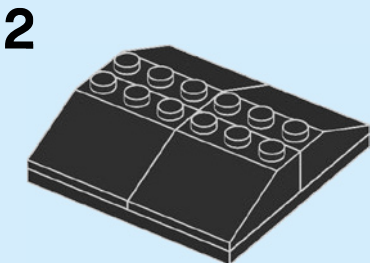
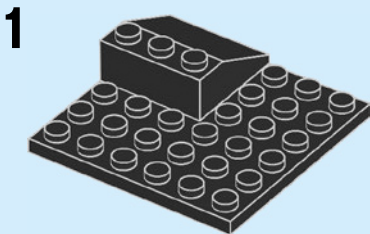

44

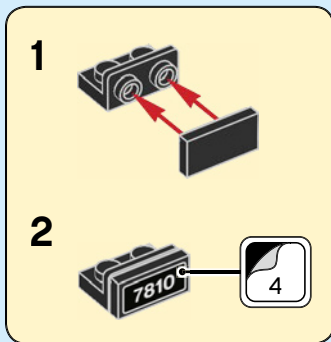

3

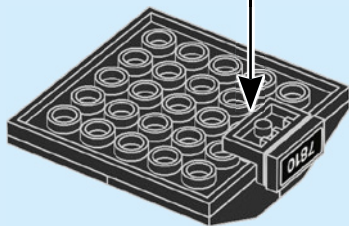

4

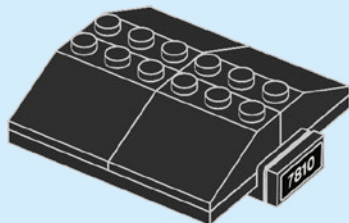

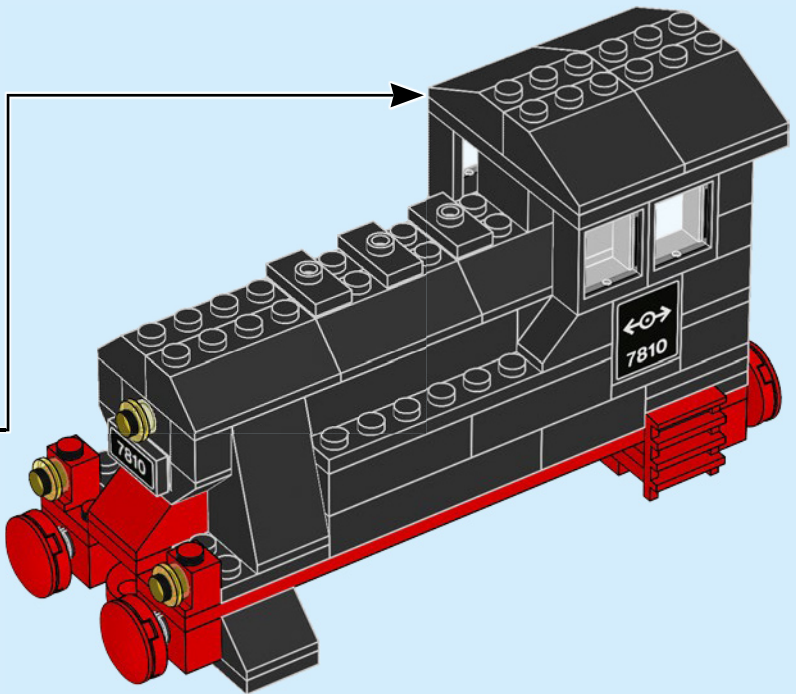



3x

43

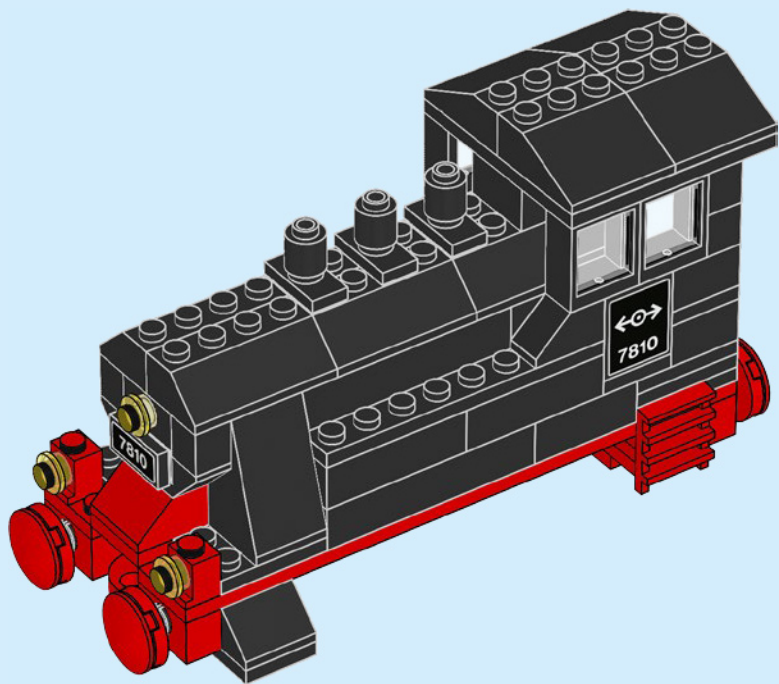

46



1x



2x

# 44

1



2

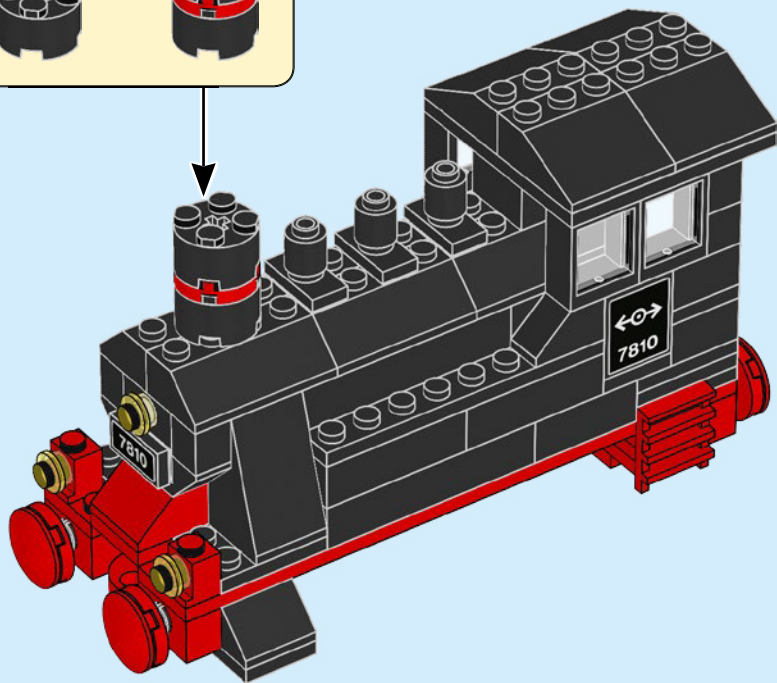

45

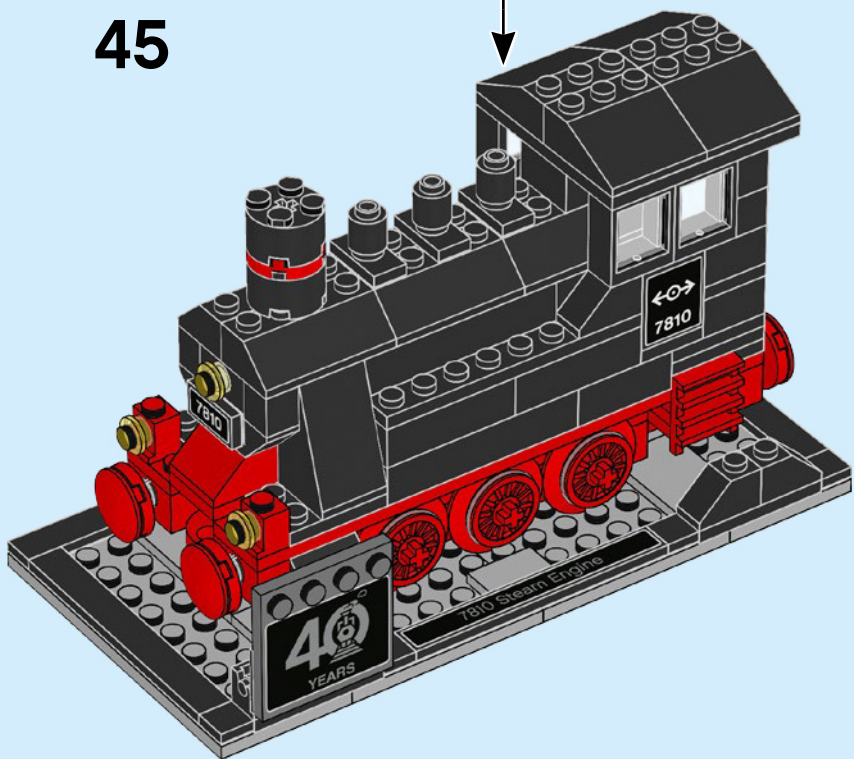



46

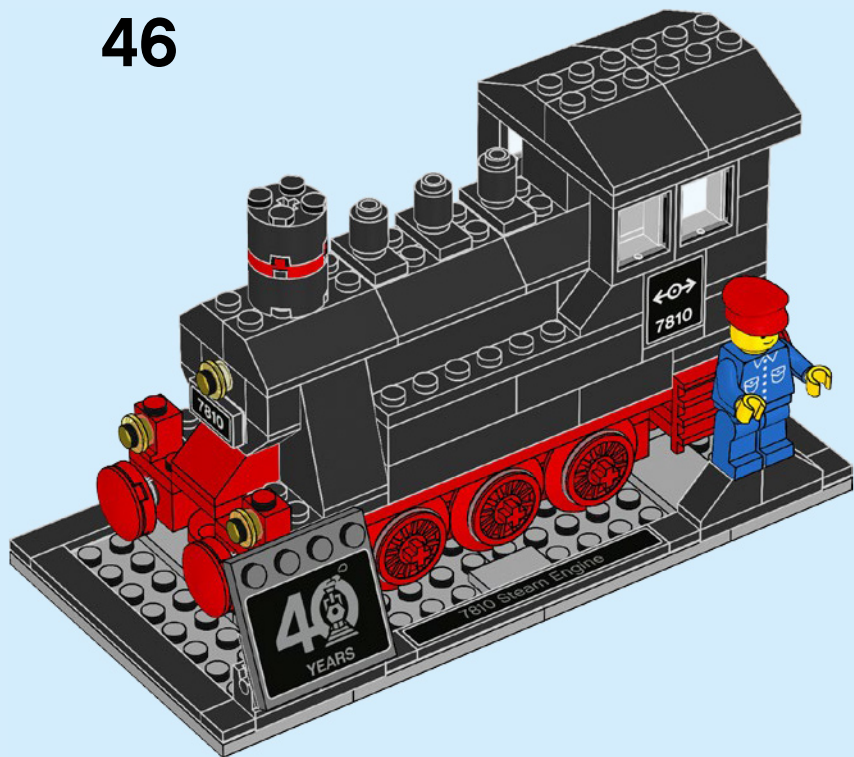

  
2x  
407021

  
1x  
6292414

  
4x  
4278275

  
1x  
403221

  
4x  
6102138

  
4x  
370021

  
2x  
6285246

  
5x  
302221

  
1x  
303921

  
2x  
4188189

  
2x  
301021

  
3x  
302021

  
3x  
6130002

**50**

  
2x  
379521

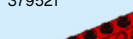
  
2x  
370221

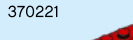
  
2x  
4617857

  
2x  
428221

  
6x  
6148299

  
2x  
302324

  
1x  
9336

  
1x  
6292799

  
1x  
9341

  
3x  
6240216

  
6x  
6121485

  
4x  
307026

  
6x  
300526

  
2x  
614326

  
4x  
4121715

  
4x  
4121966

  
3x  
6092585

  
5x  
300426

  
4x  
4521439

  
2x  
4618852

  
1x  
370026

  
2x  
306926

  
2x  
393726

  
4x  
302326

  
1x  
6020193

  
2x  
4124096

  
2x  
303926

  
2x  
6007896

  
1x  
6052126

  
4x  
362326

  
2x  
362226

  
2x  
303826

  
2x  
302126

  
2x  
371026

  
1x  
6267482

  
3x  
306226



4x  
301026



4x  
303726



4x  
416126



1x  
300126

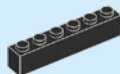

2x  
300926



1x  
366626



2x  
663626

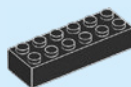

2x  
418144



4x  
416226

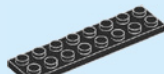

1x  
303426

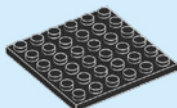

1x  
395826

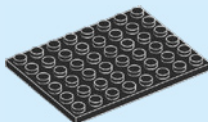

1x  
303626

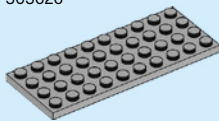

2x  
4211402

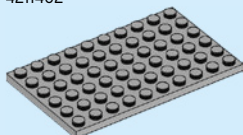

2x  
4211405



1x  
4211483



3x  
4211414



2x  
6126082



3x  
4211413



4x  
6171894

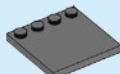

1x  
4509911



4x  
6254552



4x  
6240204



2x  
6239418



3x  
4619636



Customer Service

Kundenservice

Service Consommateurs

Servicio Al Consumidor

LEGO.com/service or dial



: 00800 5346 5555

: 1-800-422-5346

# WIN

GO TO [WWW.LEGO.COM/PRODUCTFEEDBACK](http://WWW.LEGO.COM/PRODUCTFEEDBACK)  
AND GIVE US YOUR SHORT **FEEDBACK**  
ABOUT THIS LEGO® SET FOR A CHANCE  
TO WIN A COOL LEGO PRIZE.

Terms & Conditions apply



## LEGO.com/productfeedback

### GEWINNE

Erzähle uns auf  
[www.LEGO.com/productfeedback](http://www.LEGO.com/productfeedback)

etwas über die Erfahrungen, die du mit  
diesem LEGO® Set gemacht hast, und  
sichere dir die Chance auf einen coolen  
LEGO Preis!

Es gelten die Teilnahmebedingungen

### GAGNE

Rends-toi sur  
[www.LEGO.com/productfeedback](http://www.LEGO.com/productfeedback)

et donne-nous quelques commentaires  
sur ce produit LEGO® pour avoir une  
chance de gagner un prix LEGO !

Voir Conditions Générales

### GANA

Visita  
[www.LEGO.com/productfeedback](http://www.LEGO.com/productfeedback)

y envíanos tu opinión acerca de este  
set LEGO®. ¡Participarás en el sorteo  
de un premio LEGO!

Términos y Condiciones aplicables

### 获取奖品

登录  
[www.LEGO.com/productfeedback](http://www.LEGO.com/productfeedback)

给出关于此乐高®套装的简短反馈，  
就有机会获得炫酷乐高奖品

《条款及条件》适用

### 경품 당첨 기회

[www.LEGO.com/productfeedback](http://www.LEGO.com/productfeedback)

페이지로 이동하여 이 레고® 세트에 대한  
간략한 피드백을 보내 주시고 멋진 레고  
경품을 탈 수 있는 기회도 잡으십시오

약관 적용

### ЗАПОЛНИ АНКЕТУ И ПОЛУЧИ ПРИЗ

Перейди по ссылке  
[www.LEGO.com/productfeedback](http://www.LEGO.com/productfeedback)

ответь всего на несколько во-  
просов об этом наборе LEGO®,  
и у тебя появится шанс выиграть за-  
мечательный приз от компании LEGO.

Применяются Условия и правила  
участия

LEGO and the LEGO logo are trademarks of the LEGO Group. ©2020 The LEGO Group.

6310611