

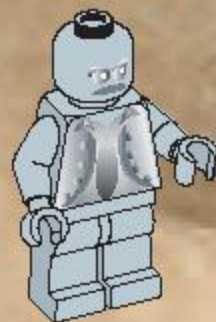

Harry Potter™

4705

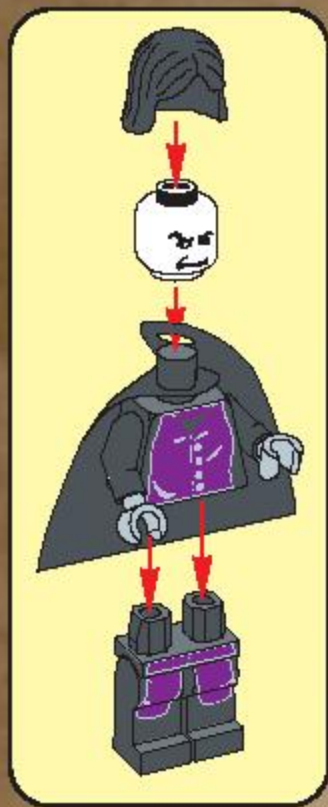



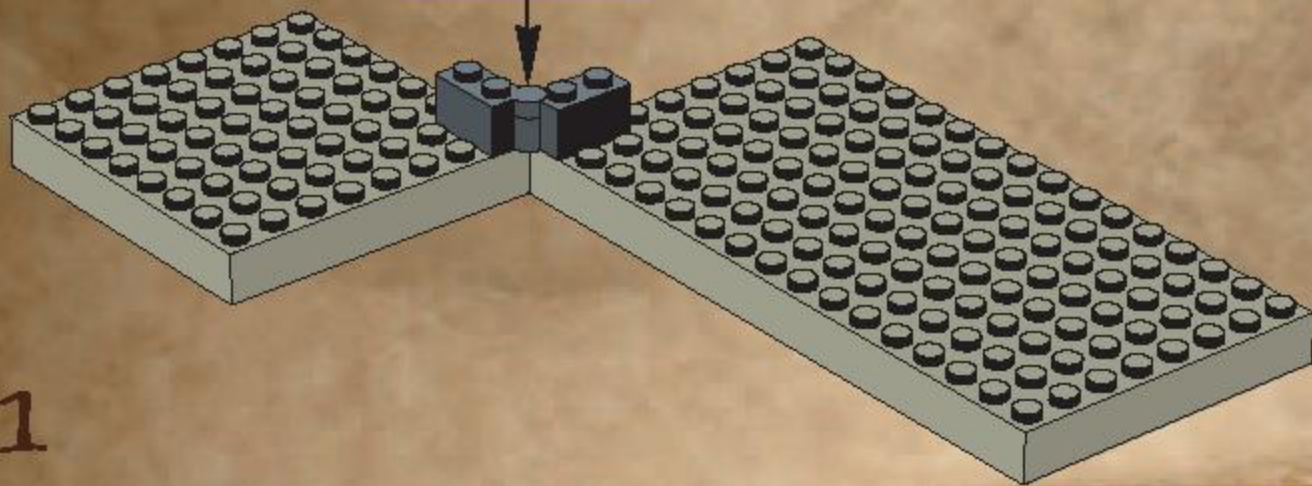
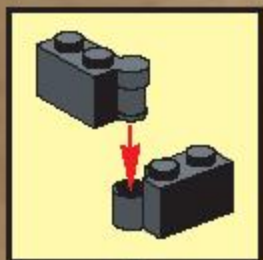

1



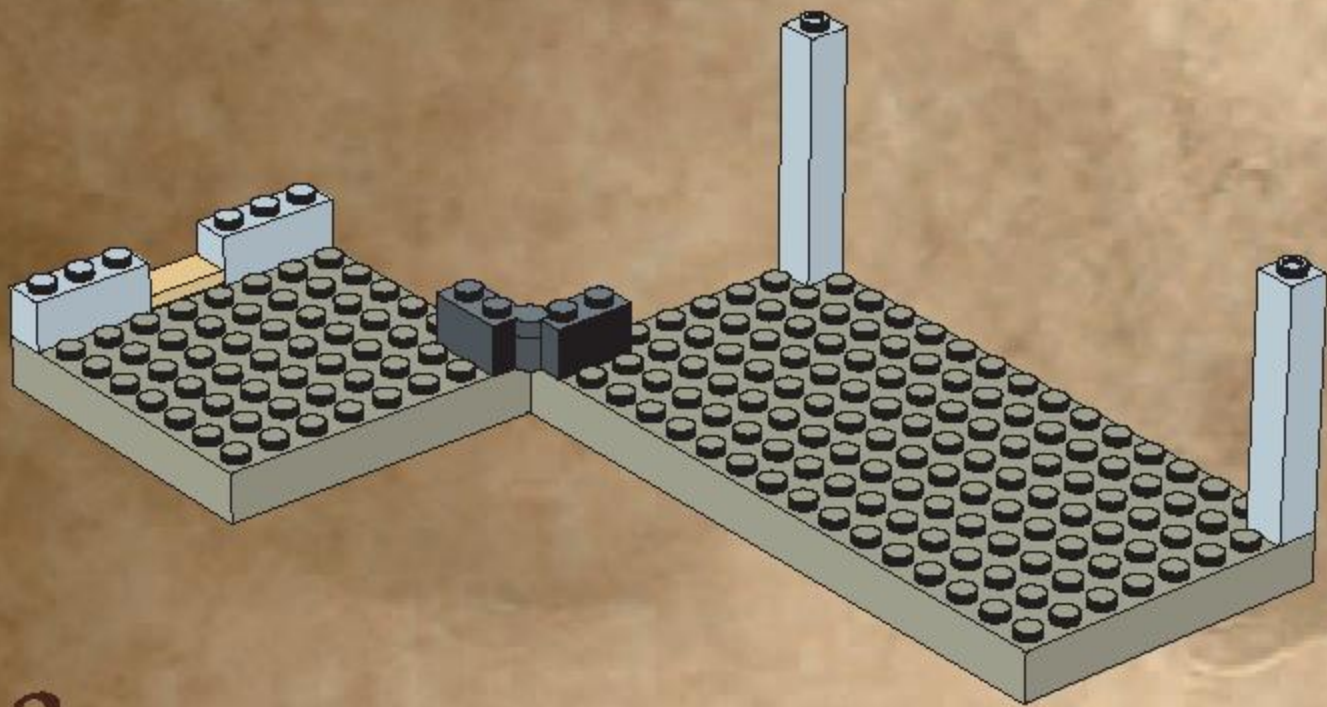

2

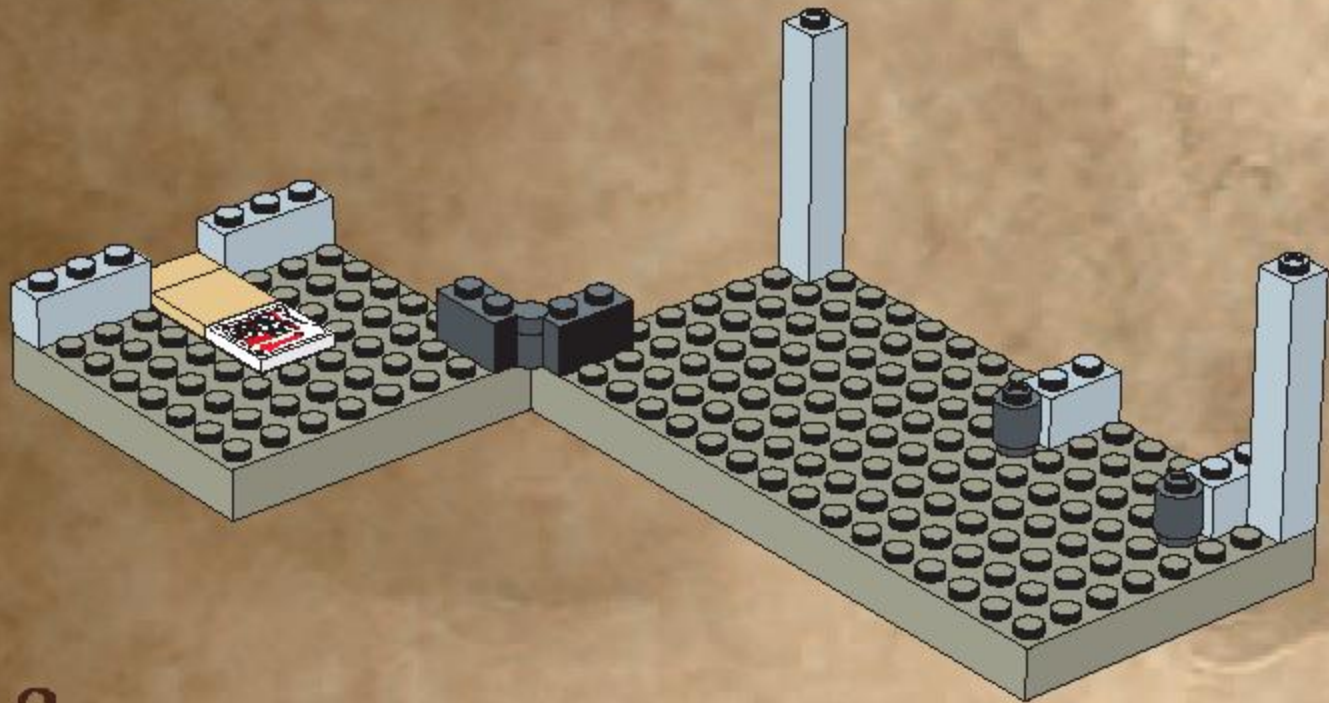

3

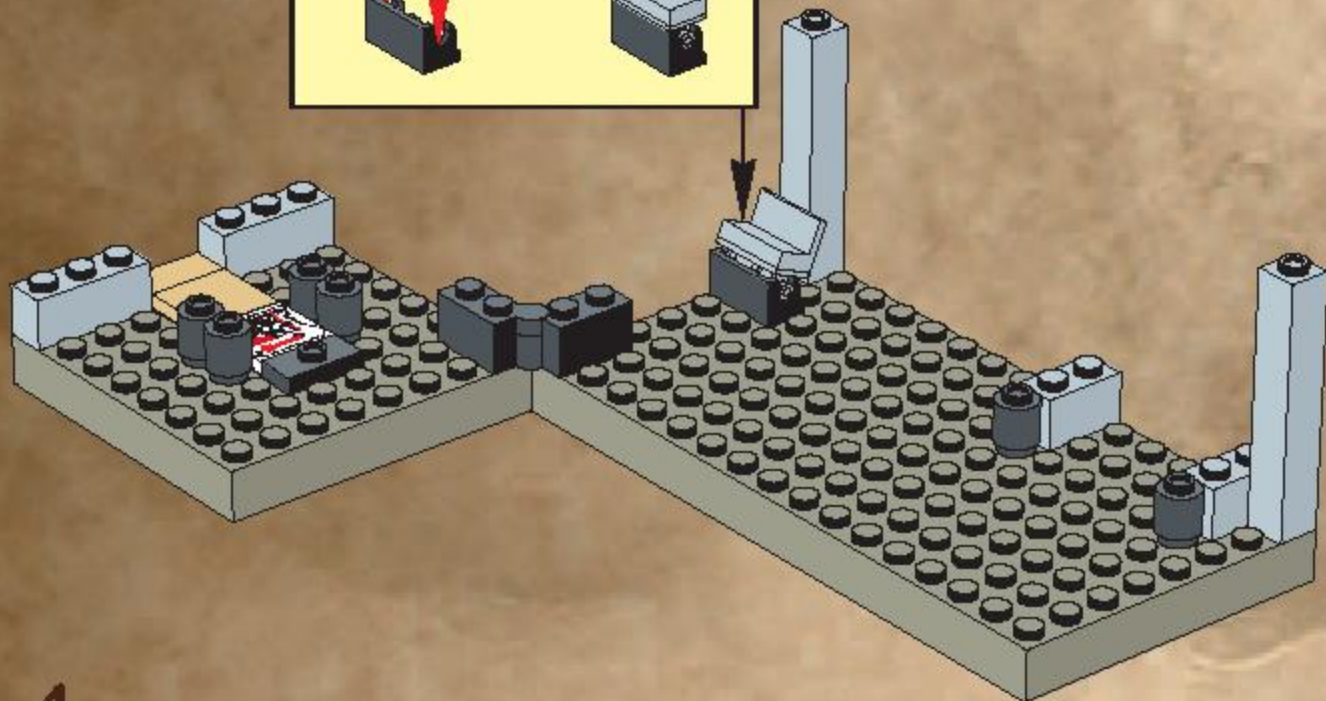
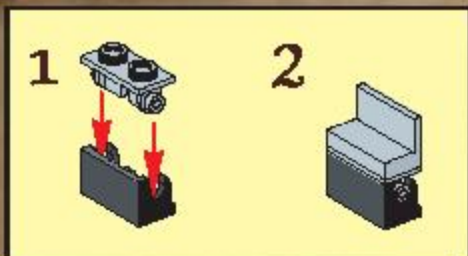

4

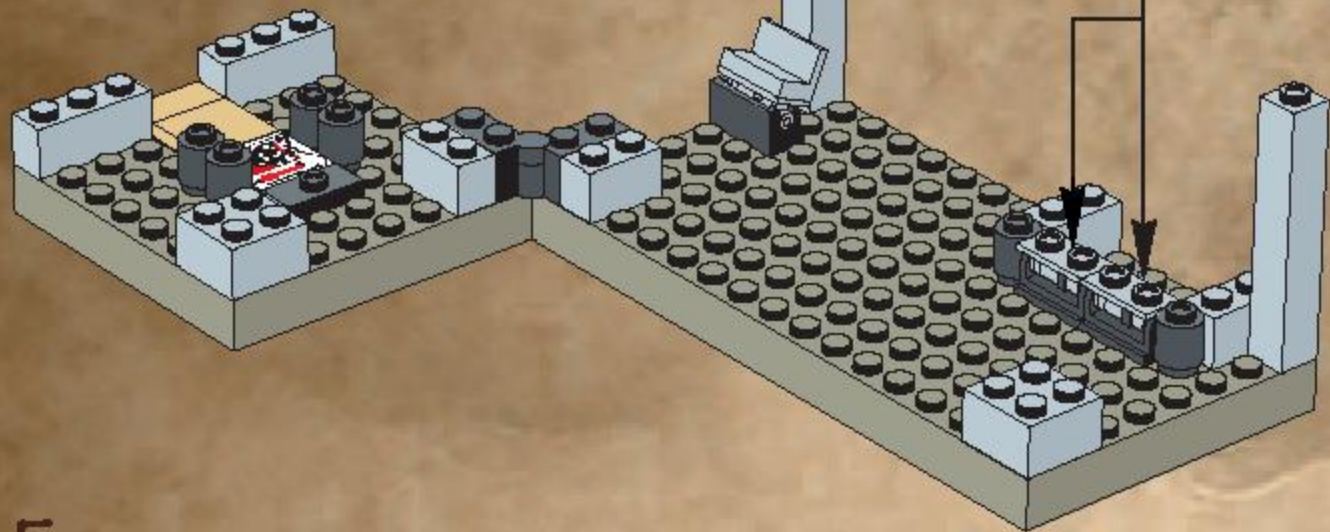

5



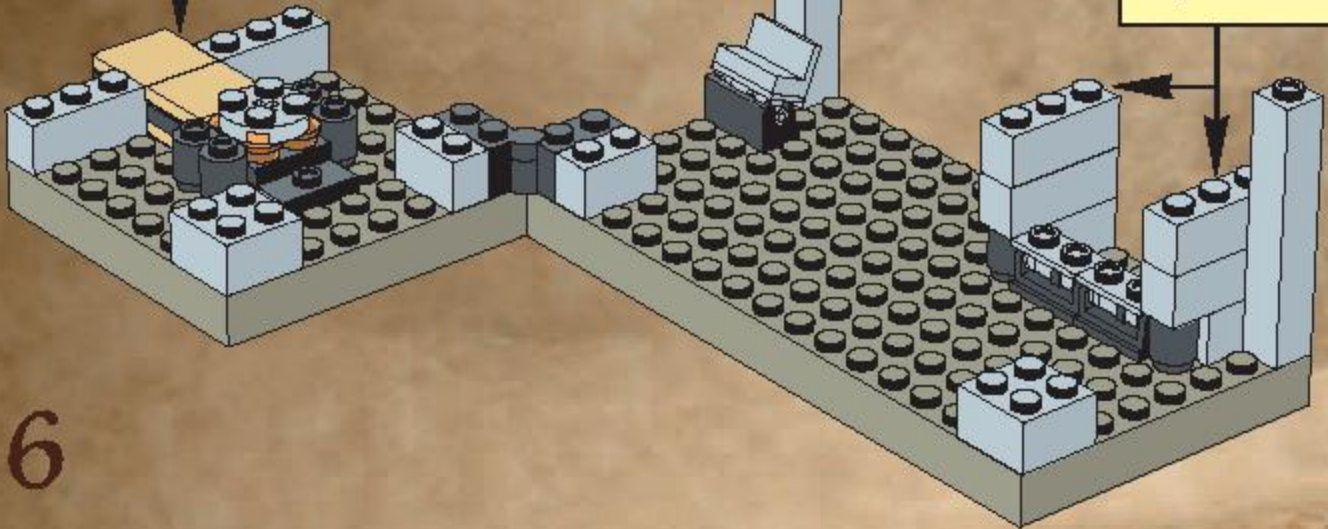
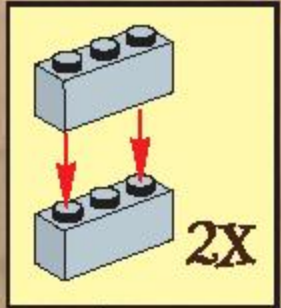

6

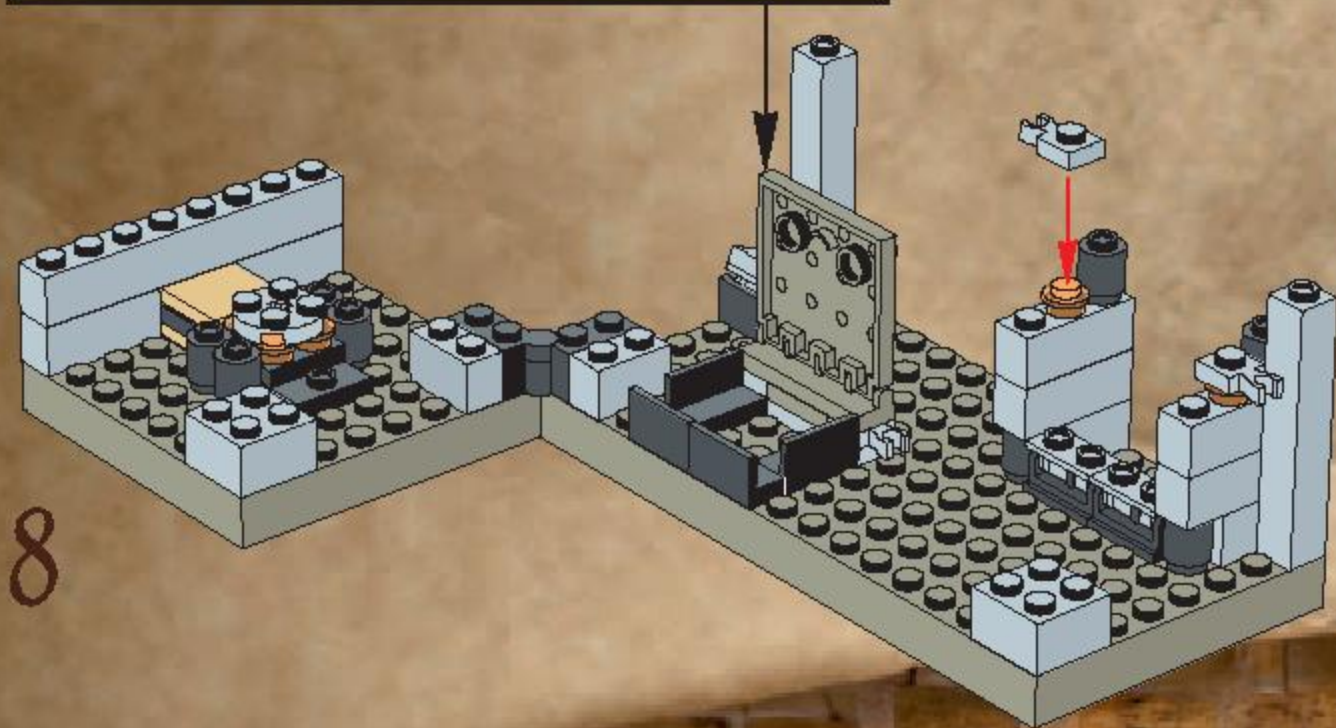
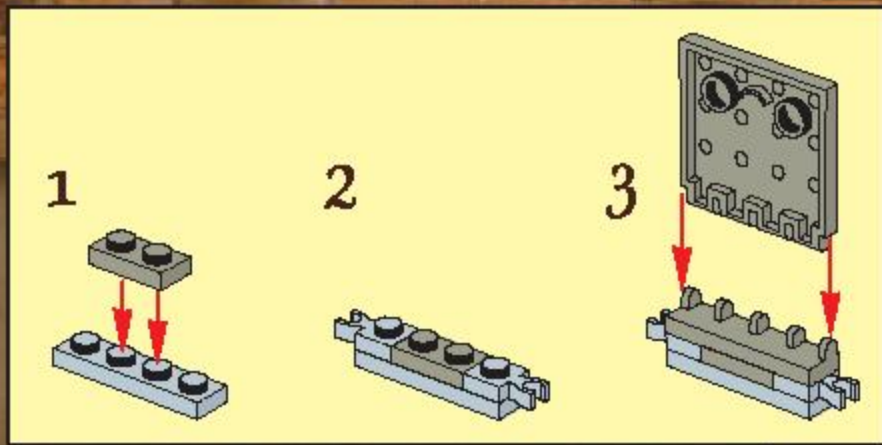

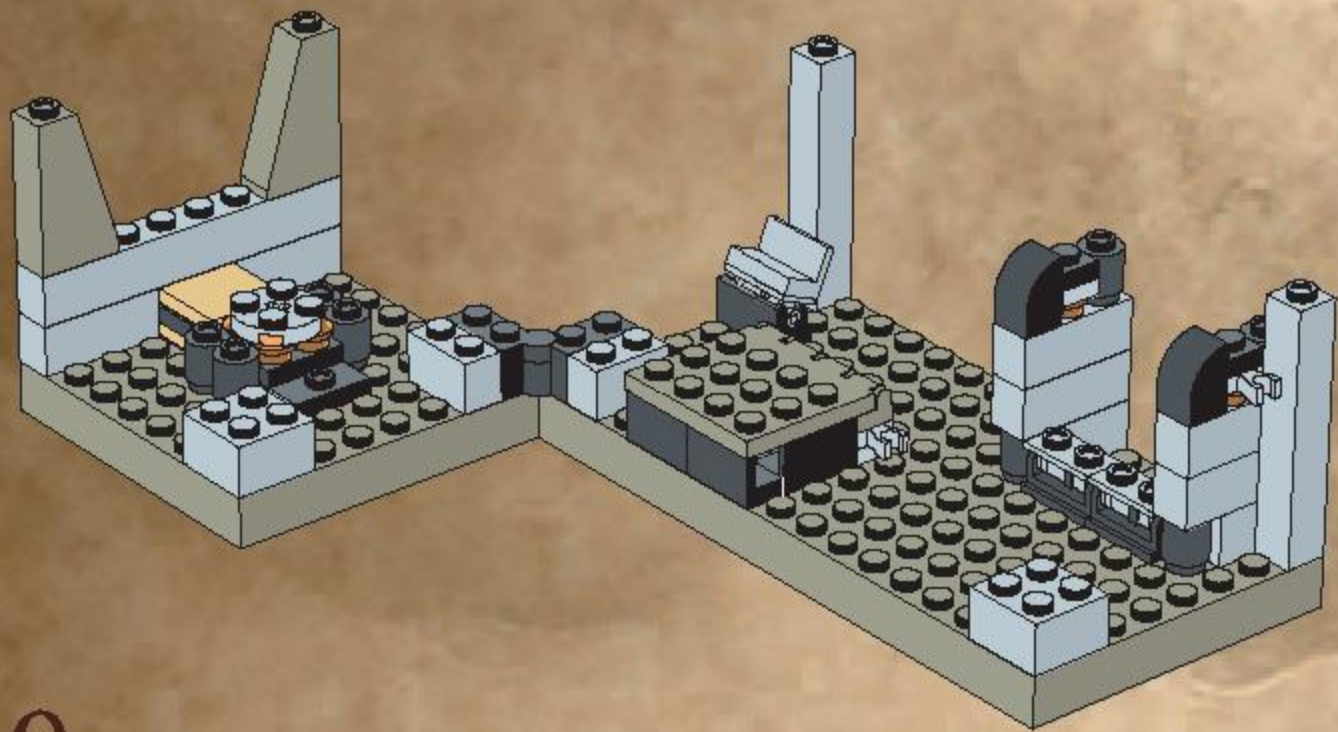

9

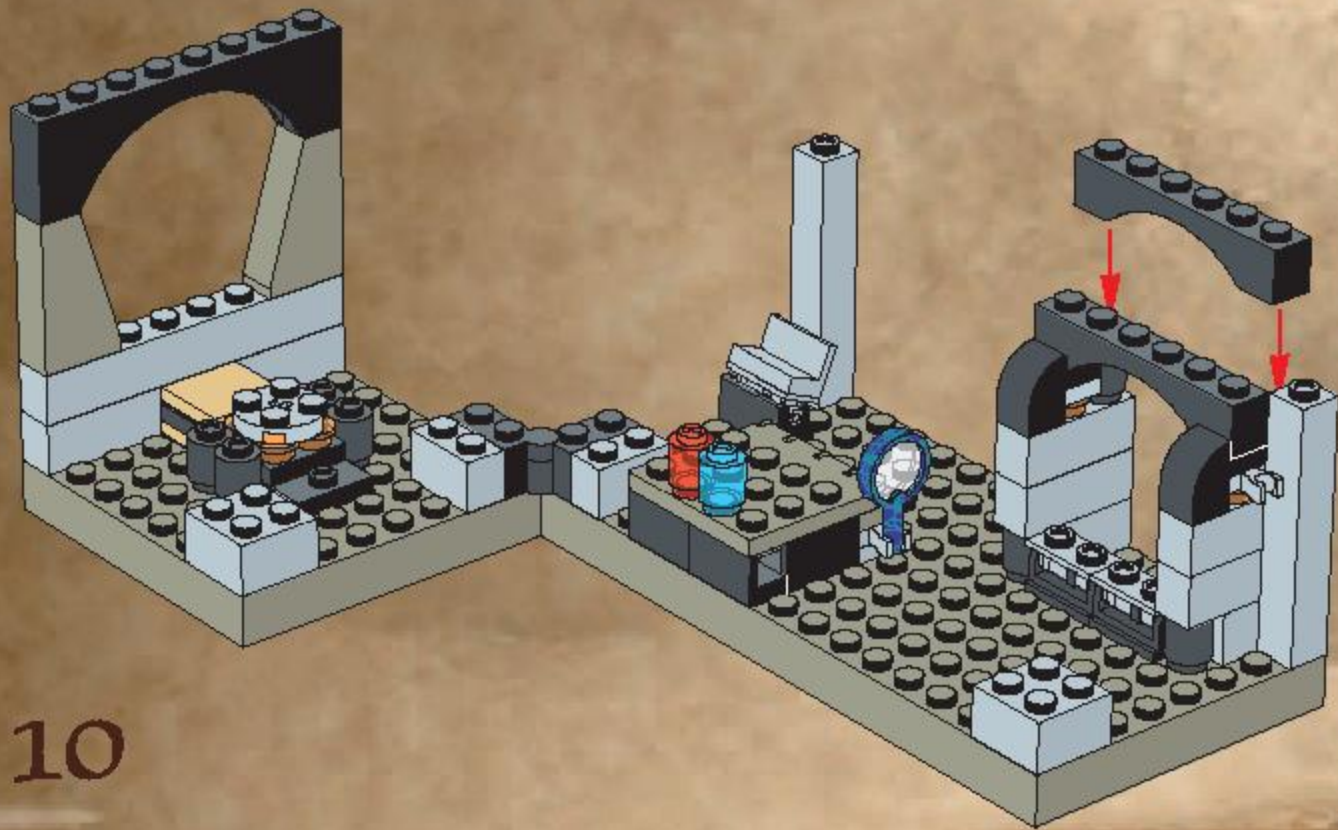

10

12



11

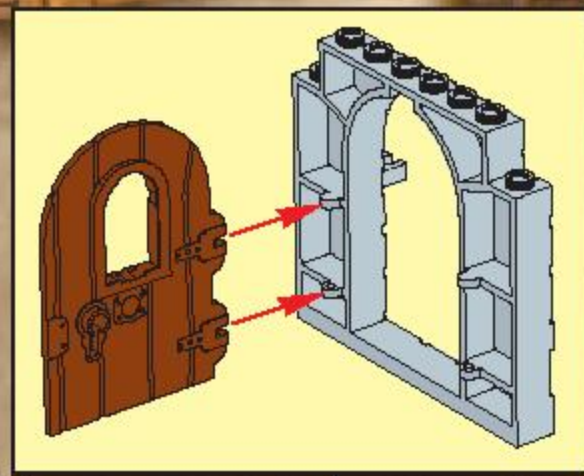

13

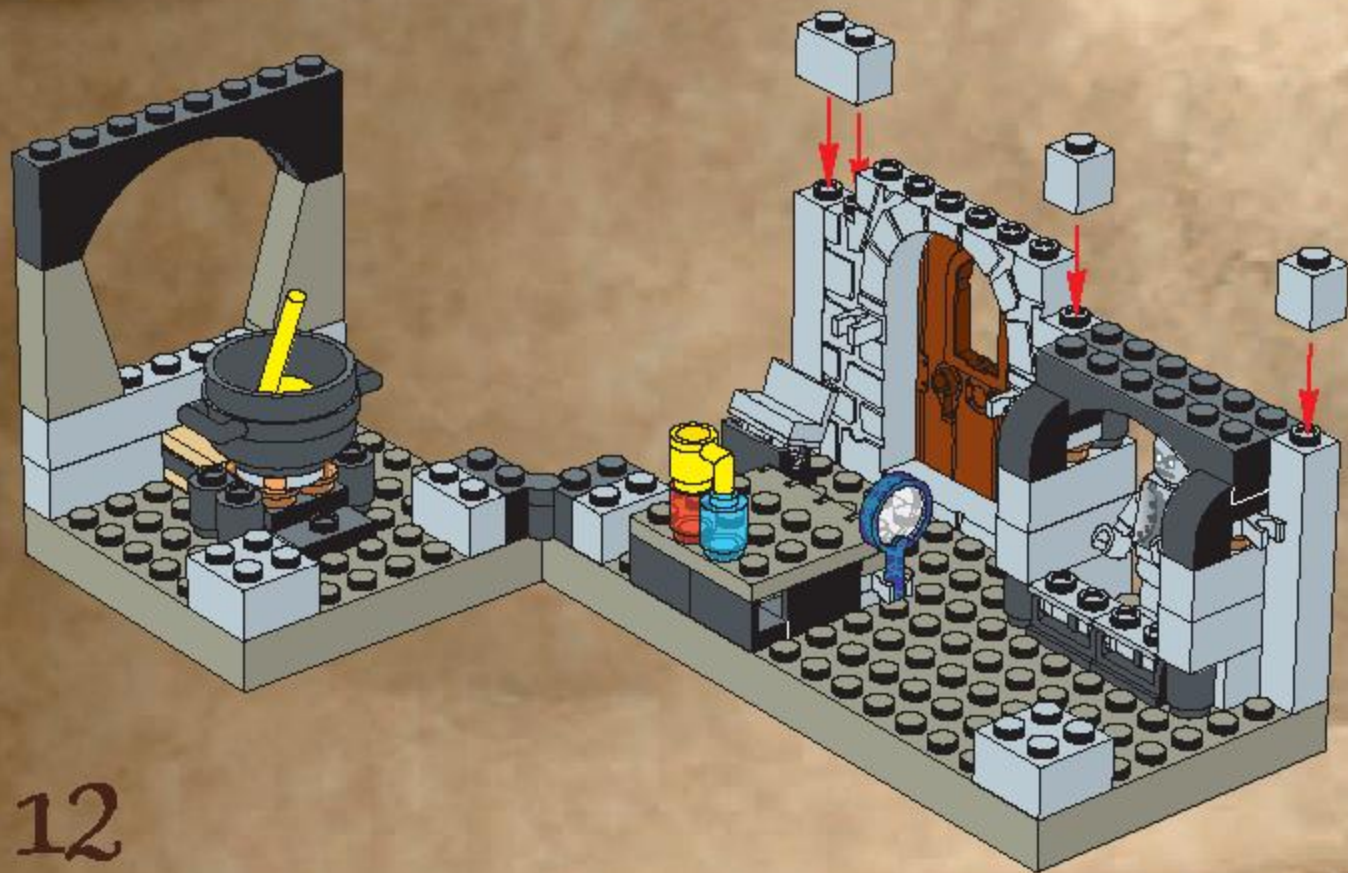

12

13



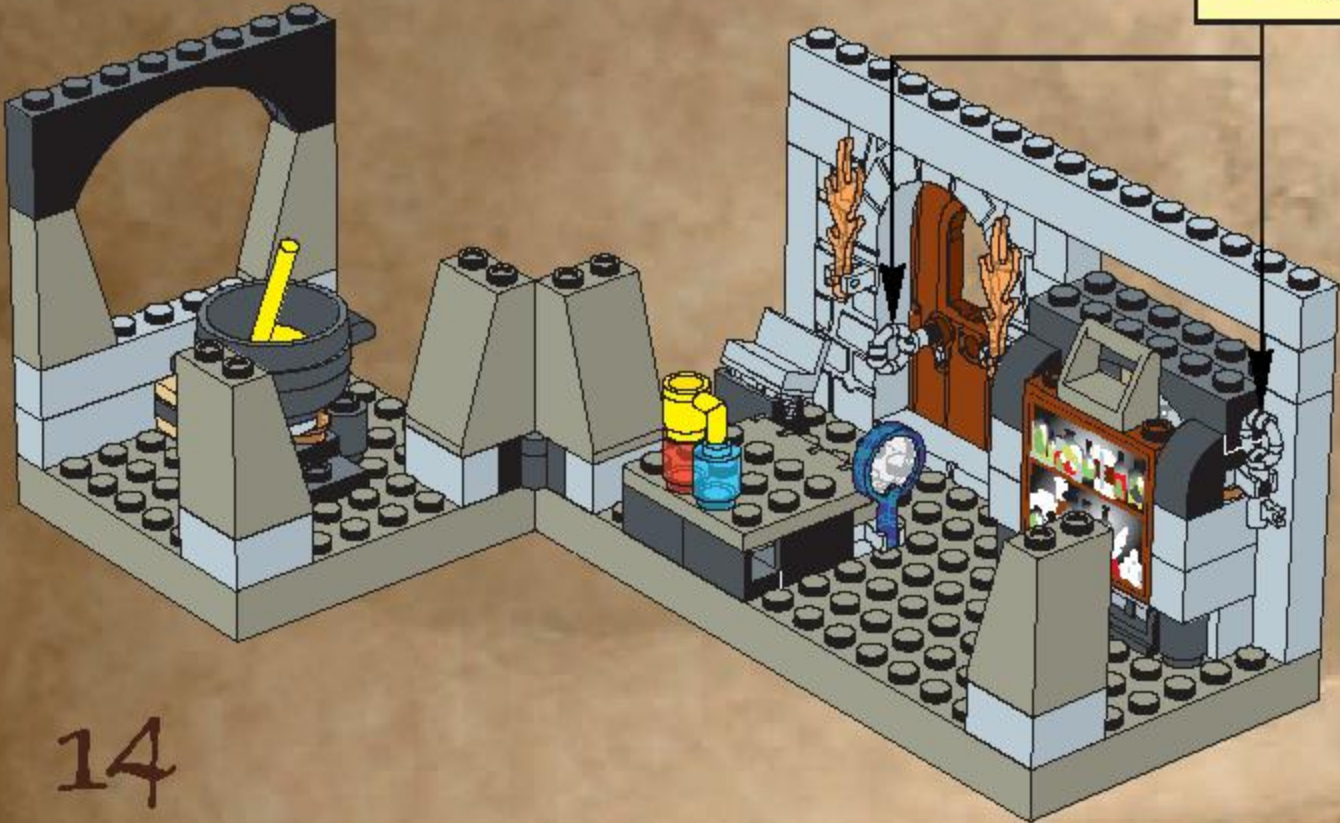

14

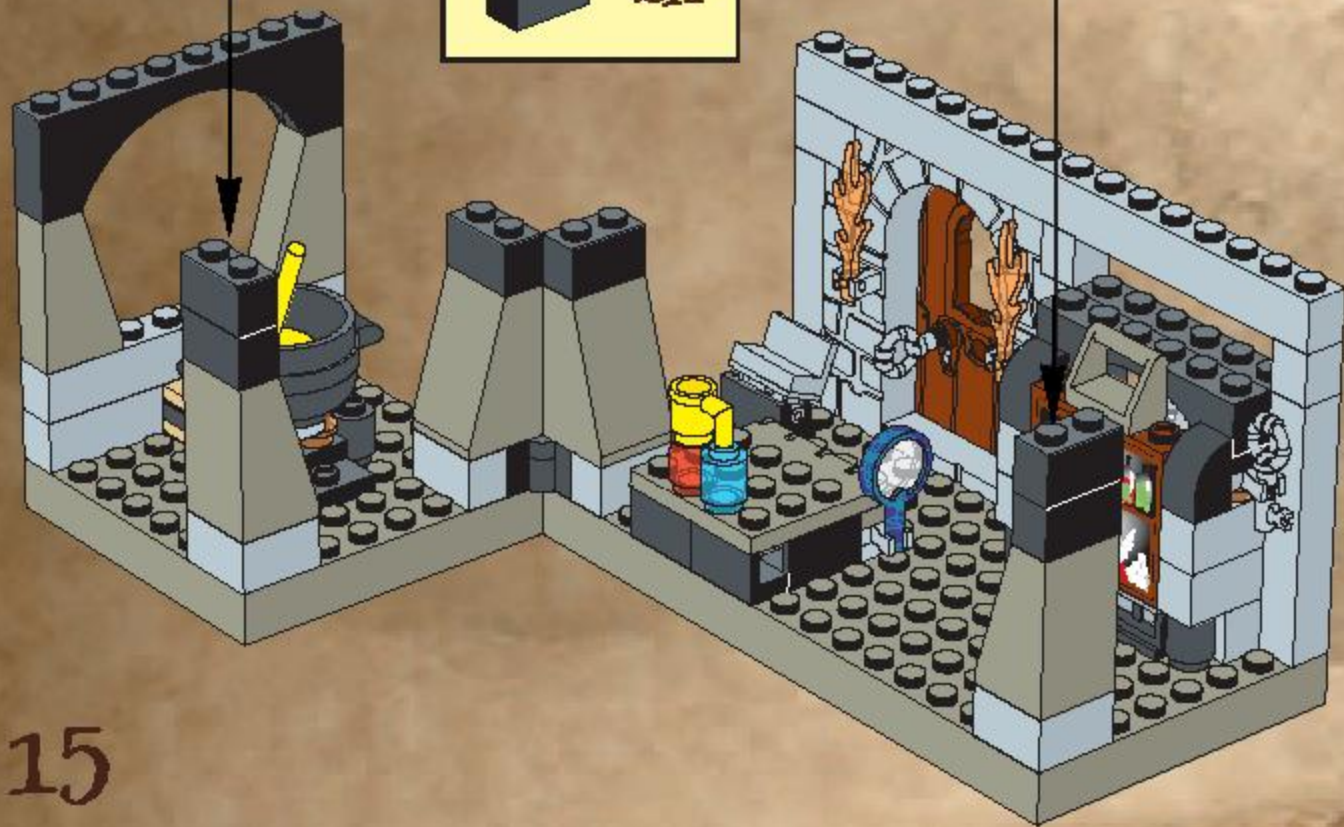
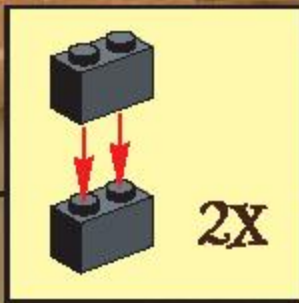

15

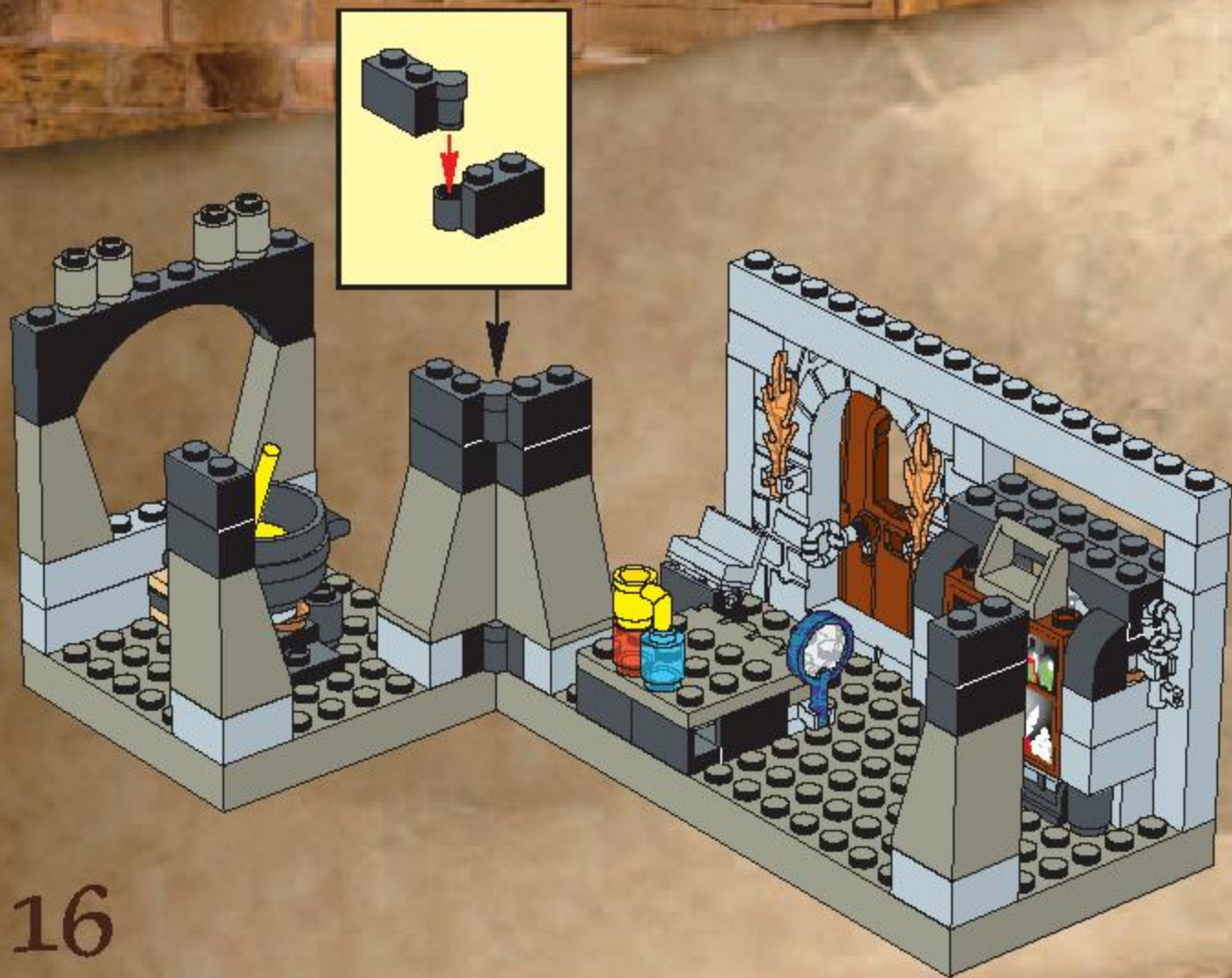

16

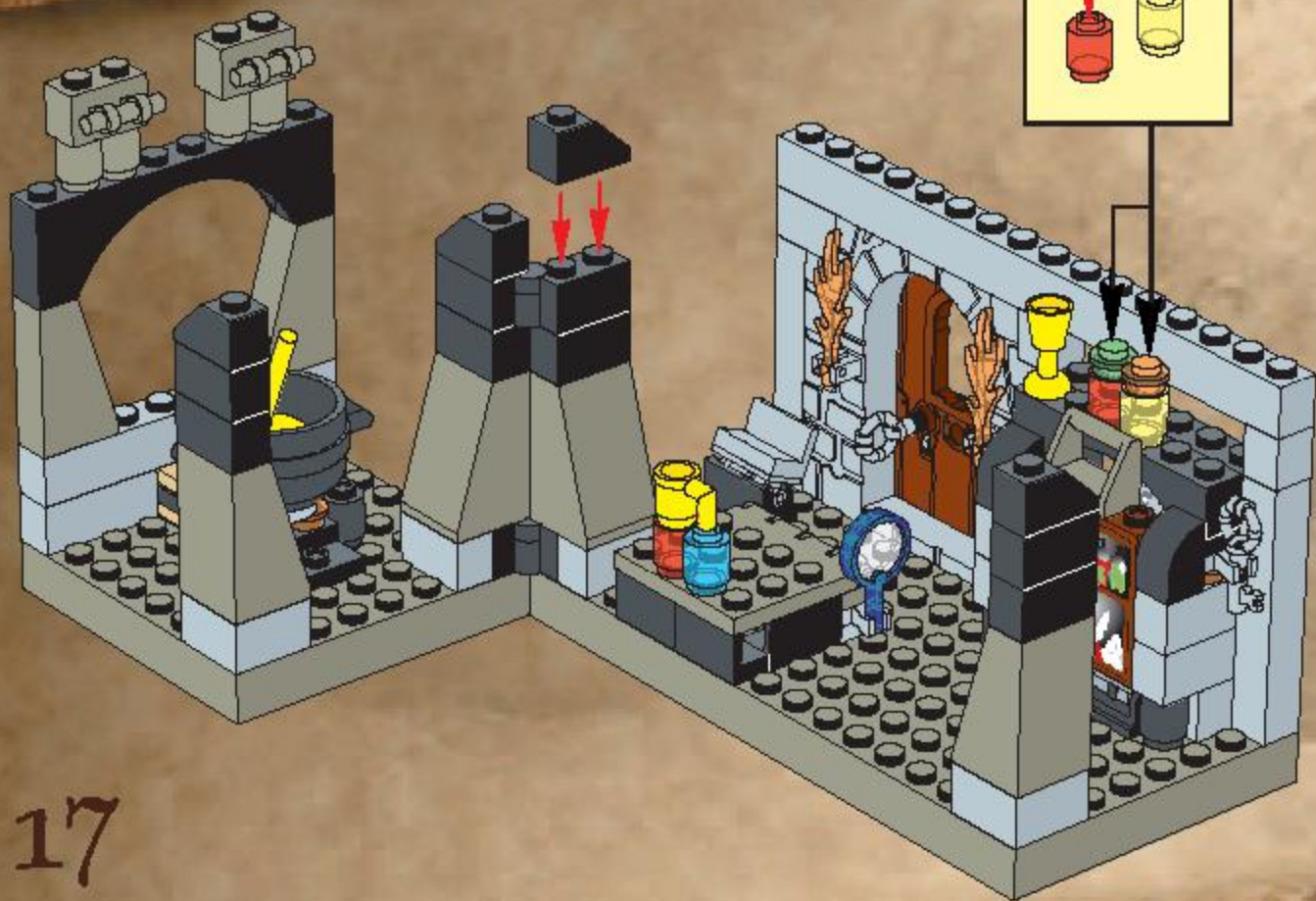

17

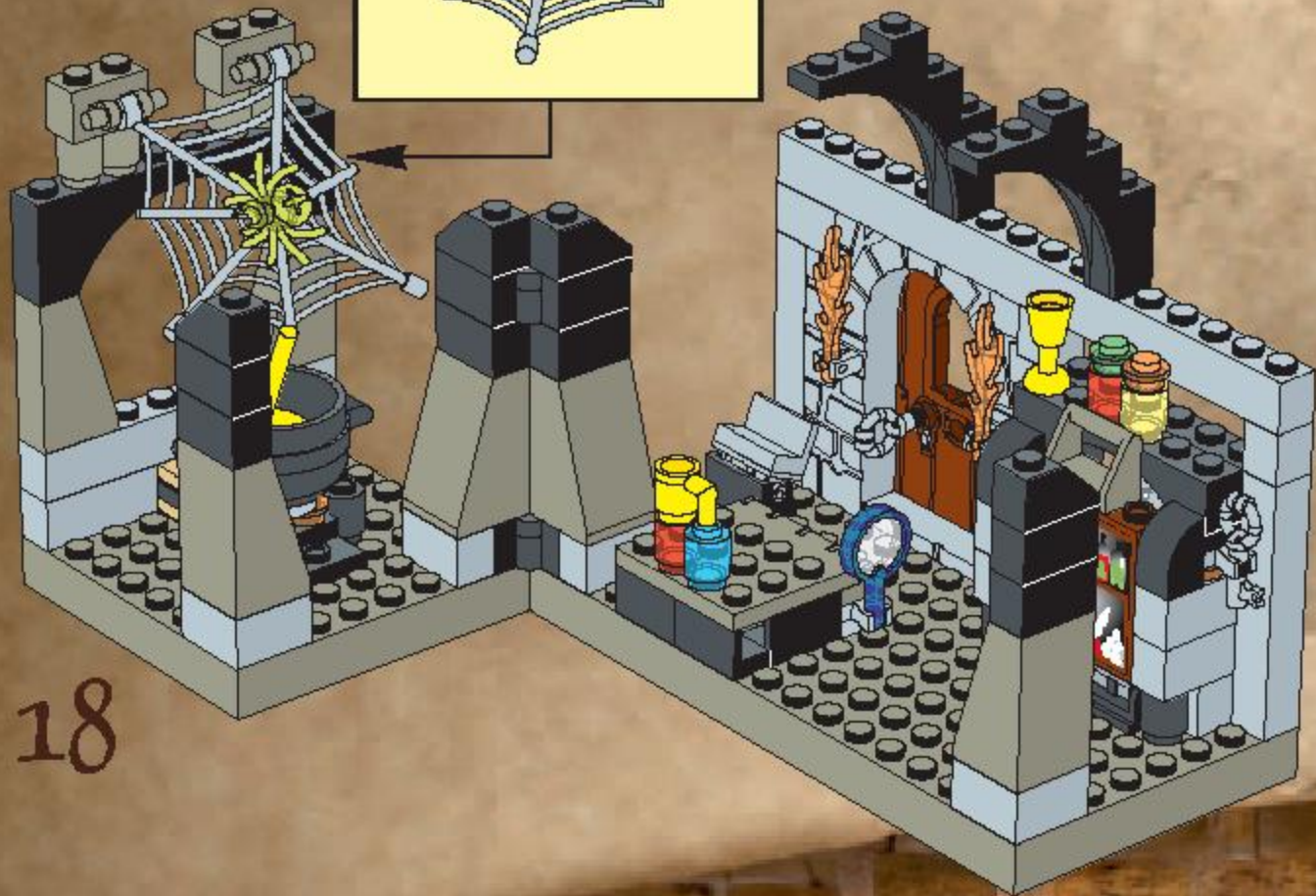
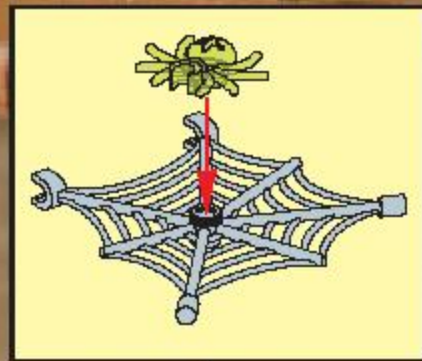

18

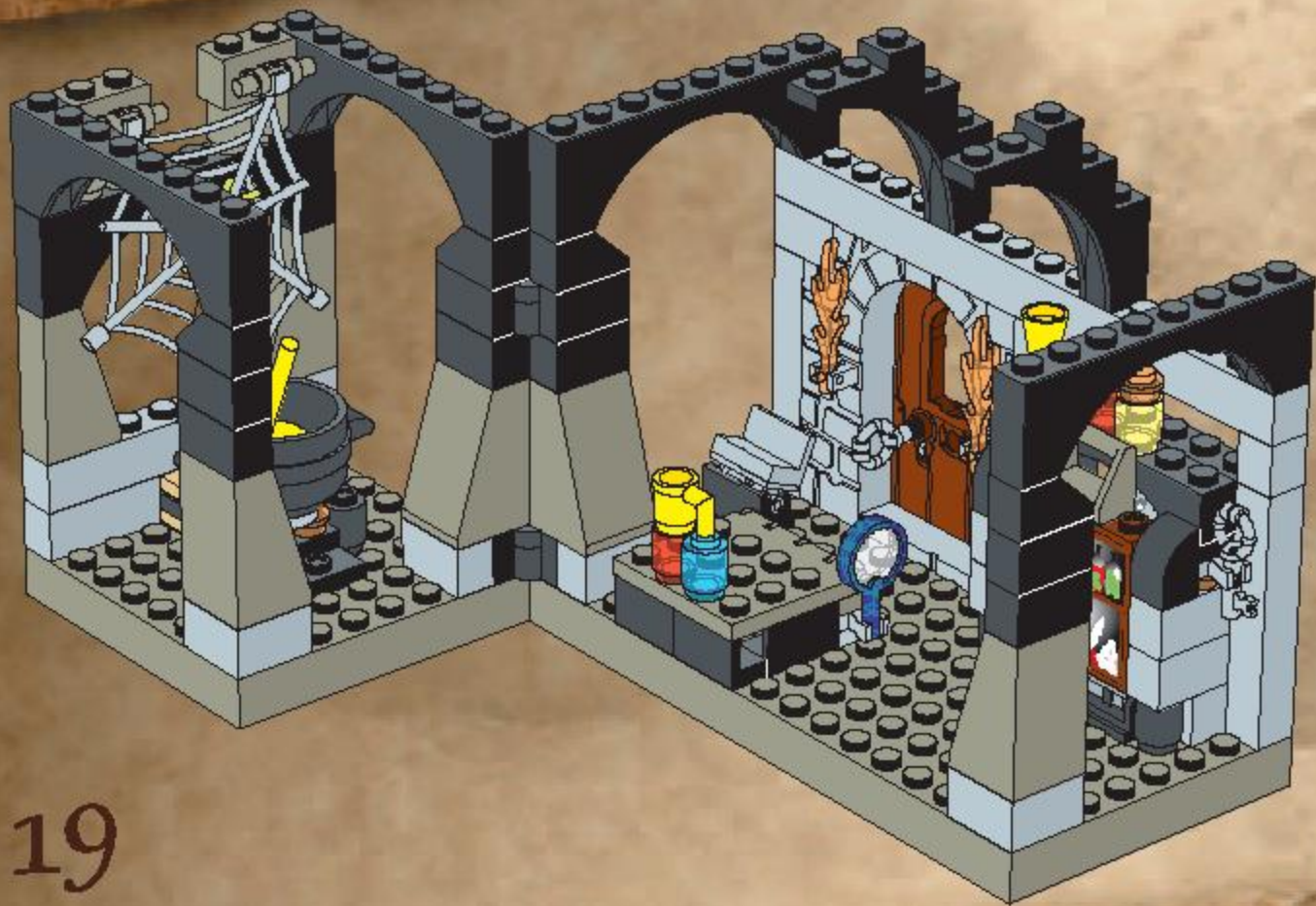

19



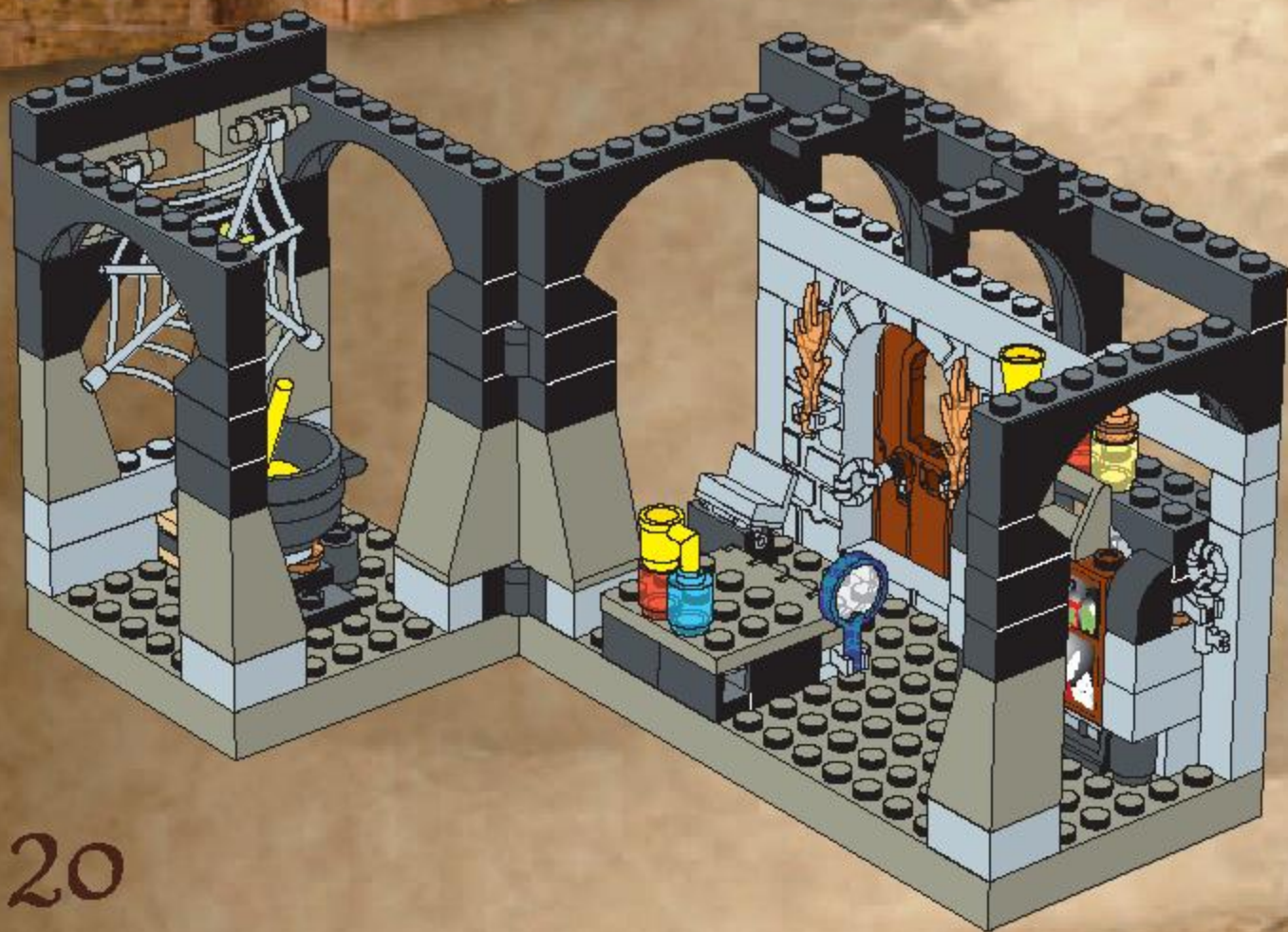

20

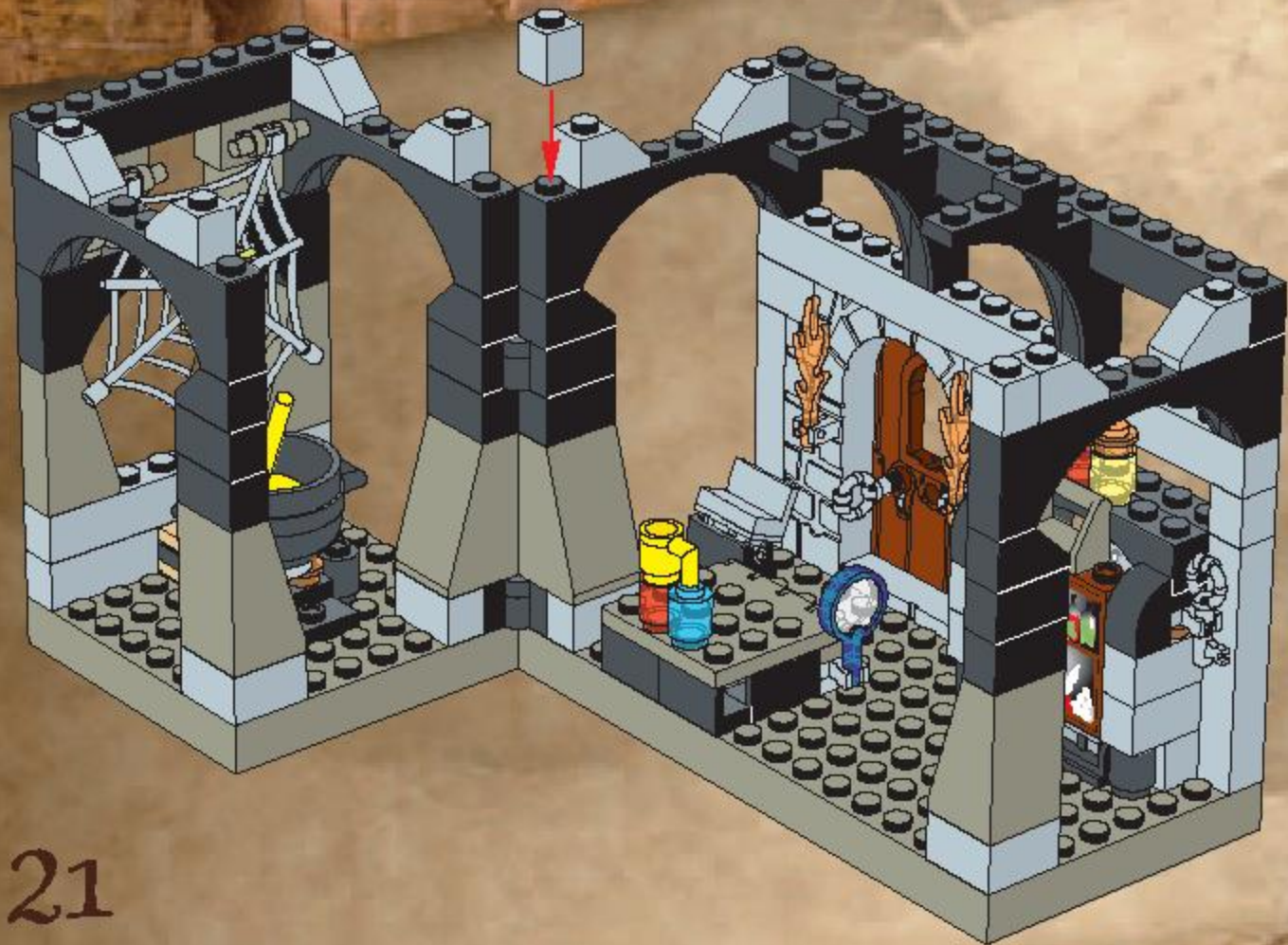

21

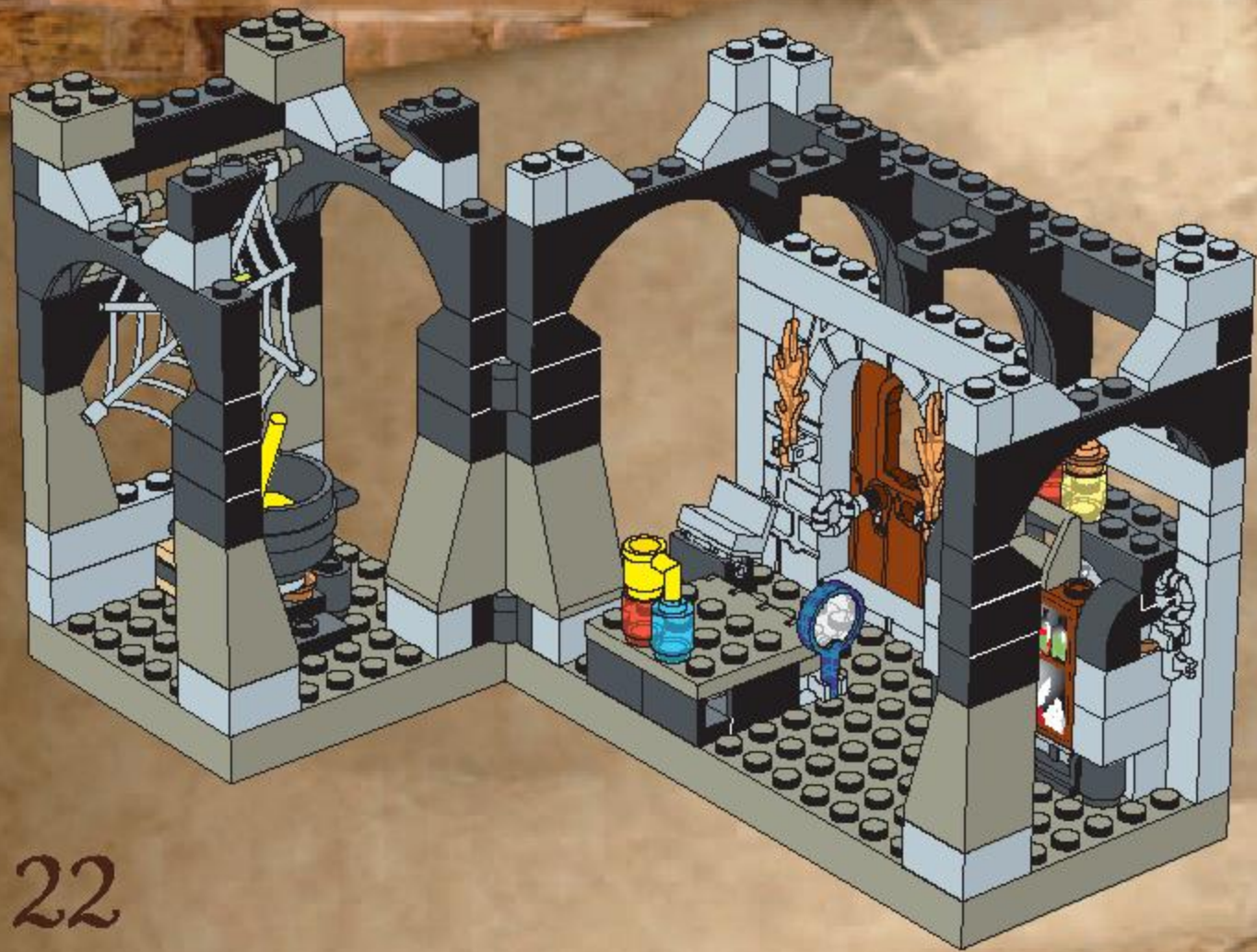

22

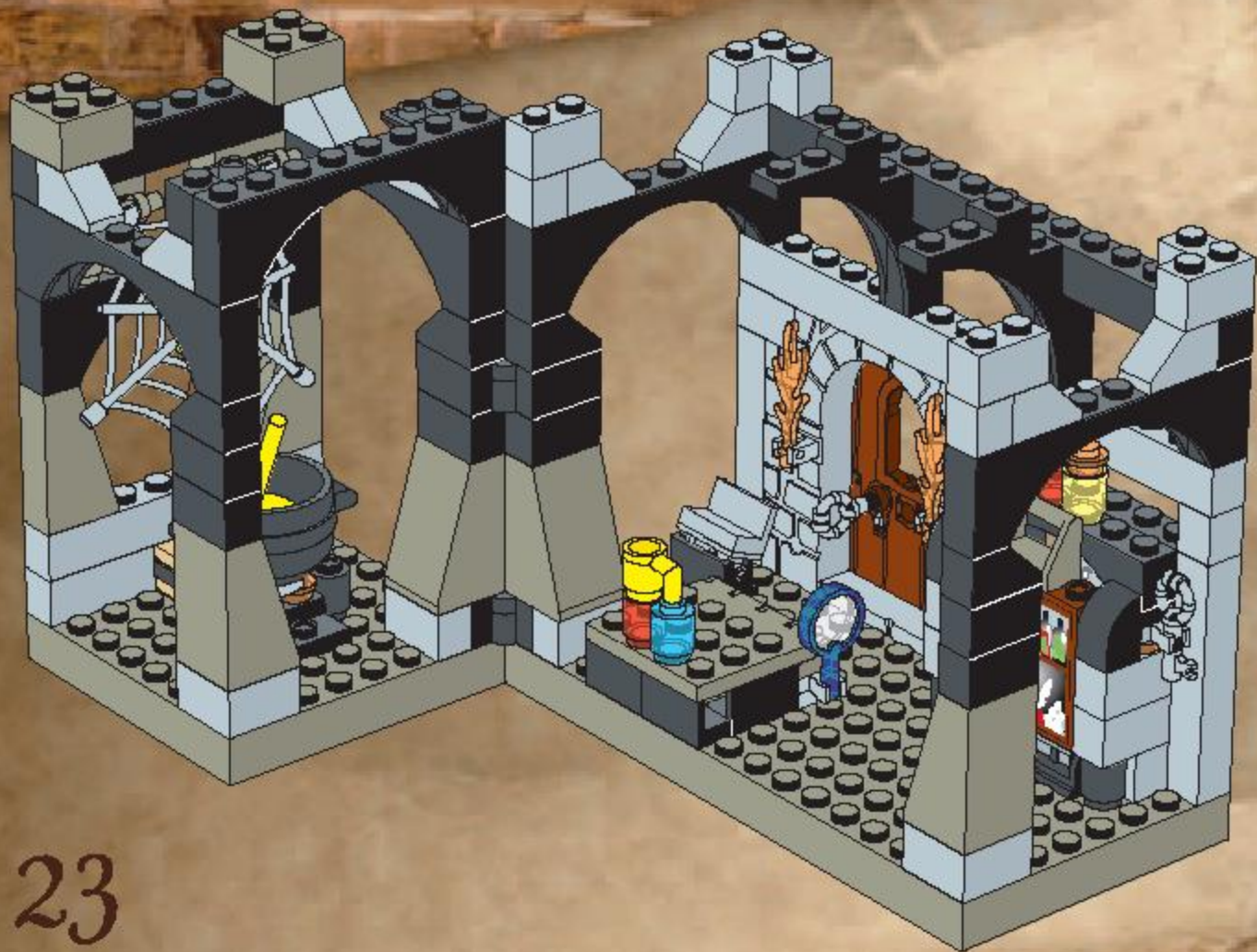

23

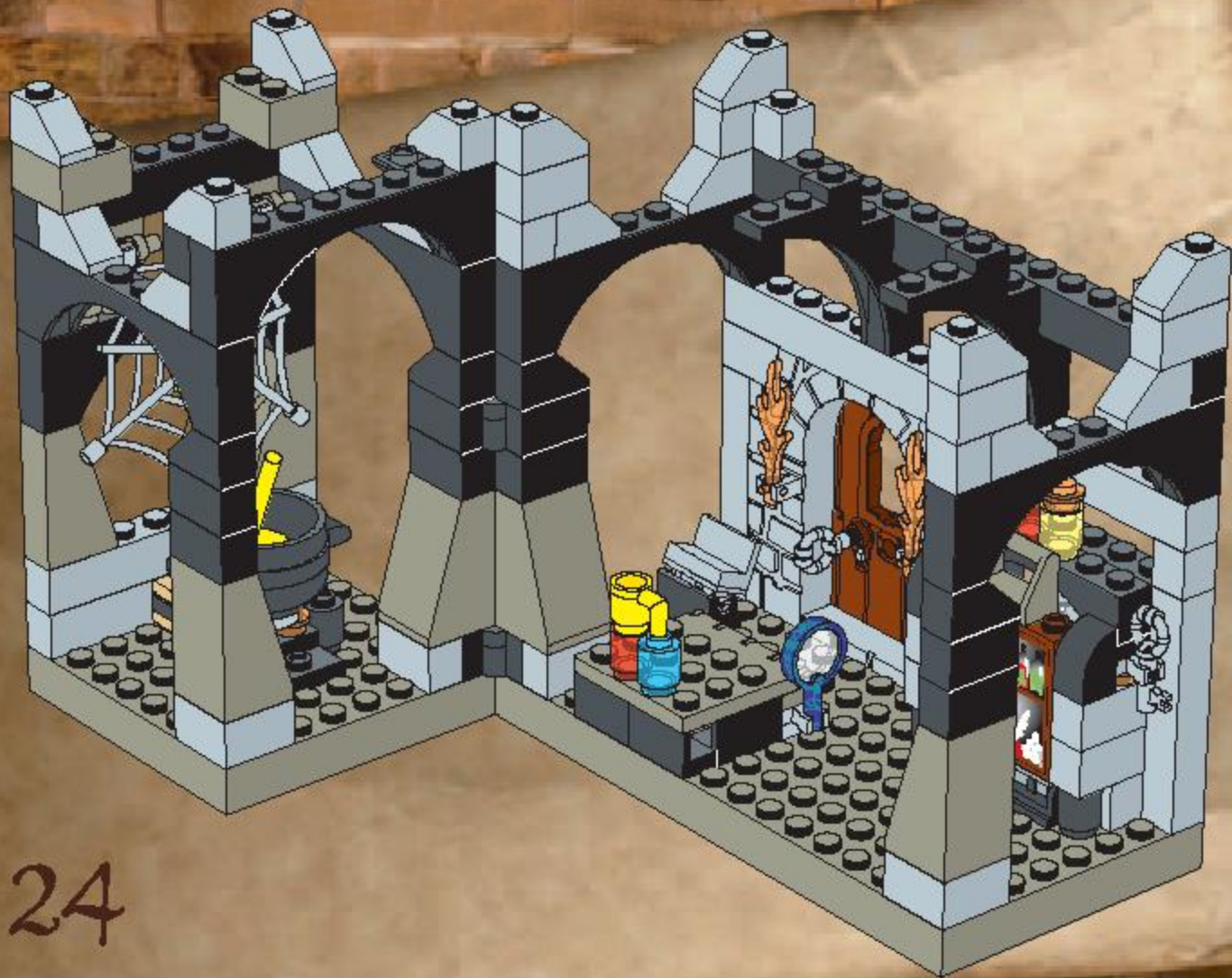

24

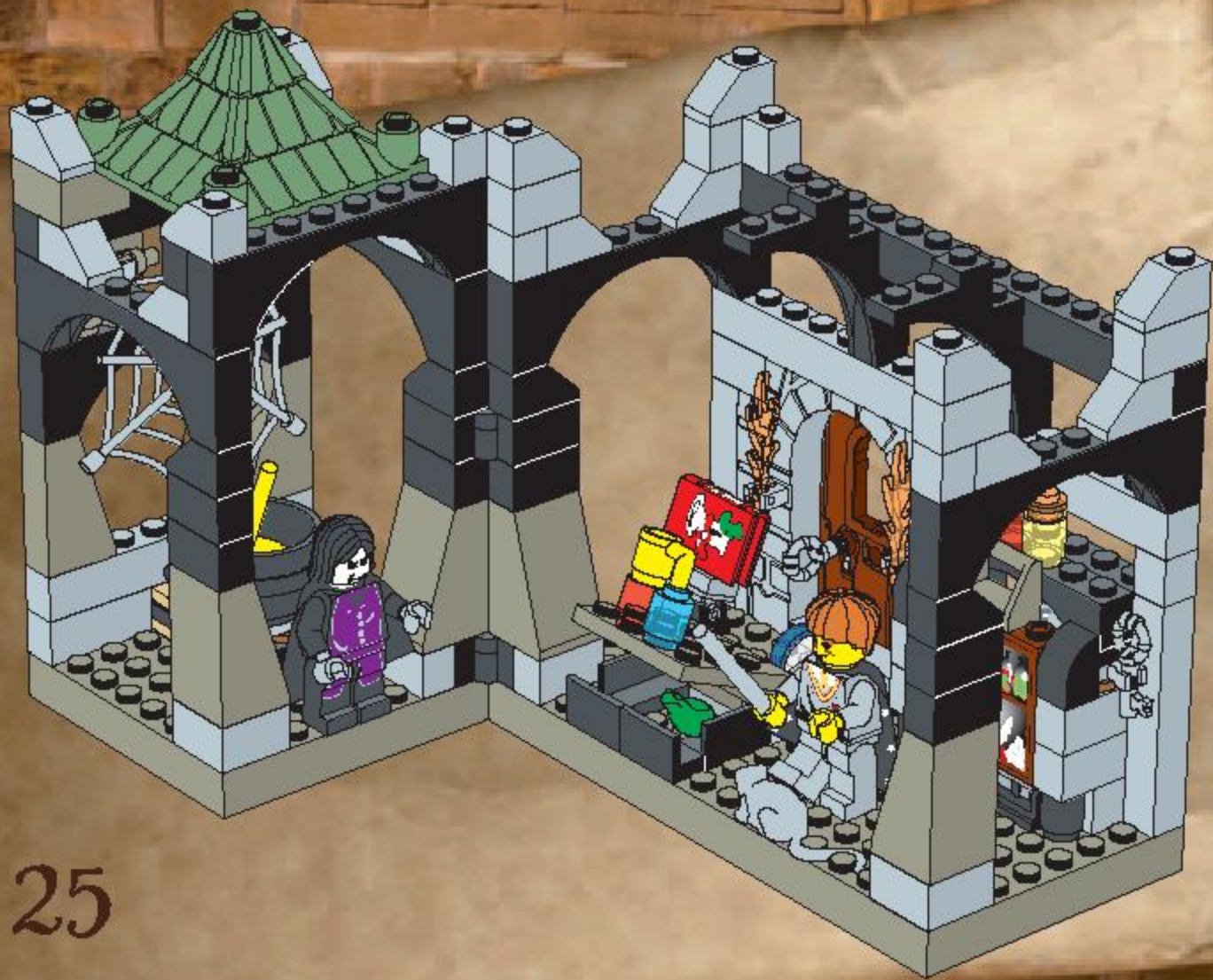



25

LEGO SOFTWARE



www.harrypotter.com



 HARRY POTTER, characters, names and related indicia are trademarks of Warner Bros. © 2001.
HARRY POTTER, characters, names and related indicia are trademarks of and © Warner Bros. (s01)
 WB SHIELD: TM & © 2001 Warner Bros.
© 2001 The LEGO Group.

4183047