



CREATOR

4918



3 IN 1

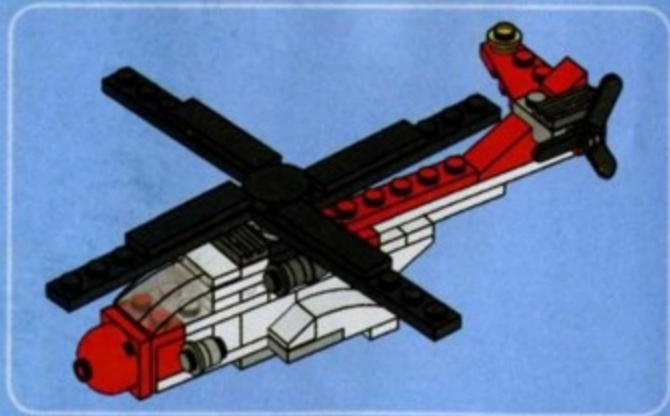

1

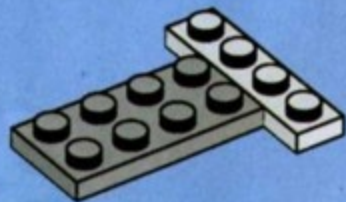

2

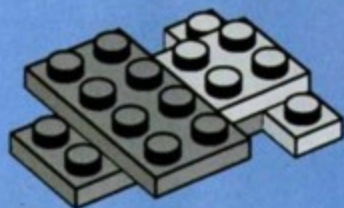

3

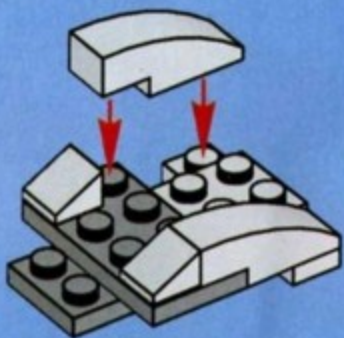

4

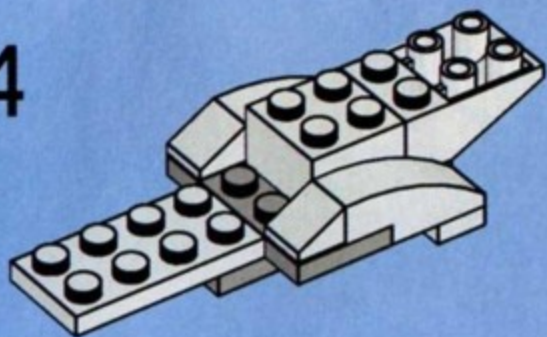

5

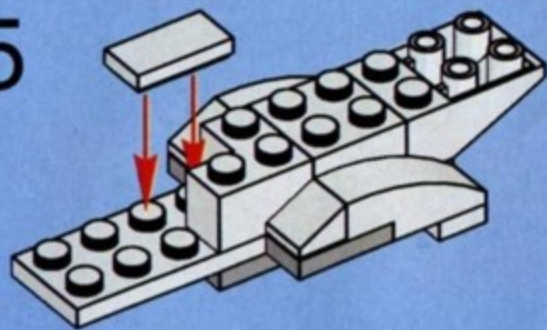

1



2



6

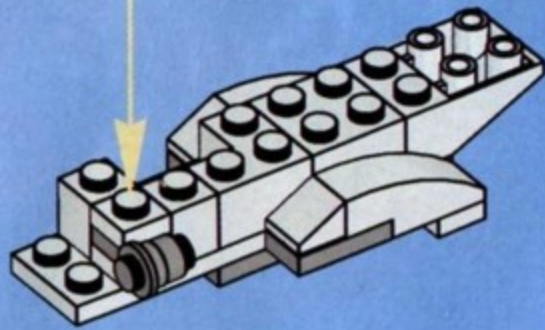

7

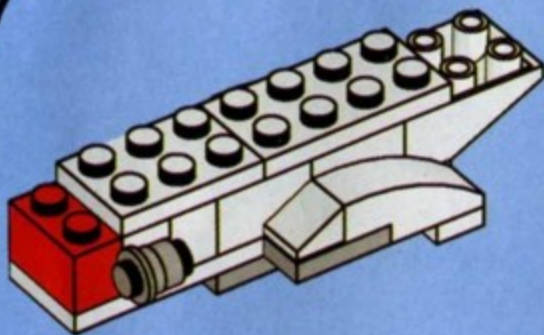

8

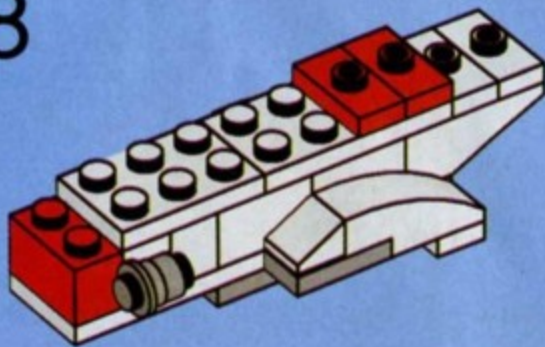

4

1

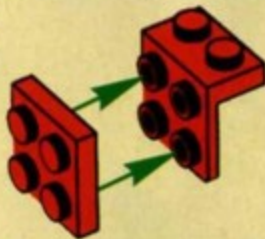

2



9

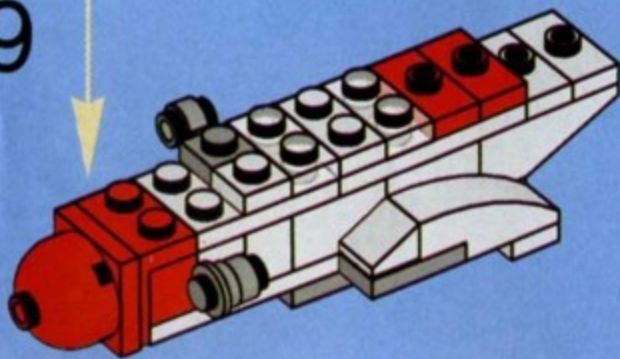

1

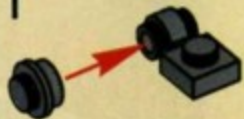

2



1



2



10

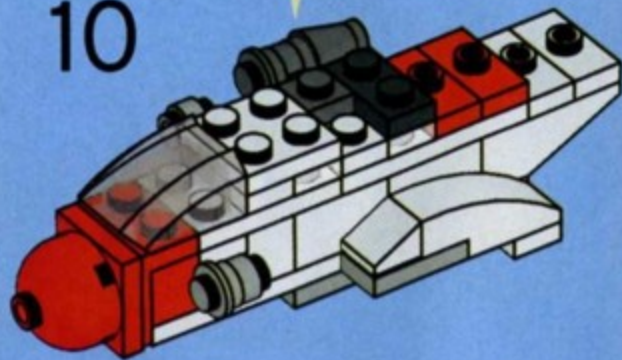

11

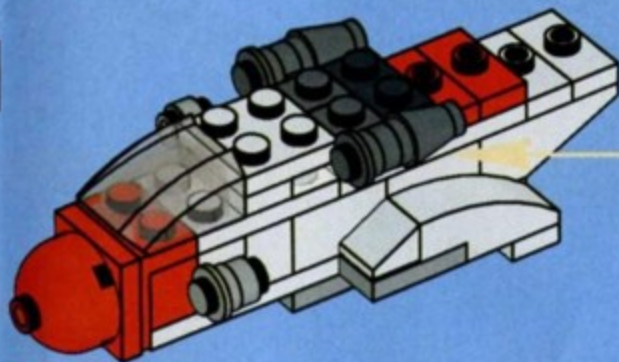

12

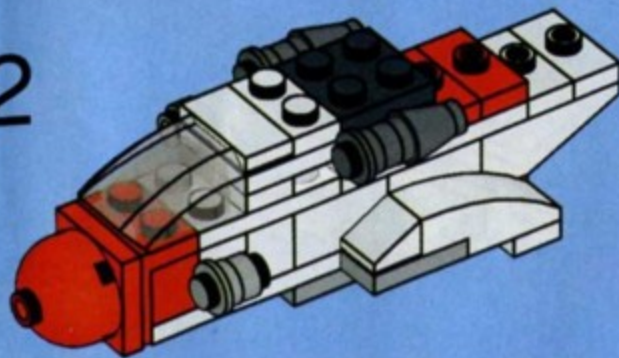

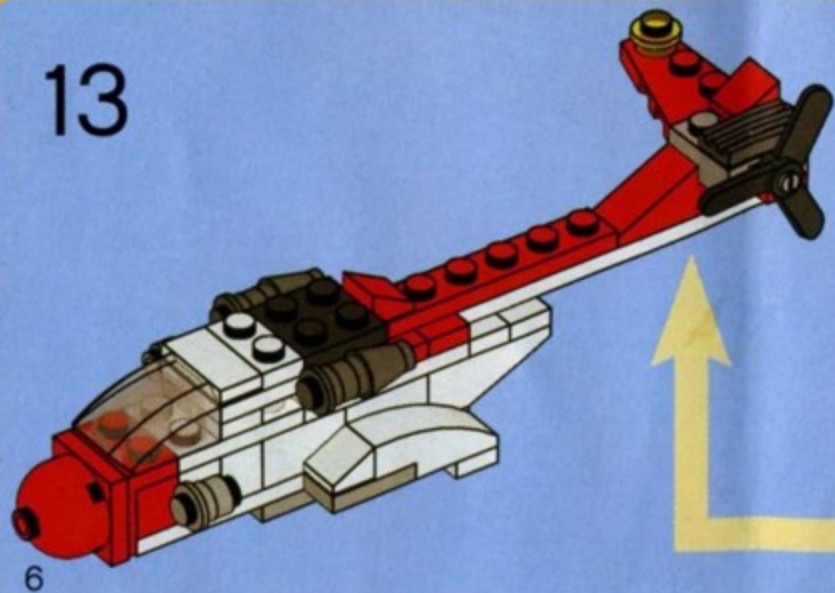
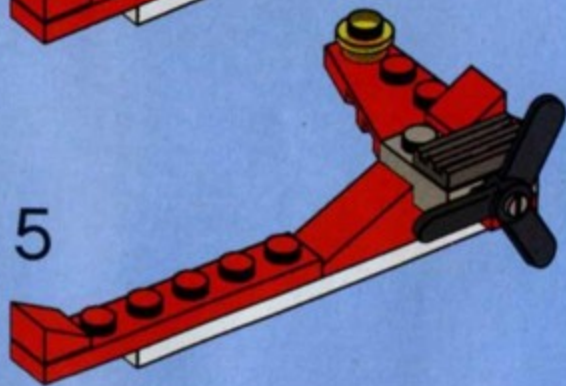
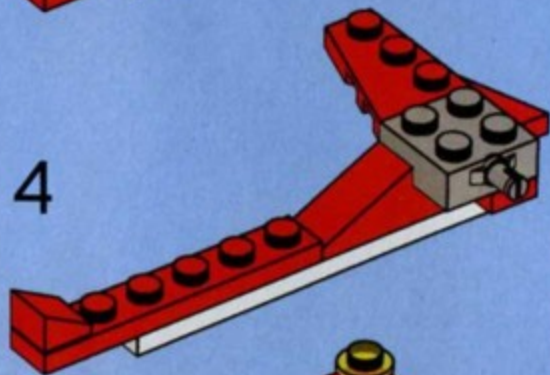
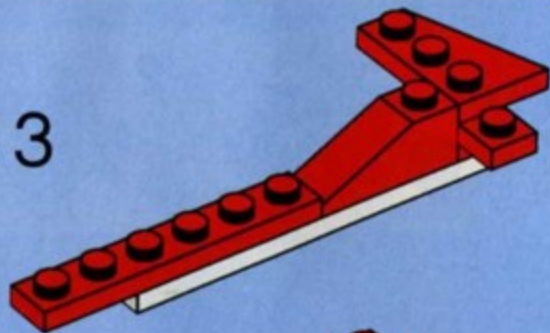
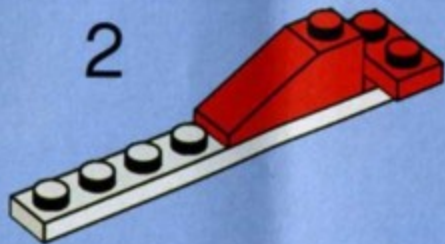
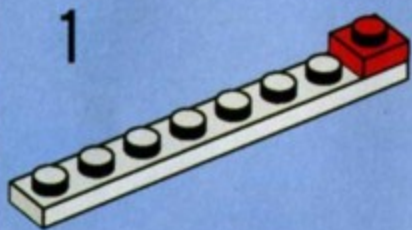

1



2



14

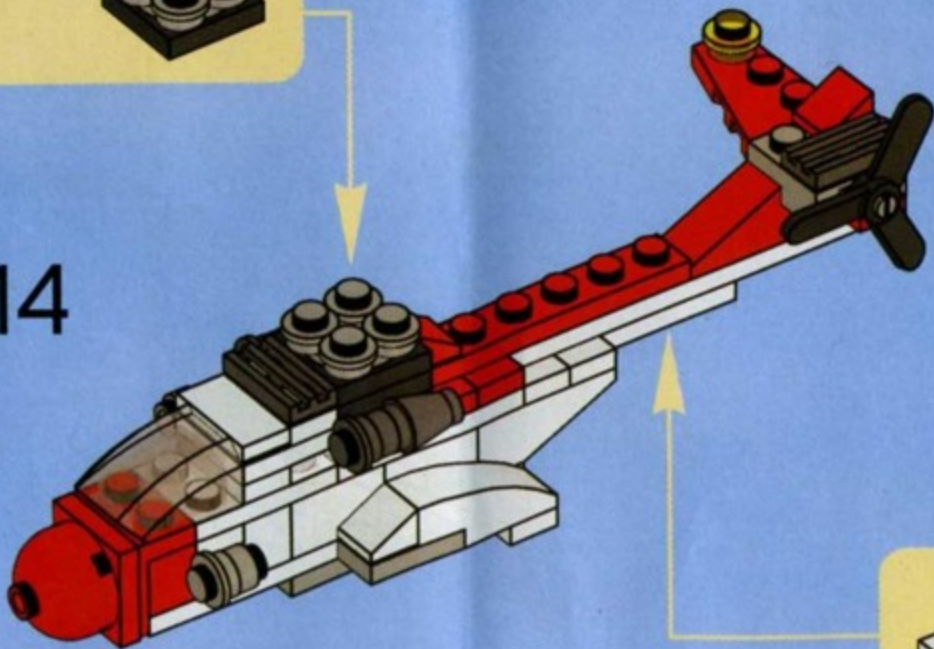

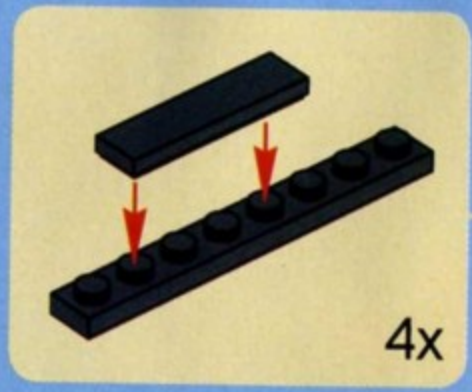

15

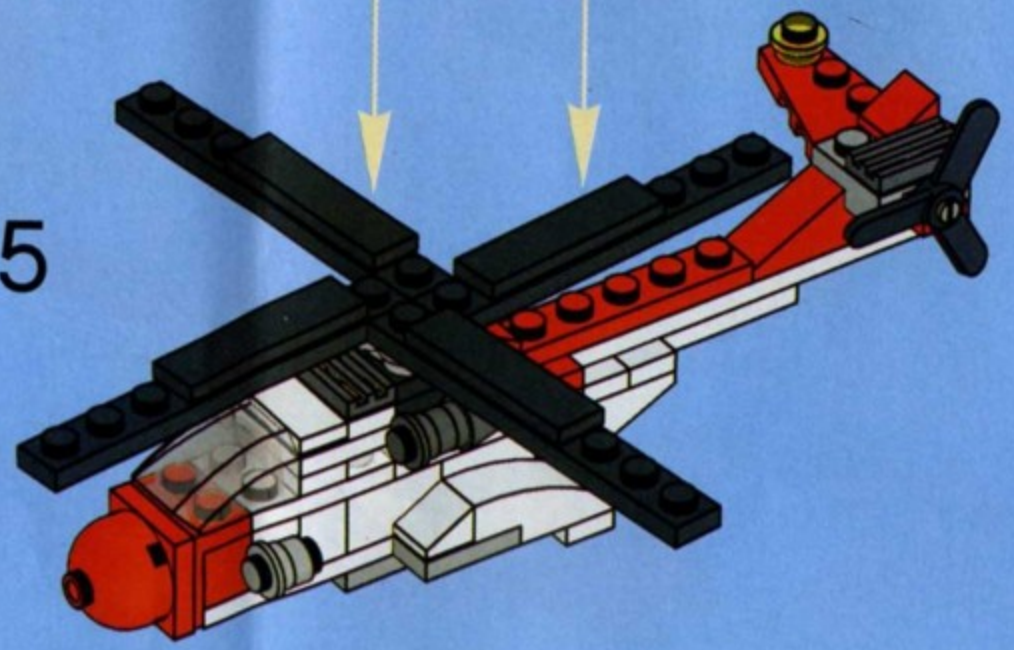

16

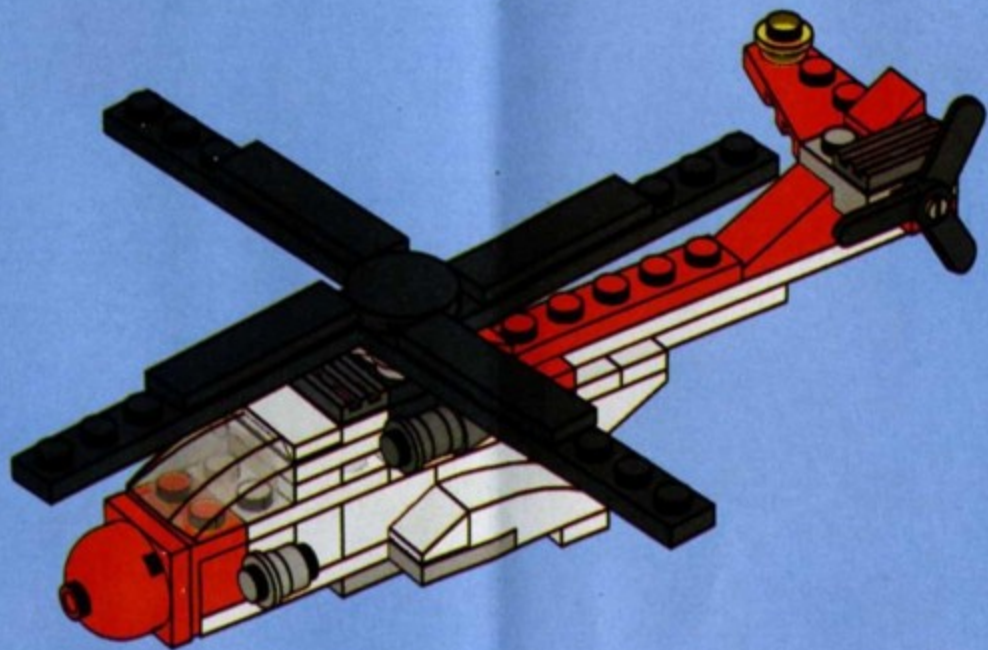

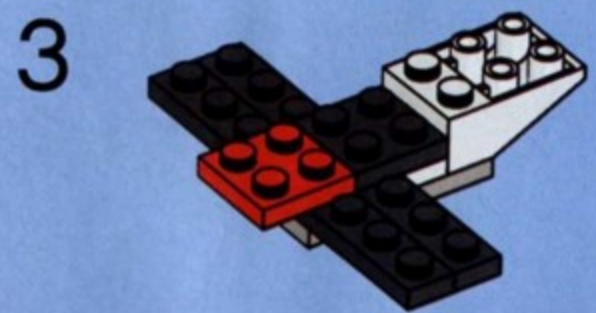
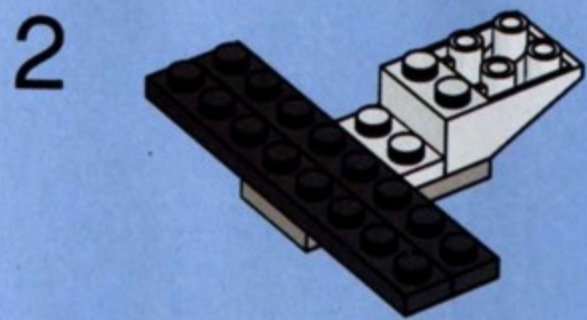
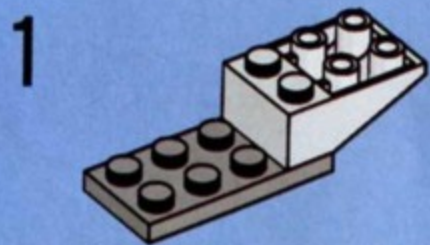
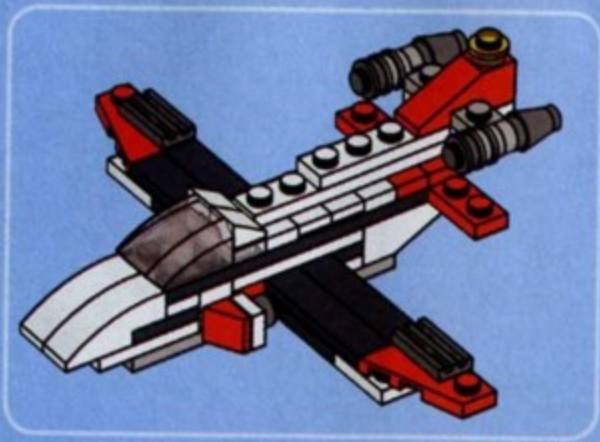

1

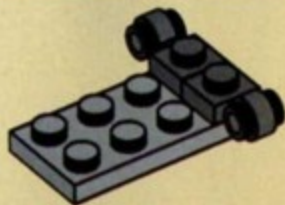

2

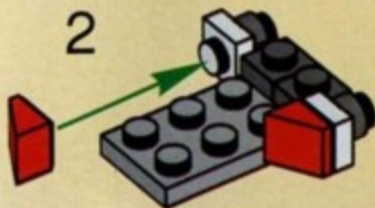

4

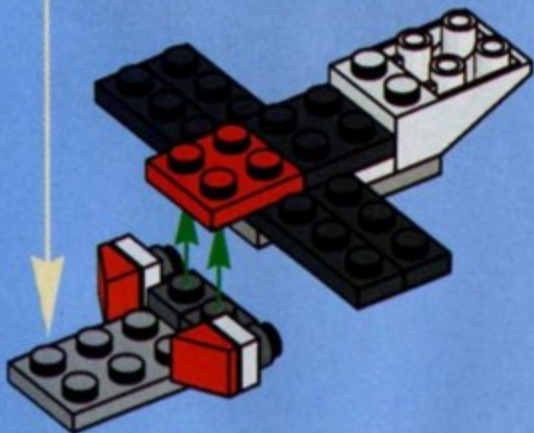

5

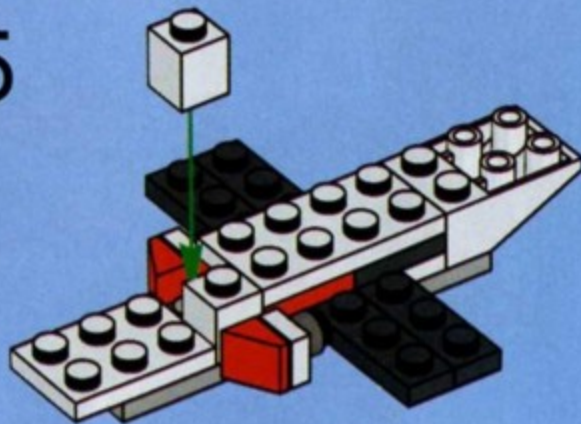

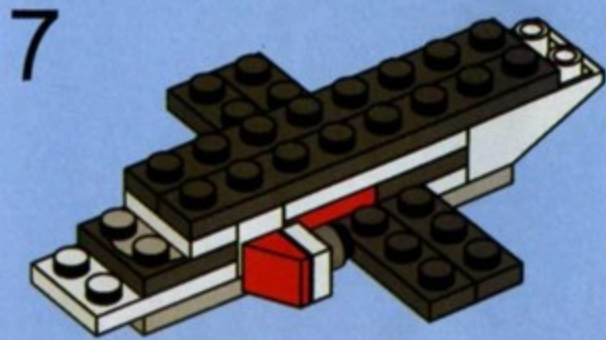
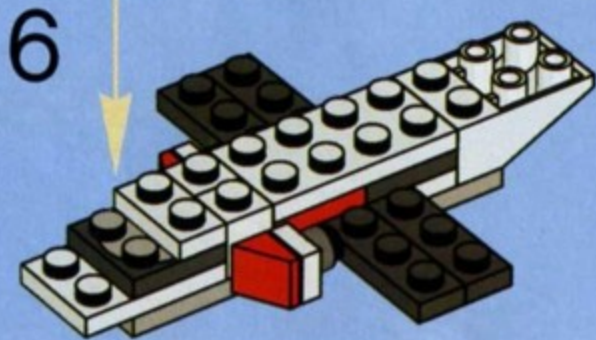
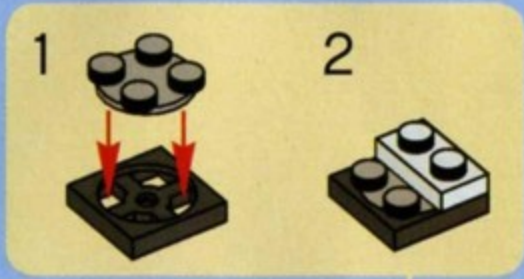

8

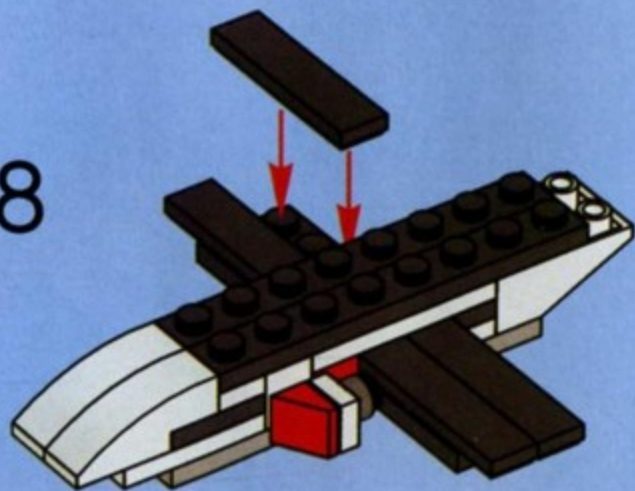

9

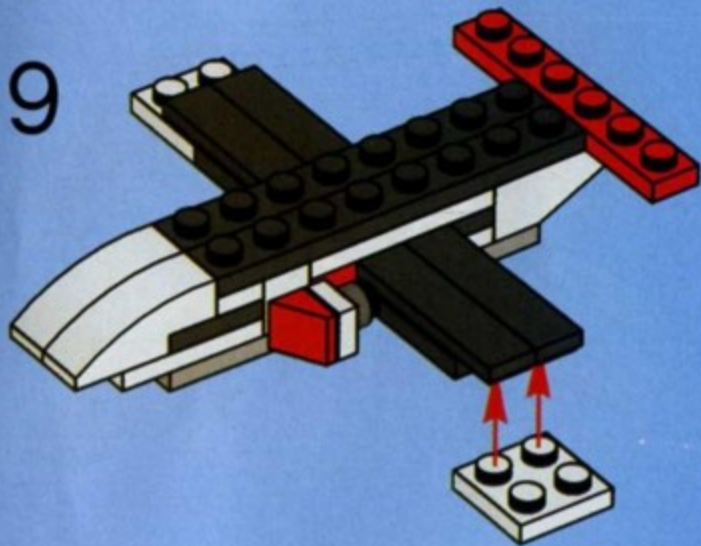

10

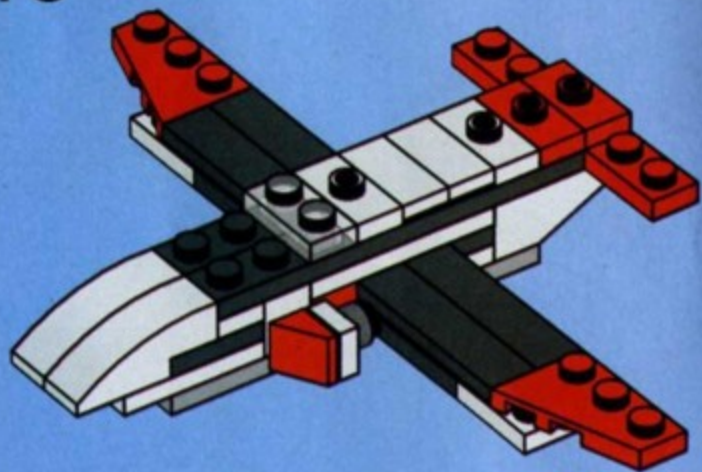

11

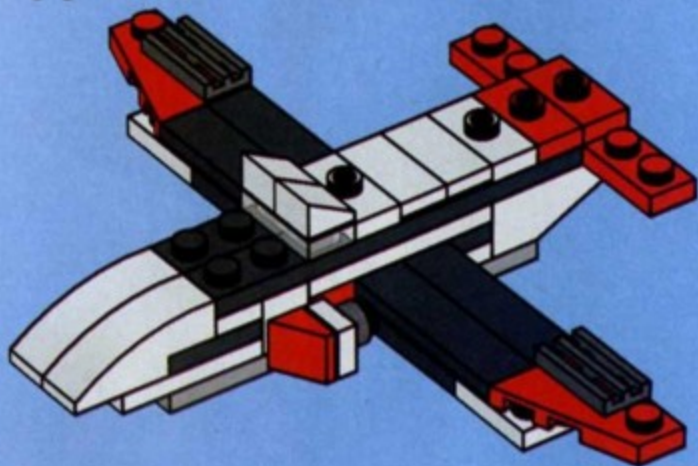

12

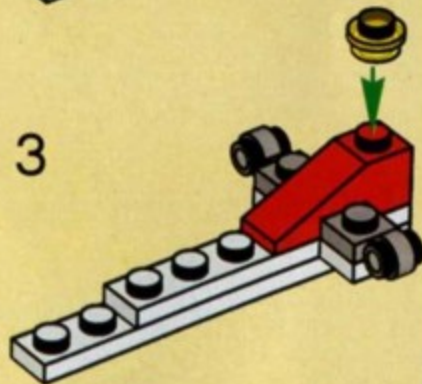
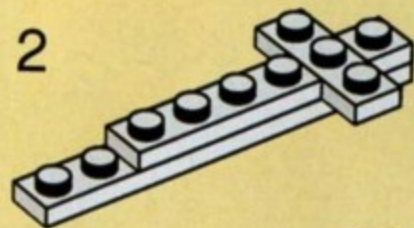
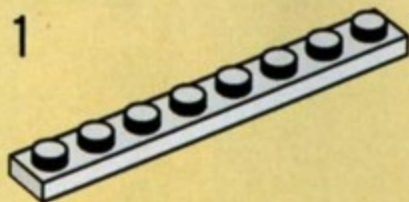
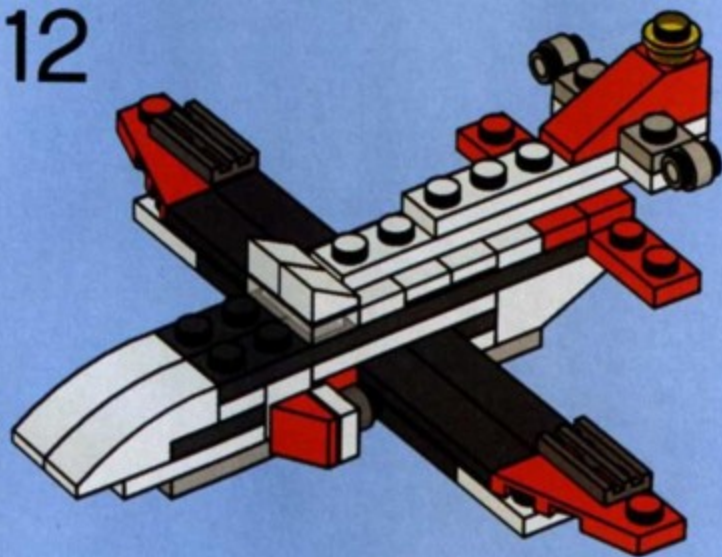

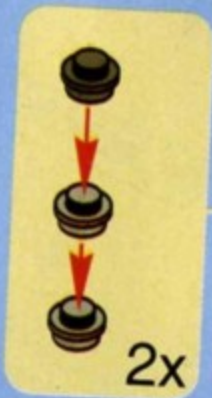

13

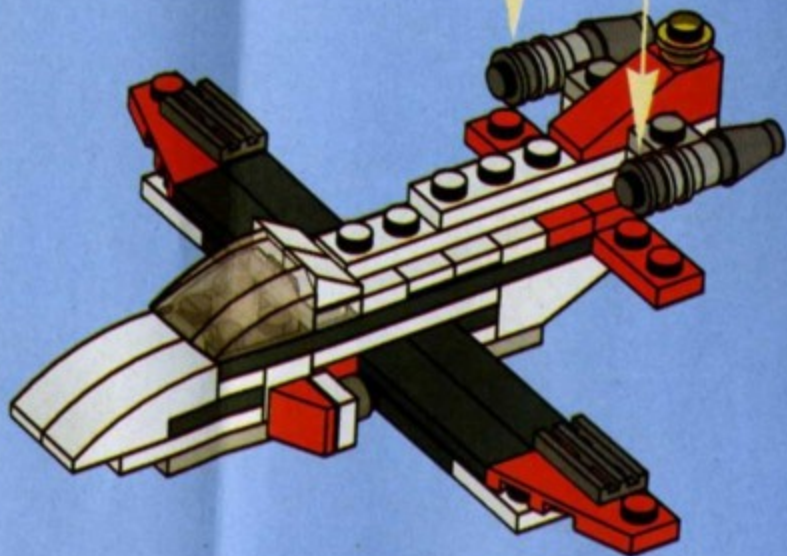

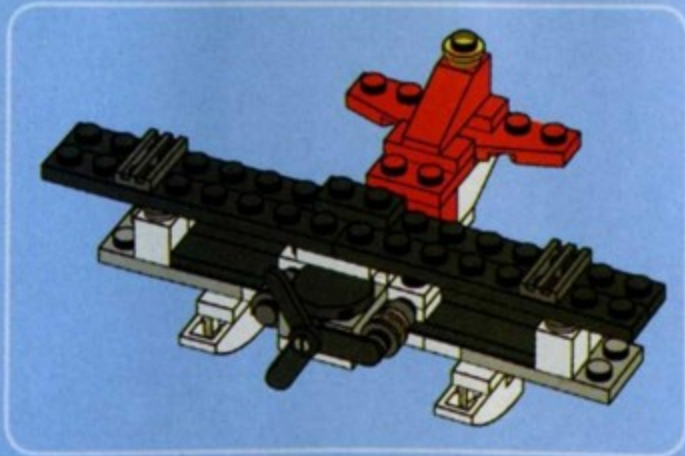

1

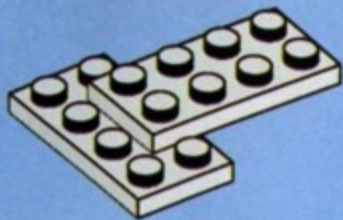

2

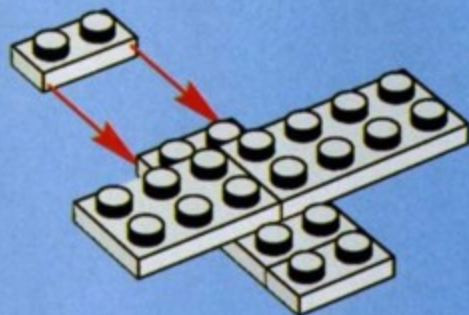

3

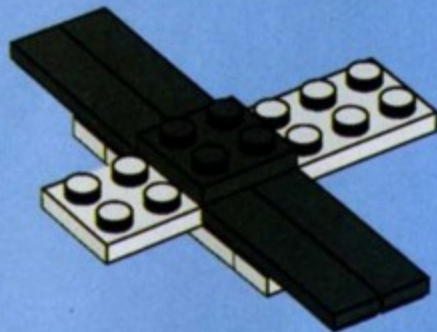

4

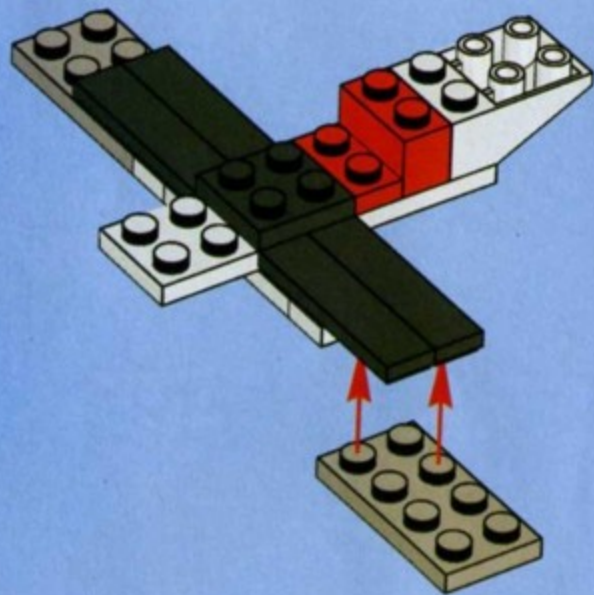

5

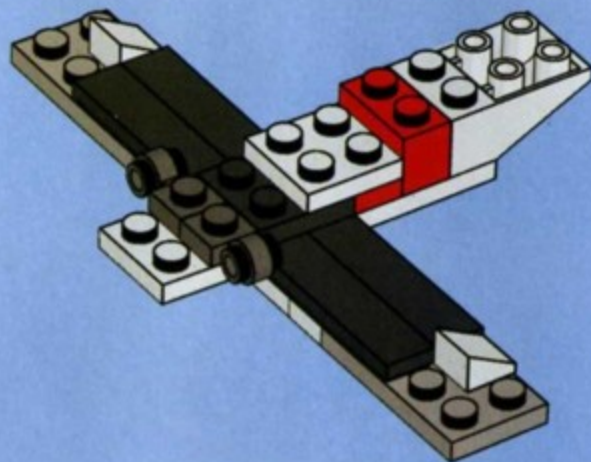

6

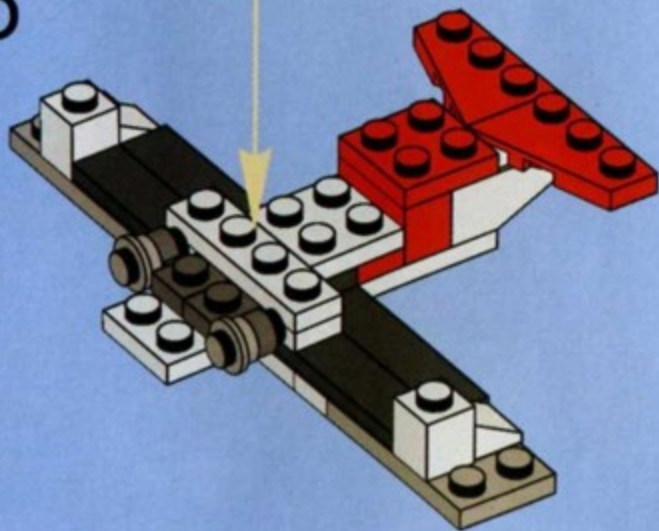
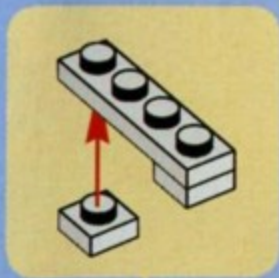

7

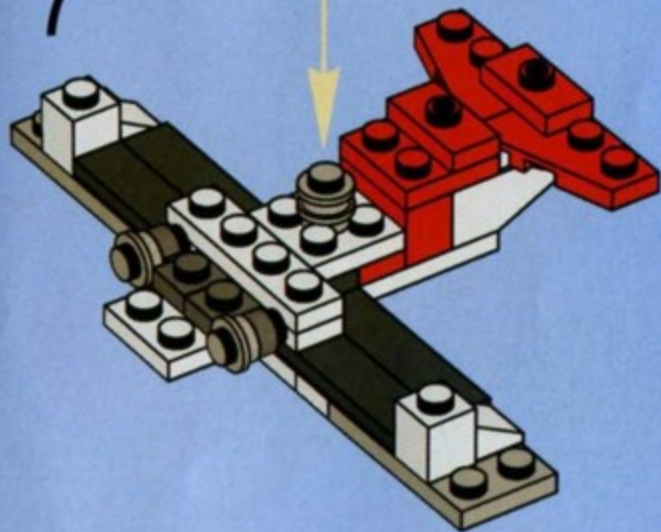
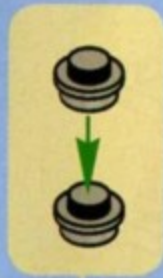

8

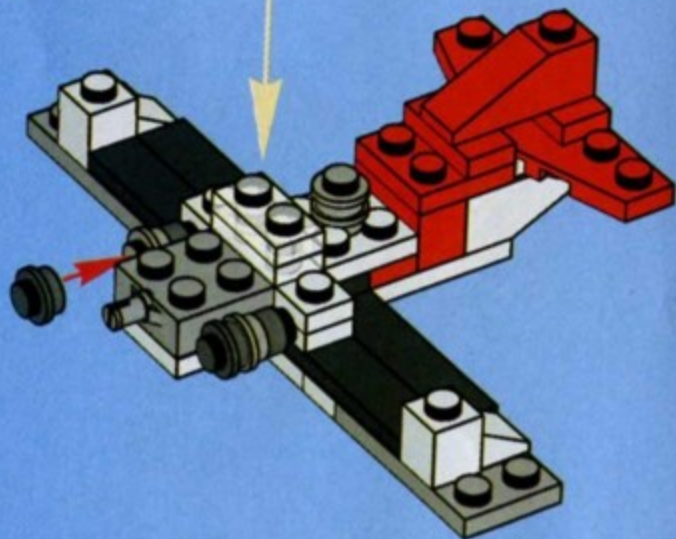
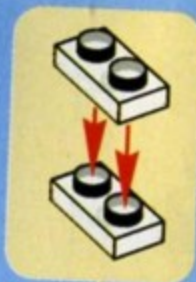

9

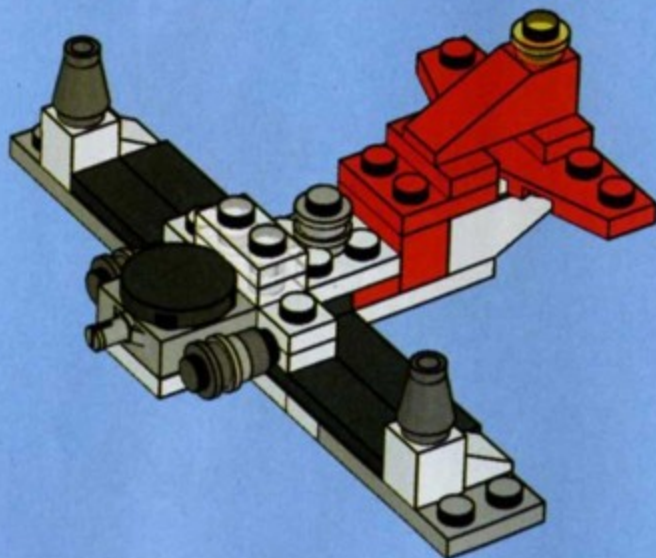

1

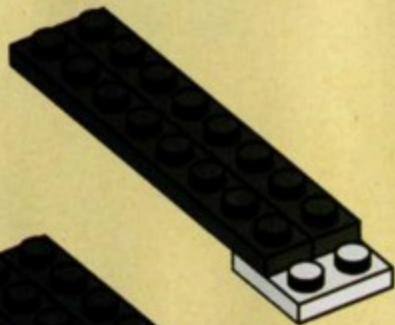

2

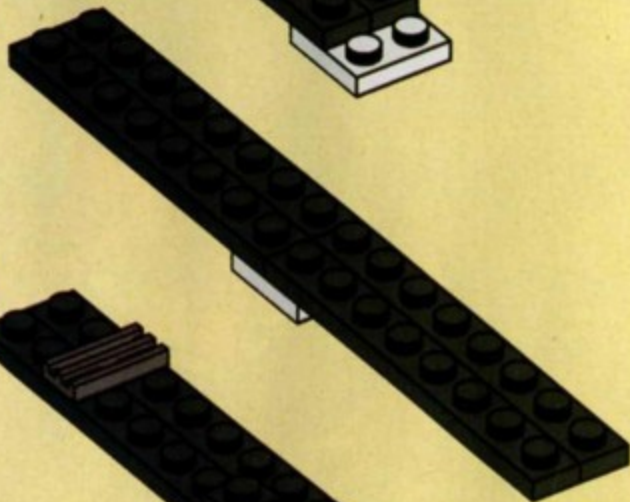

3

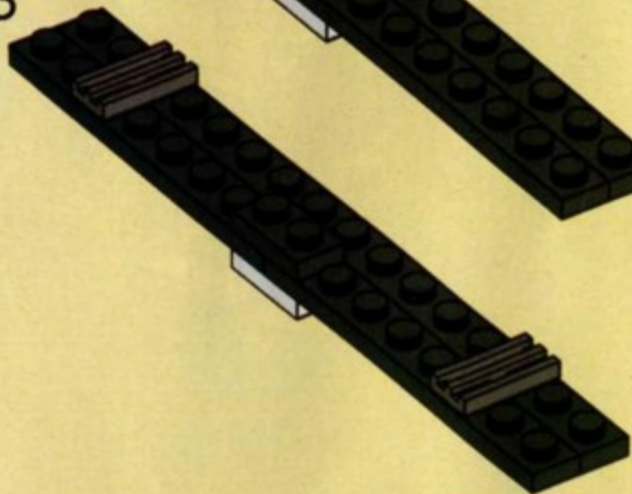

10

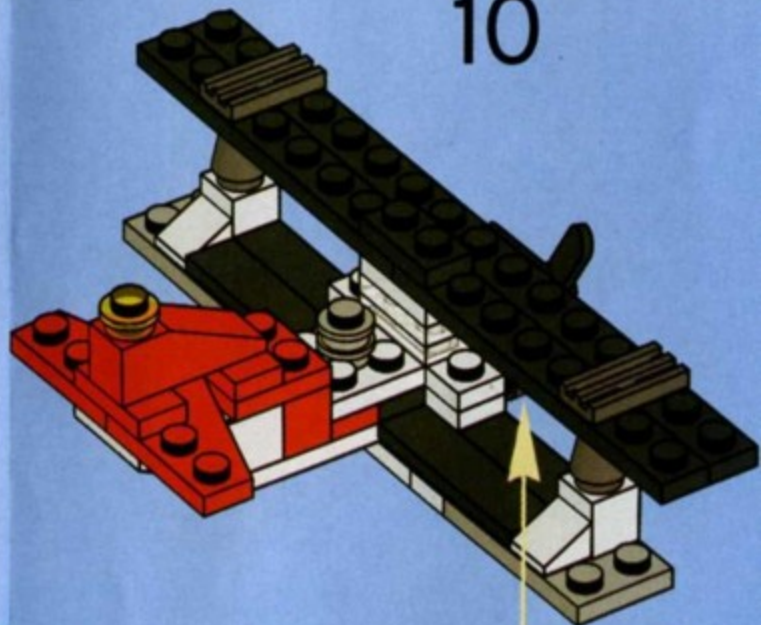

1

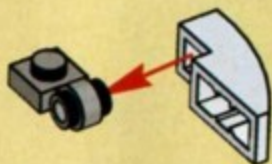

2

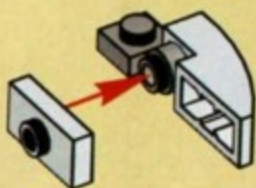

3

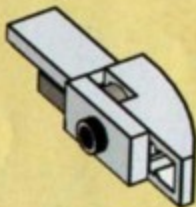

11

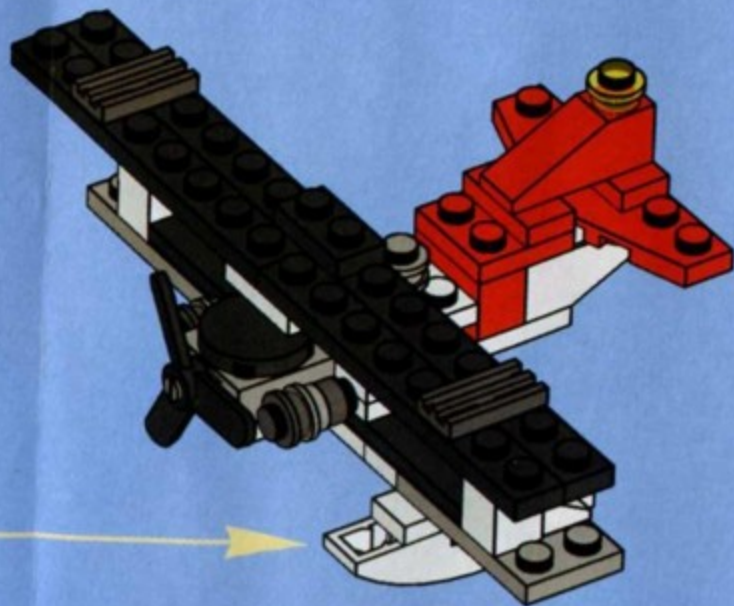

12

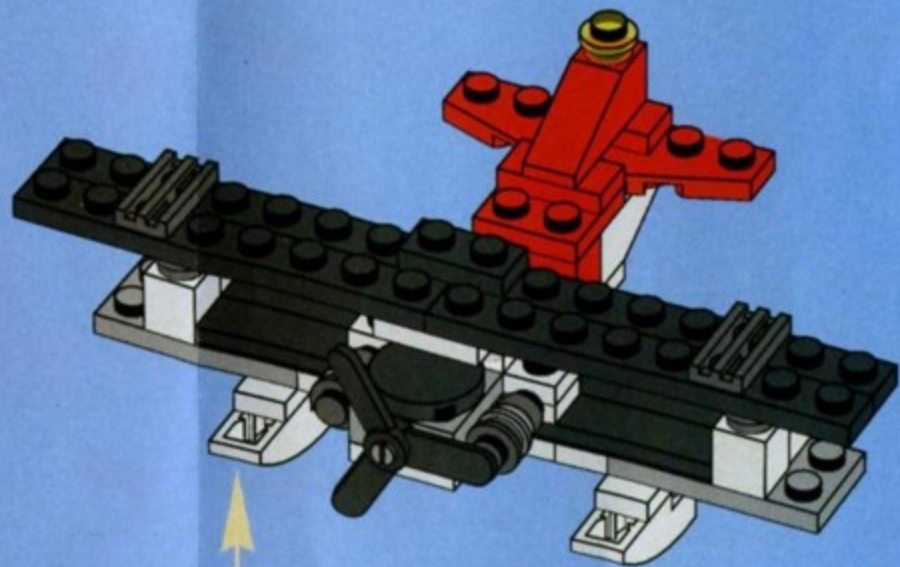
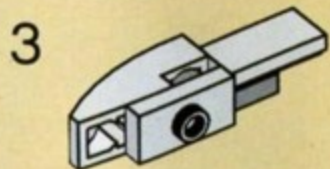
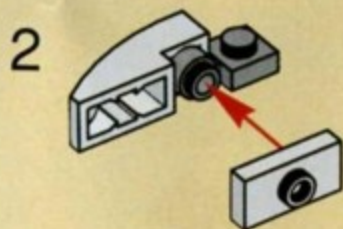
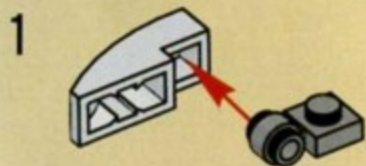



2x
300501



1x
300301



1x
235701



2x
4249112



2x
306901



3x
302401



2x
379401

24



2x
302301



1x
362301



1x
371001



1x
346001



2x
302201



1x
302101



2x
302001



2x
4210828



2x
4210647



2x
4210631



2x
4210633



2x
4244370



1x
4500469



2x
4167842



1x
4211496



2x
4211477



2x
4211395



5x
4211525



1x
4495467



1x
4217722



1x
3005744



1x
4277933



1x
300421



1x
4216657



1x
302421



1x
302321



2x
379421



1x
366621



1x
302221



1x
4180533



1x
4180504



2x
4244371



1x
428621



4x
243126



1x
415026



1x
302326



4x
346026



1x
302226



1x
4289255



1x
368026

