



10026

# STAR WARS



Building Toy  
Jouet de Construction  
Juguete para Construir

Cont.  
107 pcs/pzs

9+

ULTIMATE COLLECTOR SERIES  
SÉRIE ULTIME POUR COLLECTIONNEUR

# NABOO Starfighter

4192054



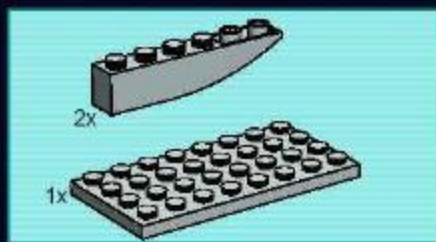
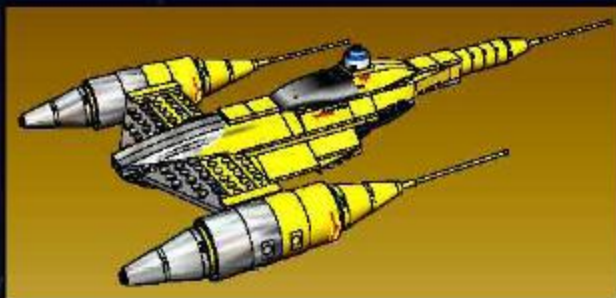

1

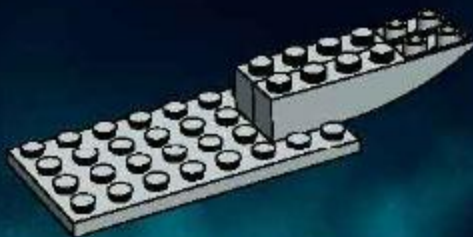

2

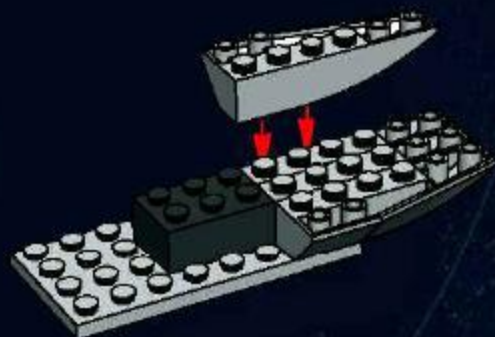



3

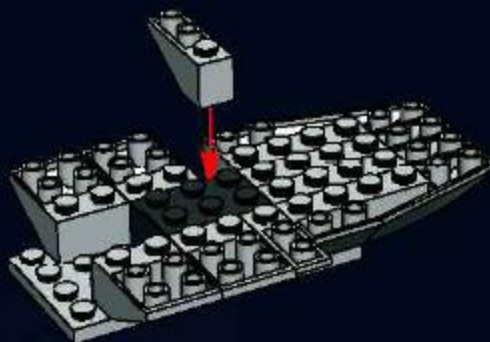

1x



1x

4

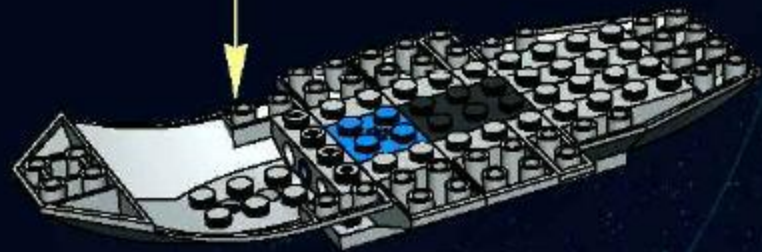

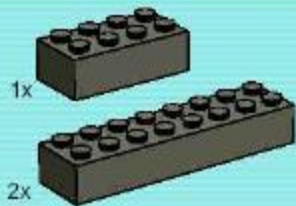

5

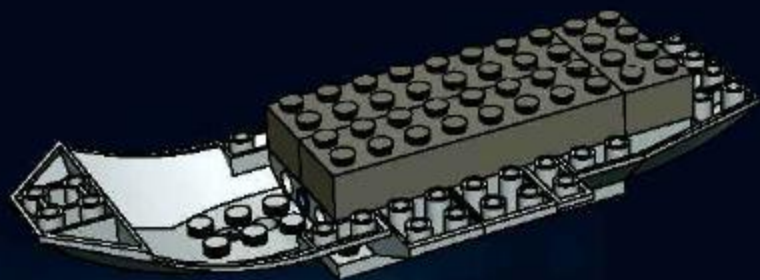



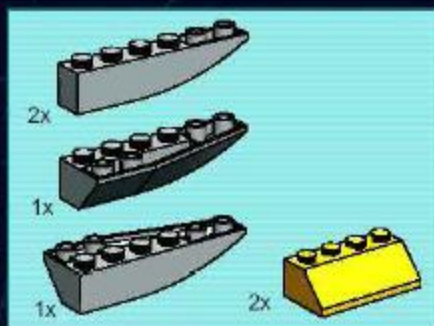

6

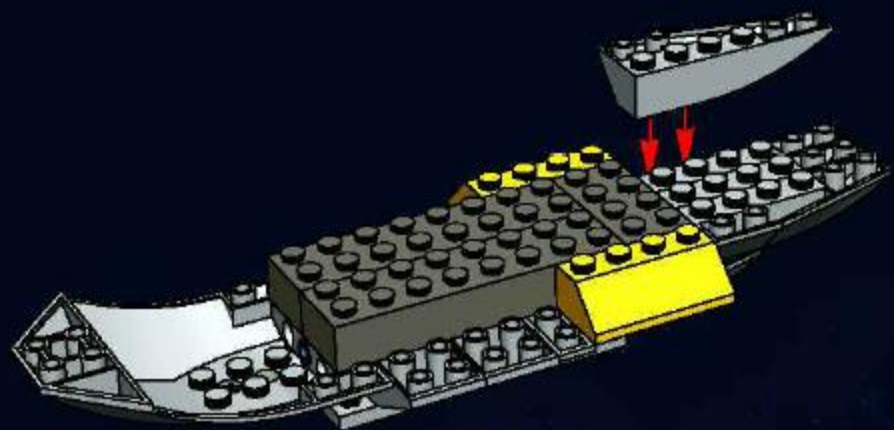

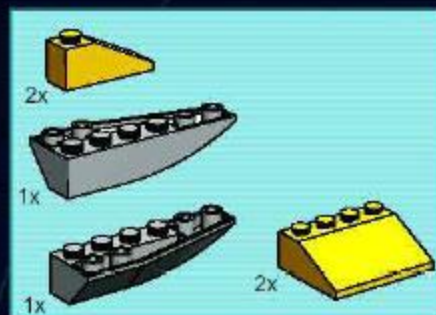

7

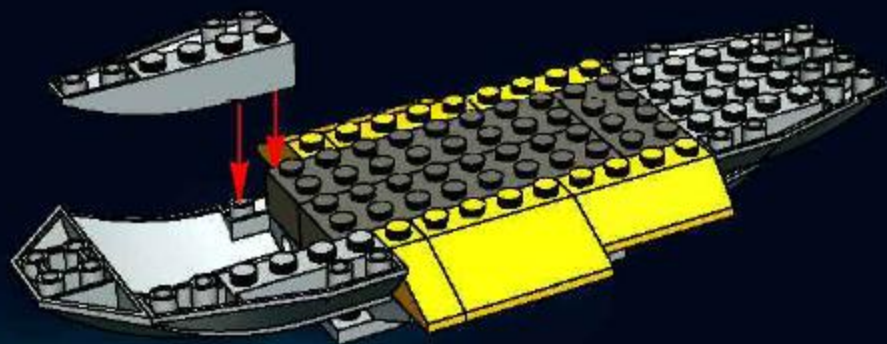

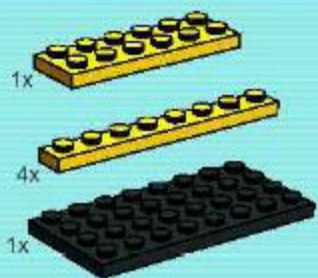

8

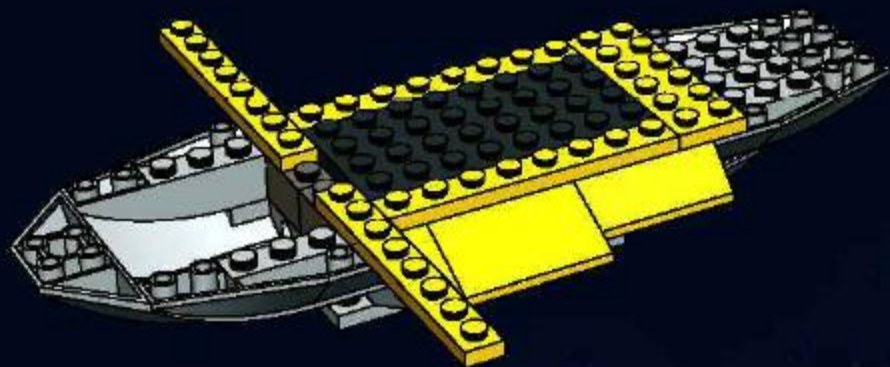

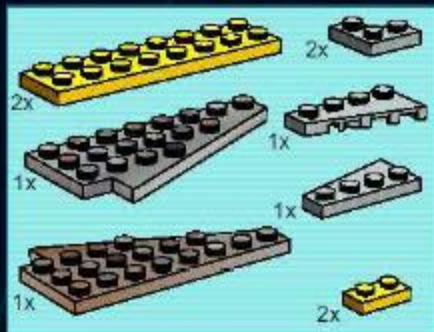

9

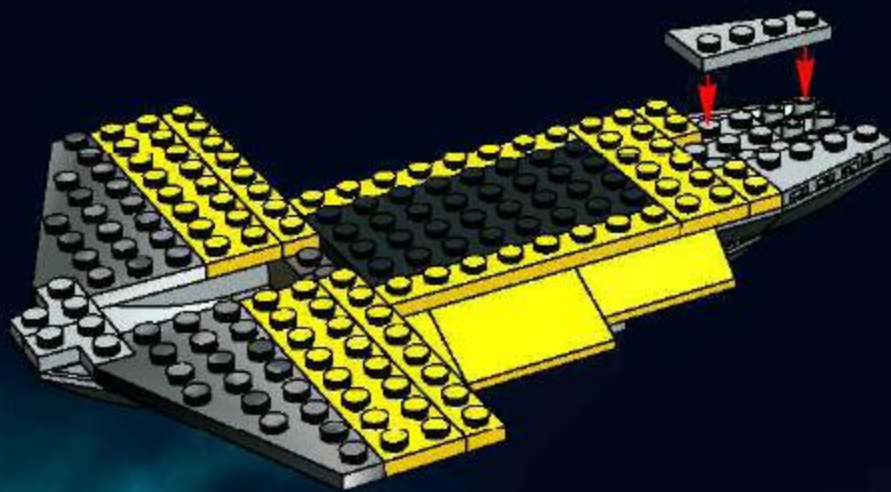





2x



2x

10

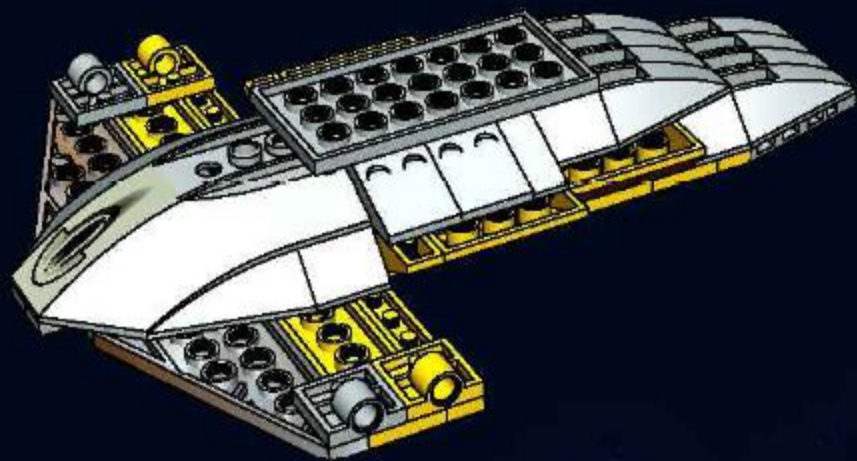

2x



2x



1 1

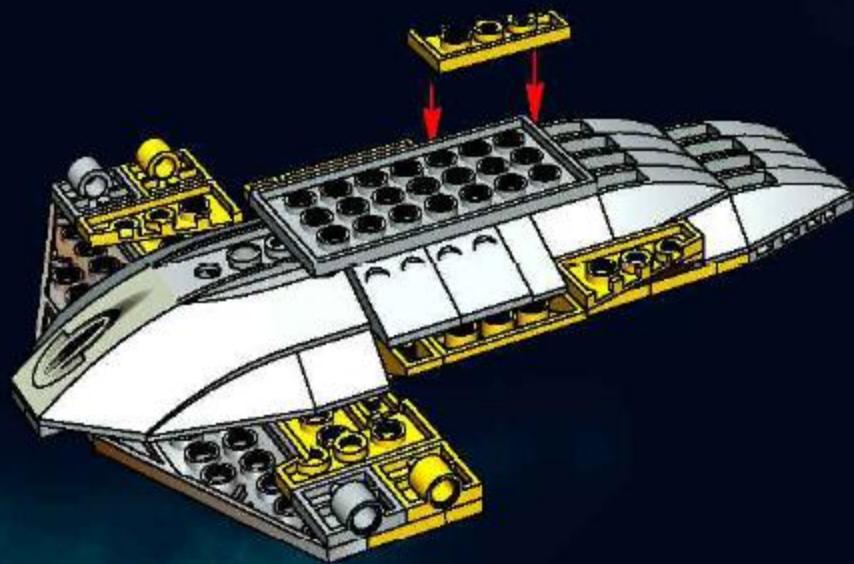



12

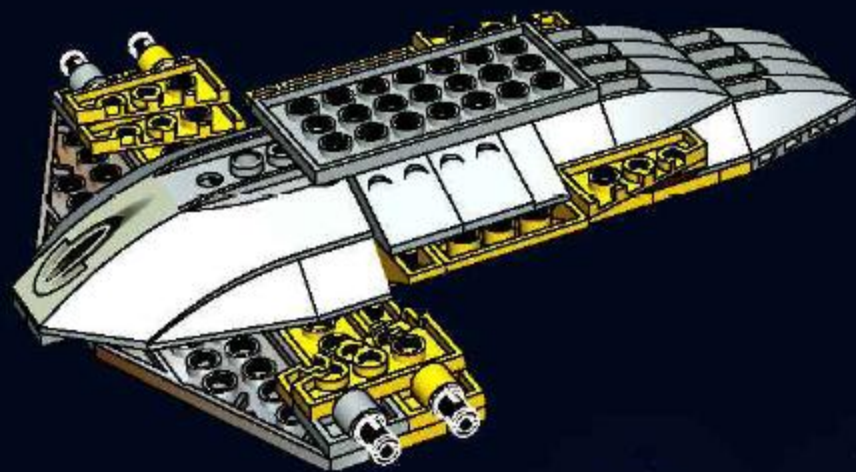

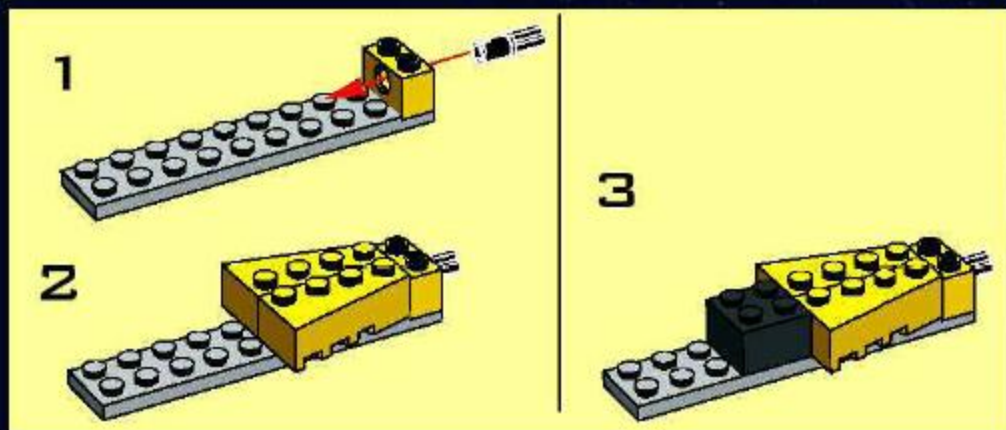
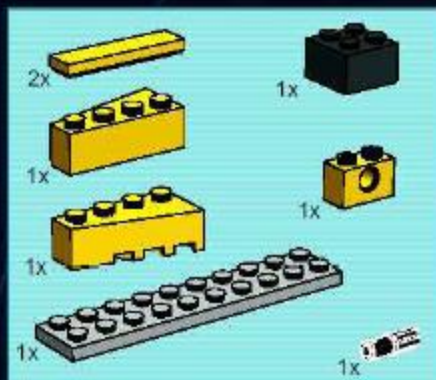

13

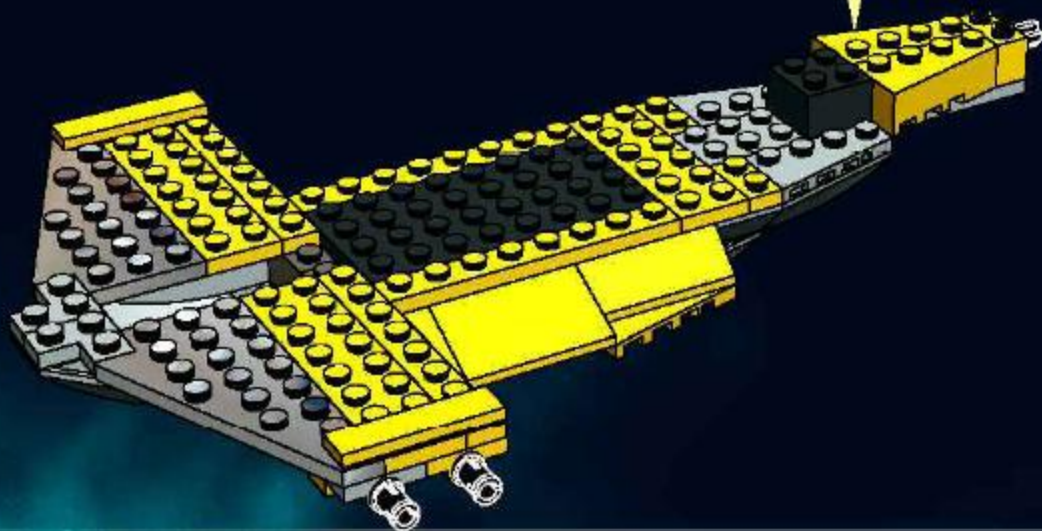



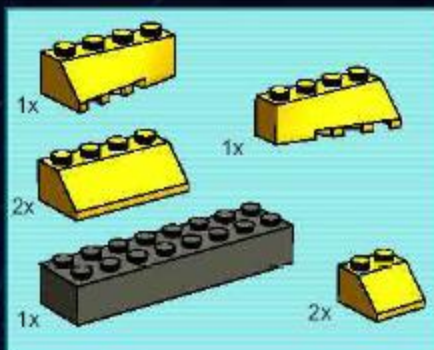

14

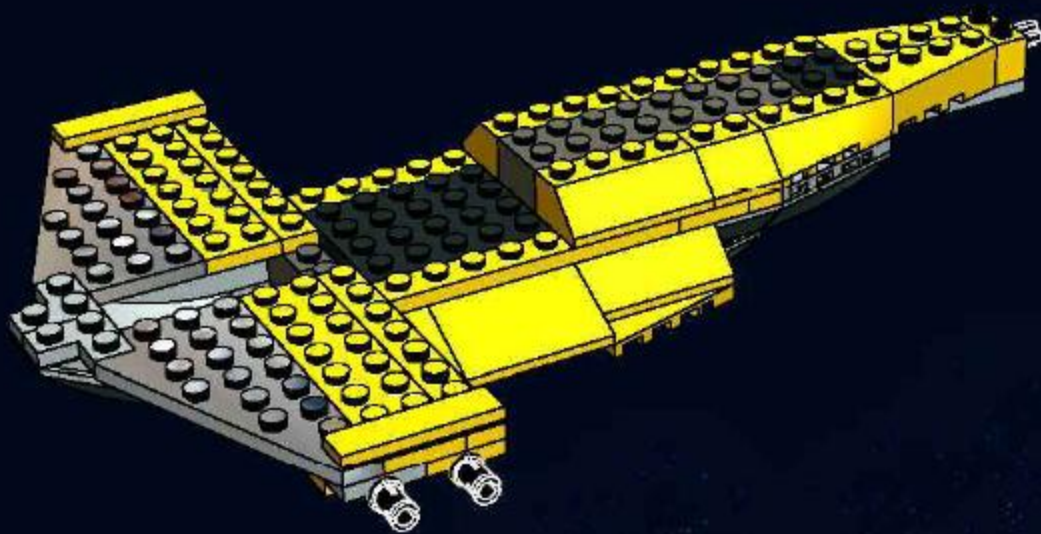

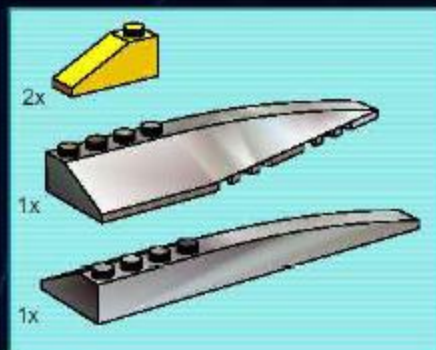

15

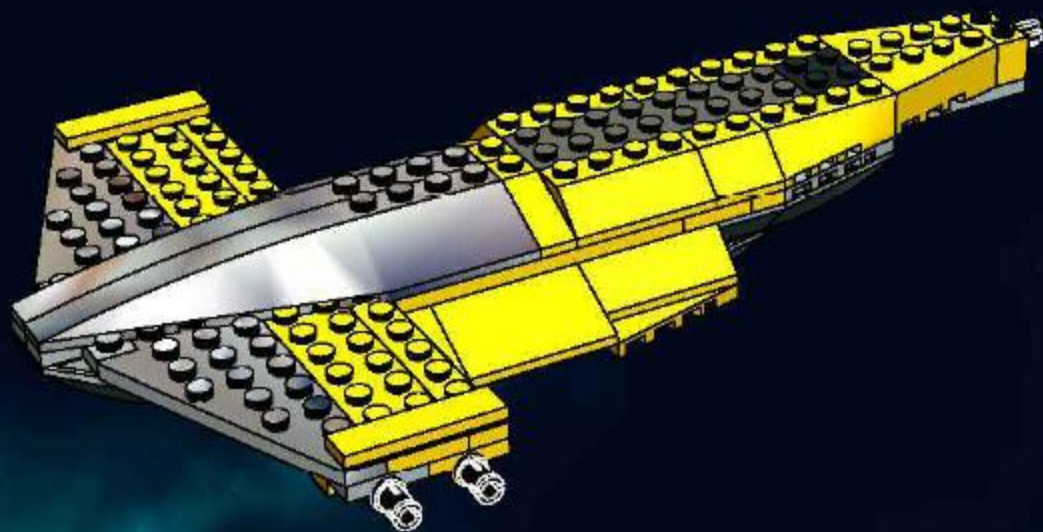

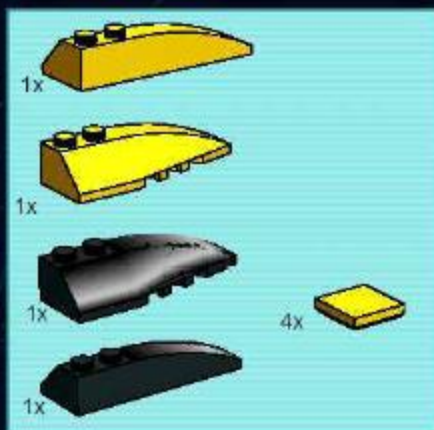

16

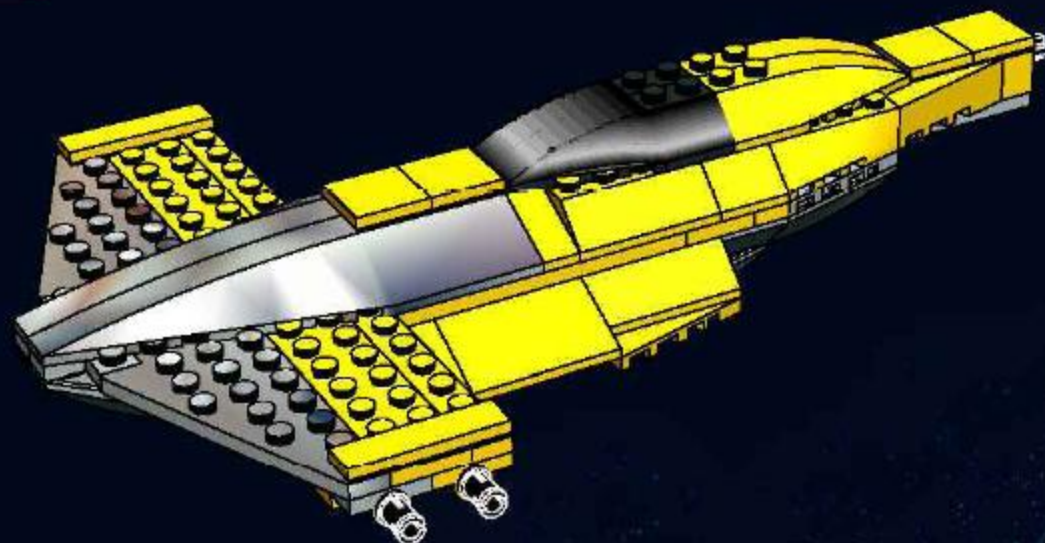



1x



1x

17

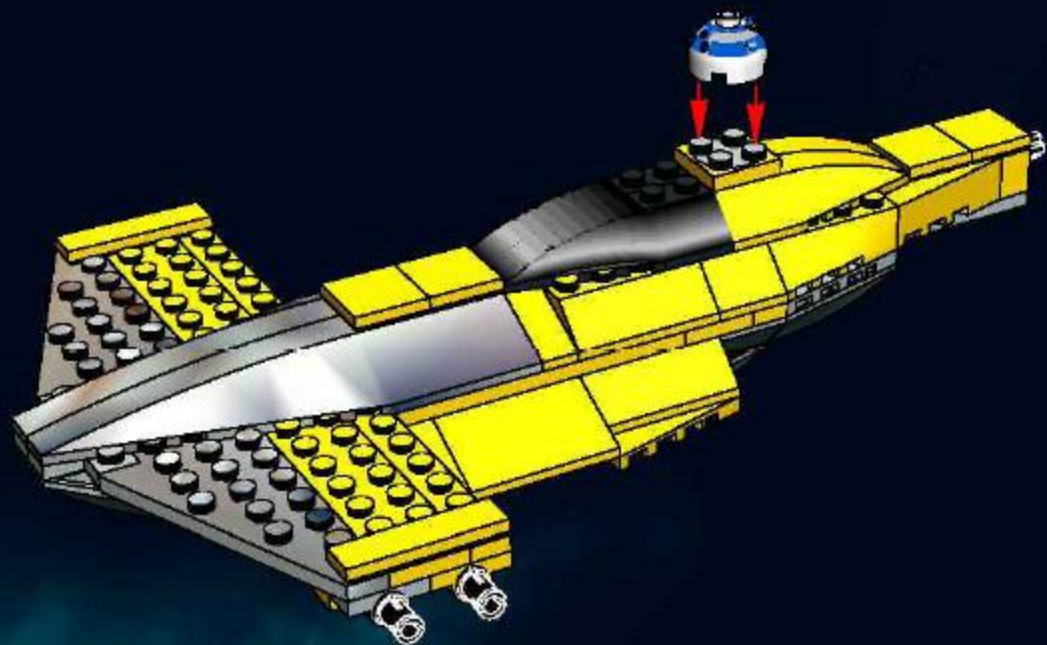





18

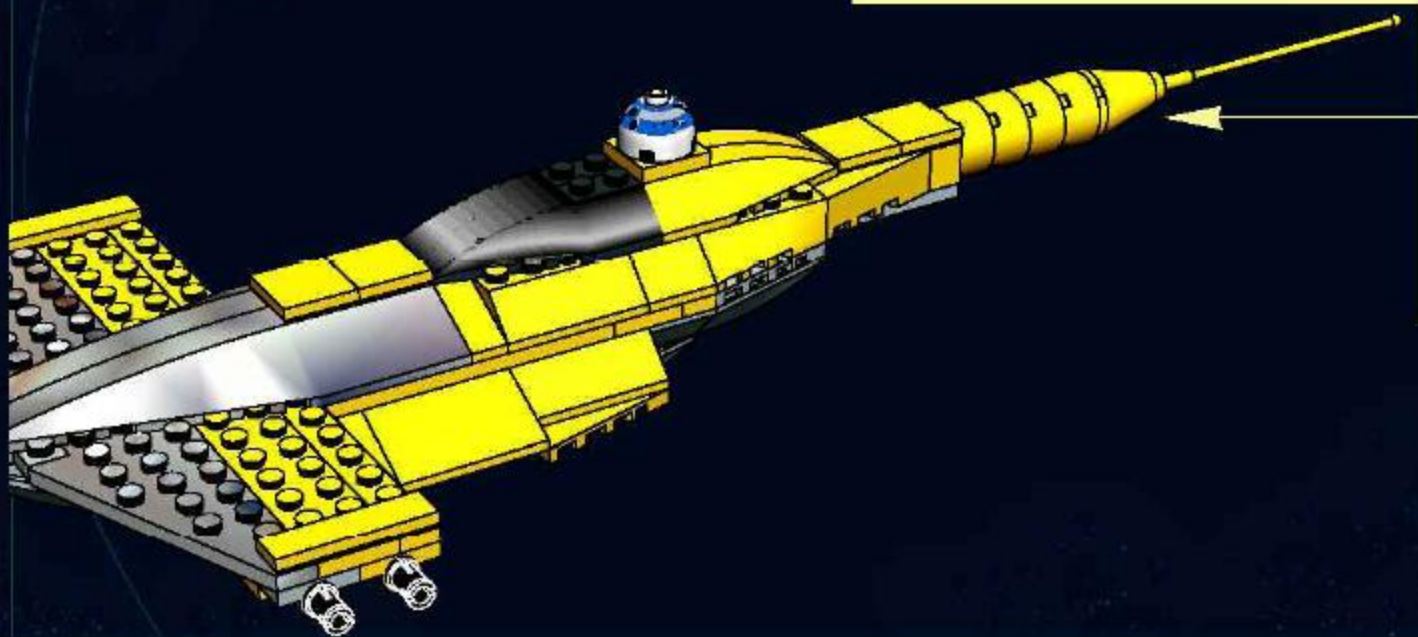
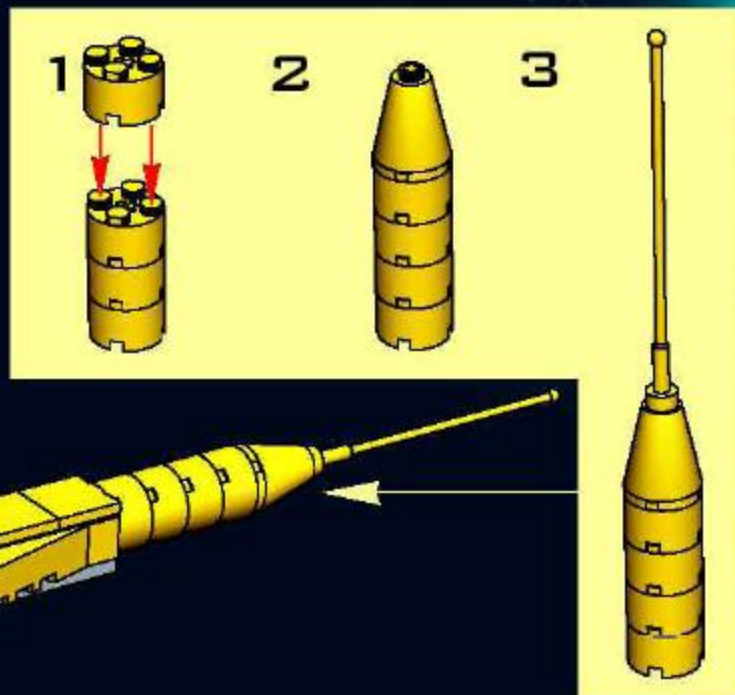

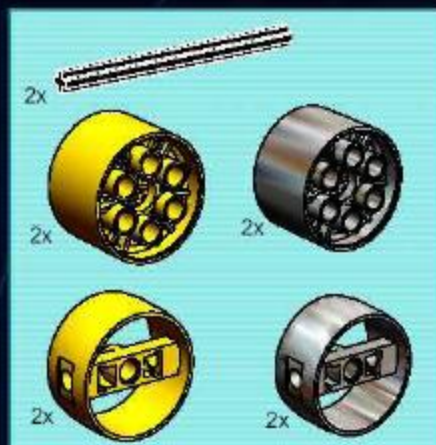

19



1



2



3



4



2x

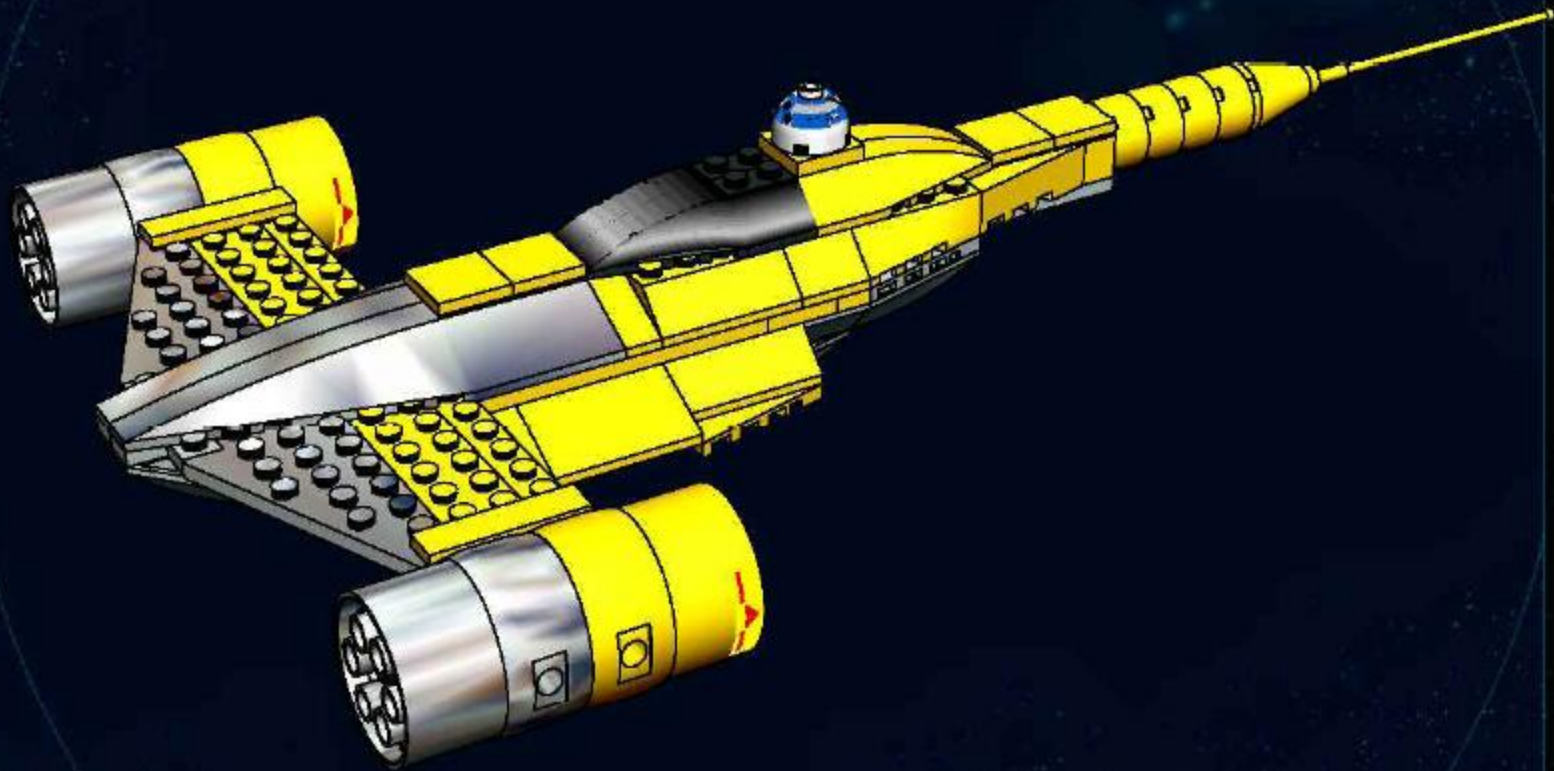



20

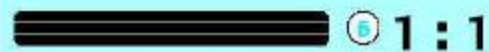
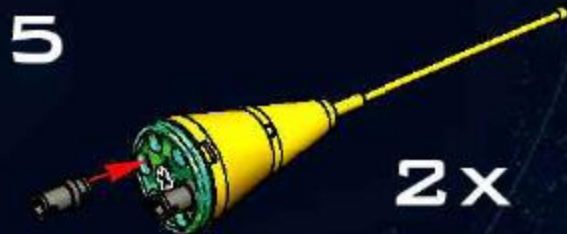



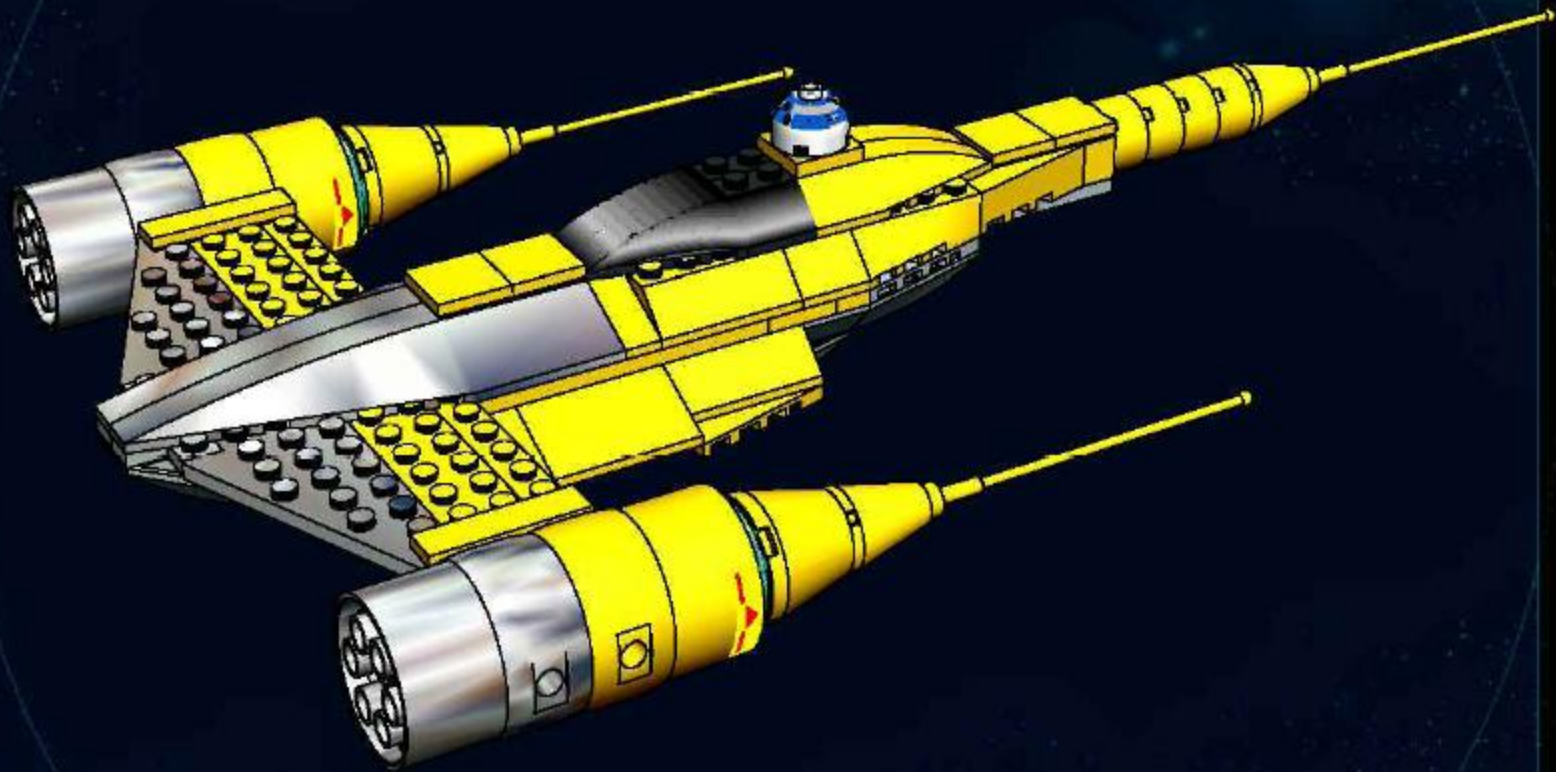



21

1



2



3



4

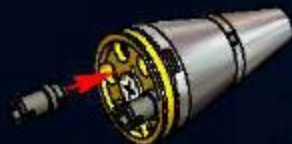

2x







1

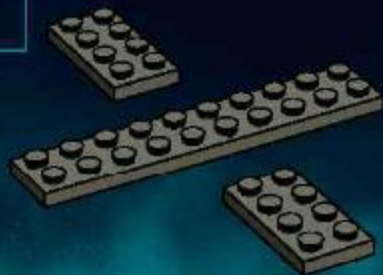

2

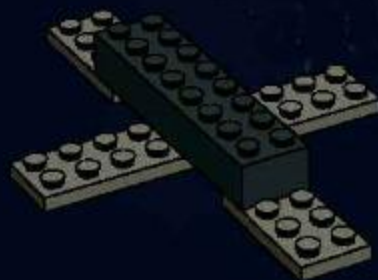

3

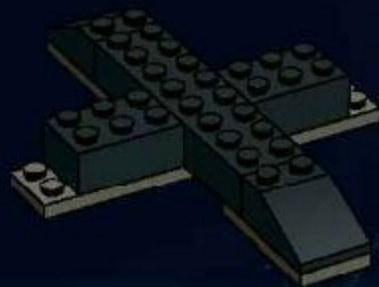



2x



2x



4



2x

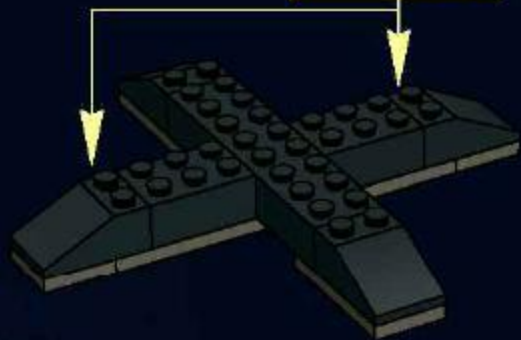

3x



1x



2x



5





1x



1x

6



2x



1x

7

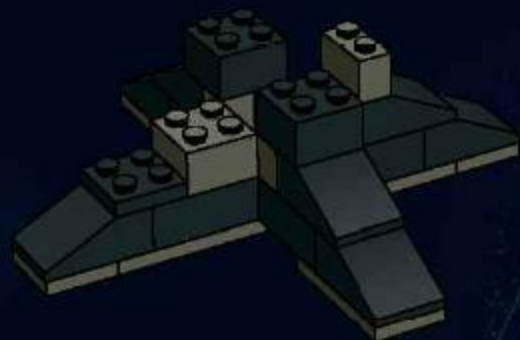

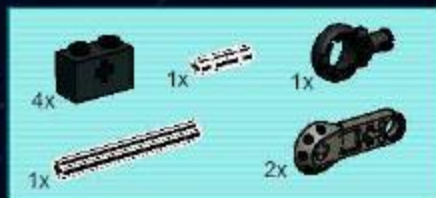

8

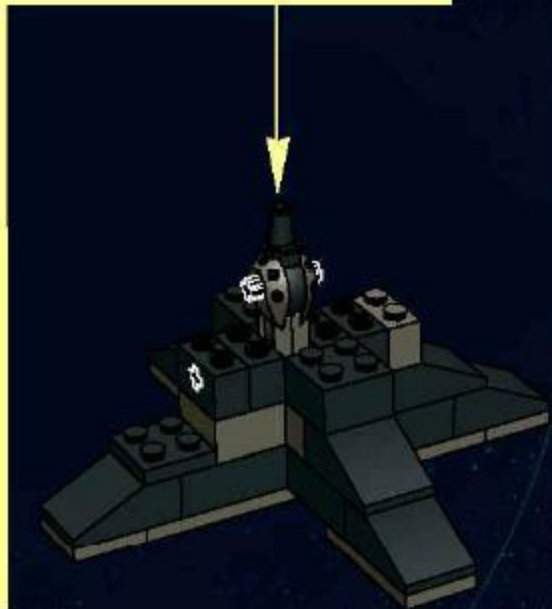
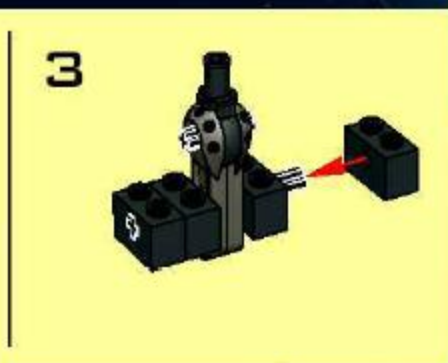
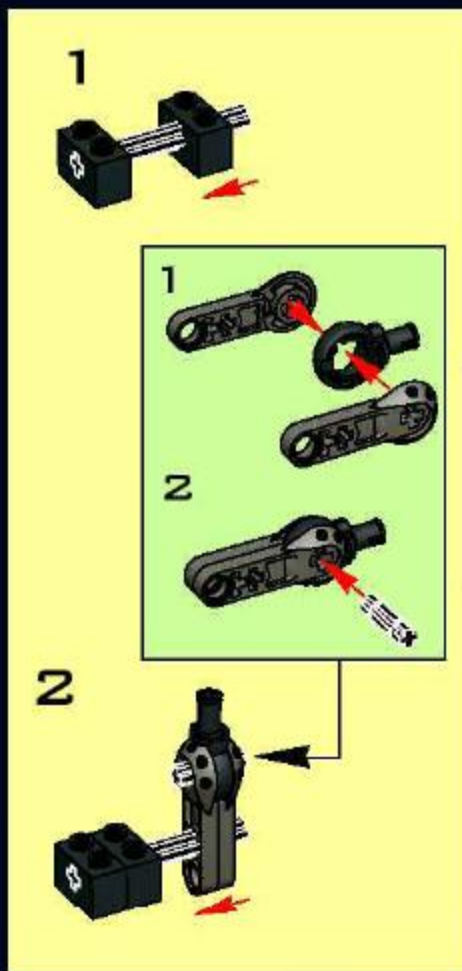



9

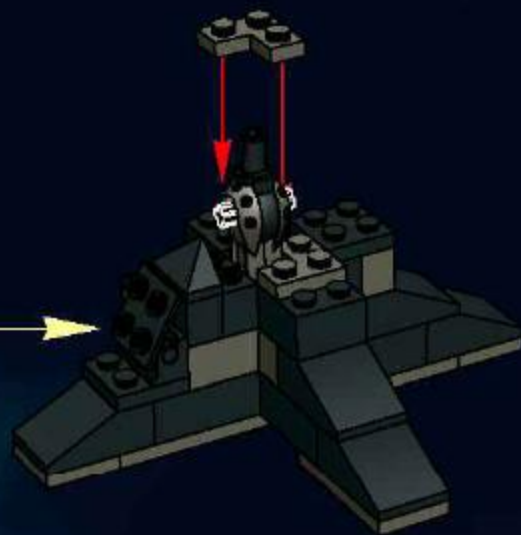
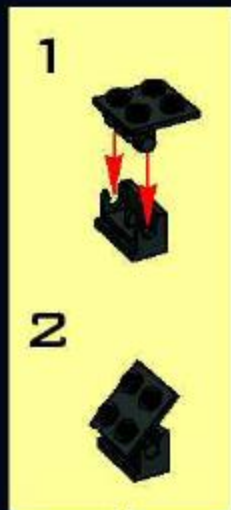





10

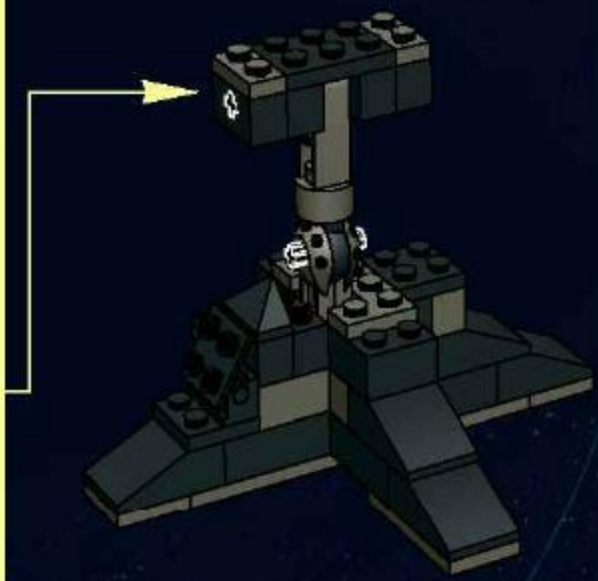
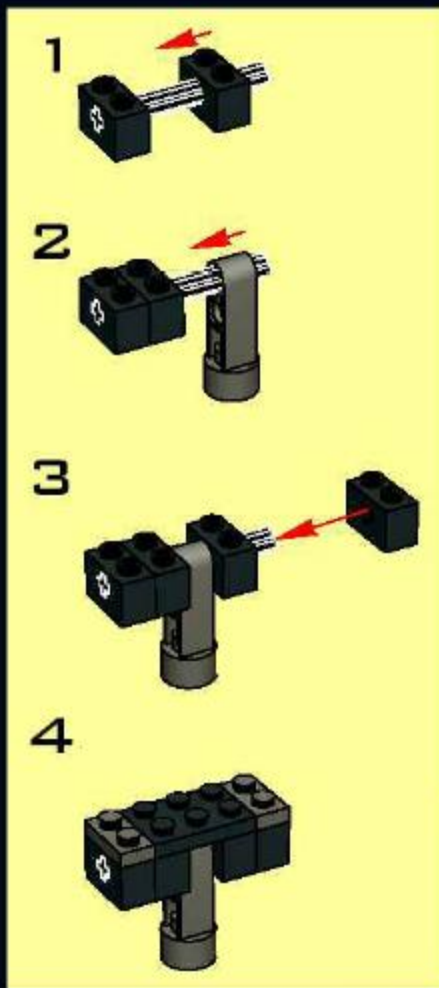



1 1

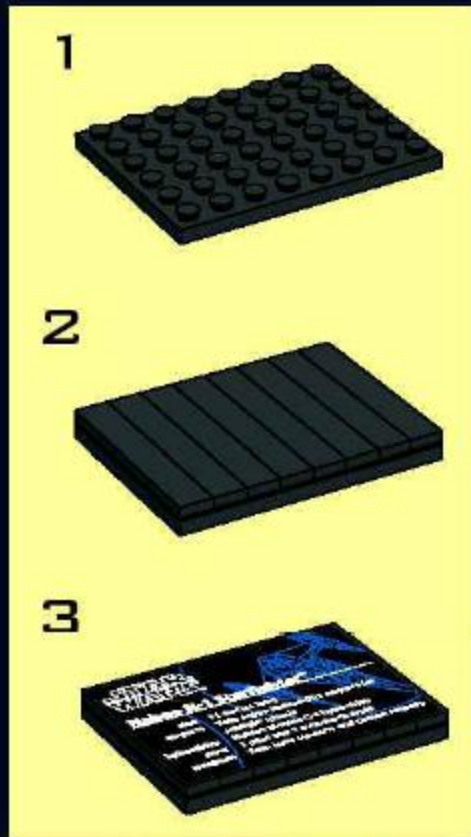



LEGO and the LEGO logo are trademarks of the LEGO Group.  
©2002 The LEGO Group.

