



ALIEN CONQUEST

7051



1

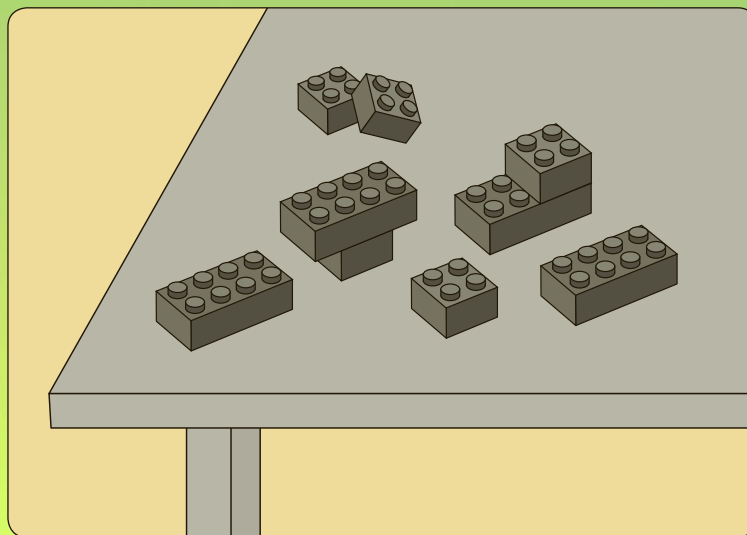
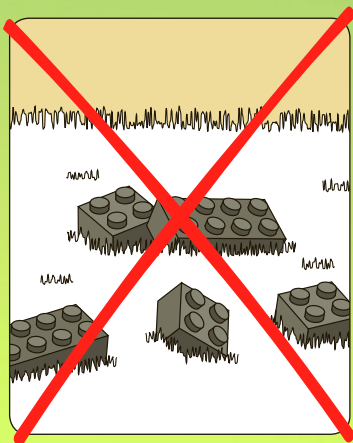

2

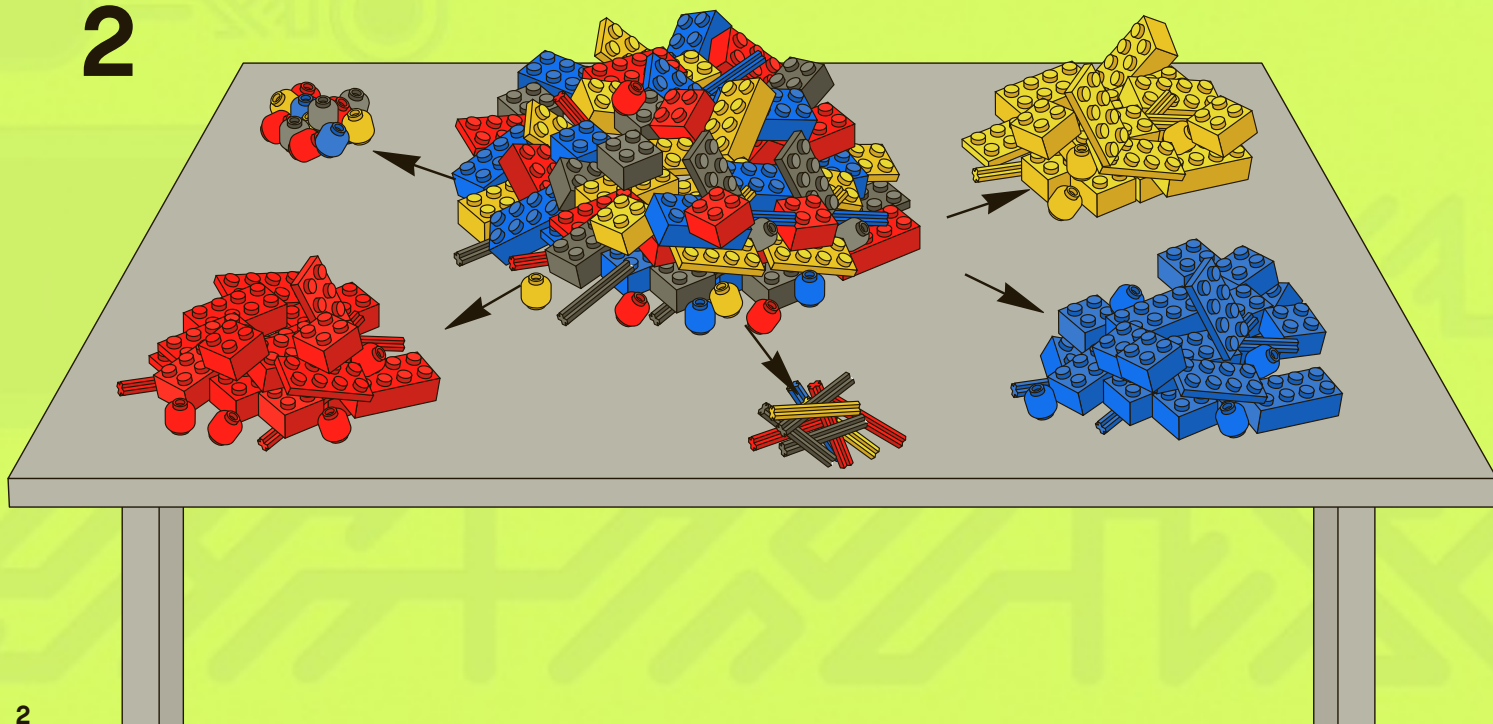

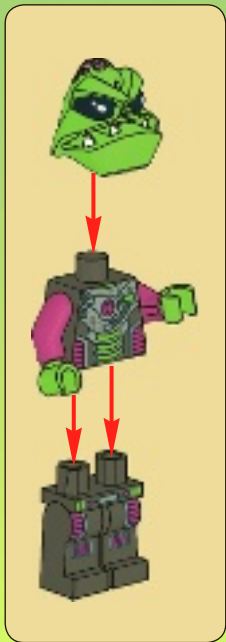

+



=



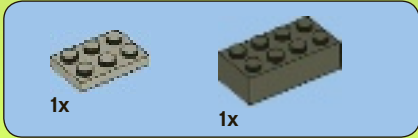

1

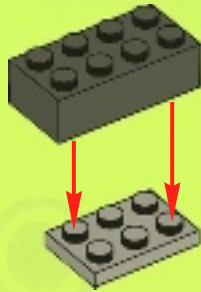

2

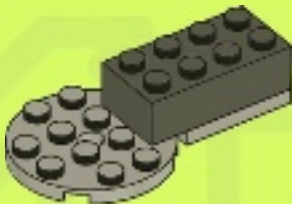

3

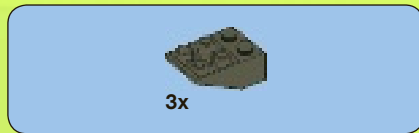
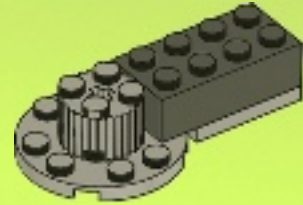

4





5

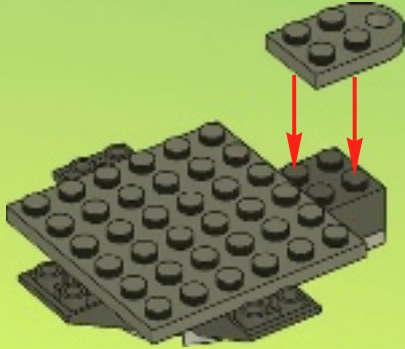

6

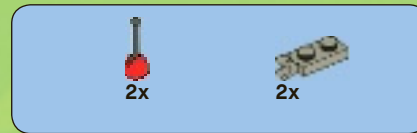

7

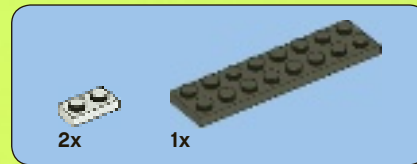

8





9

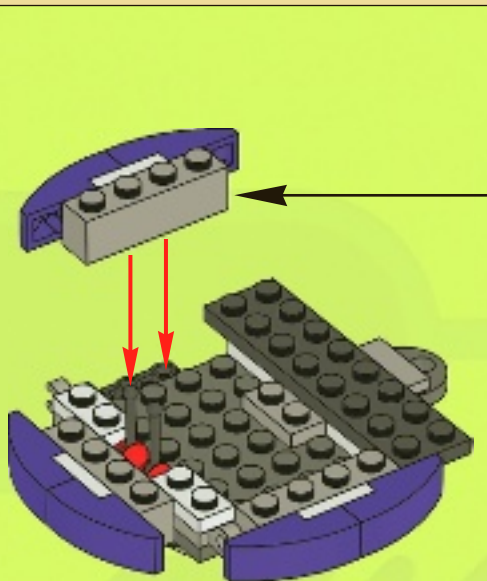



3x

10

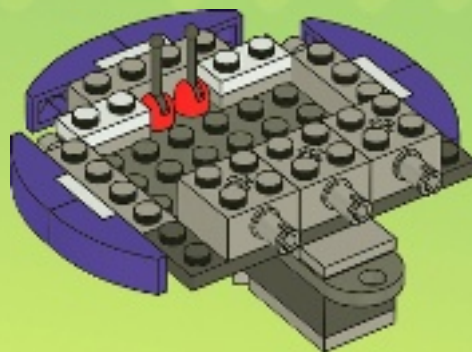

2x



1x

11

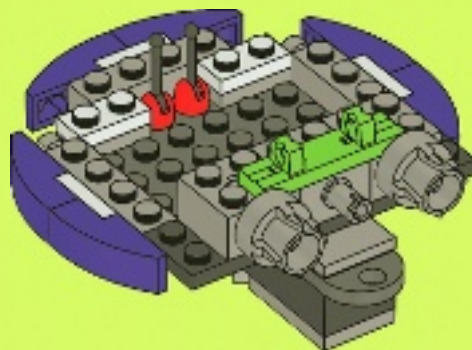

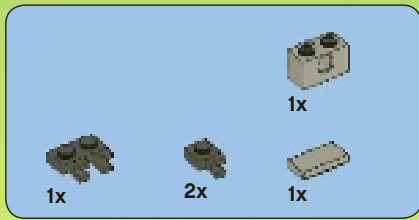

12

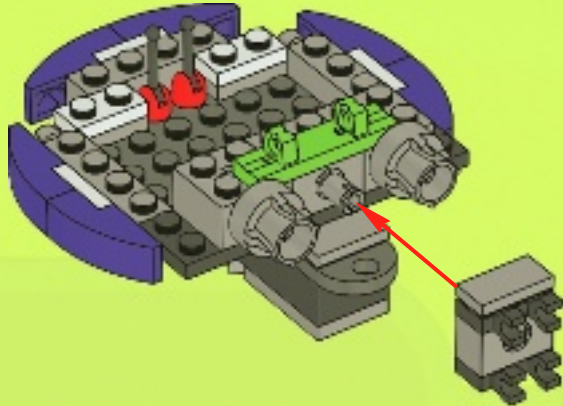
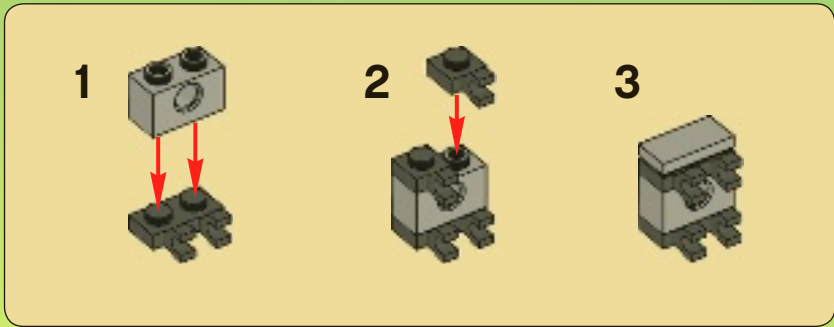



13

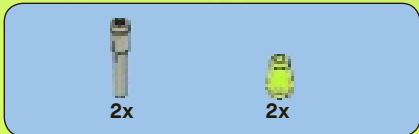

14

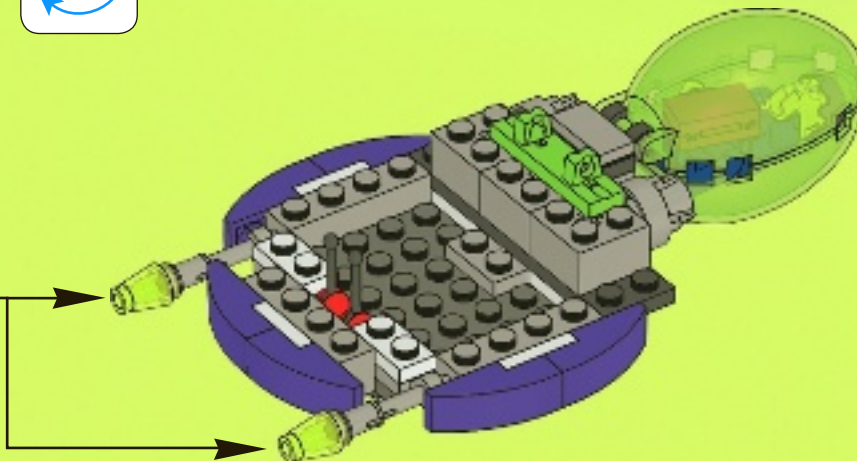
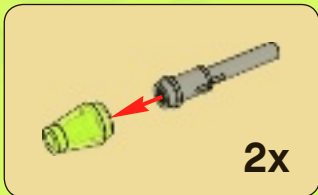

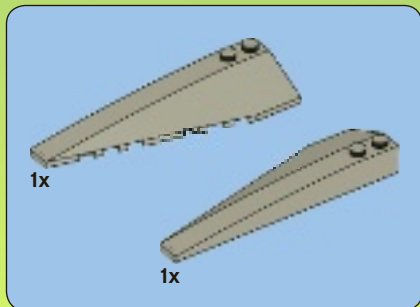

15

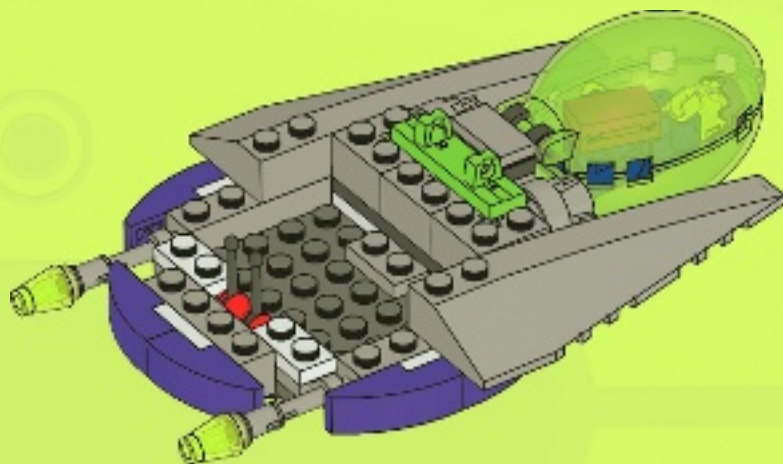



16

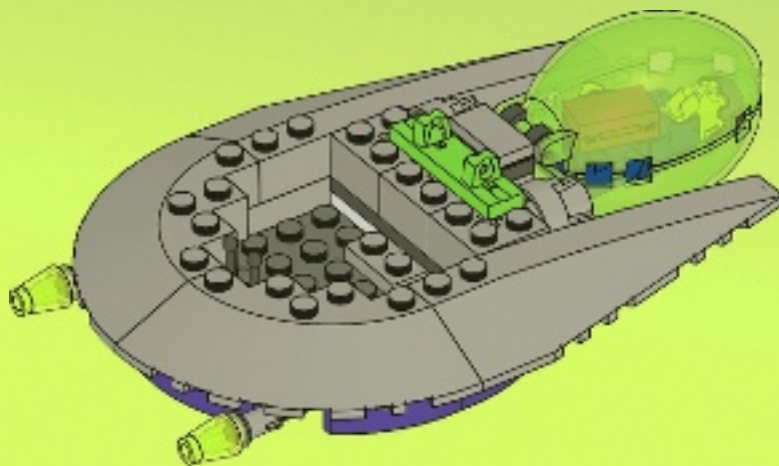



3x



2x

17

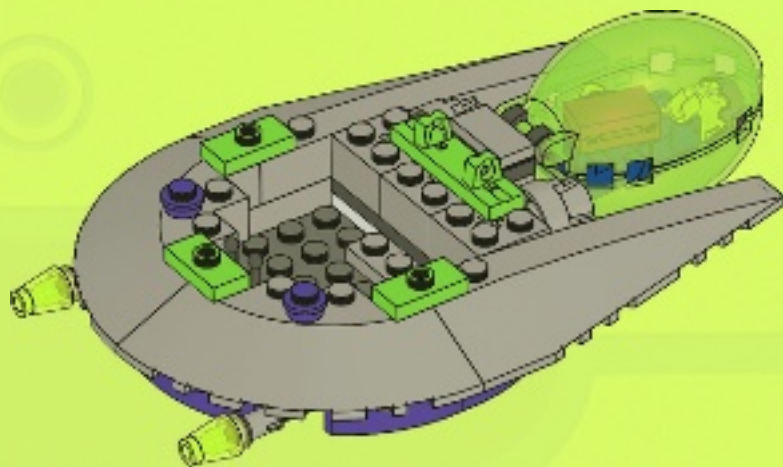



18

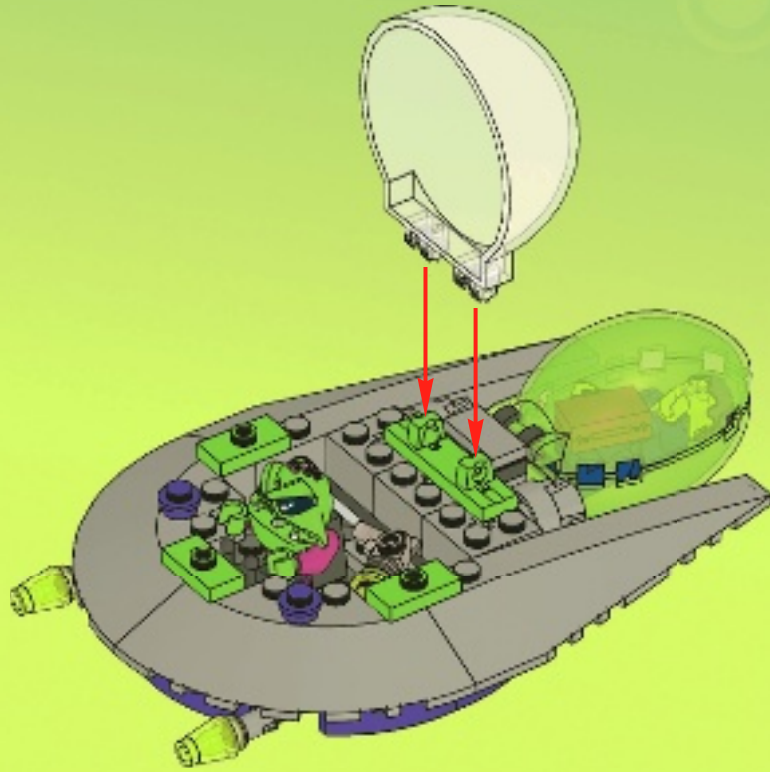

19

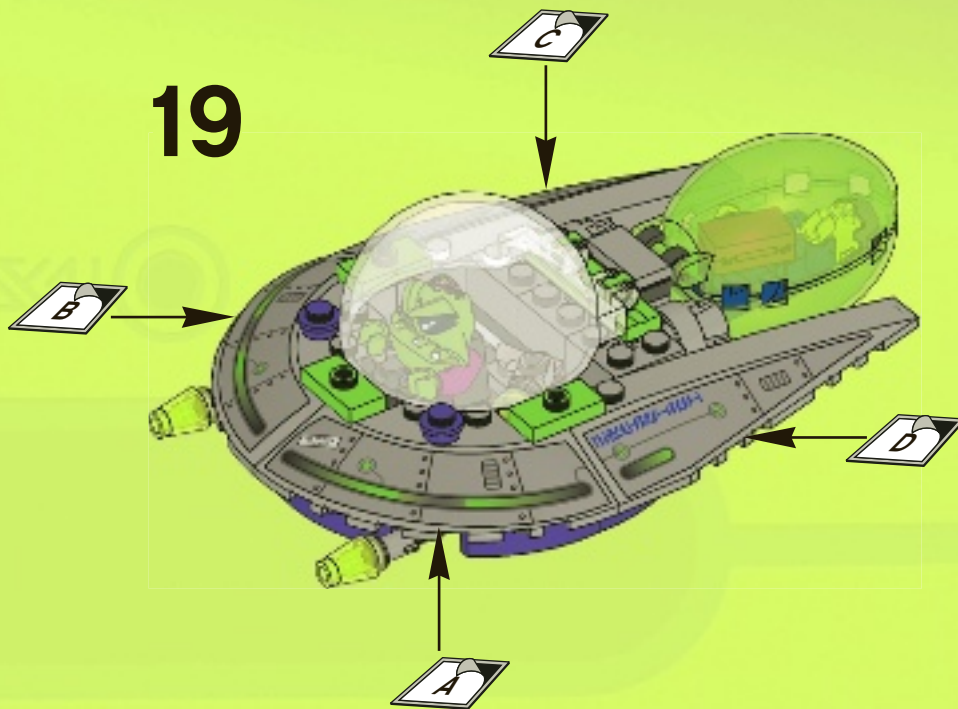



1

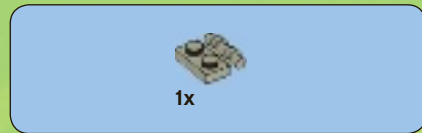

2



3

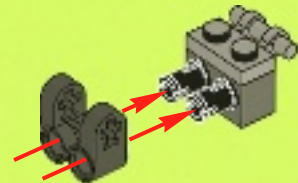



1x



1x

4

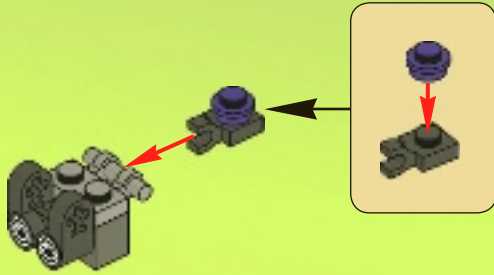

1x

5

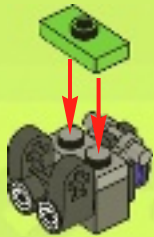

1x

6

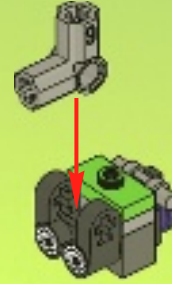

1x

7

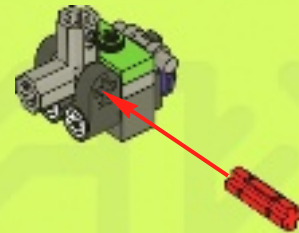



8

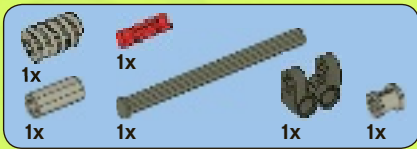

9

1



2

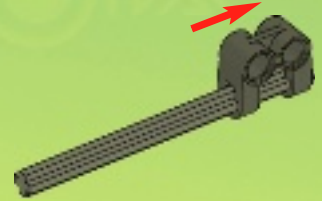

3

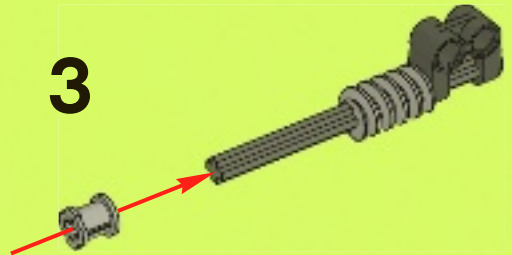

4

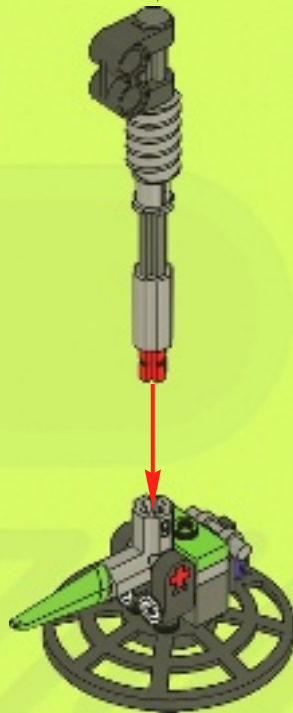
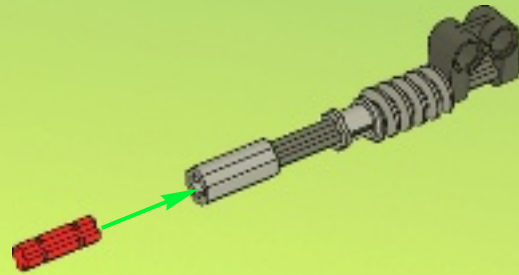

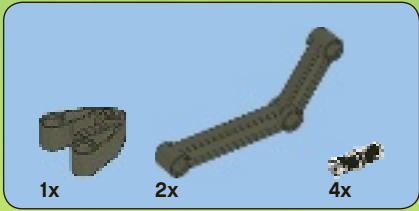

10

1



2

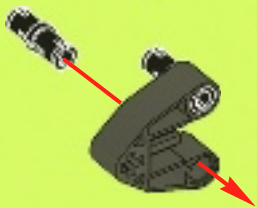

3

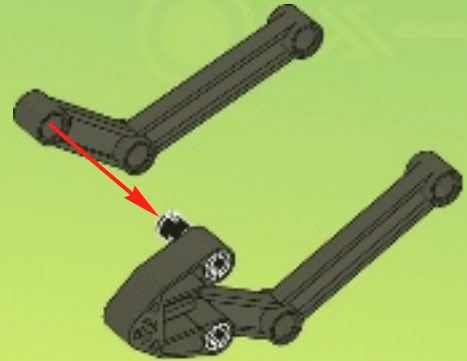

4

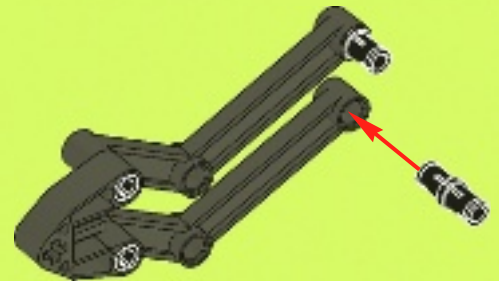

5

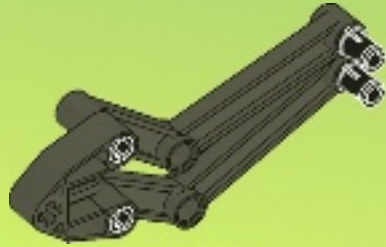

6

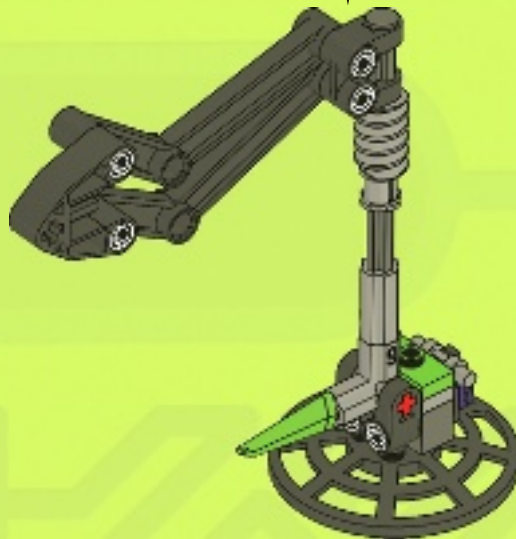

3x



1x

11

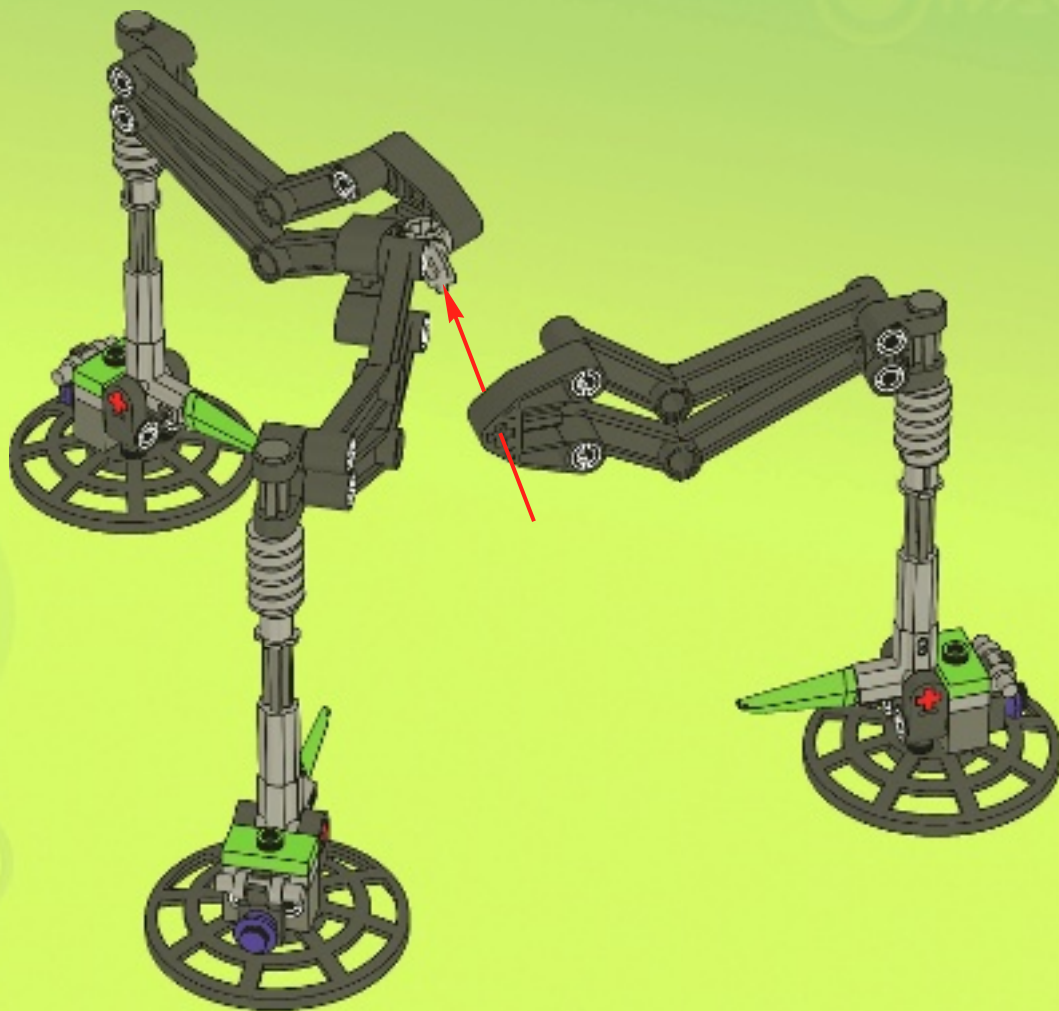

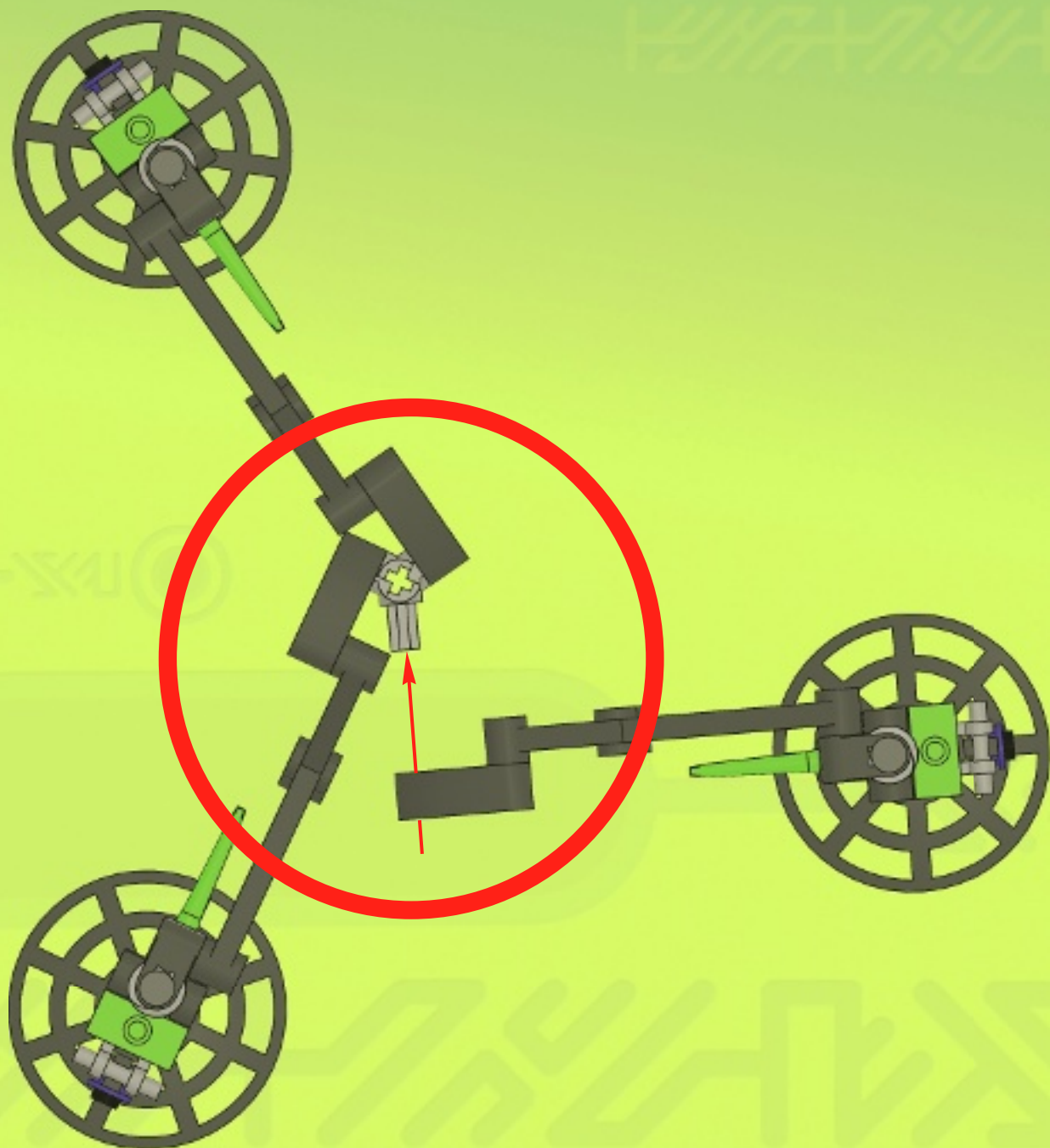

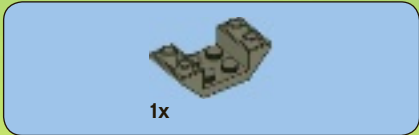

1

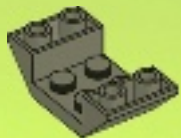

2

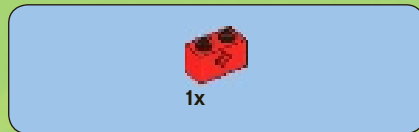
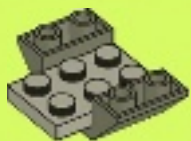

3

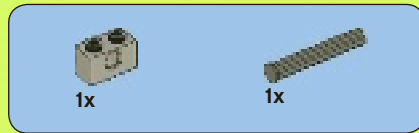

4

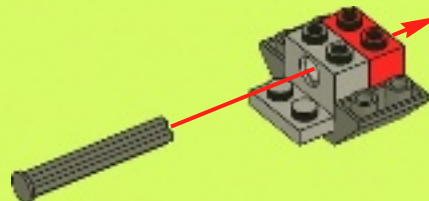



5

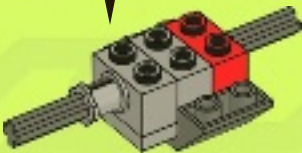
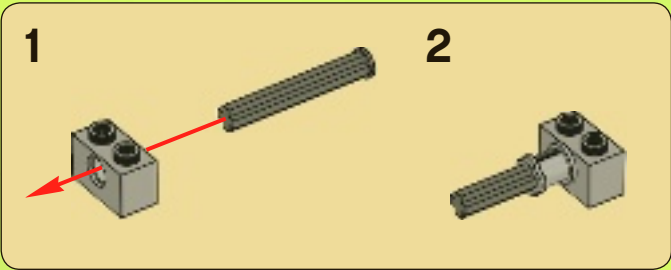

6

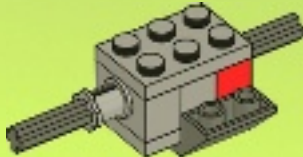

7

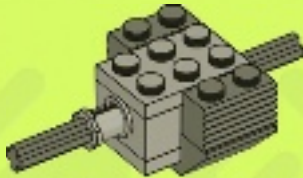



8

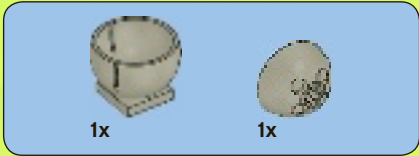
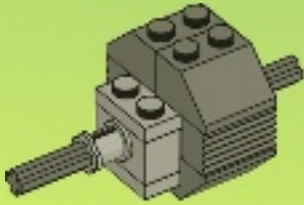

9

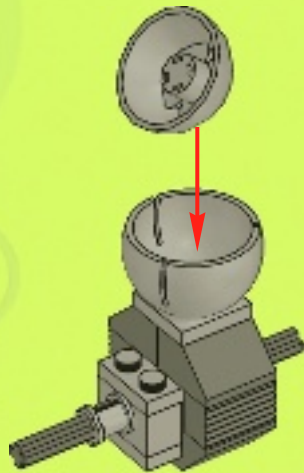

10

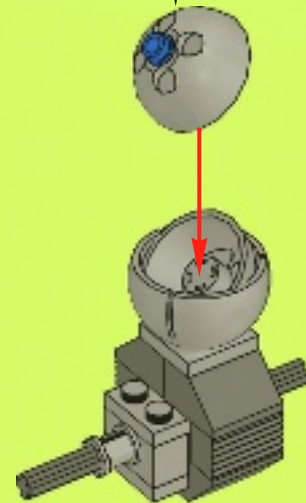
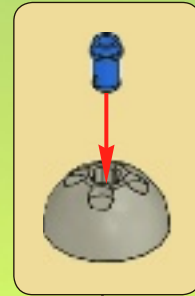

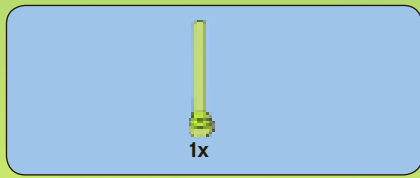

11

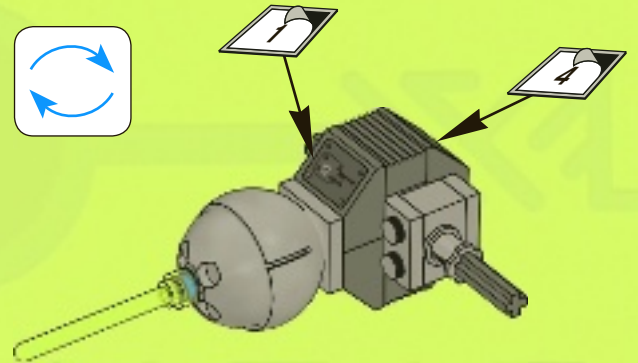
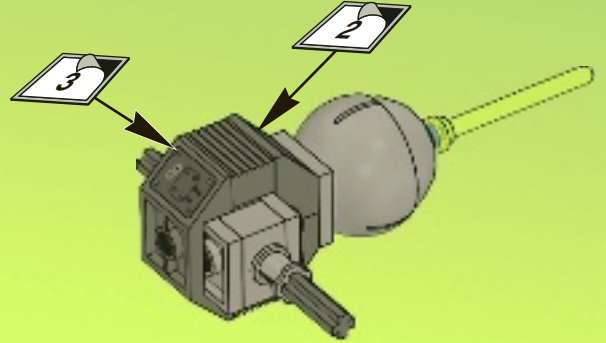
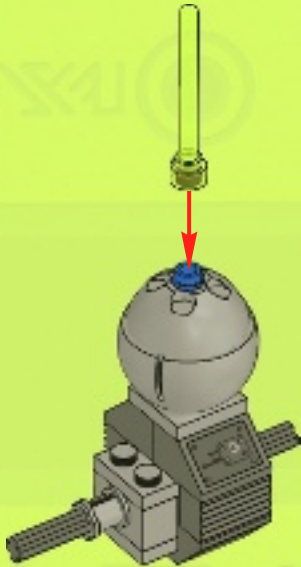

12





1x

13

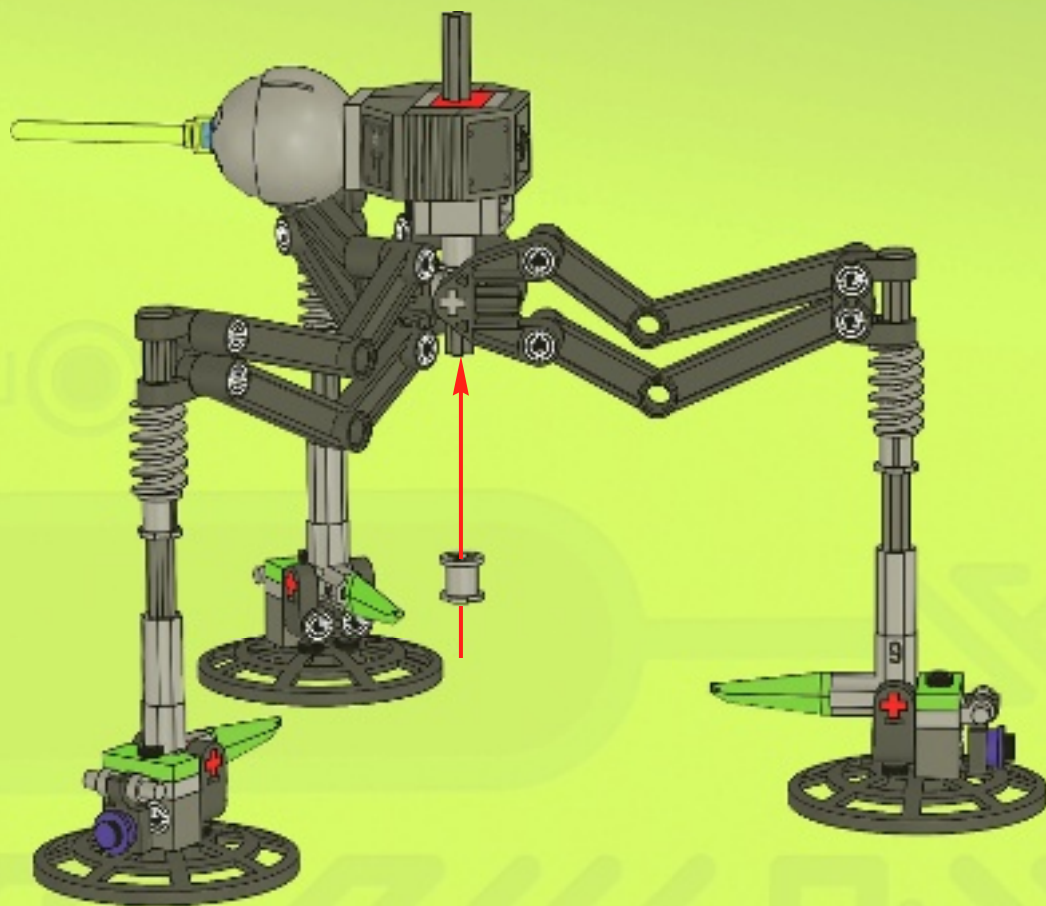

14

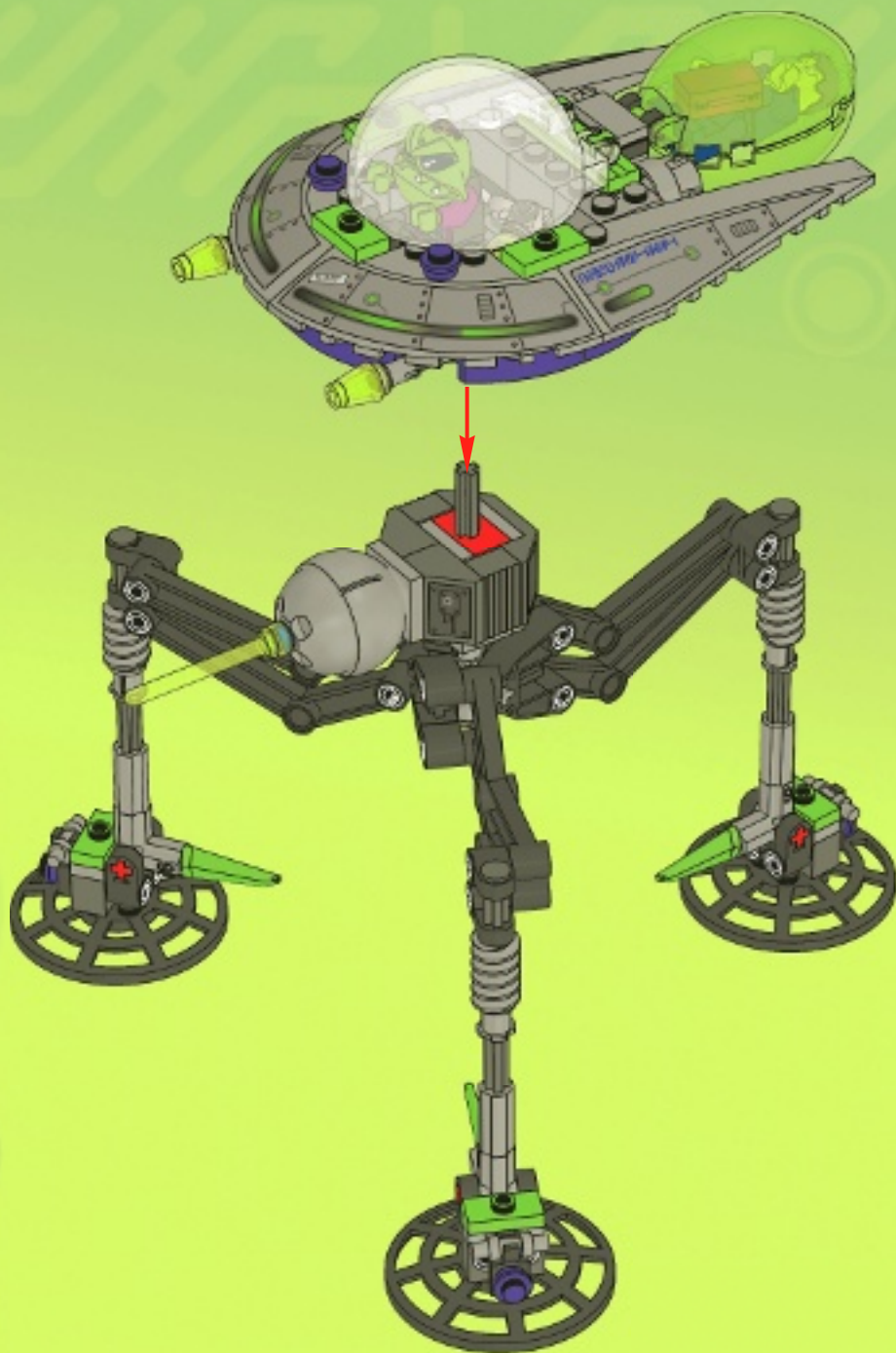



6x
4578772

6x
4162857

2x
4622336

2x
4520320

2x
4560177

1x
4211235

5x
4566522

3x
4497946

5x
4211622

3x
4499858

1x
4143005

1x
4513987

18x
4121715

1x
4505088

3x
4512360

1x
4624369

2x
4567334

2x
74335

7x
302301

1x
4505087

1x
4502595

1x
3005749

6x
4142865

6x
4500069

2x
4211414

2x
4278756

1x
4114011

1x
300126

1x
4622571

4x
4211396

3x
4211510

2x
4563482

1x
4625828

6x
4539296

3x
4616843

3x
4211632

2x
4210636

1x
4625812

1x
4623600

3x
374726

3x
4211529

2x
4535738

3x
4210762

1x
4162916

1x
4624618

1x
303426

3x
4211636

1x
4515351

2x
4211054

1x
4623722

1x
4646511

5x
4517925

1x
4650645

1x
4211801

1x
4211076

1x
4623948

1x
4526110

1x
4556158

3x
4211440

2x
4529550

1x
4211134

1x
4225733

3x
4509865

3x
4509886

Customer Service
Kundenservice
Service Consommateurs
Servicio Al Consumidor

www.lego.com/service or dial

 : 00800 5346 5555
: 1-800-422-5346



ALIEN CONQUEST



ALIENCONQUEST.LEGO.COM



ALIEN CONQUEST



ALIENCONQUEST.LEGO.COM



The LEGO logo is positioned in the top left corner, featuring the word "LEGO" in white, bold, sans-serif font with a black outline, set against a red square background.

ALIEN CONQUEST

ATTACK • ALIEN ATTACK



ALIENCONQUEST.LEGO.COM



www.LEGOclub.com



LEGO® Club Email

LEGO club™

FREE! GRATIS! GRATUIT!



LEGO® Club Magazine

SIGN UP ONLINE!

www.LEGOclub.com



00800 5346 5555*



1-866-534-6258 • 1-877-518-5346

US & Canada only

Canada seulement

* Freephone. Mobile charges may apply.
* Numéro sans frais. Des frais peuvent s'appliquer avec les téléphones cellulaires.
* Gebührenfrei, Kosten für Anrufe aus Mobilfunknetzen können abweichen.
* Gratis telefonnummer vanaf vaste lijn.
* Det er et gratis nummer, når du ringer fra fasttelefon.
* Det är gratis, när du ringer från en fast telefon.
* Numéro sans frais. Des frais peuvent s'appliquer avec les téléphones portables.



WIN!

Go to www.LEGOsurvey.com/product to fill out a survey for a chance to win a cool LEGO® Product. No purchase necessary. Open to all residents where not prohibited.

 www.LEGO.com



www.LEGOsurvey.com/product

GEWINNE! WIN!

Nimm an der Umfrage auf www.LEGOsurvey.com/product teil und hab die Chance ein cooles LEGO® Produkt zu gewinnen!
Die Teilnahme am Gewinnspiel führt zu keinerlei Kaufverpflichtungen. Teilnahme in allen nicht ausgeschlossenen Ländern möglich.

Ga naar www.LEGOsurvey.com/product, vul een enquêteformulier in en maak kans op een cool LEGO® product.
Geen aankoopverplichting. Iedereen mag deelnemen, uitgezonderd ingezetenden van landen waar een enquêteverbod geldt.

GAGNE! 当てよう!

Visite www.LEGOsurvey.com/product pour répondre à un questionnaire et avoir une chance de gagner un produit LEGO® très cool!
Aucune obligation d'achat. Ouvert à tous les résidents des pays autorisés.

www.LEGOsurvey.com/product にアクセスして、アンケートにご記入ください。当選者にはレゴ®製品を差し上げます。
お買い上げの必要はありません。
禁止されていない限り、すべての皆様にご利用いただけます。