



NINJAGO

Masters of Spinjitzu



9456



VS





1

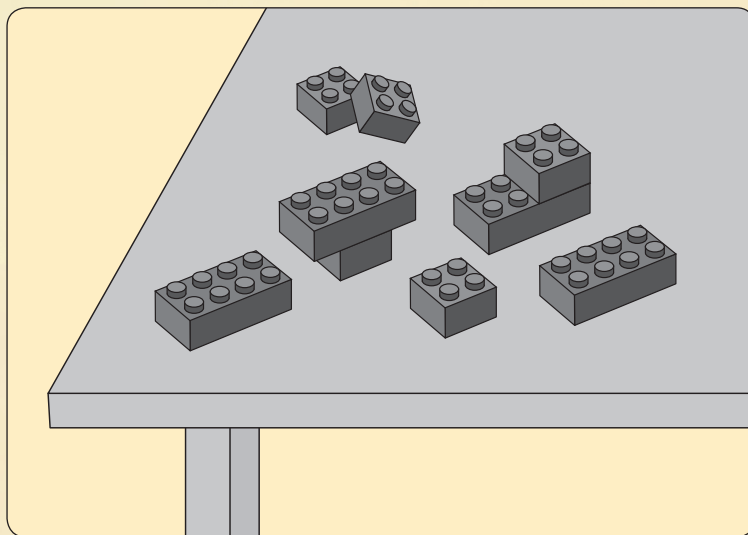
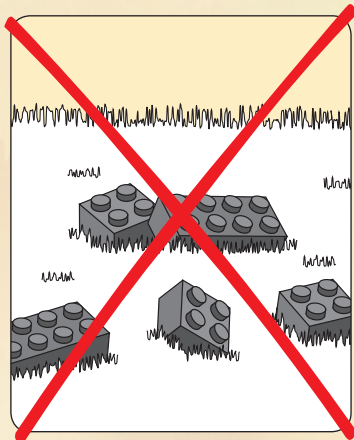

2



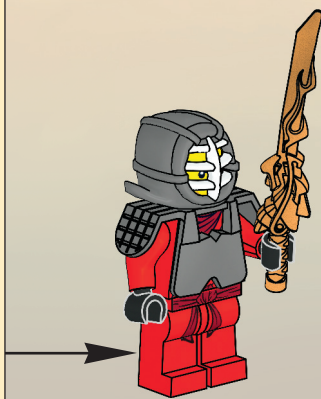
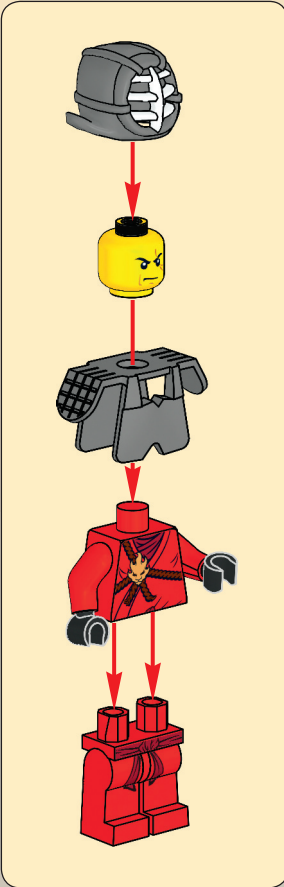
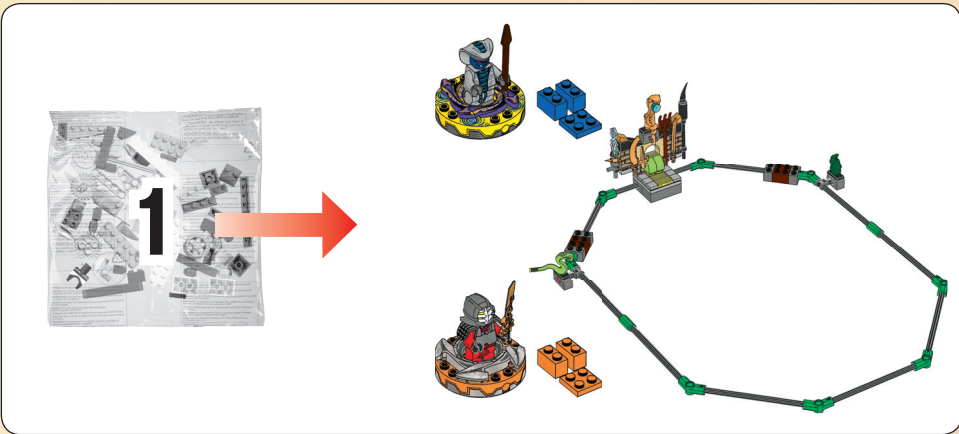

1



2

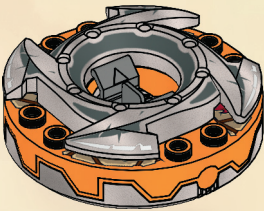

3

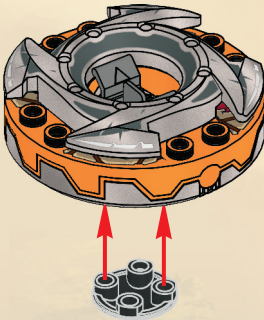

4

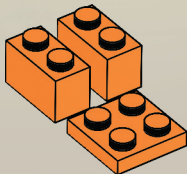

1

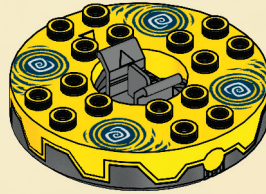

2



3

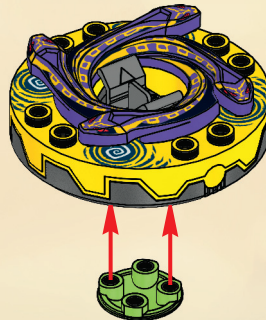

4

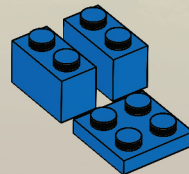

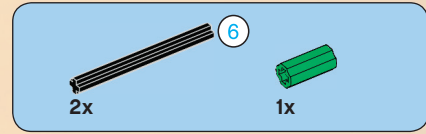
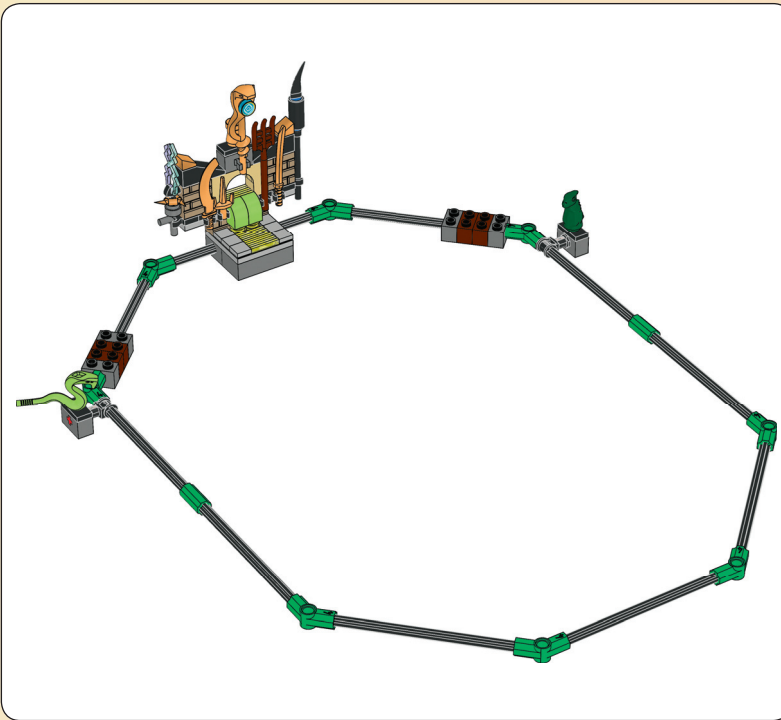

1

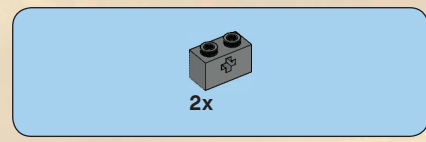
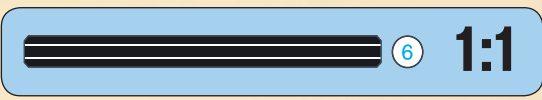
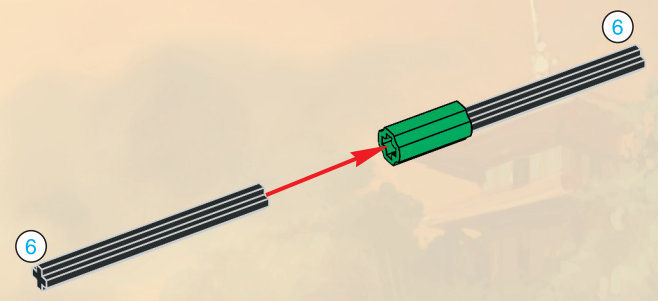

2

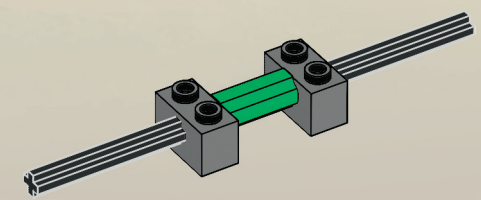

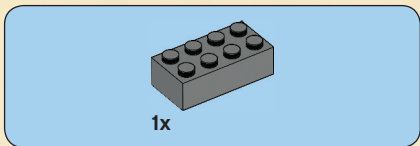

3

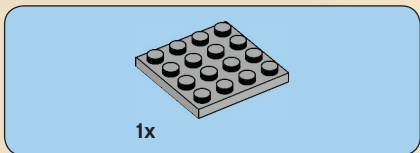
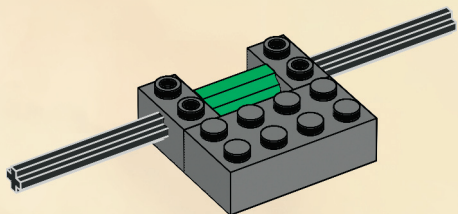

4

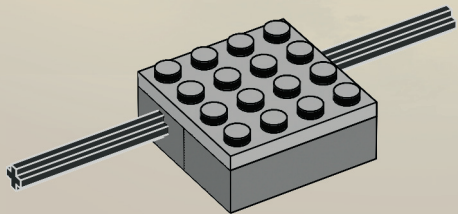

6



5

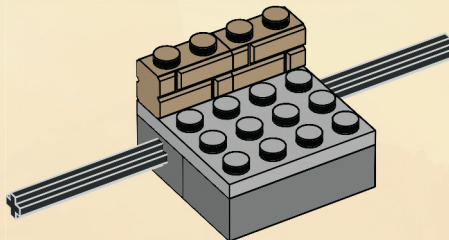

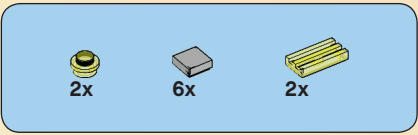

6

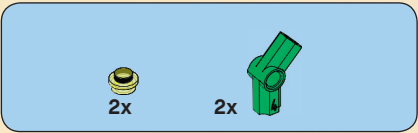
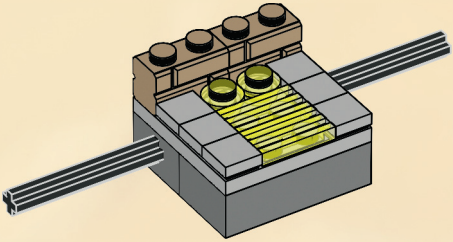

7

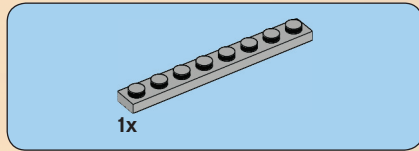
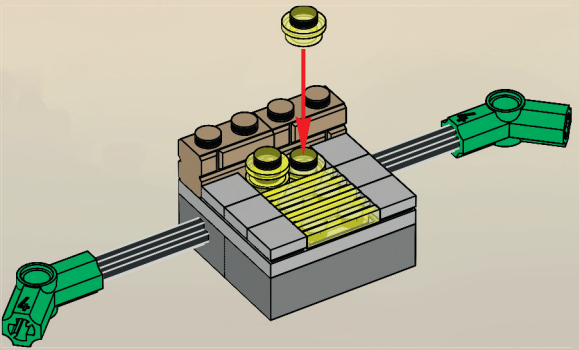

8

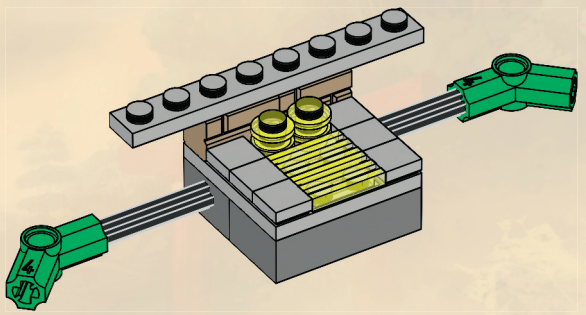



9

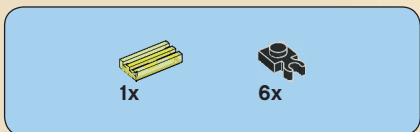
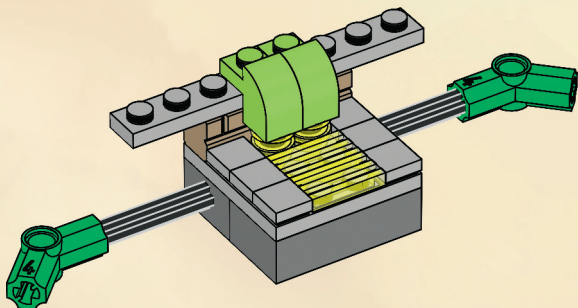

10

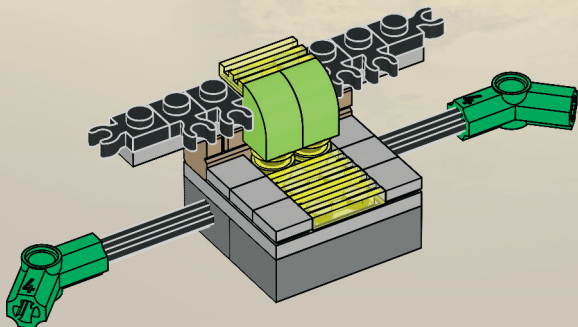

8

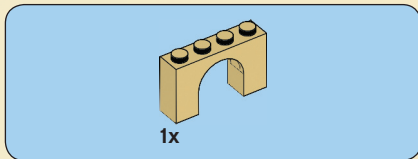

11

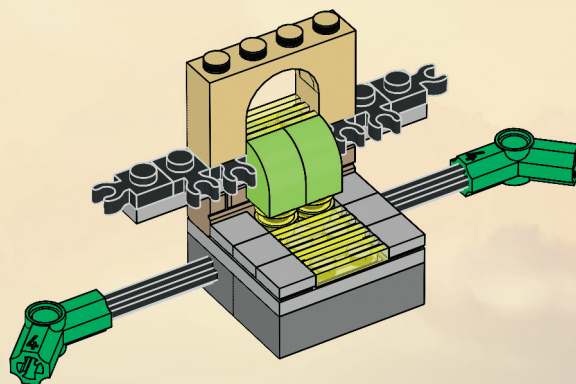



4x

12

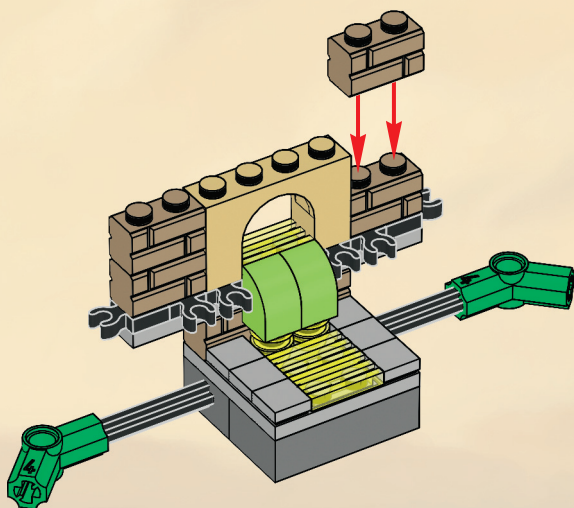

2x



1x

13

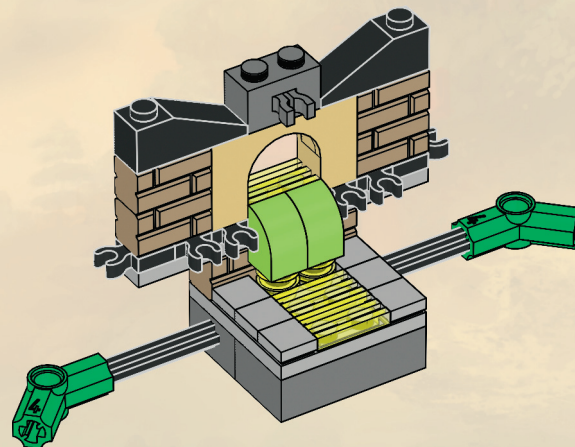

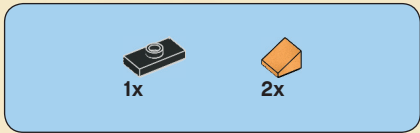

14

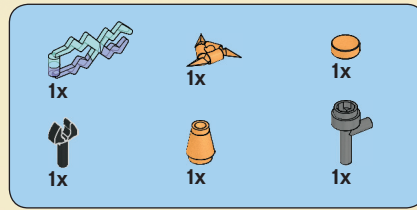
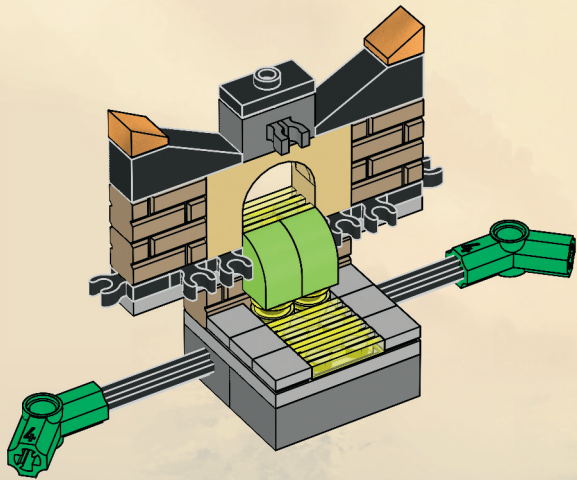

15

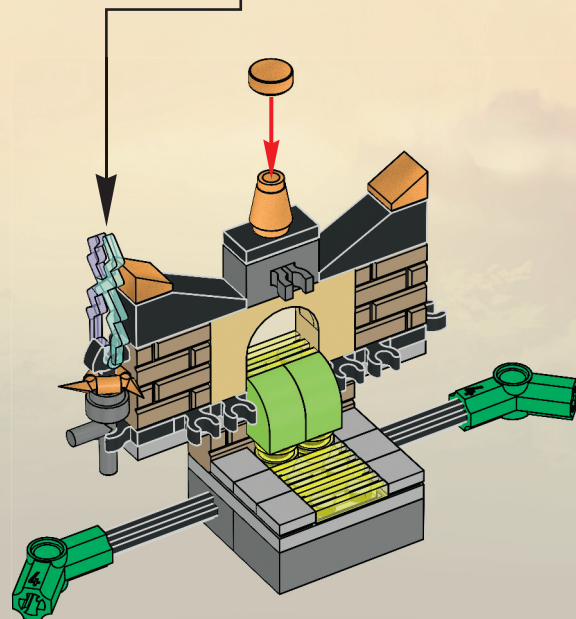
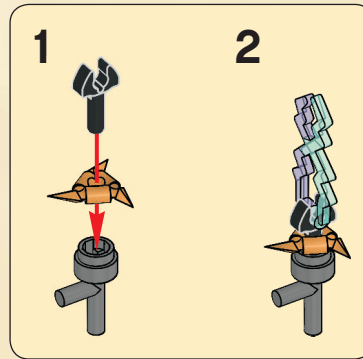

10



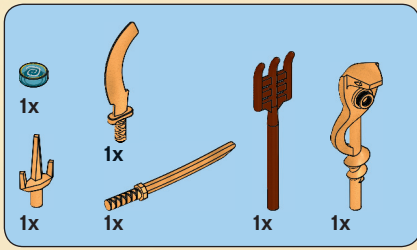

16

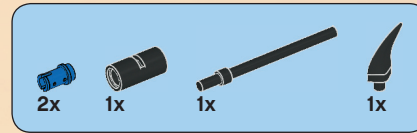
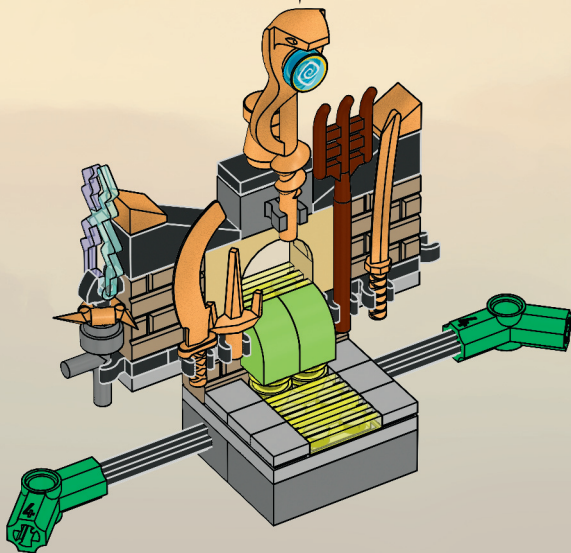
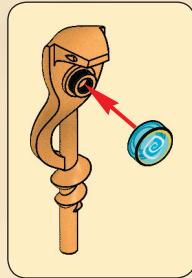

17

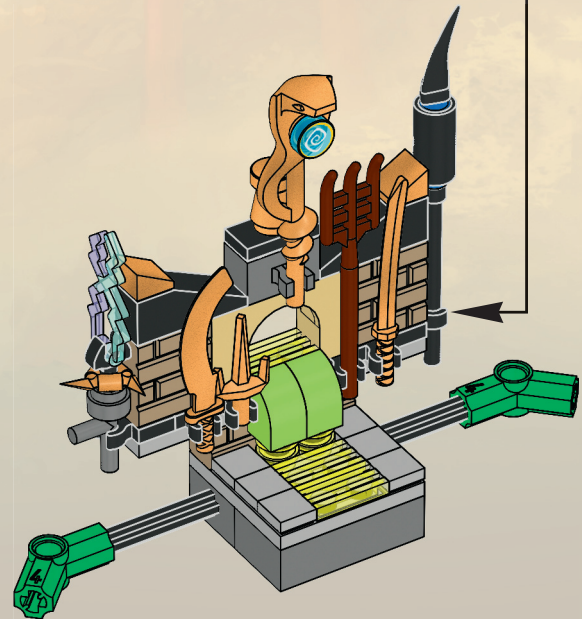
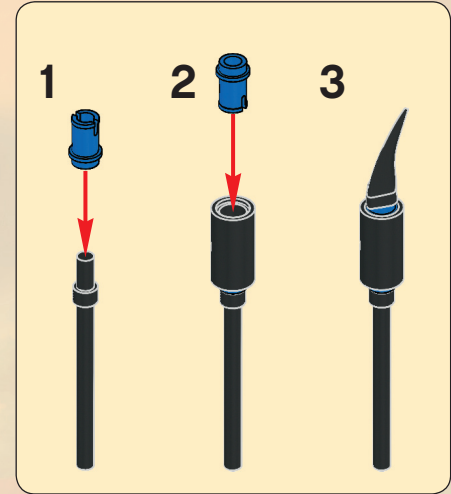

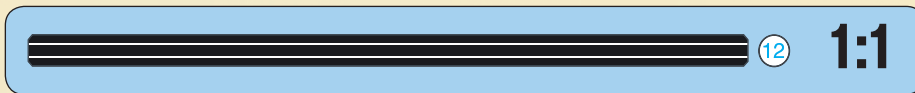
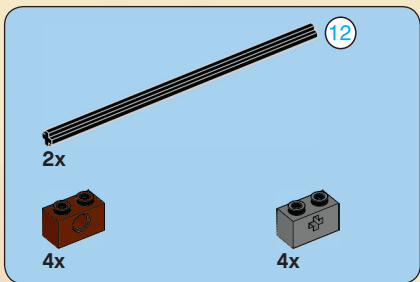

18

1



2

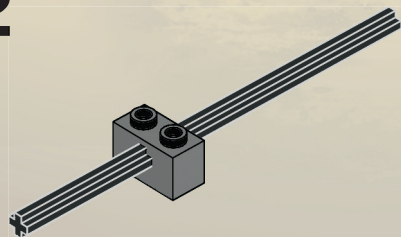

3

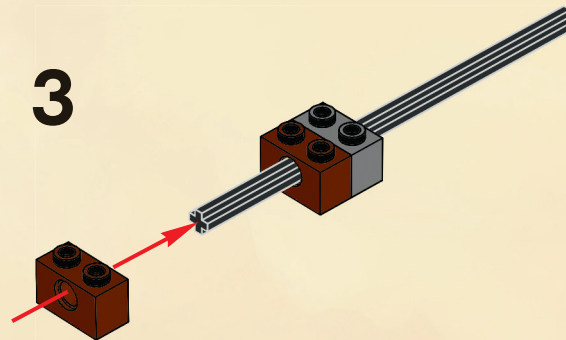

4

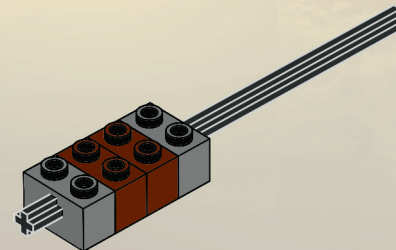

2x

12



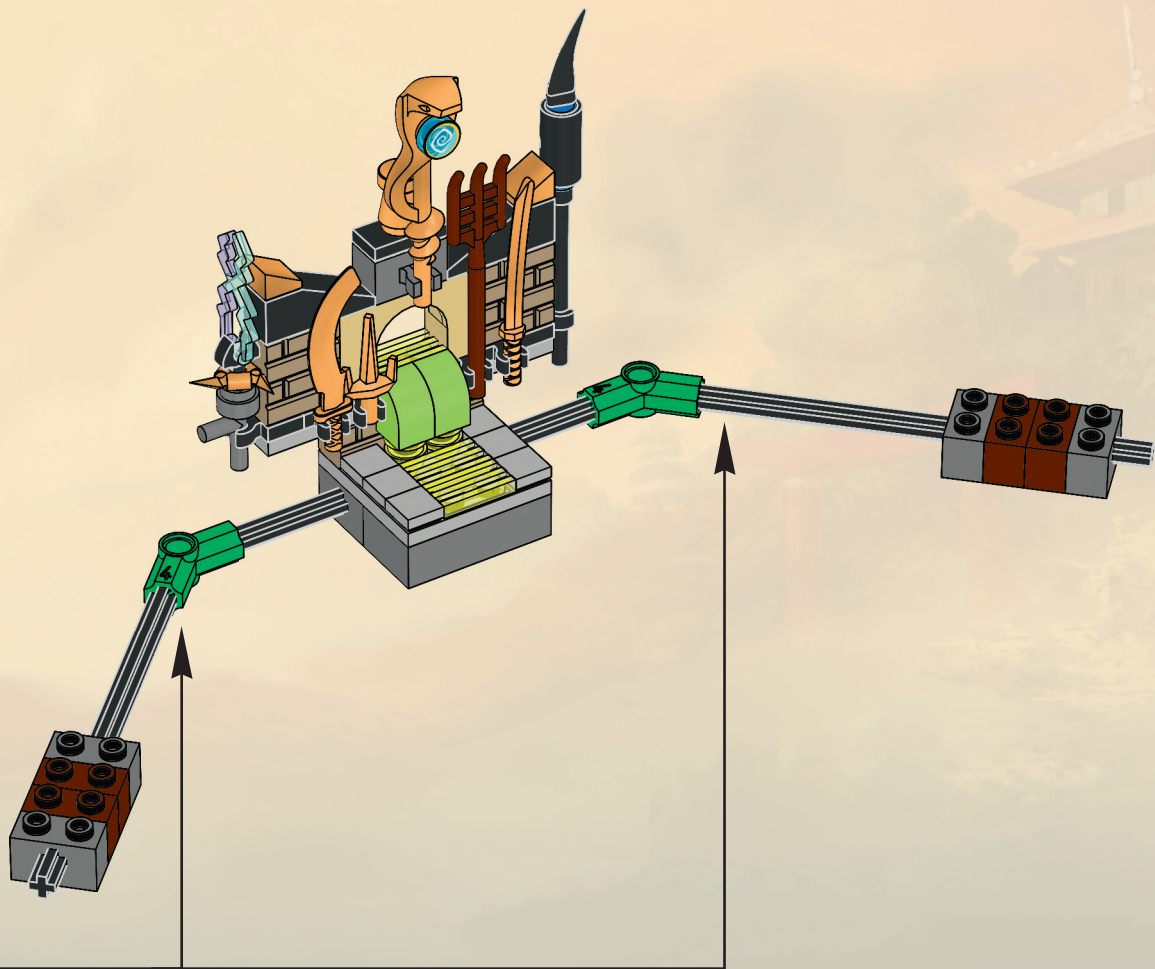

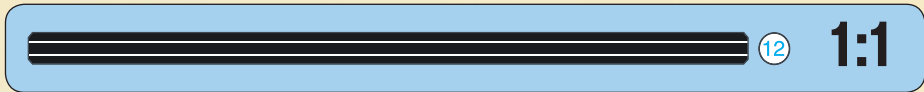
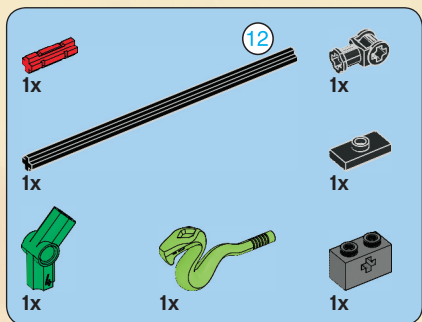

19



1

12

2

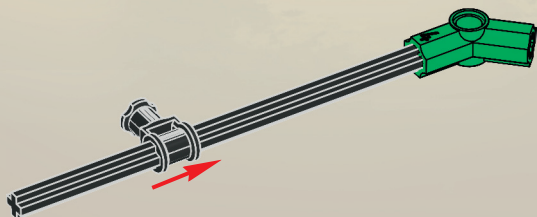

3

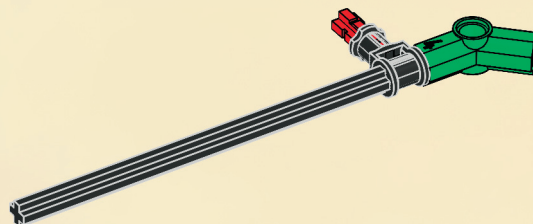

4

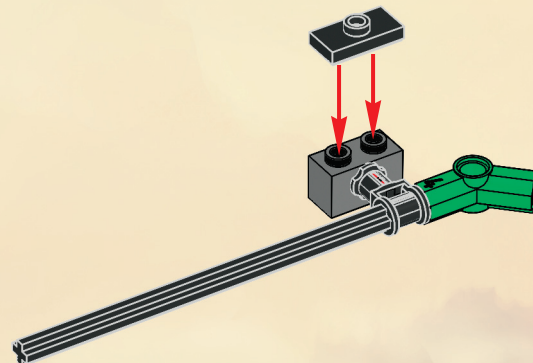

5

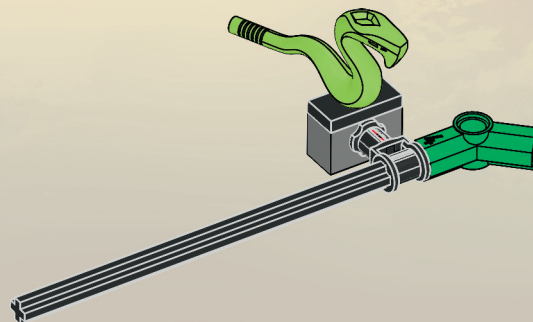

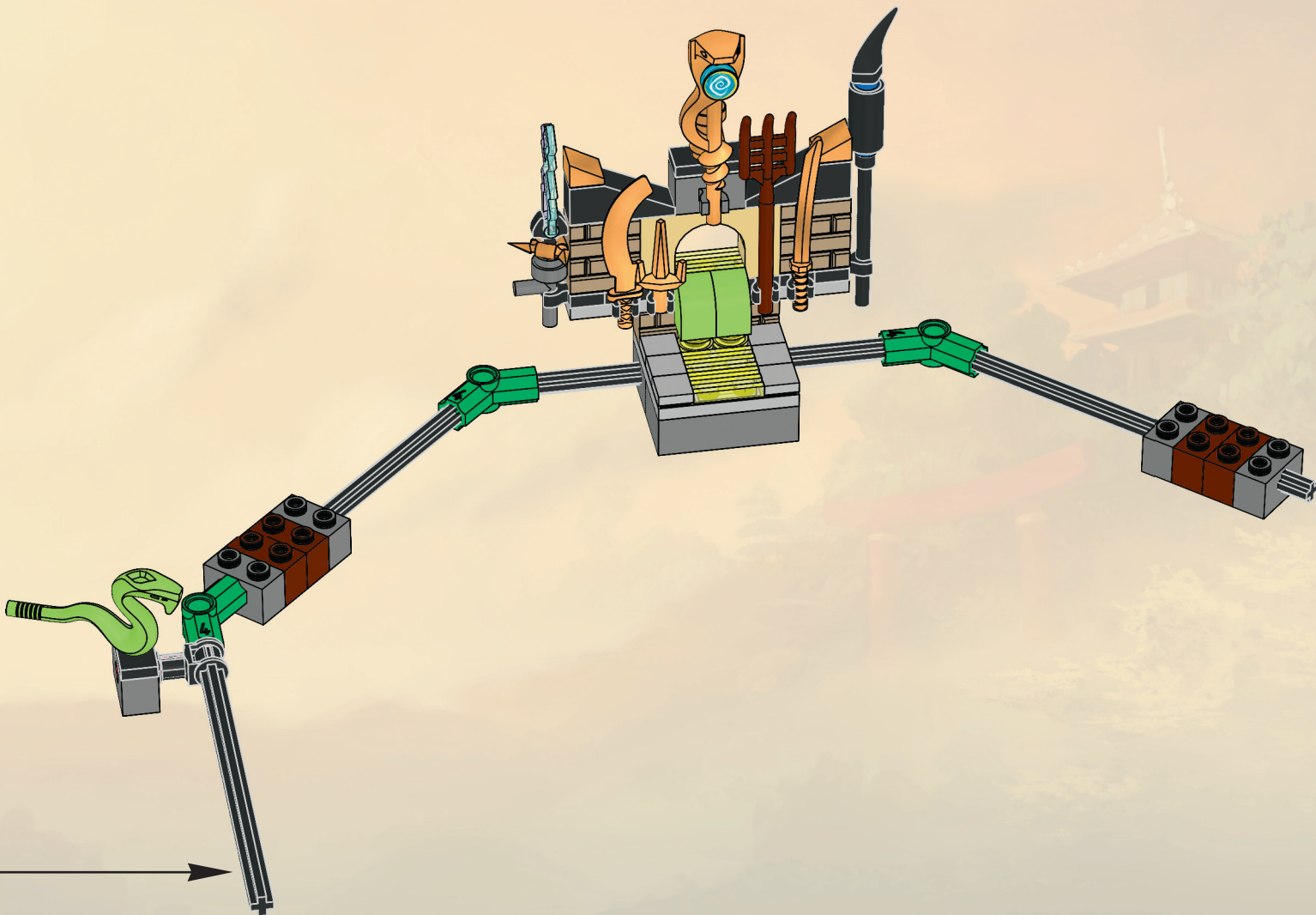

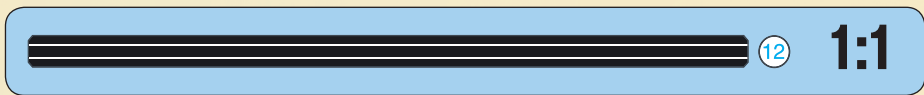
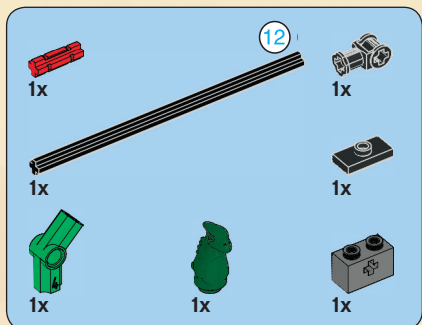

20

1

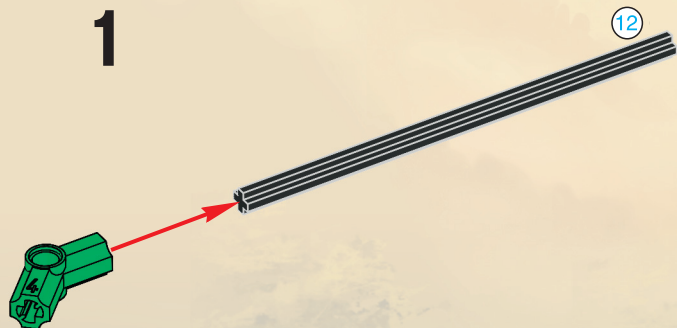

2

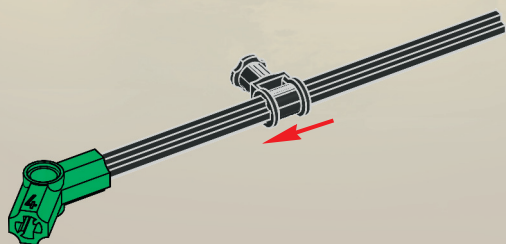

16

3

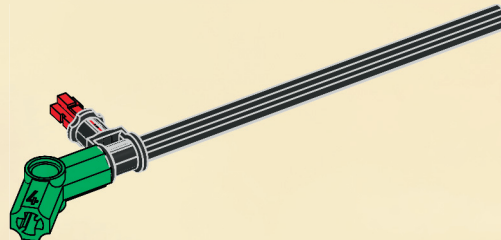

4

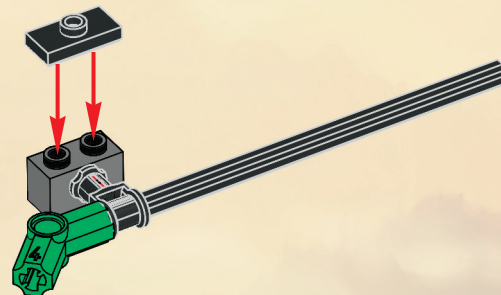

5

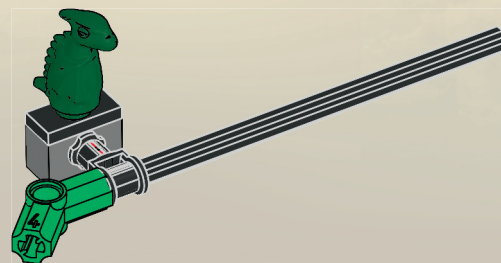



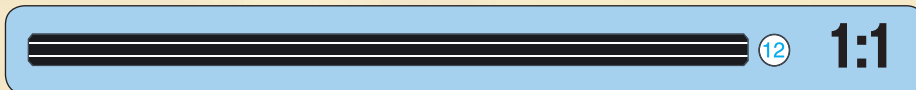
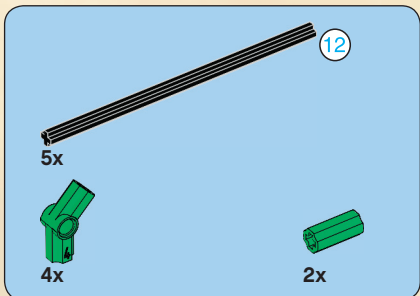
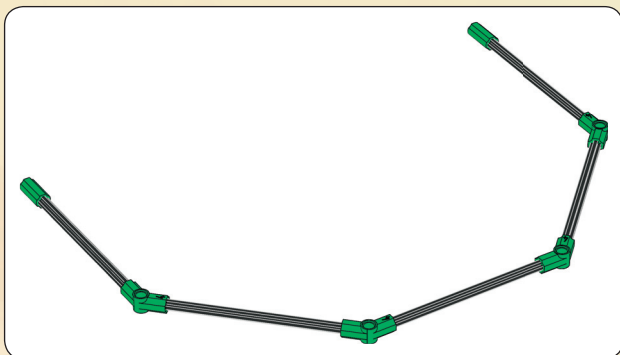

21

1

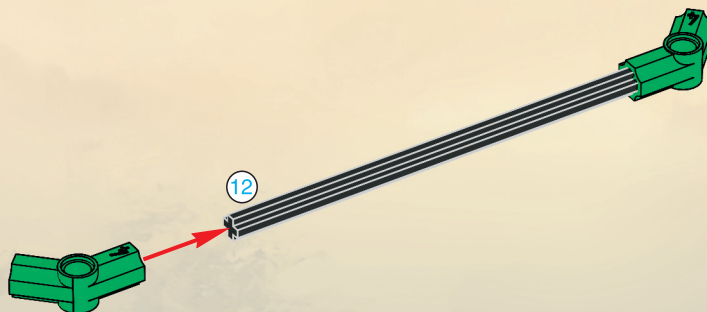



2

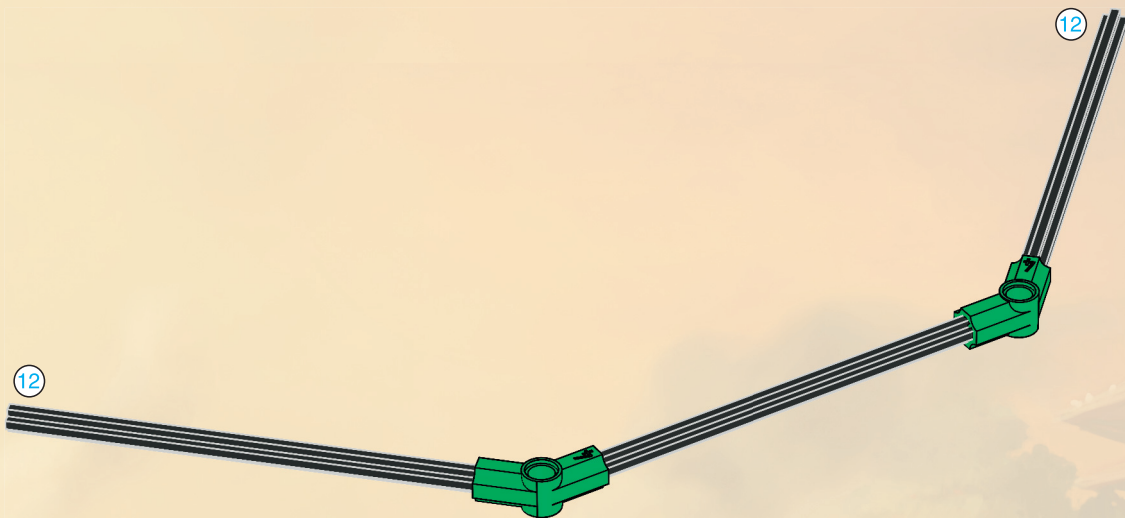

3

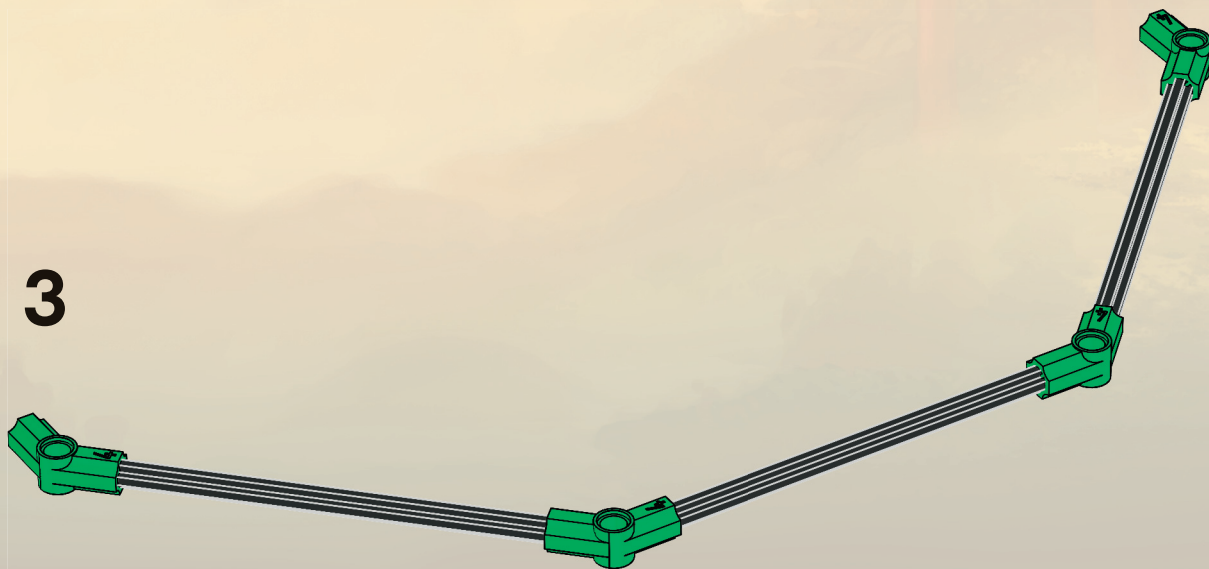



4

12

12



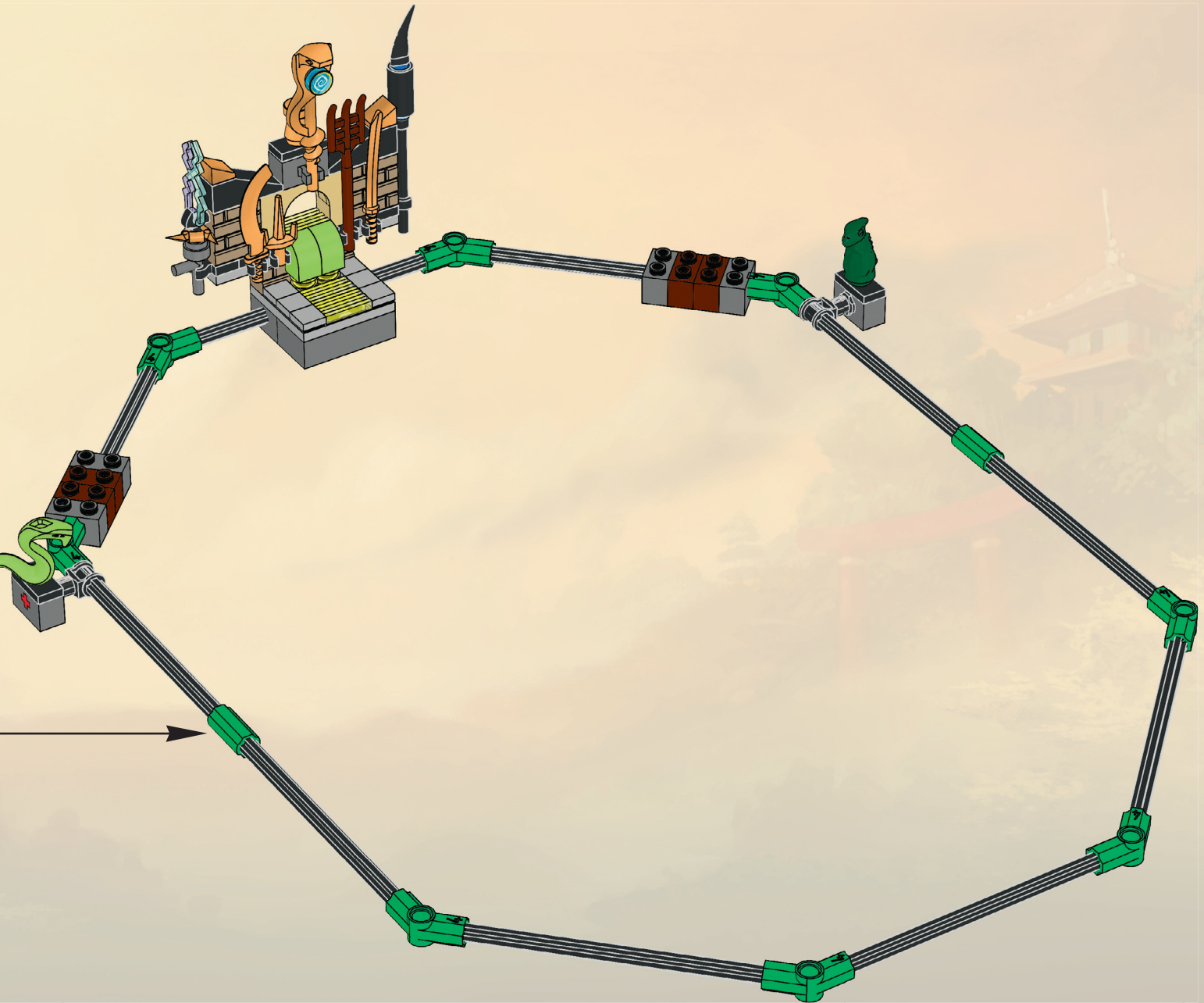

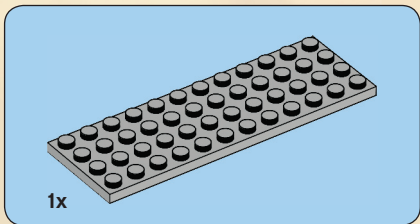
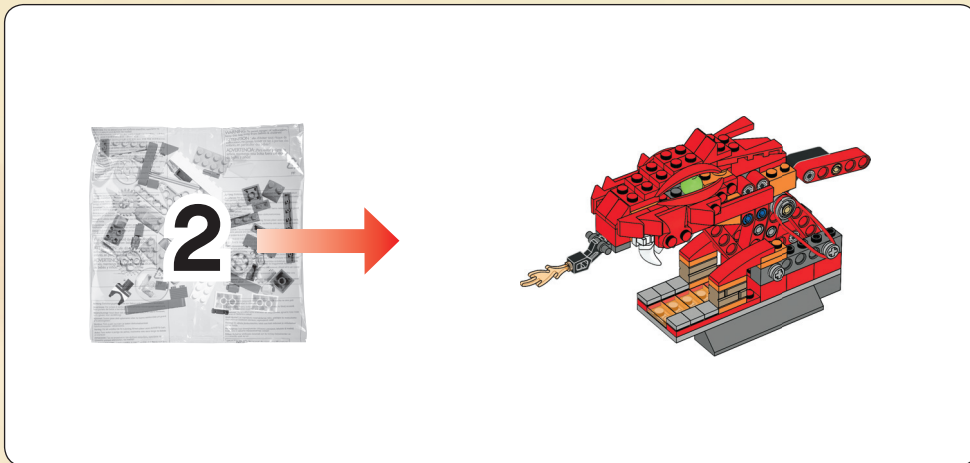

1

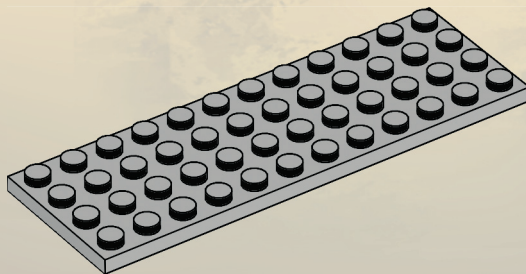

2

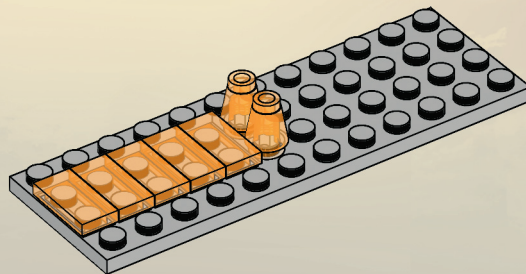

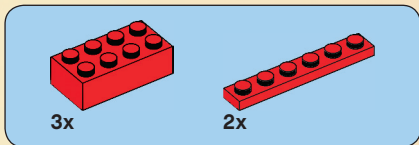

3

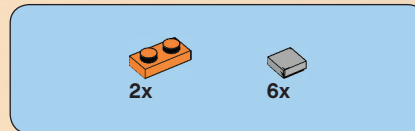
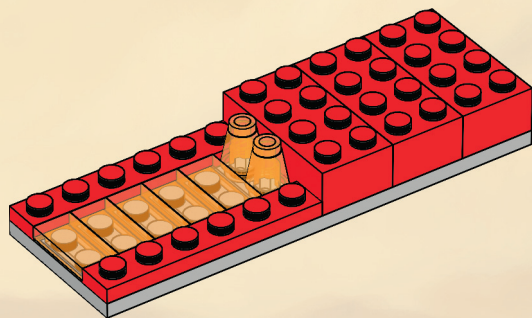

4

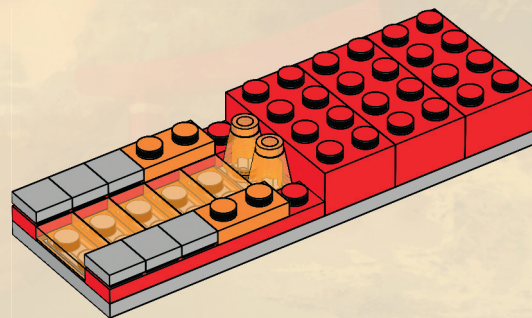

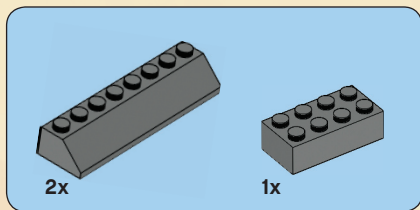

5

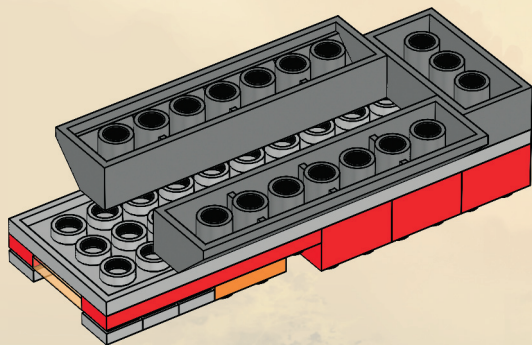
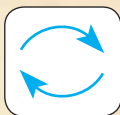

6

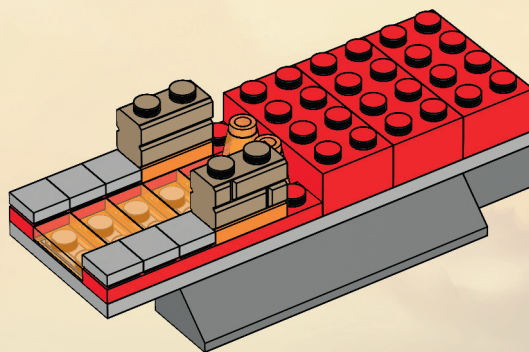
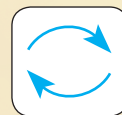

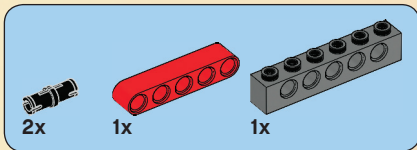

7

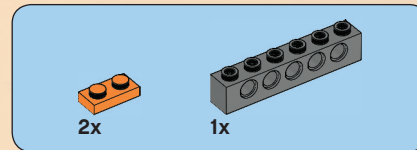
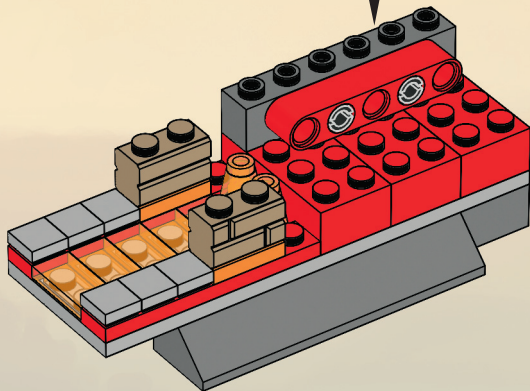
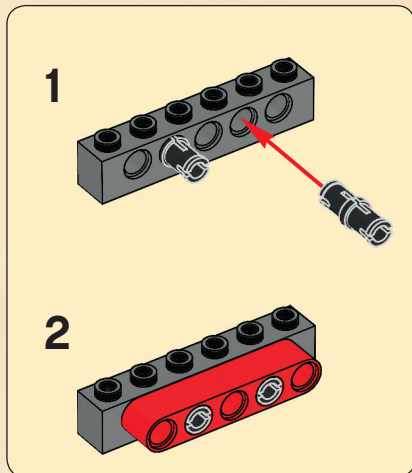

8

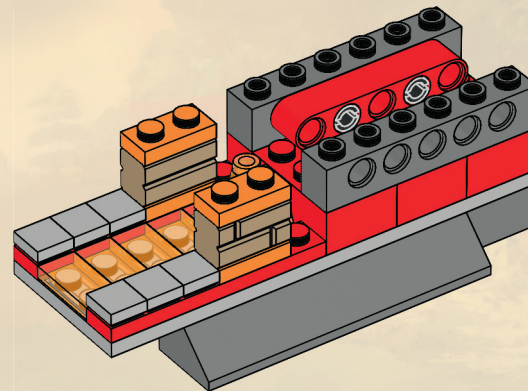

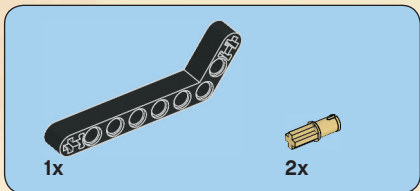
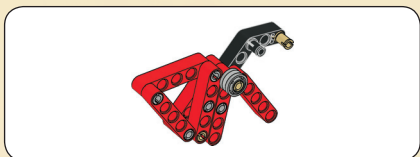

1

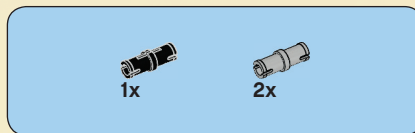
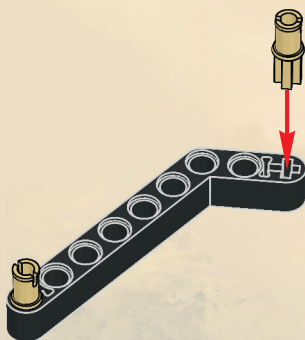

2

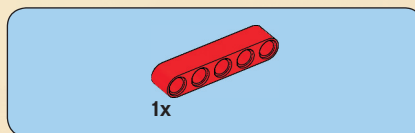
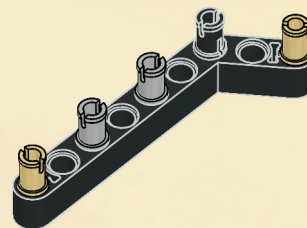

3

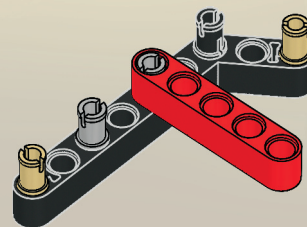

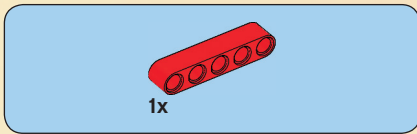

4

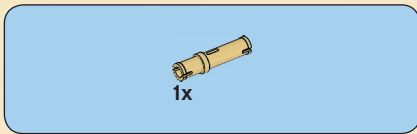
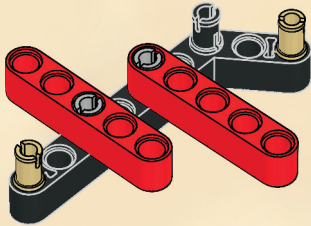

5

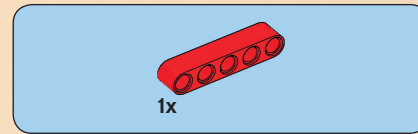
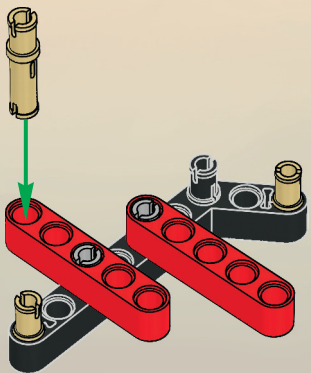

6

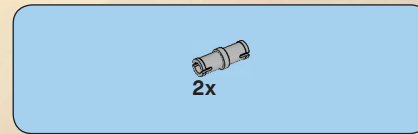
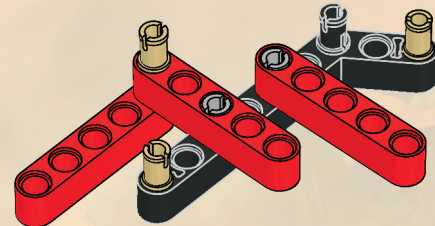

7

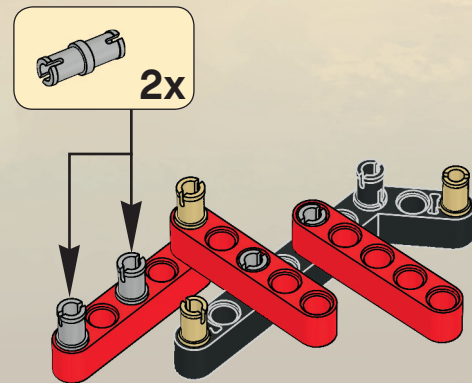

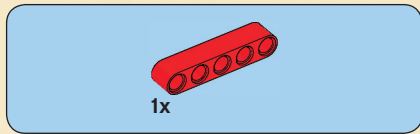

8

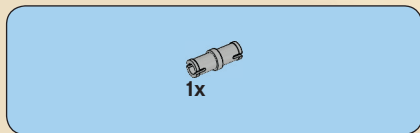
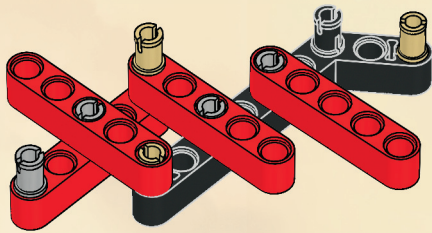

9

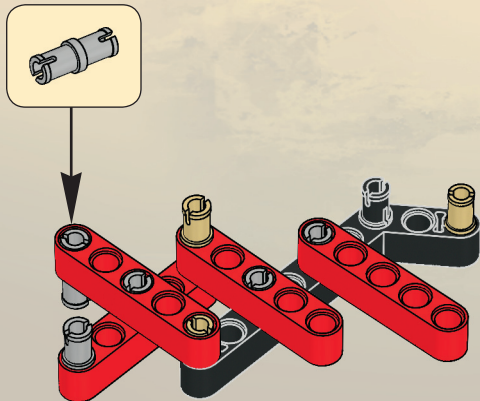

28

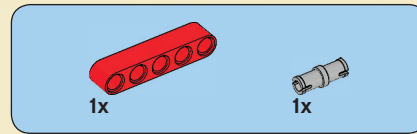

10

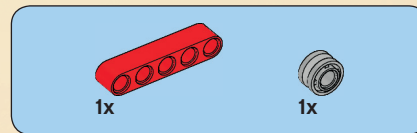
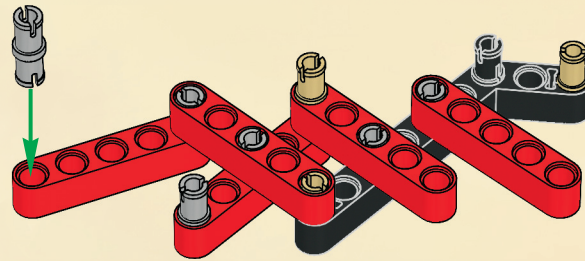

11

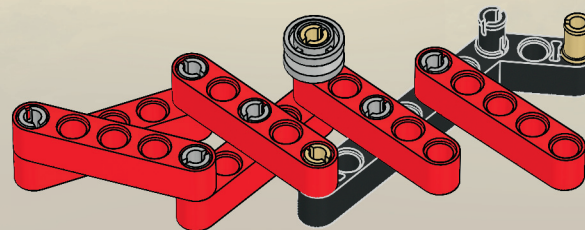

12

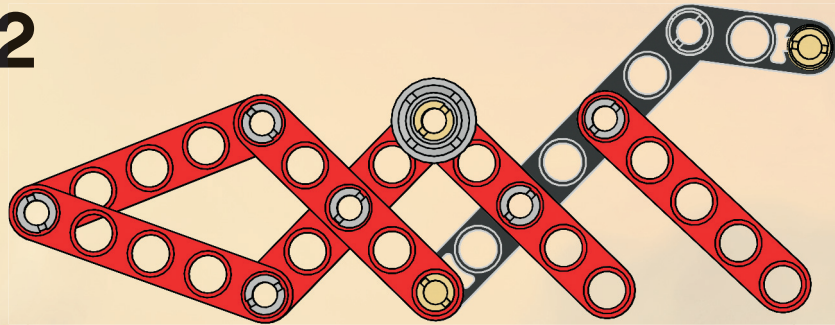

1:1

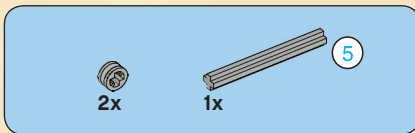

13

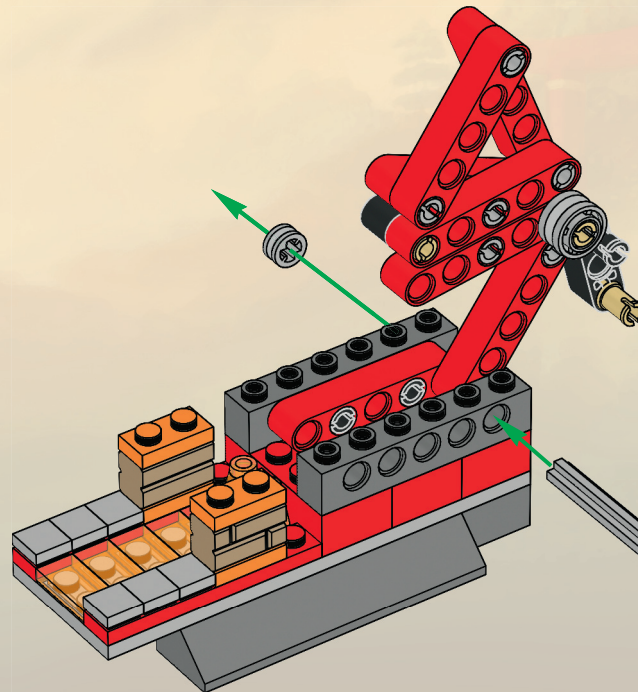
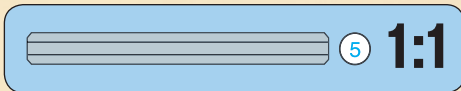

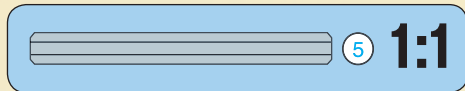
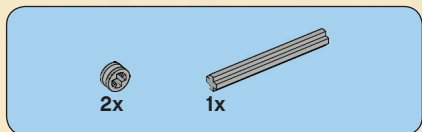

14

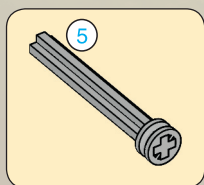
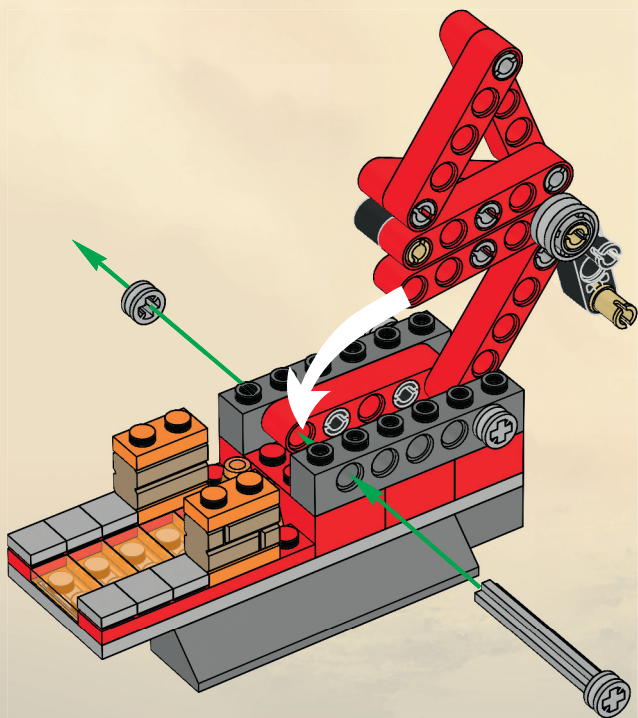

15

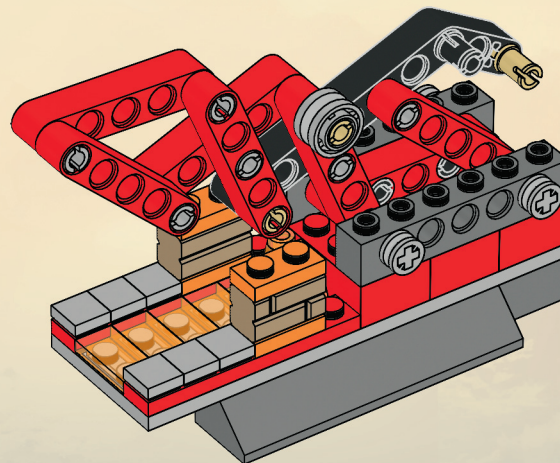

30



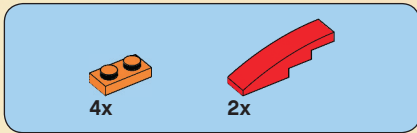

16

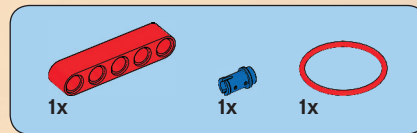
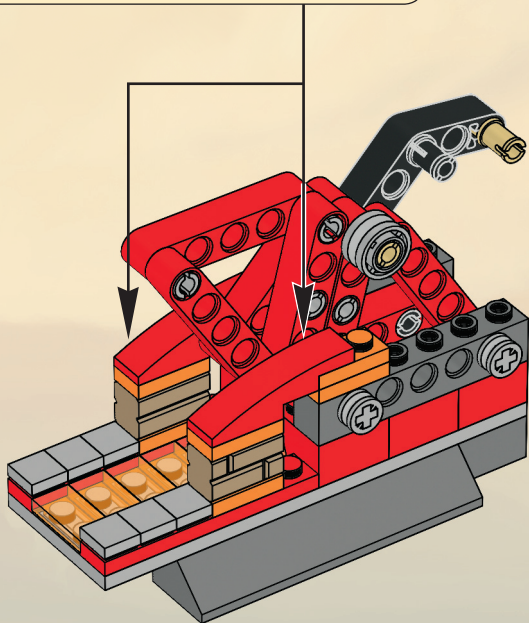
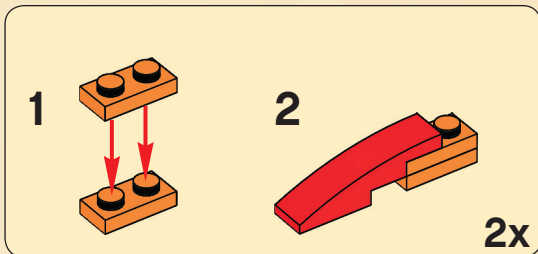

17

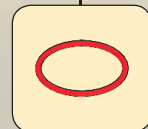
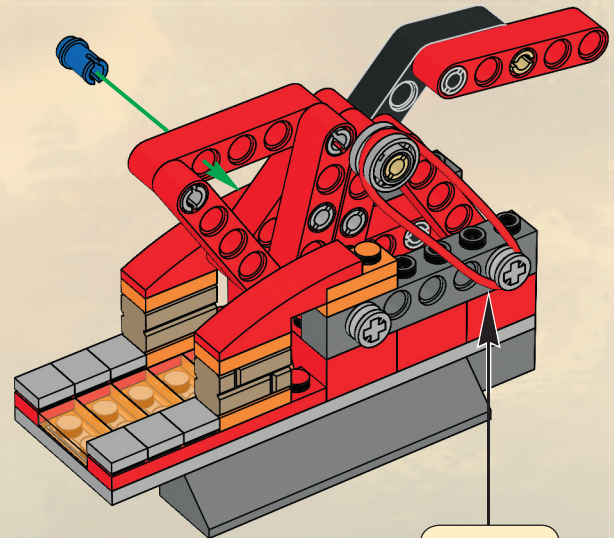

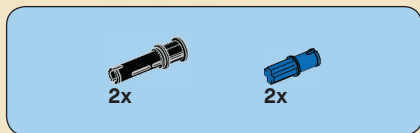

18

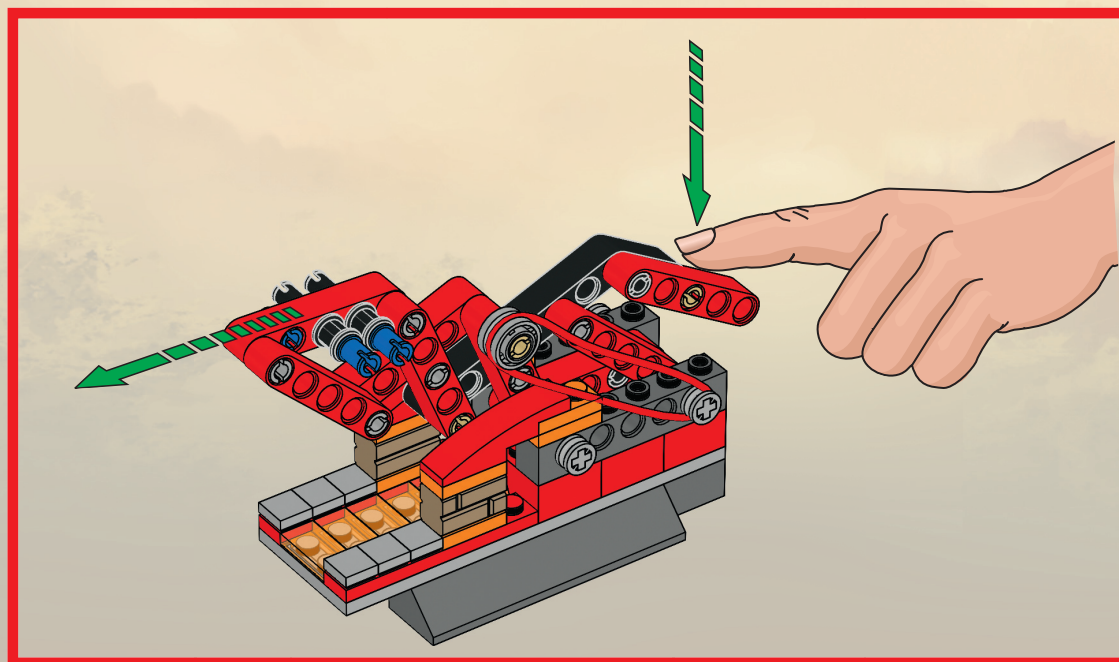
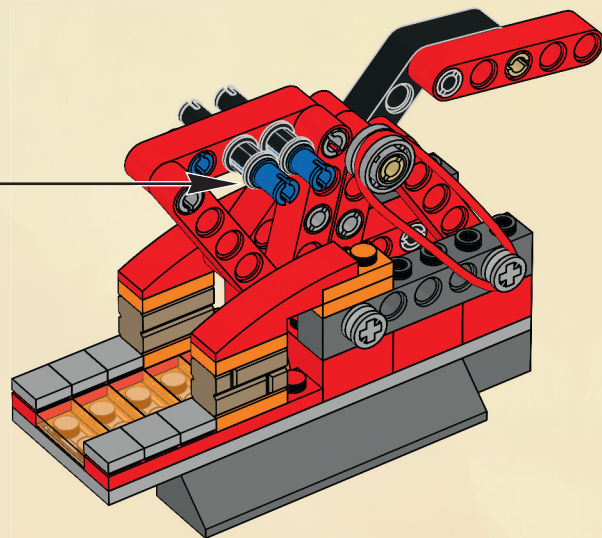
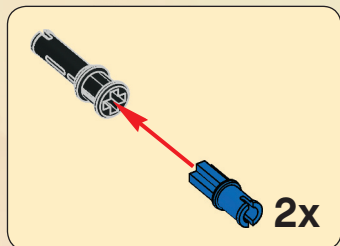

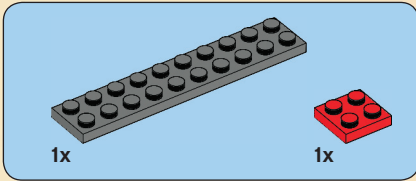
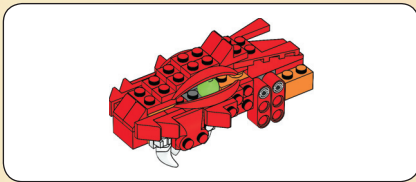

1

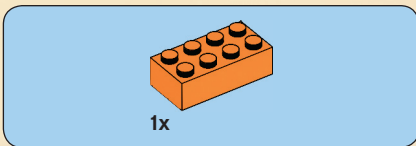
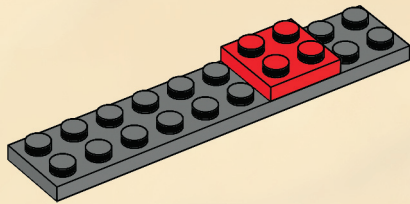

2

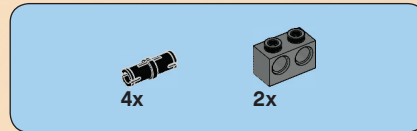
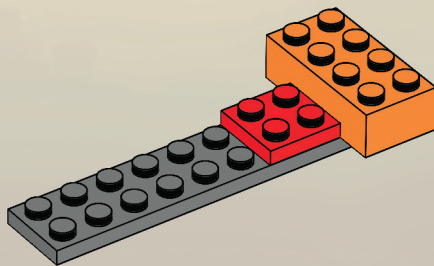

3

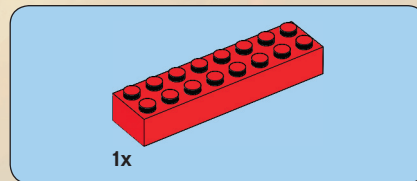
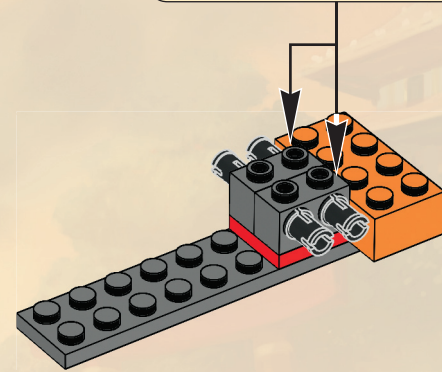
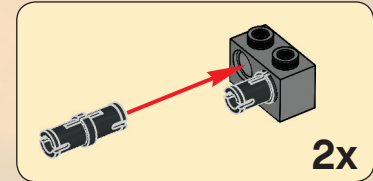

4

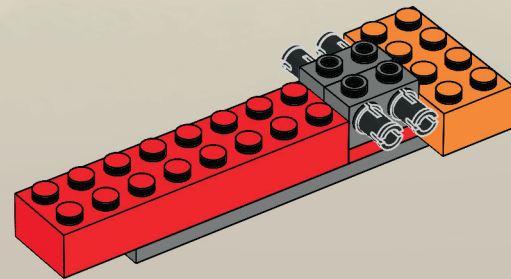

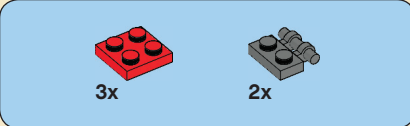

5

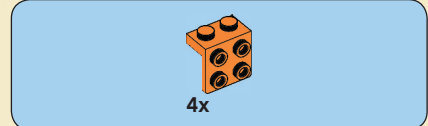
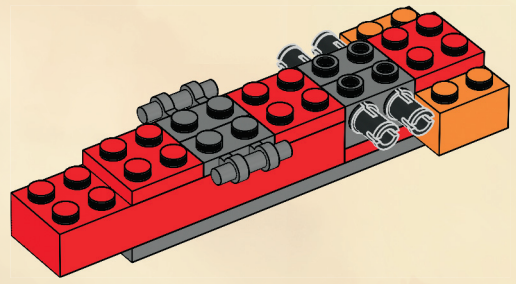

7

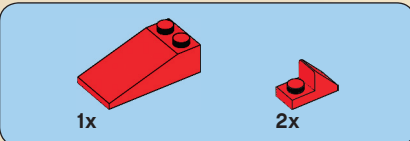
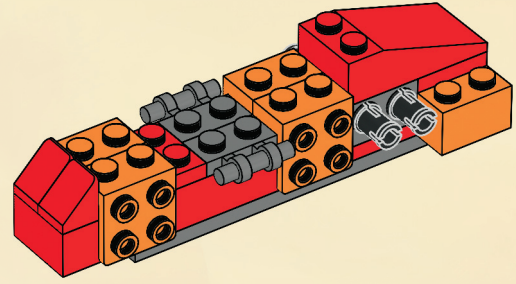

6

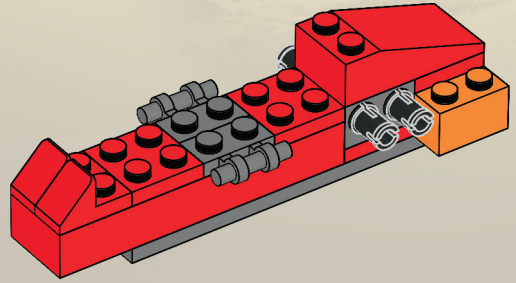

8

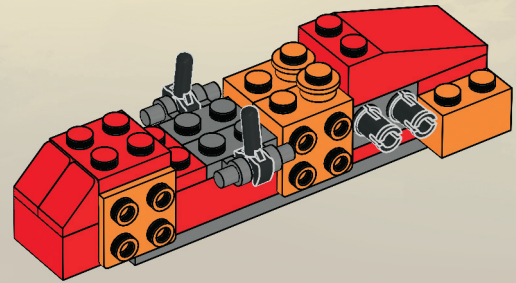

2x

9

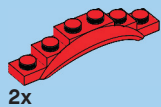
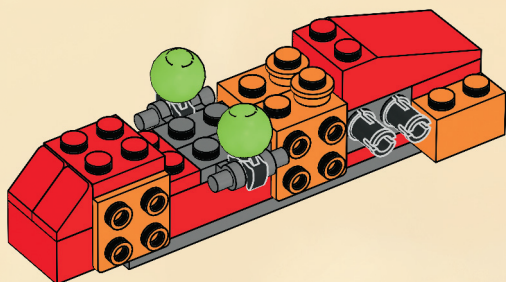

2x

10

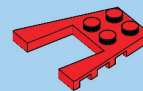
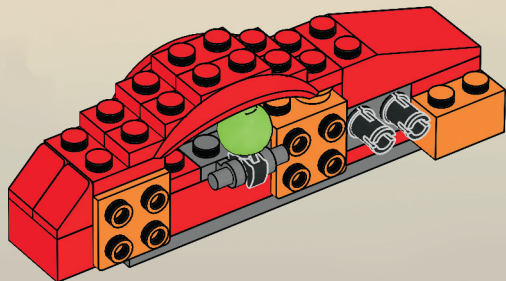

1x

11

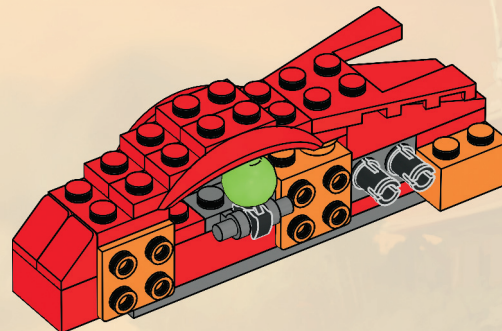

1x

2x

12

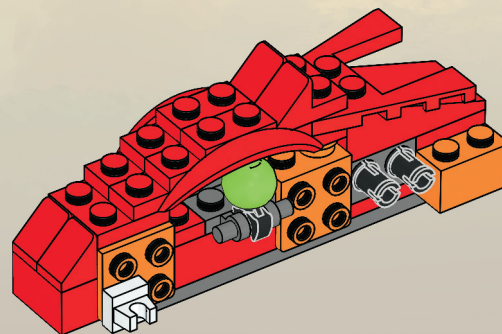

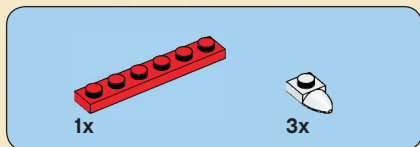

13

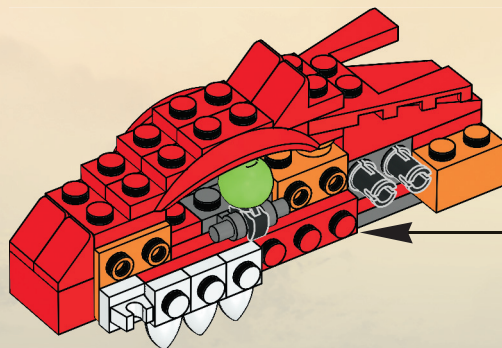
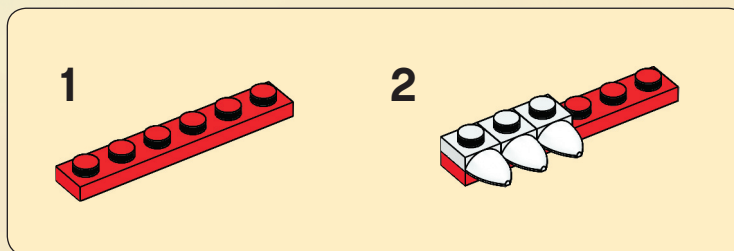

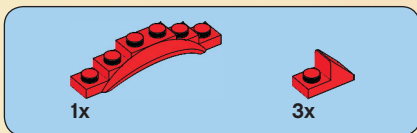

14

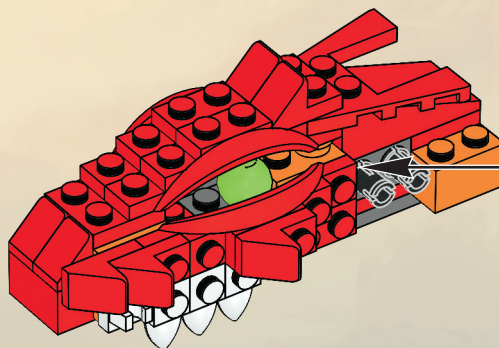
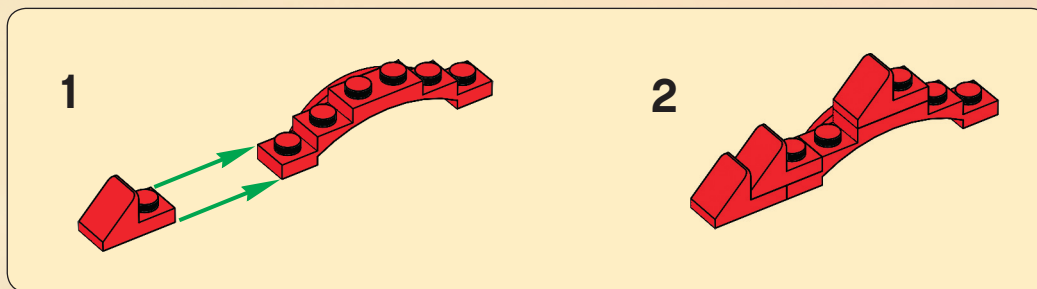



15

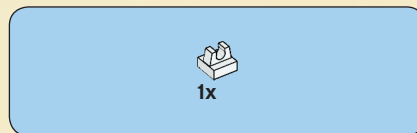
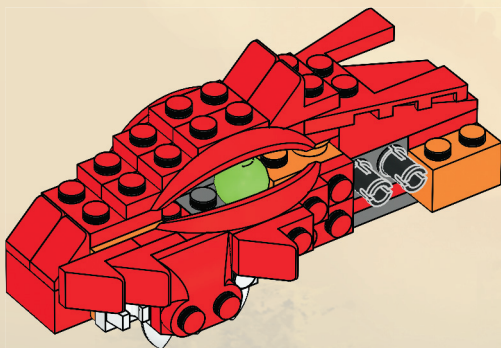

16

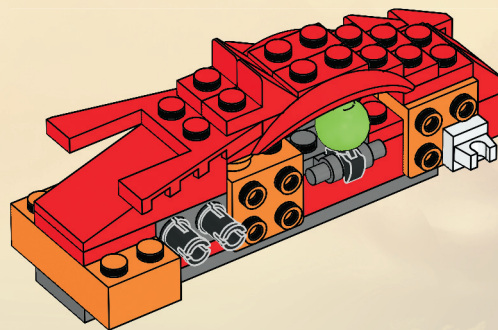
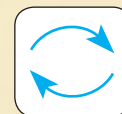

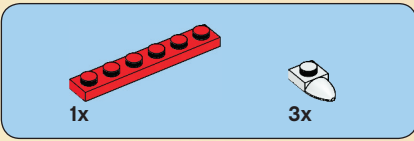

17

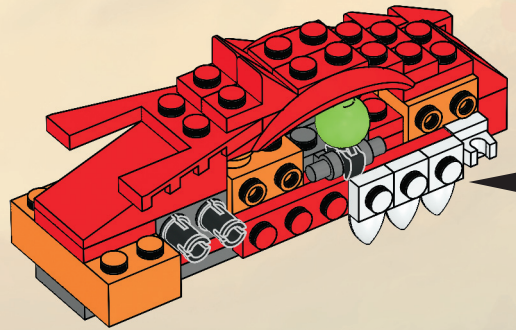
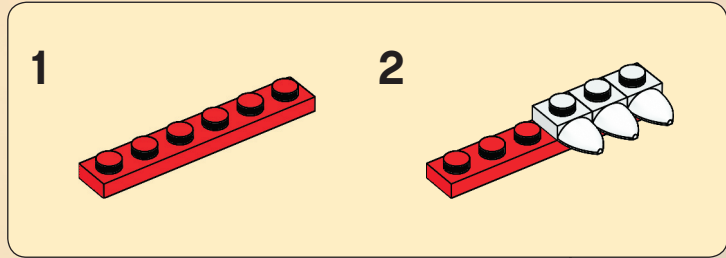

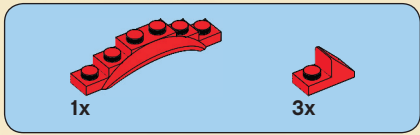

18

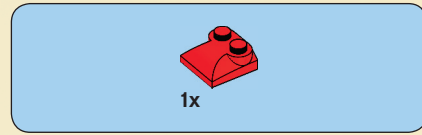
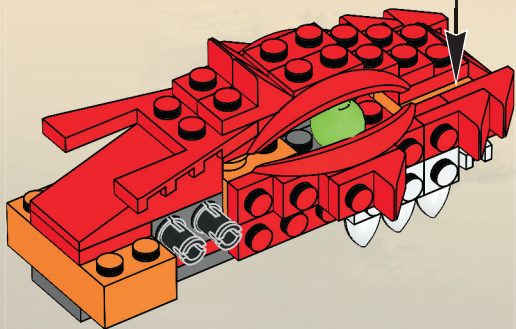
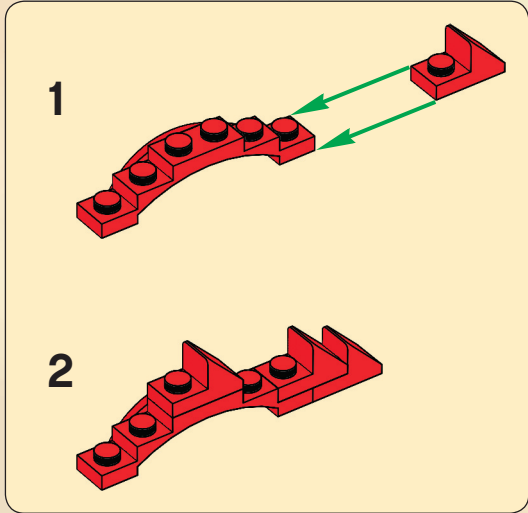

19

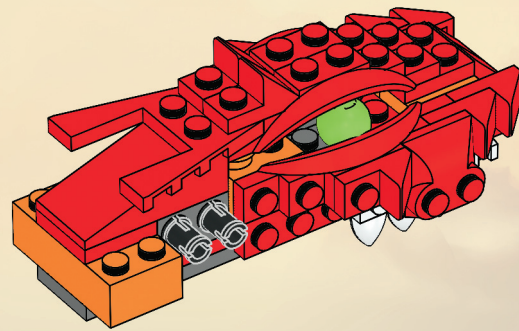

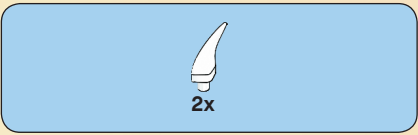

20

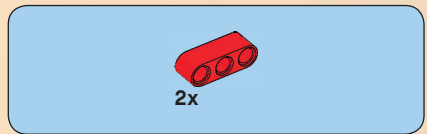
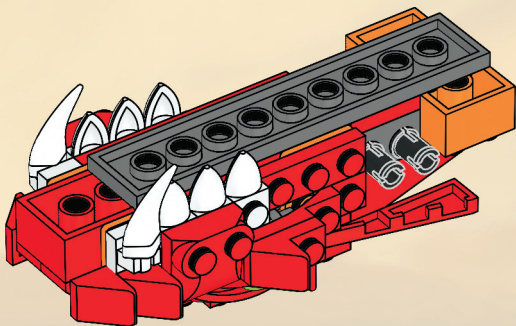

21

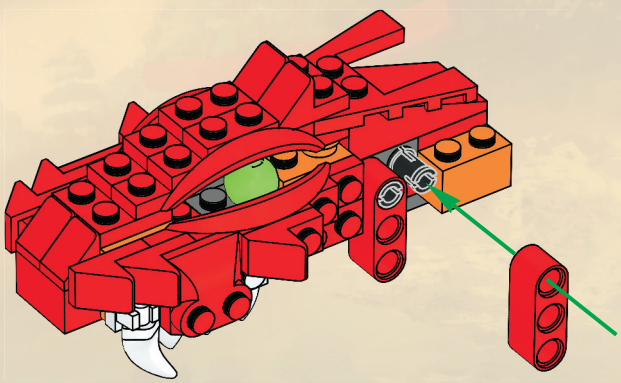



22

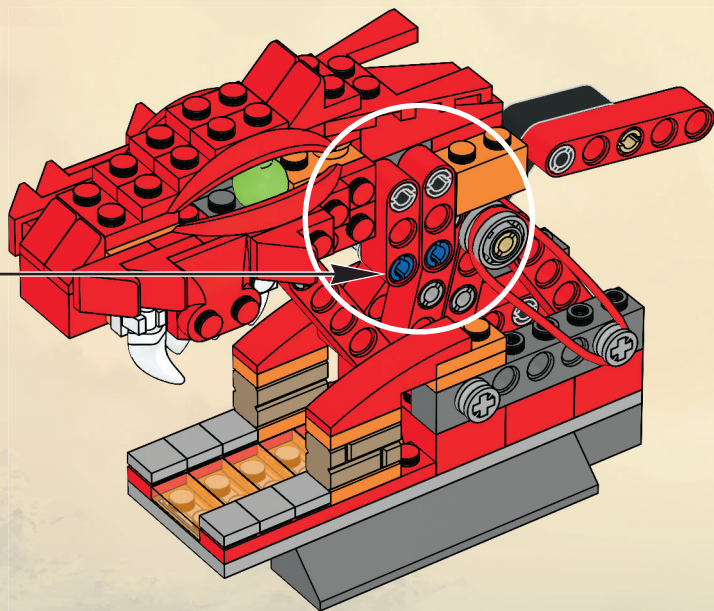

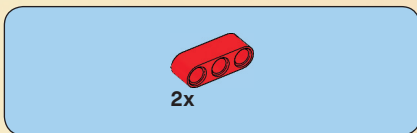

23

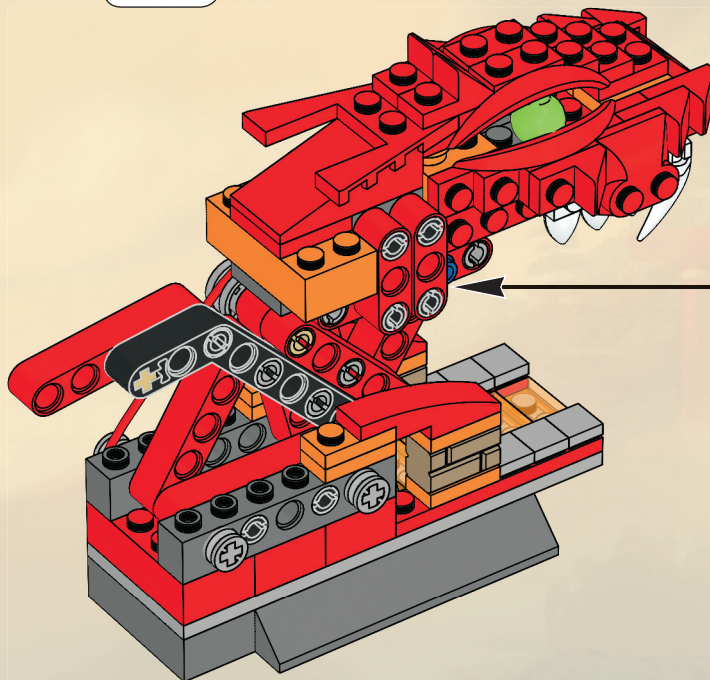
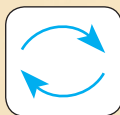

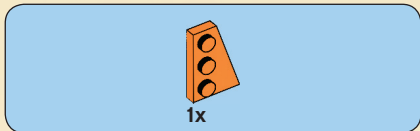

24

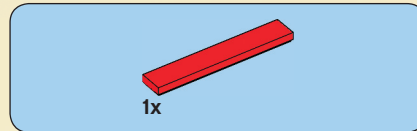
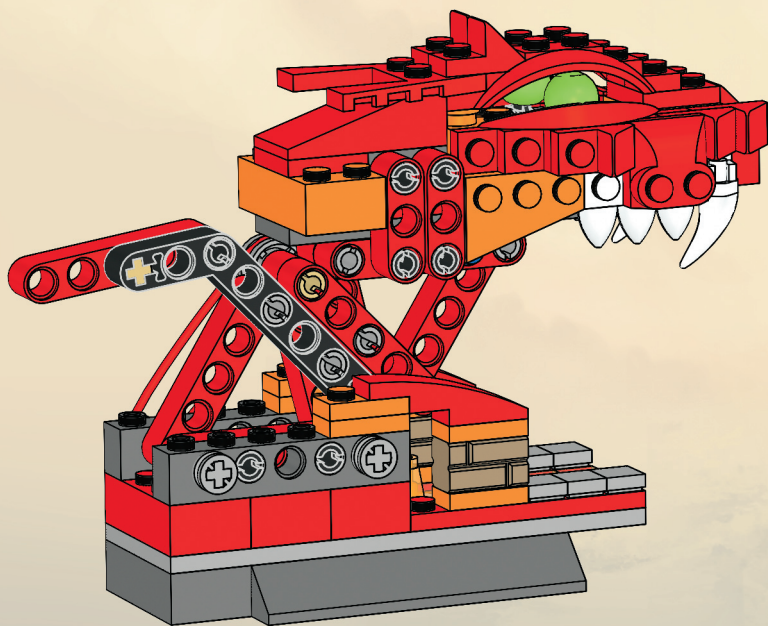

25

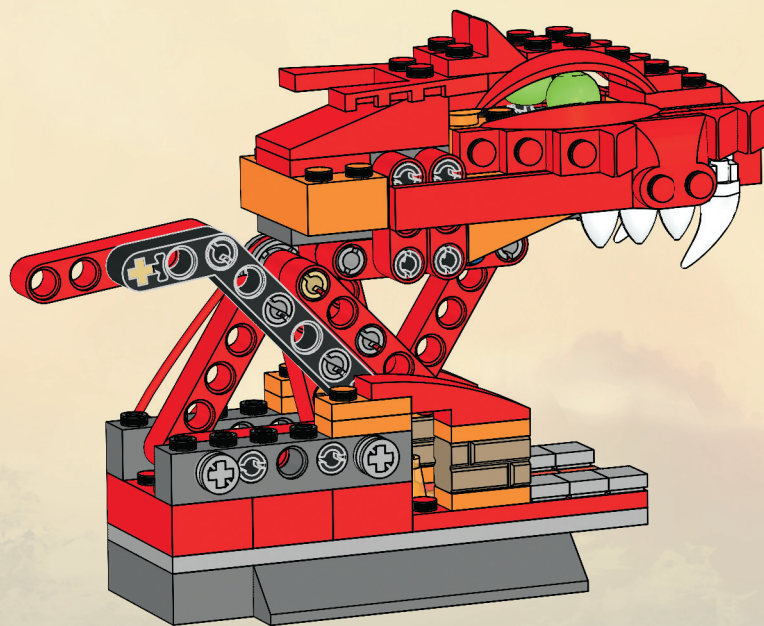

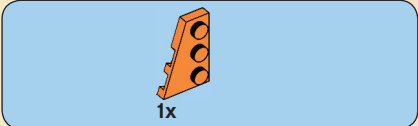

26

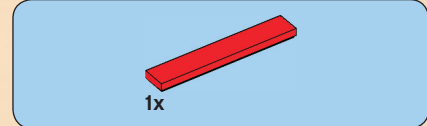
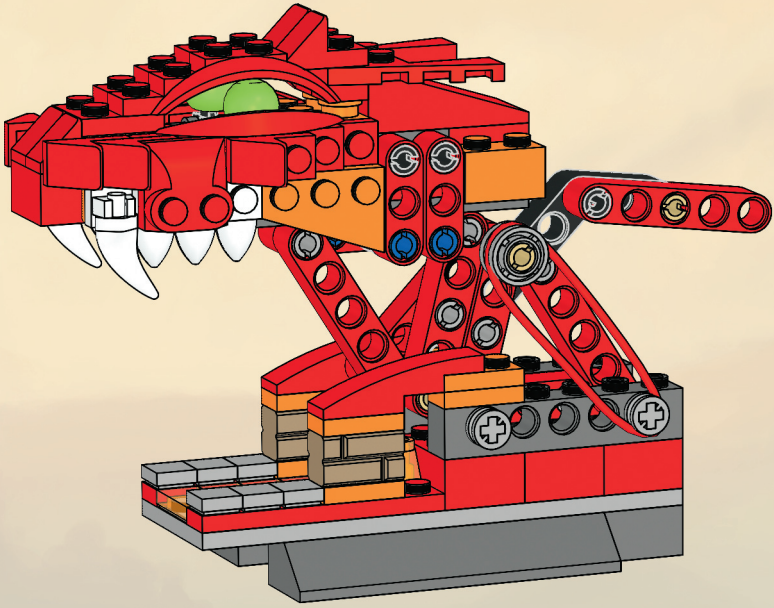
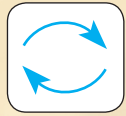

27

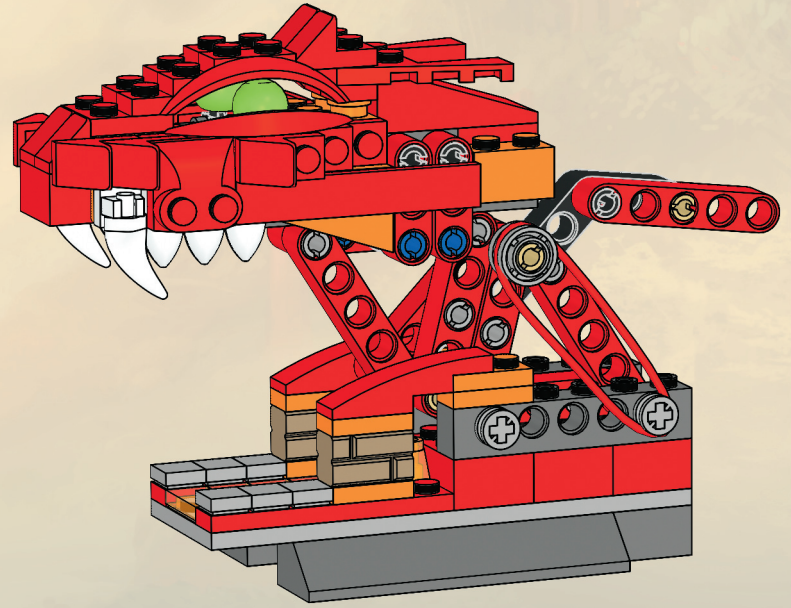

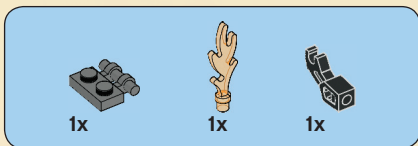

28

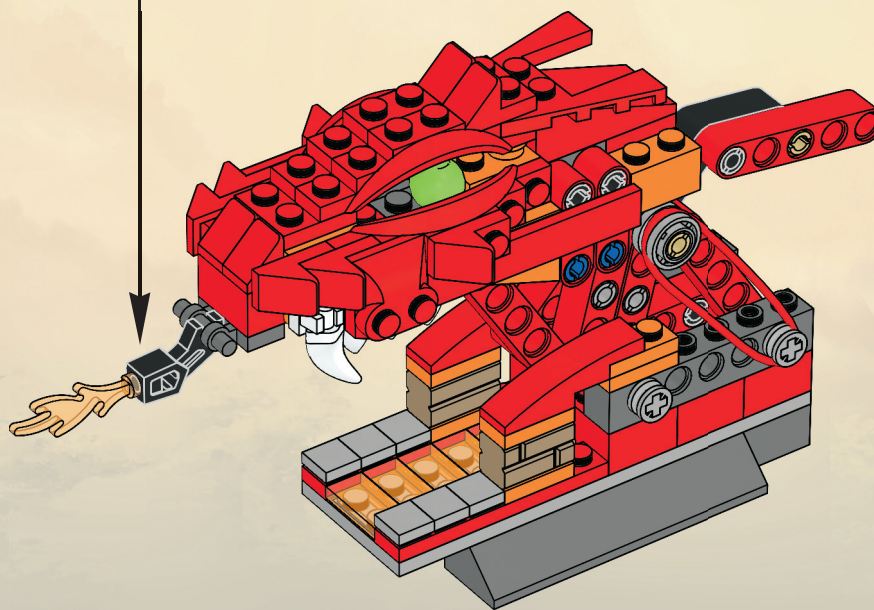
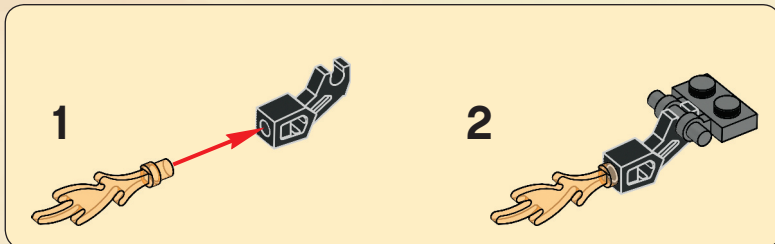

29

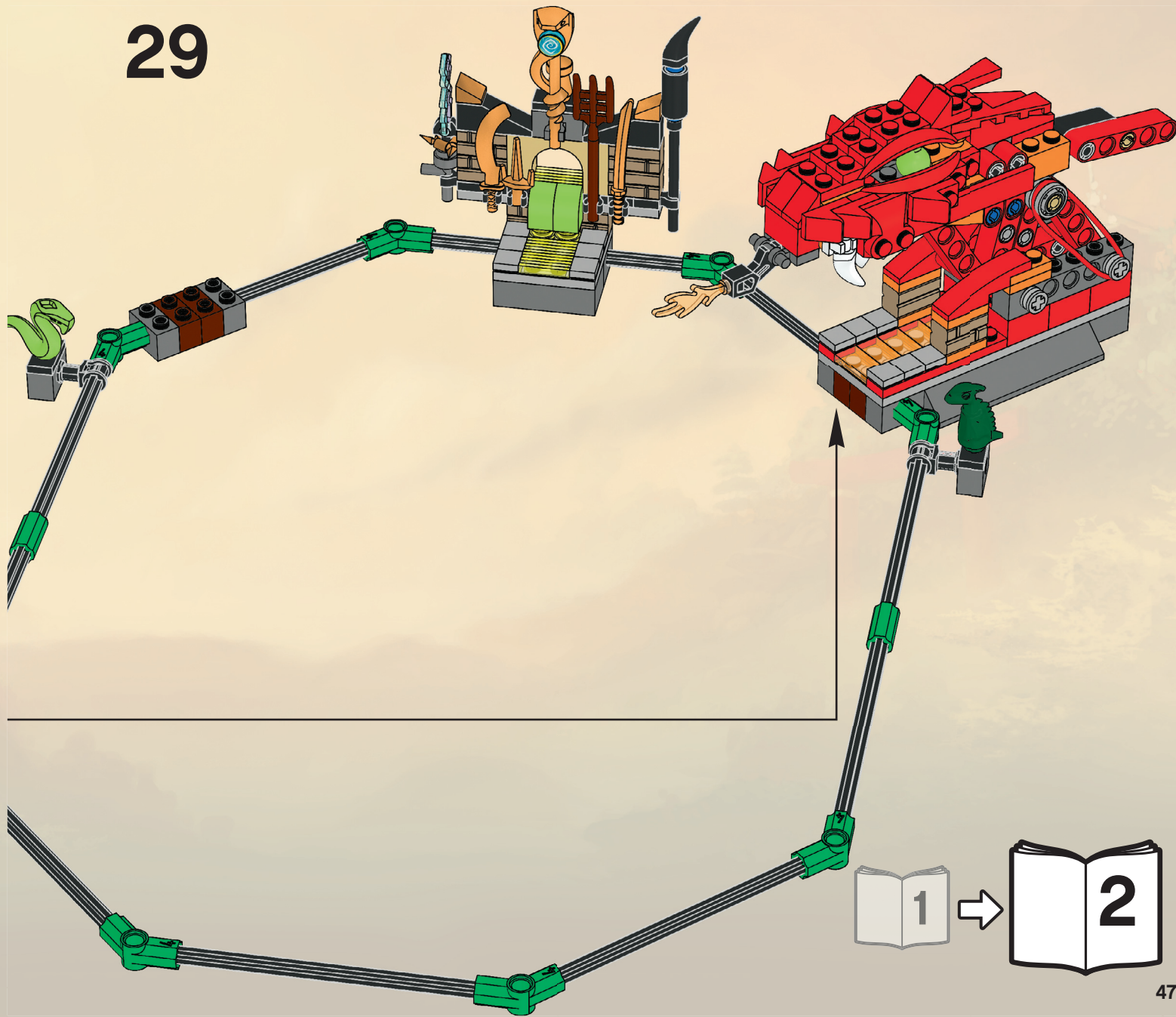

LEGO club
FREE! GRATIS! GRATUIT!



www.LEGOclub.com



LEGO® Club Magazine



LEGO® Club Email

VISIT THE WORLD'S
BIGGEST LEGO® SHOP!

www.LEGOshop.com

00800 5346 5555



1-866-534-6258 • 1-877-518-5346

US & Canada only

Canada seulement

- * Freephone. Mobile charges may apply.
- * Numéros sans frais. Des frais peuvent s'appliquer avec les téléphones cellulaires.
- * Gebührenfrei, Kosten für Anrufe aus Mobilfunknetzen können abweichen.
- * Gratis telefonnummer vanaf vaste lijn.
- * Det er et gratis nummer, når du ringer fra fasttelefon.
- * Det är gratis, när du ringer från en fast telefon.
- * Numéro sans frais. Des frais peuvent s'appliquer avec les téléphones portables.



BI115

YES! I want to join the LEGO® Club FREE! **OUI!** Je veux m'abonner au LEGO® Club GRATUITEMENT!

Ja! Ich möchte Mitglied im kostenlosen LEGO® Club werden. **Ja!** Ik wil graag GRATIS lid worden van de LEGO® Club. **Ja!** Jeg ønsker å melde meg inn i LEGO® Club gratis! **Ja!** Jag vill gå med i LEGO® Club GRATIS!

First name • Prénom
Vorname • Voornaam
Fornavn • Förnamn

Last name • Nom de famille
Name • Achternaam •
Etternavn • Efternamn

Date of Birth • Date de naissance
Geburtsdag • Geboortedatum
Fødselsdato • Födelsedatum

Boy • Garçon •
Junge • Jongen •
Gutt • Pojk

Girl • Fille •
Mädchen • Meisje
Jente • Flicka

Street • Adresse
Straße, Hausnr.
Straat, huisnr. • Adress

City • Ville
Ort • Woonplaats
Poststed • Postort

State
Prov. County

Zip/Postcode
Code Postal • PLZ
Postcode
Postnummer

Country
Pays Land

Email • Courriel
E-Mail • E-post

- Fill in your email address and we will send you a membership confirmation and monthly email newsletters. If you do not wish to receive the newsletters please tick here. Remplis ton adresse e-mail et nous t'enversons une confirmation d'adhésion ainsi que le bulletin e-mail mensuel. Si tu ne désires pas recevoir le bulletin, coche cette case. Vul je e-mailadres in en we sturen je een bevestiging van je lidmaatschap en maandelijke e-mail nieuwsbrieven. Als je geen e-mail wilt ontvangen, kruis dan dit vakje aan.
- Ich möchte per E-Mail den monatlichen LEGO Club Newsletter erhalten. Ønsker du at vi skal sende en liten hilsen til barnet ditt for å bekrefte medlemskapet, ber vi deg krysses av i feltet, samt oppgi e-postadressen som hilsenen skal sendes til. Om du vill att vi ska skicka en bekräftelse på ditt barns medlemskap, ber vi dig sätta ett kryss i rutan och skriva den e-post adress som bekräftelsen ska skickas till.
- If you do not wish to receive additional mailings from the LEGO Club please tick here. Si tu ne désires pas recevoir de courrier supplémentaire du Club LEGO, coche cette case. Als je geen verdere post van de LEGO Club wilt ontvangen, kruis dan dit vakje aan.
- Dersom du ønsker å motta annen informasjon fra LEGO Gruppen, setter du et kryss her.

Mail to: / Poster à: **LEGO® Club**
P.O. Box 1157
Enfield, CT USA
06083-1157

Per Post an: **LEGO® Club**
Postfach 14 15
D-36243 Niederaula

Send til: **LEGO® Club Norge**
Postboks 58
1314 Vøyenenga

Mail to: **LEGO® Club**
33 Bath Road
Slough SL1 3UF
United Kingdom

Stuur op naar: **LEGO® Club**
Postbus 40250
3504 AB Utrecht

Skickas till: **LEGO® Club Sverige**
Ubox 841
202 29 Malmö

Poster à: **LEGO® Club**
21 rue de la banque
75 002 PARIS
FRANCE

EN The English language version of the magazine can only be mailed to addresses in the US, Canada, the UK, and Republic of Ireland. Club membership is valid for two years and includes free copies of the LEGO Club Magazine and e-mail newsletters. In the US and Canada please allow up to 6 weeks for delivery of your first magazine. In the UK and Republic of Ireland please allow six to 14 weeks for delivery of your first magazine. By signing this form you consent the LEGO Club to use your child's data for LEGO mailings. The data will only be used for LEGO mailings and will not be sold, rented or otherwise disclosed to any company outside the LEGO Company except for companies acting as our agents to help us provide services requested by the child. This coupon is valid for one free membership per person, group or organization. Photocopied coupons are accepted. **FR** La version française du magazine peut être postée uniquement au Canada. L'abonnement est valide pour 2 ans et inclut des exemplaires gratuits du Magazine LEGO. Aux E.-U. et au Canada, allouer 6 semaines pour la livraison initiale. En remplissant ce formulaire, vous consentez à ce que LEGO utilise les informations de votre enfant pour des envois postaux de LEGO. L'information sera utilisée uniquement pour des envois postaux par LEGO et ne sera en aucun cas, vendue, louée, échangée ou divulguée à d'autres compagnies autres que la compagnie LEGO, à l'exception des compagnies affiliées qui nous procurent des services auxquels l'enfant en a fait la demande. Formulaires photocopiés acceptés. **DE** Mit der folgenden Unterschrift erkläre ich, für mein Kind den Beitritt zum kostenlosen LEGO Club, der von der LEGO GmbH, D-85627 Grasbrunn, betrieben wird. Die Mitgliedschaft beinhaltet die Zusendung des LEGO Club Magazins und kann beiderseits jederzeit beendet werden. Mit der Mitgliedschaft im LEGO Club sind keinerlei Verpflichtungen verbunden. Das deutschsprachige LEGO Club Magazin wird nur an Adressen in Deutschland, Österreich und der Schweiz versendet. Eine Anmeldebestätigung kann nur per E-Mail geschickt werden. Das Magazin erscheint fünfmal jährlich. Daher kann die Zustellung des ersten Heftes bis zu drei Monate dauern. Die Mitgliedschaft ist beidseitig jederzeit kündbar, ohne dass Ihnen Kosten entstehen. Sie können der werblichen Nutzung Ihrer Daten jederzeit widersprechen. Kündigung und Widerspruch können Sie telefonisch erklären (00800 / 5346 5555, Anruf gebührenfrei), Kosten für Anrufe aus dem Mobilfunknetz können abweichen) oder an die LEGO GmbH senden. **NL** Het Nederlandse LEGO Club Magazine kan alleen worden gestuurd naar adressen in Nederland. Het lidmaatschap is 2 jaar geldig en geeft recht op toezending van het gratis LEGO Club Magazine en LEGO Club e-mails. Het eerste magazine zal binnen 12 tot 14 weken toegestuurd worden. Het lidmaatschap kan op ieder moment opgezegd worden en kan na 2 jaar gratis worden verlengd, tenzij LEGO met deze activiteit stopt. Uw gegevens worden uitsluitend gebruikt voor mailings van LEGO en zullen niet worden verkocht, verhuurd of op welke wijze dan ook verstrekt aan derden buiten de LEGO Groep, uitgezonderd de organisaties die namens ons optreden om de informatie te sturen waarvoor toestemming is verleend. **NO** Den norske utgaven av magasinet sendes kun til adresser i Norge. Medlemskap i klubben gjelder i 2 år og inkluderer gratisutgaver av LEGO Club Magazine. Påregning minimum opp til seks uker leveringstid for første magasin. Ved å undertegne dette skjemaet, gir du ditt samtykke til at LEGO Club kan bruke opplysningene om barnet ditt i LEGO forsendelser. Dataene vil utelukkende bli brukt i LEGO forsendelser og vil ikke bli solgt, utleid eller på annen måte gjort tilgjengelig for selskaper utenfor LEGO gruppen, unntatt selskaper som er våre agenter og som hjelper oss å tilby tjenestene barnet ettertar. Dette skjemaet gjelder for ett gratis medlemskap per person, gruppe eller organisasjon. **DK** Den svenske versionen av tidningen kan endast skickas till adresser i Sverige. Club-medlemskapet är giltigt i 2 år och innefattar gratis exemplar av LEGO Club Magazine. Vänligen räkna med minimum 6 veckor för leverans av din första tidning. Genom att skicka in ditt här formuläret godkänner du att LEGO Club använder barnets uppgifter för LEGO utskick. Uppgifterna kommer bara att användas för LEGO utskick och kommer inte att säljas, hyras ut eller vidarebefordras till något företag som inte tillhör LEGO Gruppen, med undantag av företag som agerar som våra ombud för att tillhandahålla tjänster som barnet har begärt. Den här kupongen gäller för ett gratis medlemskap per person, grupp eller organisation. **FR** En complétant ce bulletin d'adhésion, vous acceptez que LEGO Club utilise les données relatives à votre enfant pour l'envoi de courriers concernant LEGO. Ces données seront uniquement utilisées pour l'envoi d'information concernant LEGO et ne seront ni vendues, ni louées, ni utilisées par d'autres sociétés que le groupe LEGO, à l'exception des sociétés agissant pour le compte de LEGO en tant que sous-traitant de services divers. L'abonnement au LEGO Club est valable pour une période de 2 ans. Il inclut l'envoi par courrier du magazine LEGO Club et par email des newsletters. Un délai de 6 à 14 semaines est à prévoir pour la réception de votre premier magazine. Ce bulletin d'adhésion gratuit est valable pour l'inscription d'une seule personne. Les photocopies sont acceptées. ATTENTION! Le bulletin d'adhésion doit être rempli et signé par un parent ou un tuteur.

Parent's signature • Signature d'un parent ou d'un tuteur •
Unterschrift Erziehungsberechtigte/r • Handtekening ouders •
Foreldres/foresattes underskrift • Förälders/formyndares underskrift

Date
Datum
Date

LEGO and the LEGO logo are trademarks of the LEGO Group. ©2012 The LEGO Group. 6002473



NINJAGO

Masters of Spinjitzu



9456



VS



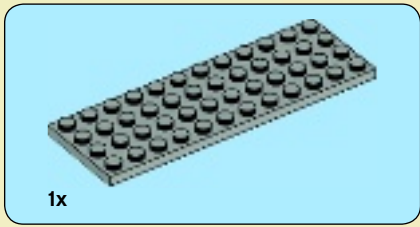
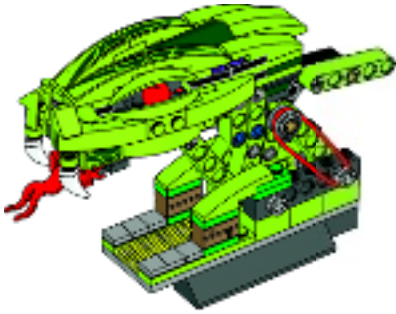

1

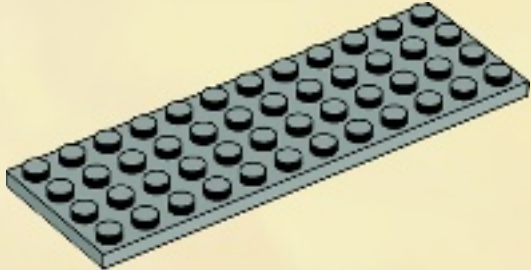

2



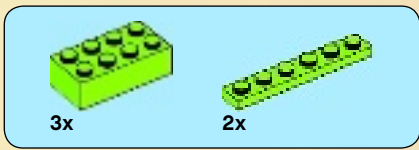

3

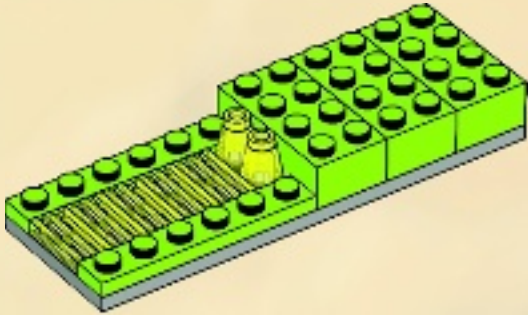

4

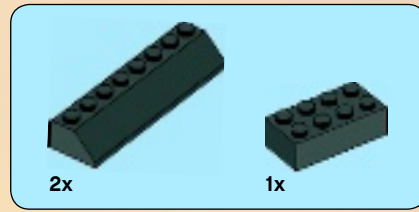
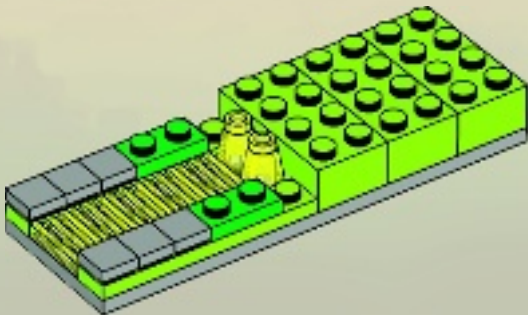

5

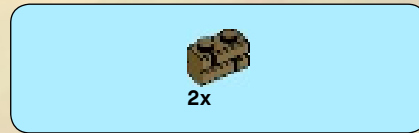
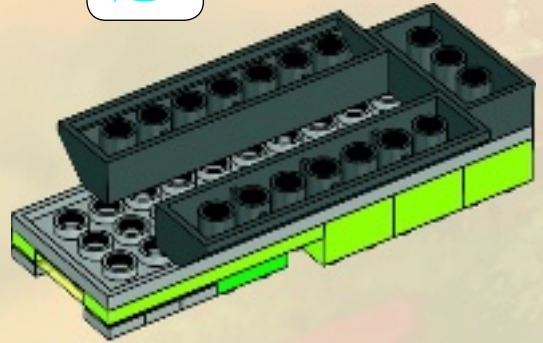
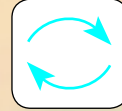

6

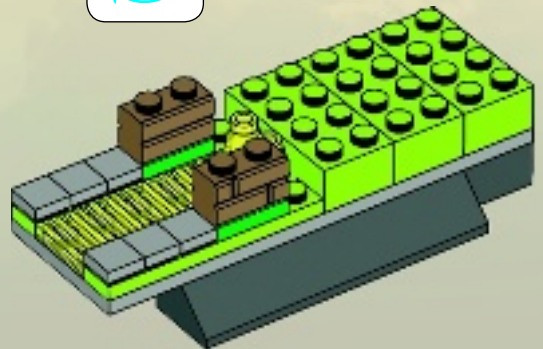
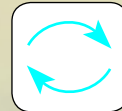

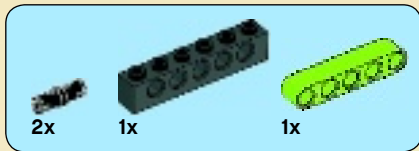

7

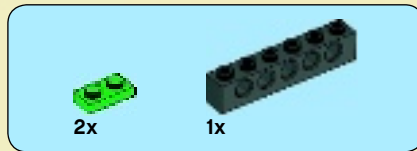
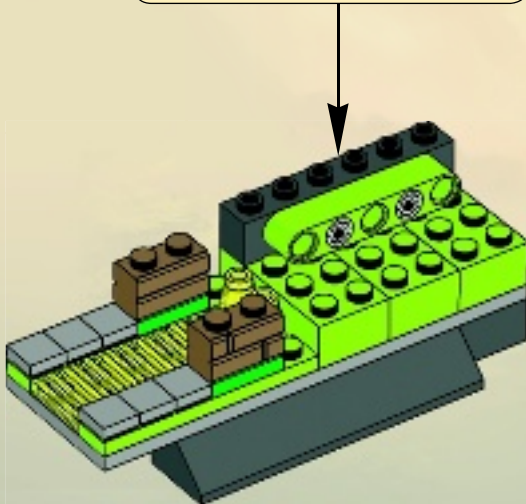
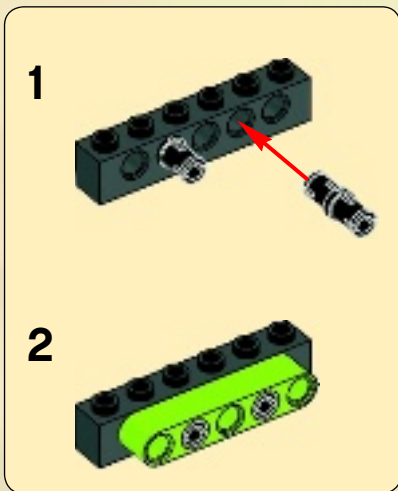

8

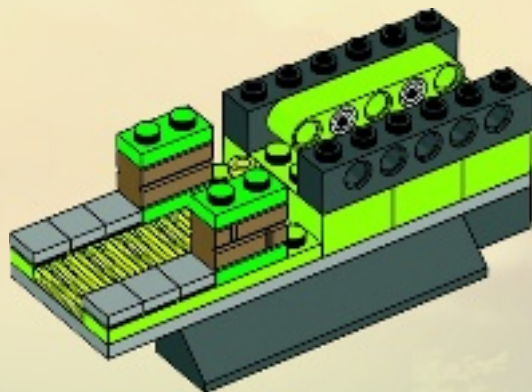

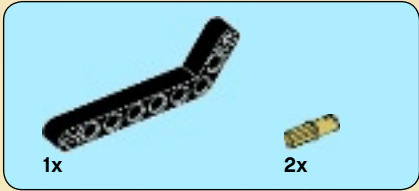

1

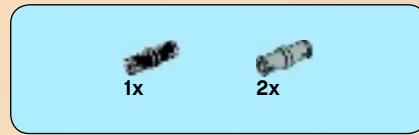
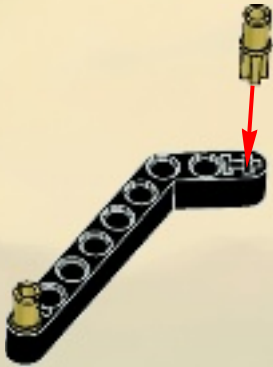

1x

2x

2

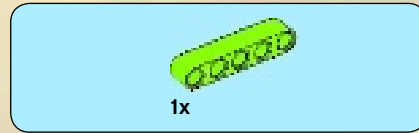

1x

3

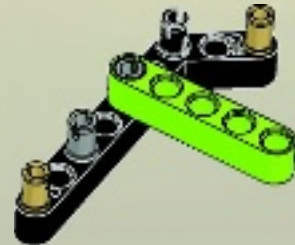



1x

4

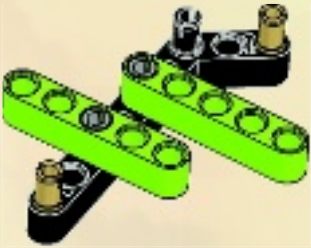

1x

5

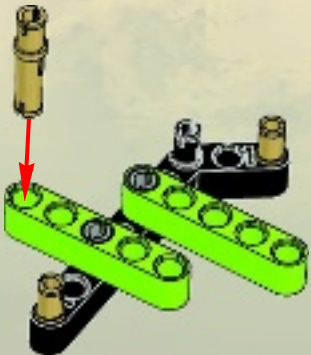

1x

6

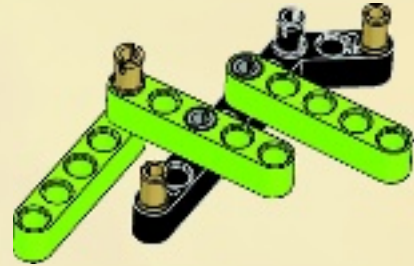

2x

7



2x

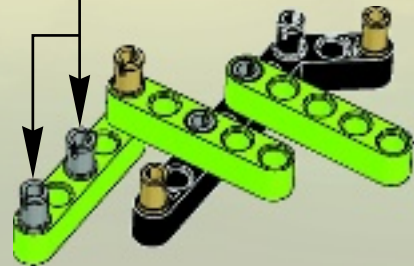

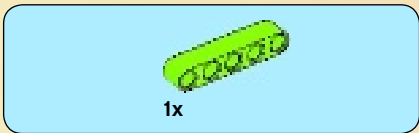

8

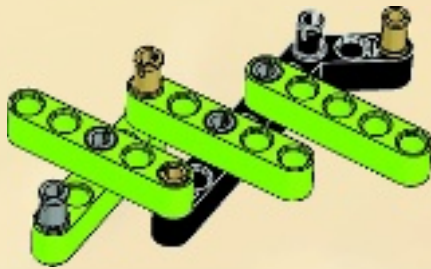

10

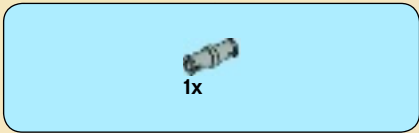
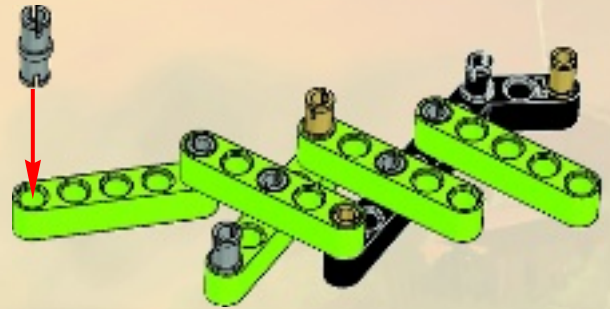

9

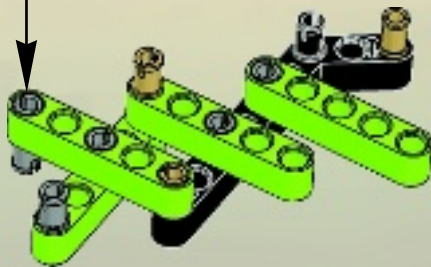

11

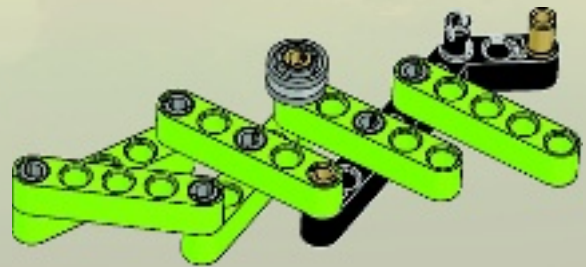

12

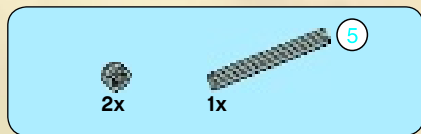
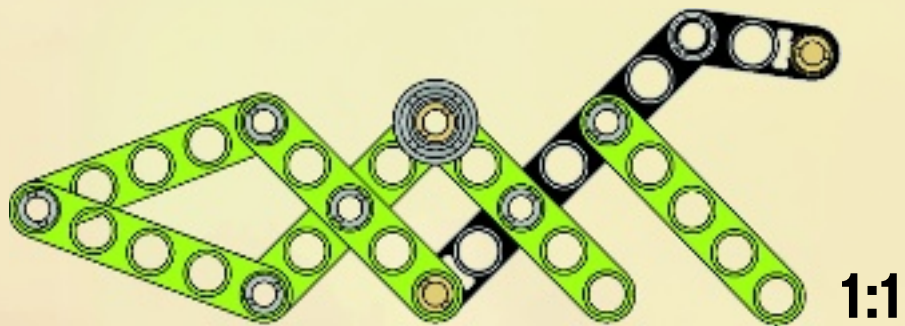

13

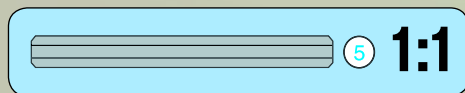
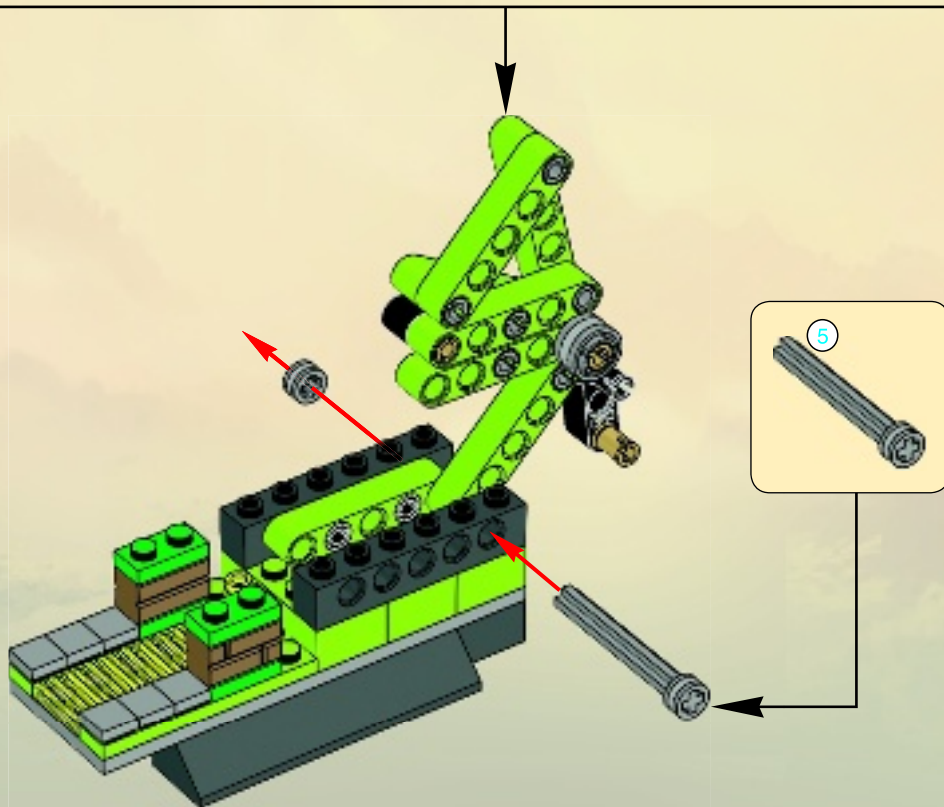

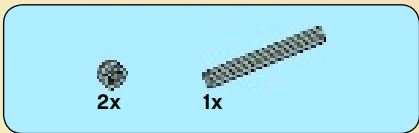

14

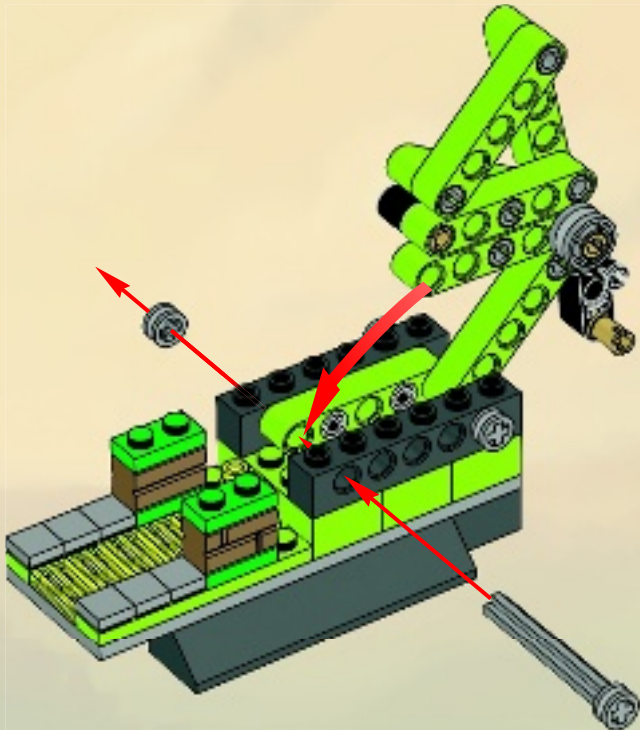

15

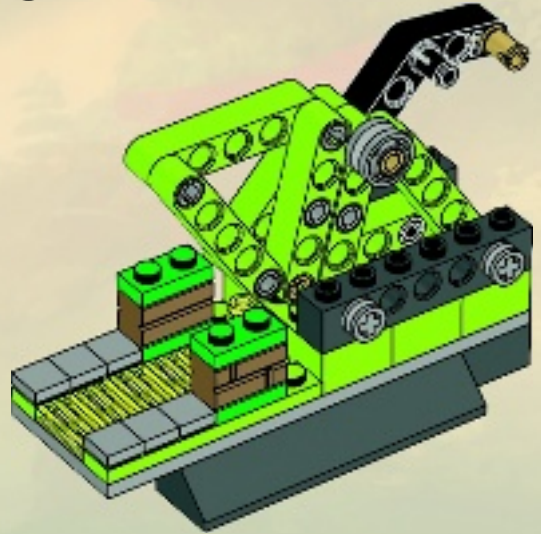

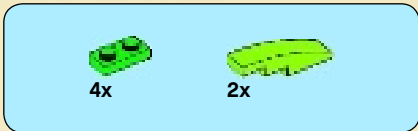

16

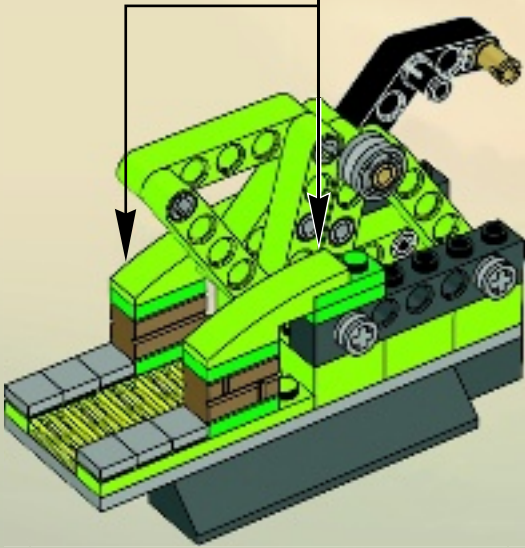
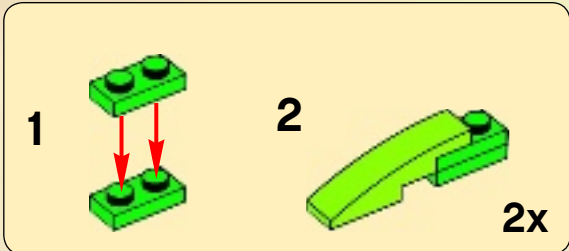

17

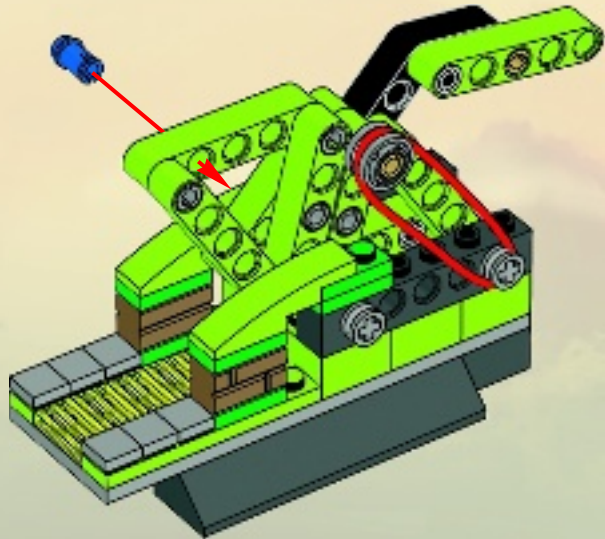



18

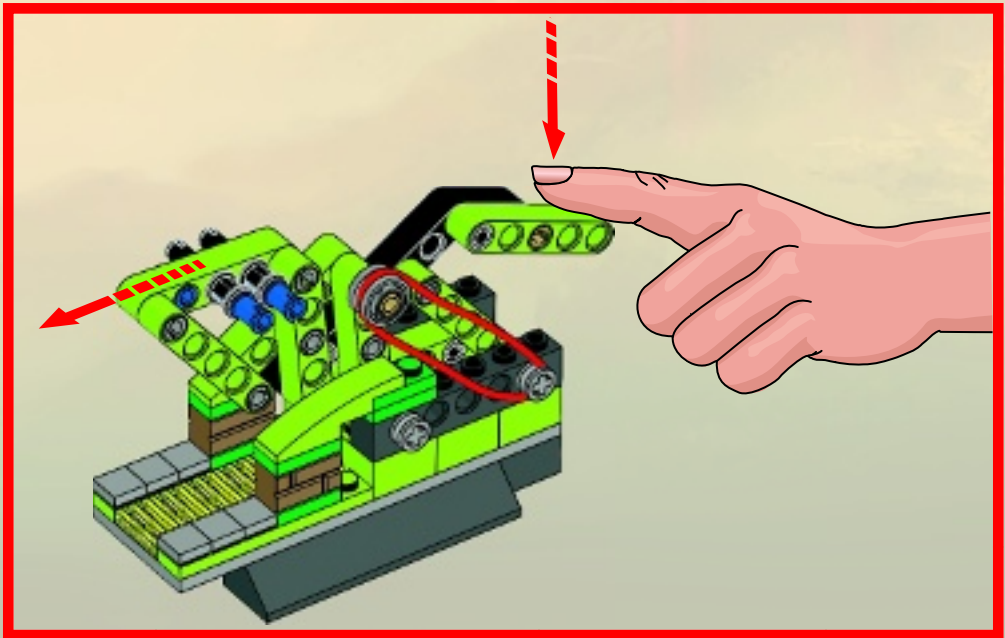
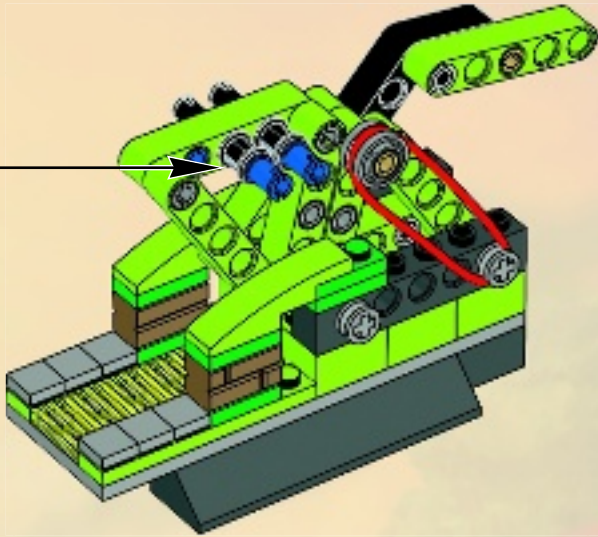
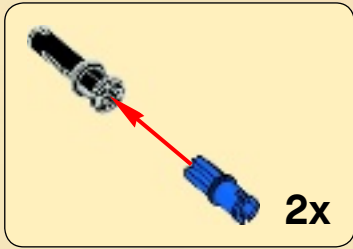

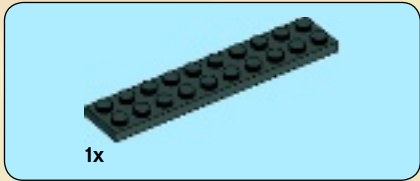

1

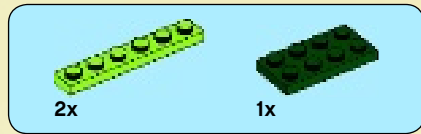

2



3

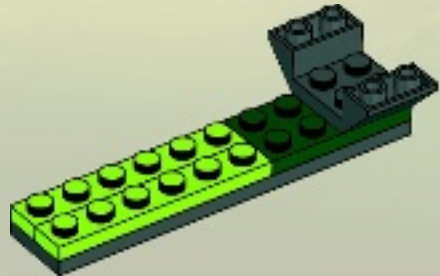

4x



2x

4

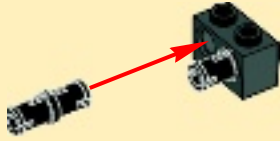

2x

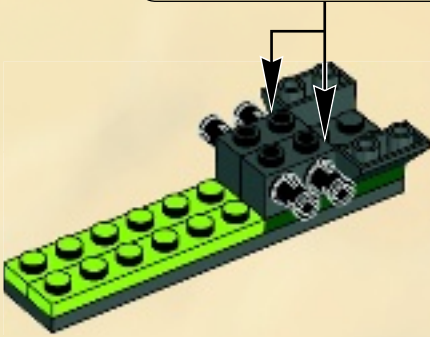

2x



2x

5

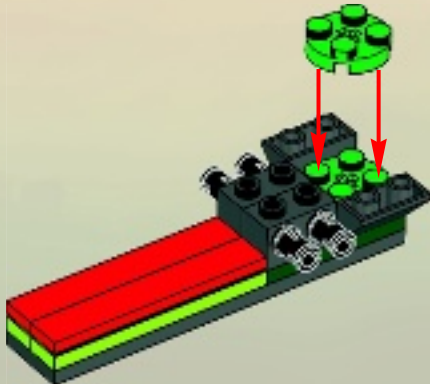

1x

6

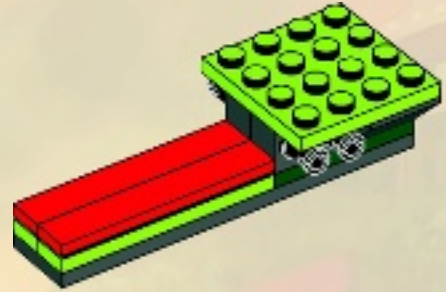

1x



1x

7

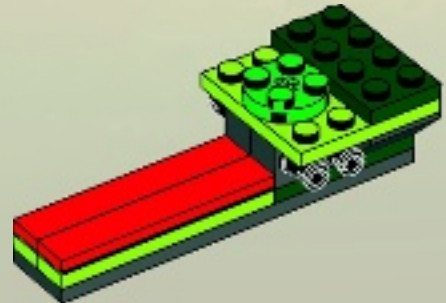

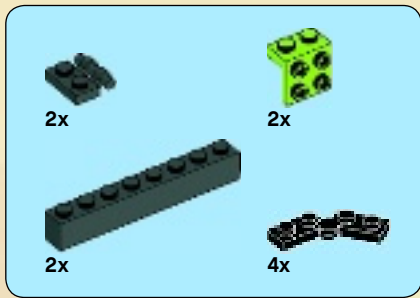

8

1

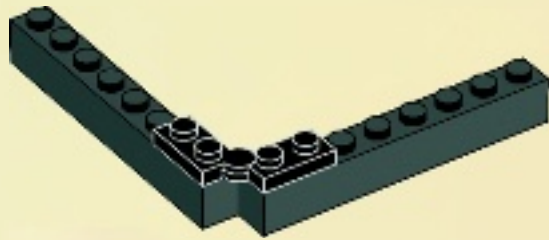

2



3

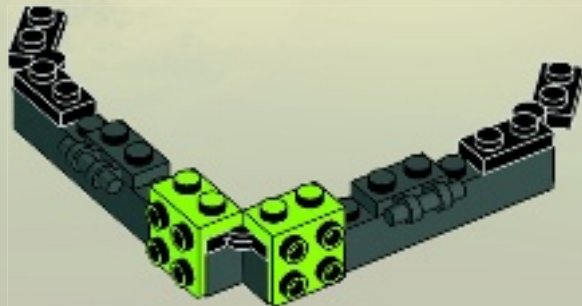

4



5

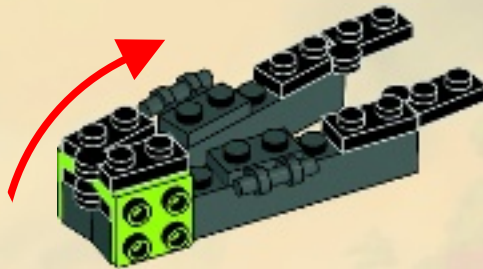



1x

9

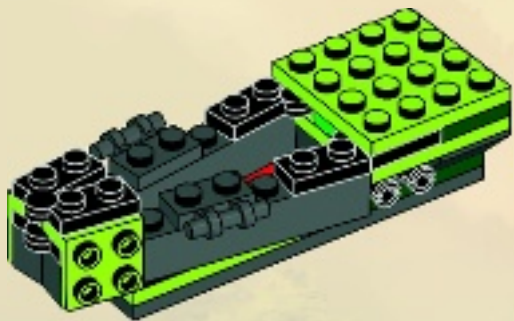

2x



2x

10

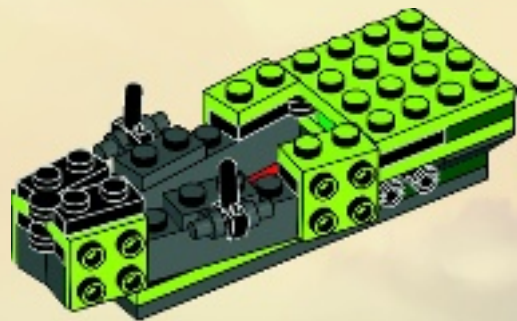

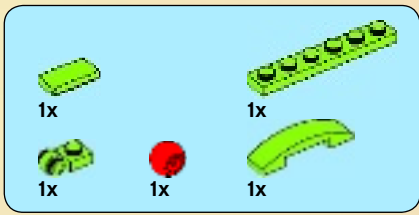

11

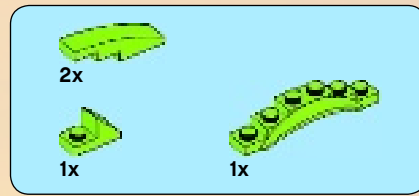
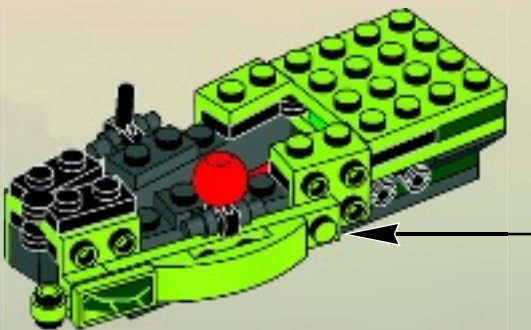
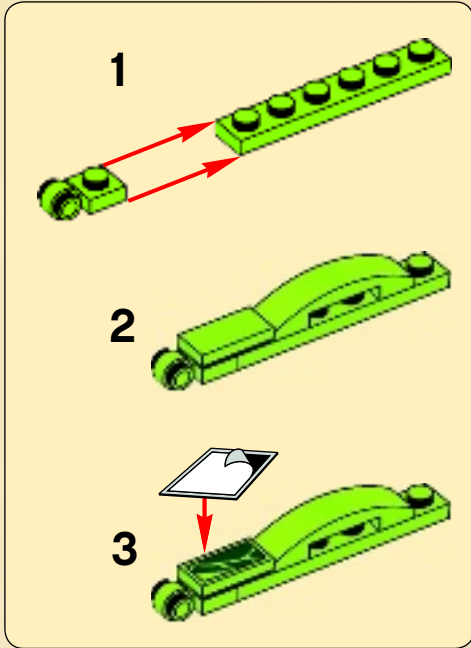

12

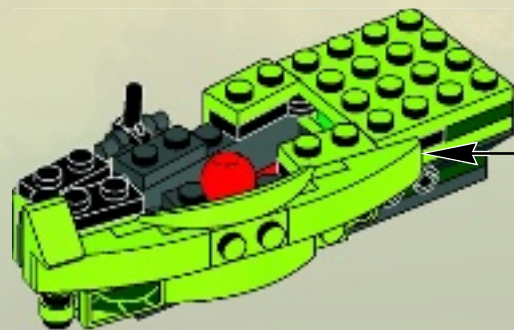
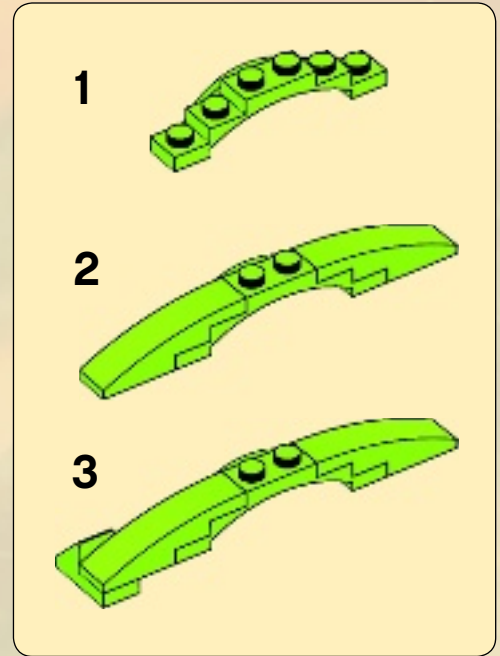

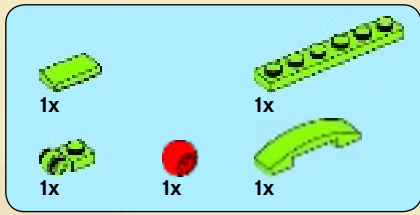

13

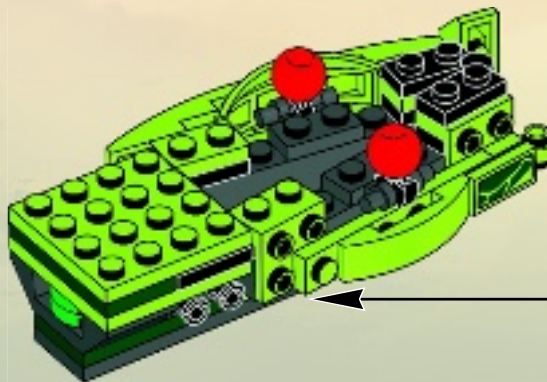
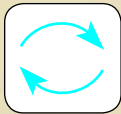
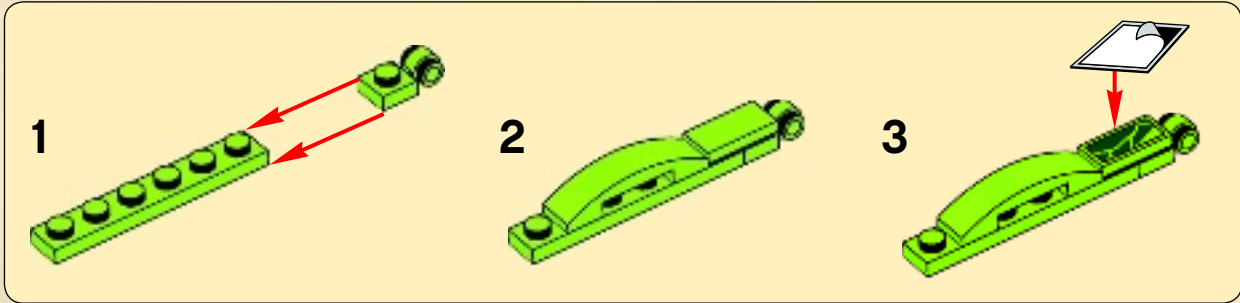



NINJAGO

Masters of Spinjitzu



NINJAGO.COM



9445

9442

9443

9446

9567
9552

9564

9563

9561

9552

9566

9566

9441
9558
9579



9444

9441
9558

9441
9444
9446

9579

9562
9440

9444
9566

9551

9440
9445
9446
9553
9558

9562

9558

9563
9567

9564



- 9551
- 9443
- 9446
- 9446
- 9443
- 9446
- 9552
- 9444
 9579
- 9561
 9553
- 9442
 9558
- 9579
 9558



- 9562
- 9564
- 9443
- 9442
 9445
- 9446
- 9446
 9551
 9558
 9561
- 9558
 9579
- 9579
- 9567
- 9553
- 9440
- 9445



NINJAGO

Masters of Spinjitzu



9446

9445

9443

9444

9446

9445

9444

9443

9442

9441

9440

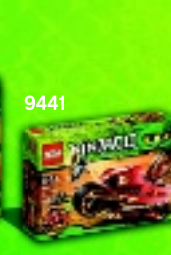

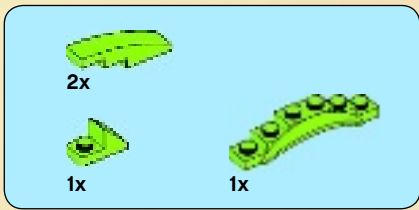

14

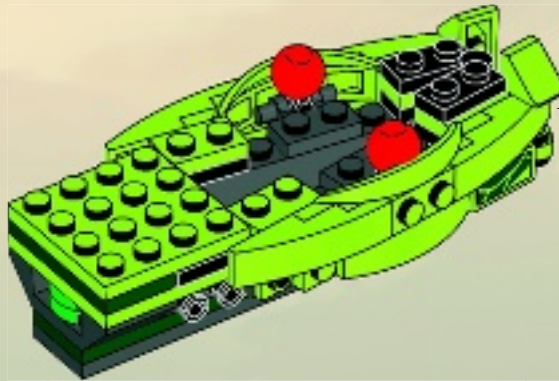
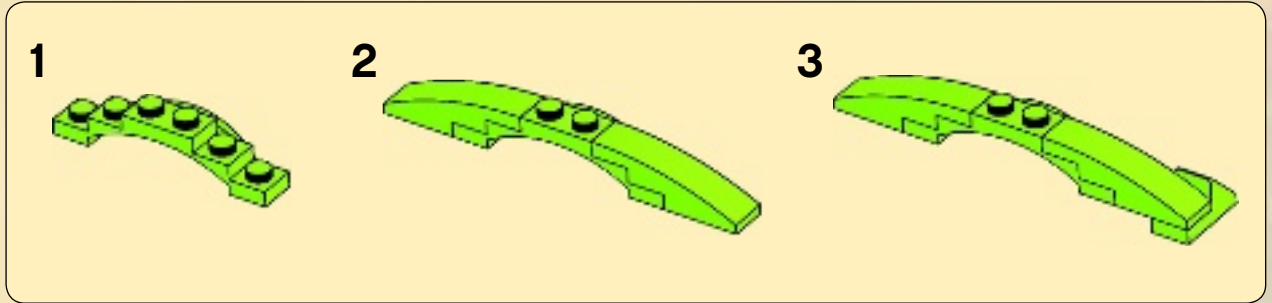



2x



1x

15

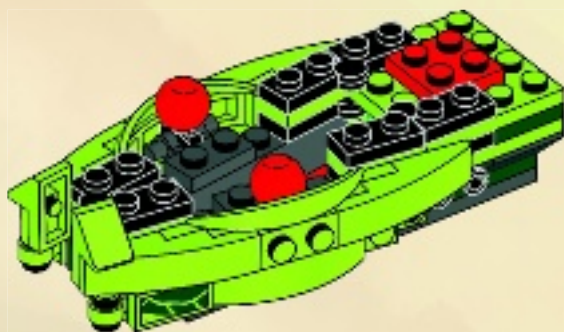
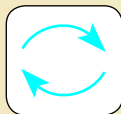

4x

16

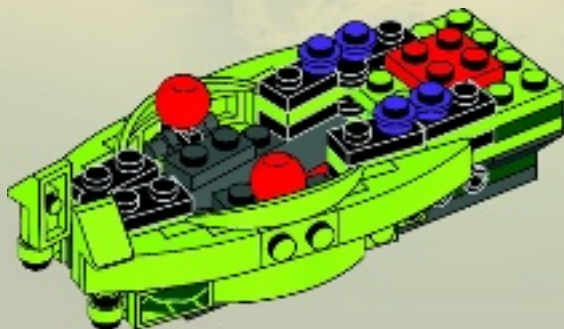

1x

17

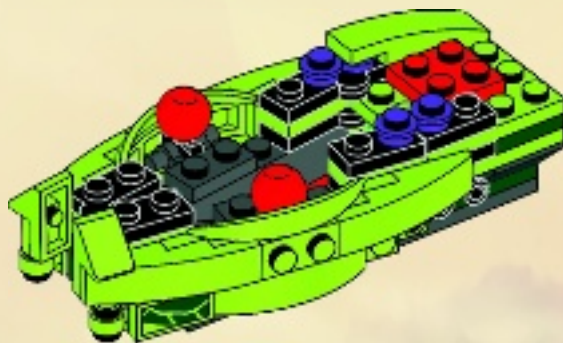

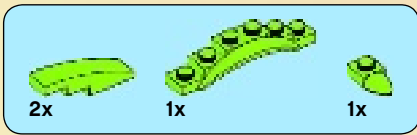

18

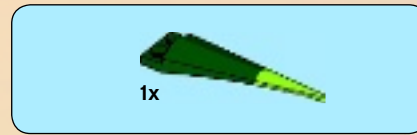
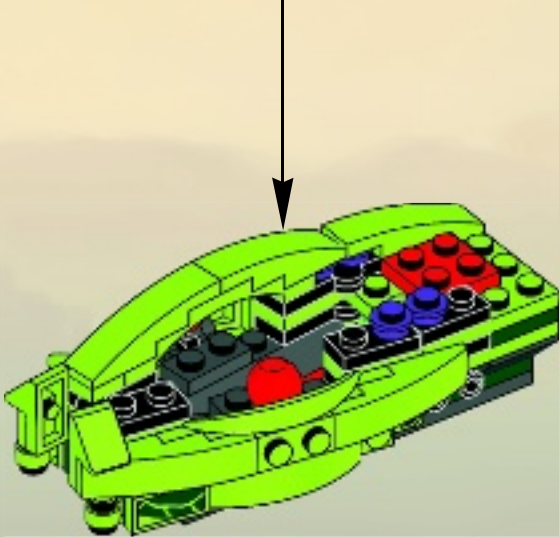
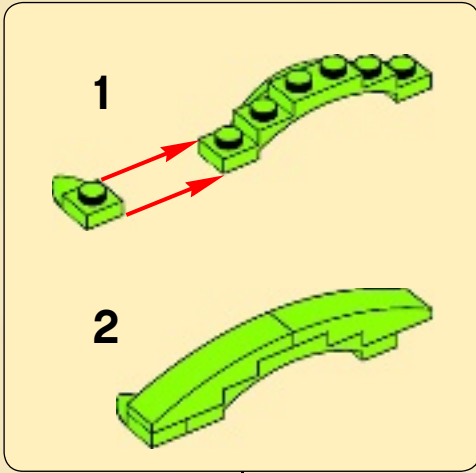

19

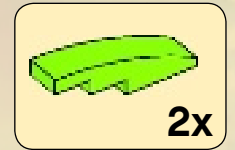
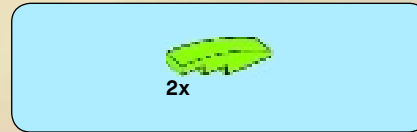
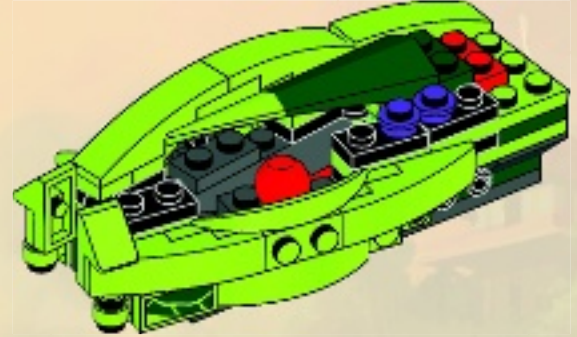

20

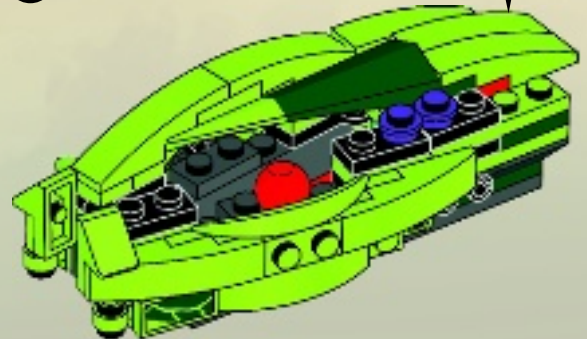

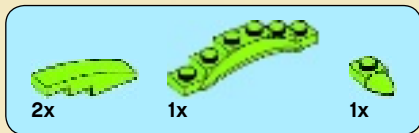

21

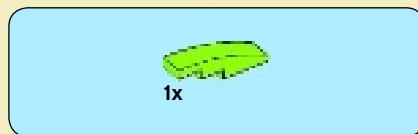
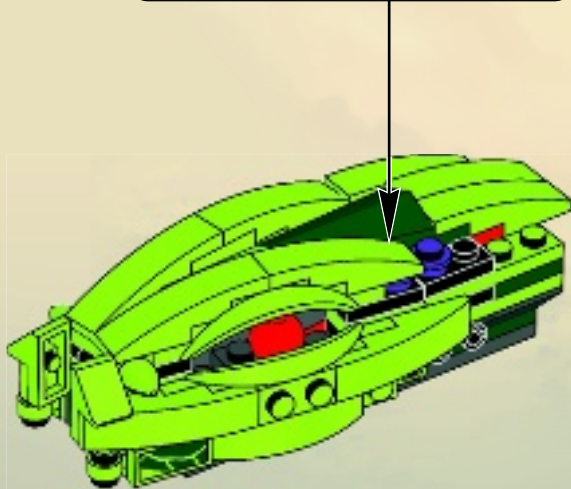
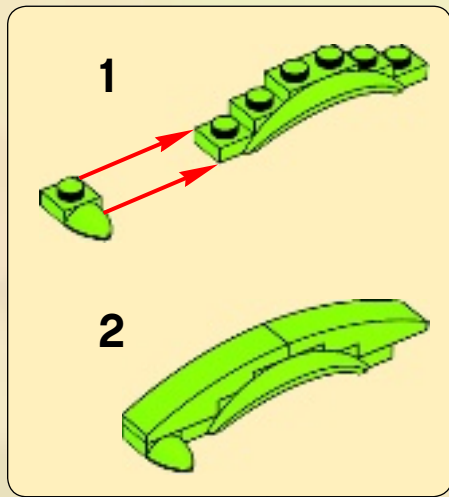

22

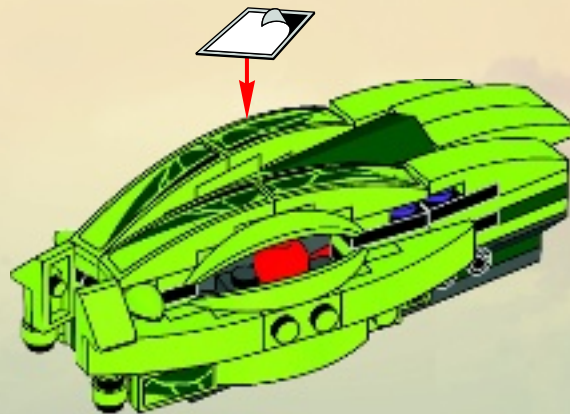



2x

23

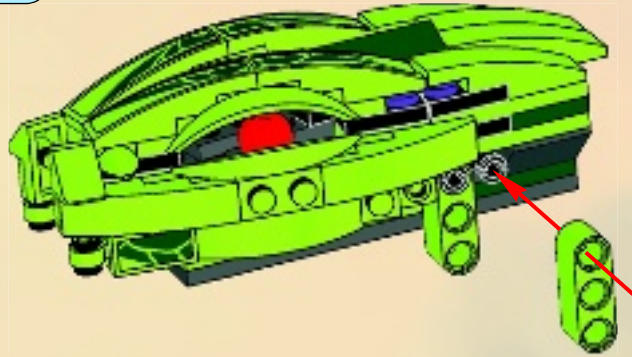

24

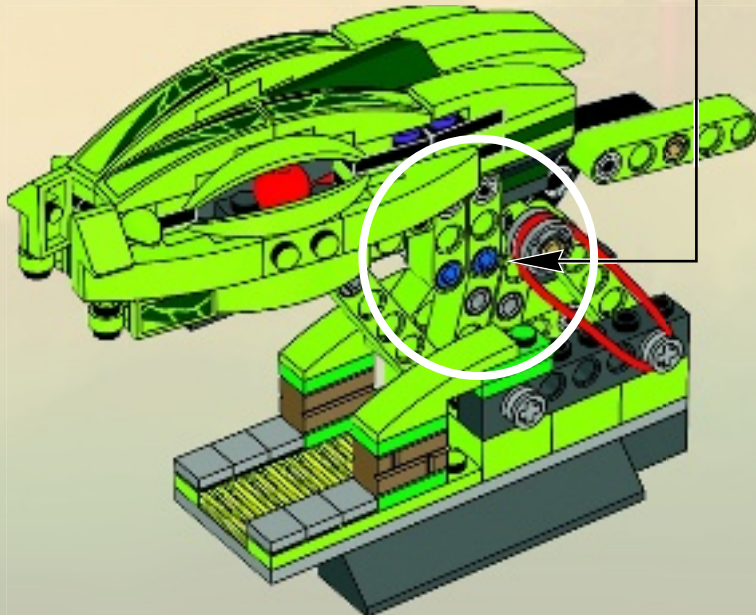



2x

25

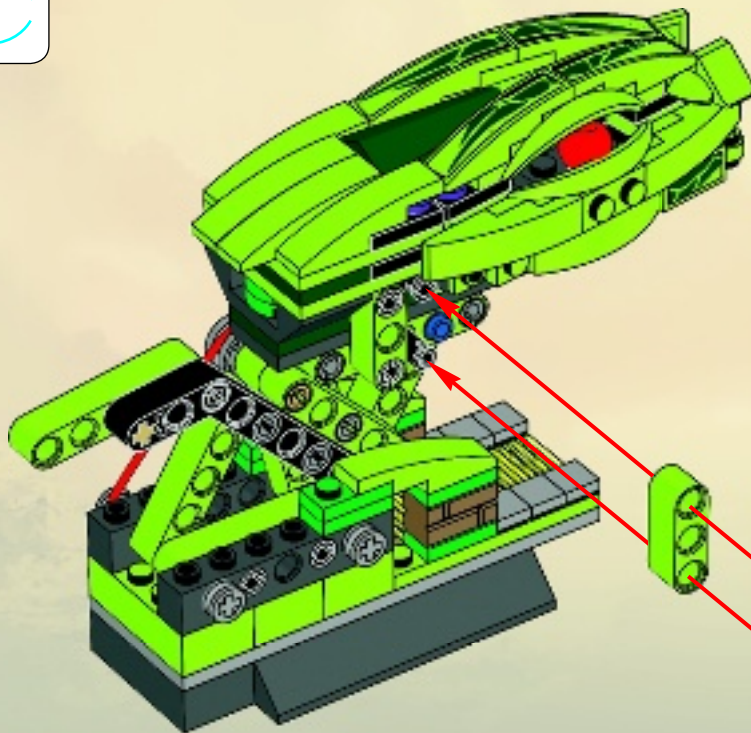
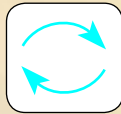



2x

26

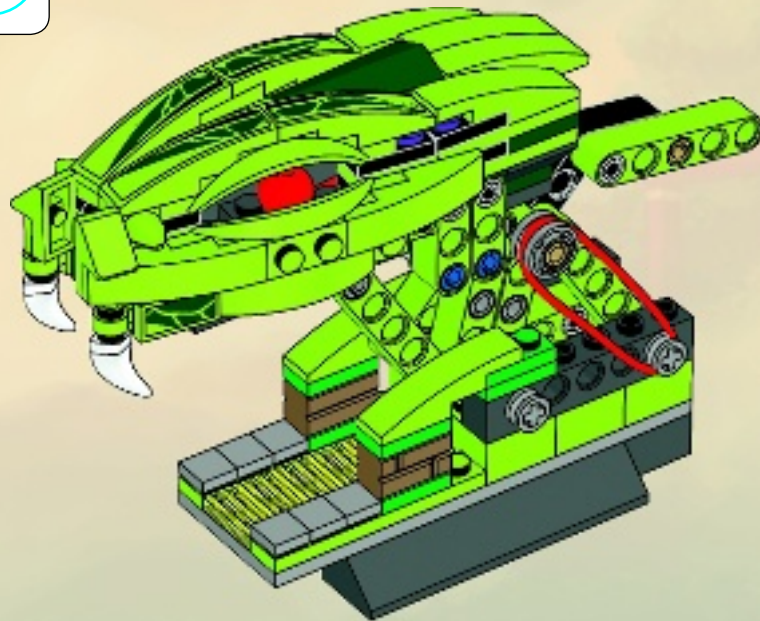
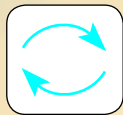



27

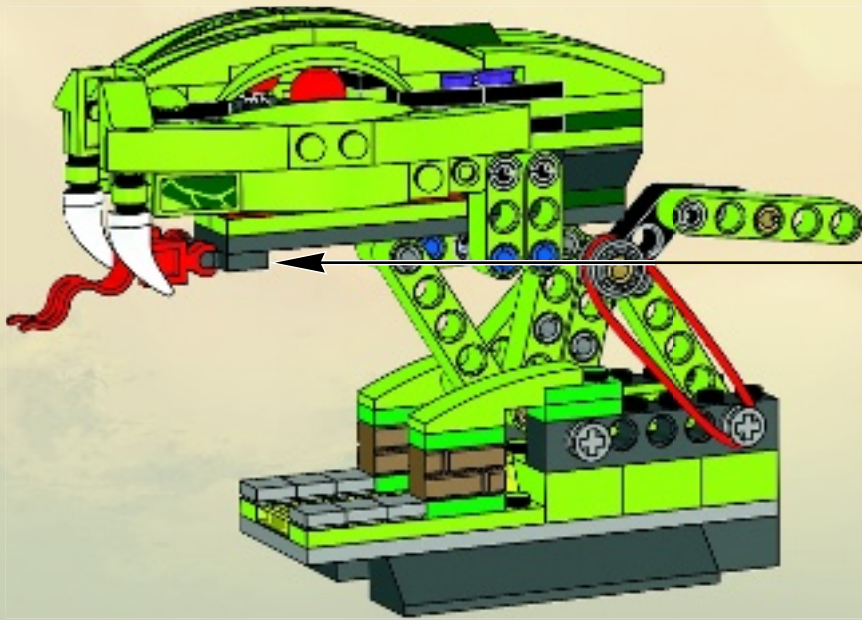
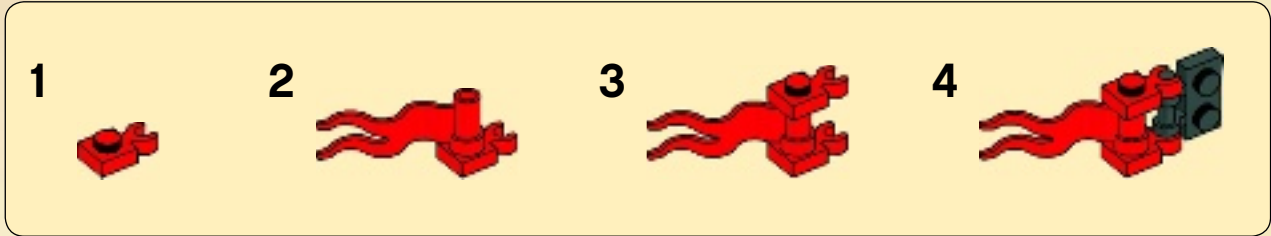

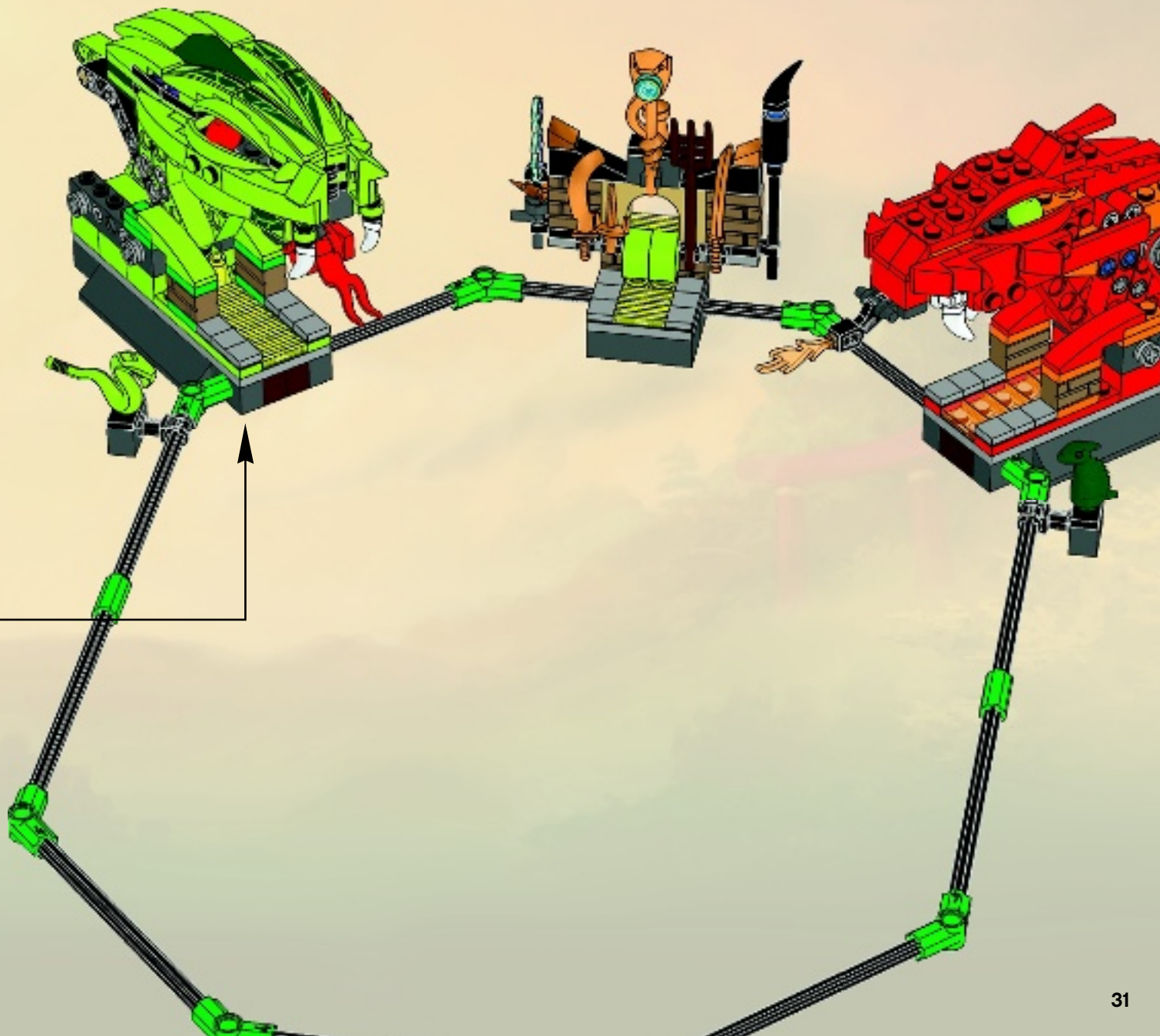





Customer Service
Kundenservice
Service Consommateurs
Servicio Al Consumidor

www.lego.com/service or dial



: 00800 5346 5555

: 1-800-422-5346



8x
4661486



2x
4624381



1x
4514700



10x
4646577



1x
4647012



1x
4658071



2x
4586057



1x
4619469



2x
4567338



5x
4541710



1x
4261397



4x
4211252



1x
4624905



1x
4243797



1x
4211425

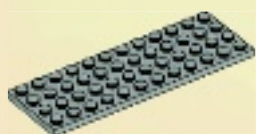

2x
4211401



18x
4211415



1x
4645539



1x
4646541



1x
4650678



8x
4211573



2x
4211758



12x
4211807



4x
4211639



3x
4211085



2x
4211099



1x
4265794



8x
4210935



4x
4210762

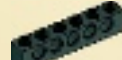

4x
4210917



1x
4211076



4x
4210907



2x
4210678



6x
4210660



1x
4566028



1x
4649635



1x
4612797



4x
4566522



1x
4654171



1x
4529247



2x
4587002



1x
4649422



1x
4626501



1x
4610763



1x
4600519



1x
4614404



1x
4646828



1x
4646866



1x
4549898



1x
4654164



1x
4654058



1x
4654052

5

CUSTOMIZE YOUR SPINNERS
PERSONNALISE TES TOUPIES
PERSONALIZA TUS SPINNERS

RATTLA

COLE ZX

9579

ARENA INCLUDED
ARÈNE INCLUSE
ARENA INCLUIDA



9551



9552

9553

CUSTOMIZE WITH BOOSTER PACKS

PERSONNALISE GRÂCE AUX BOOSTERS

PERSONALÍZALO CON PACKS DE REFUERZO

NINJAGO.COM

COLE ZX VS RATTLA

LASHA

KENDO ZANE

SHARPA

SAMURAI X

HAI ZX

FANG-SUEI

9579

9562

9563

9564

9566

9561

9567



NINJAGO

Masters of Spinjitzu



KENDO ZANE
9563 - 9446



KENDO KAI
9558



KENDO COLE
9551



COLE ZX
9579 - 9444



ZANE ZX
9440
9445



JAY ZX
9563
9442
9445



SAMURAI X
9566



LLOYD GARMADON
9552 - 9443



FANG-SUEI
9567 - 9443



FANGDAM
9445



LASHA
9562



RATTLA
9579 - 9441



SNAPPA
9564 - 9442





NINJAGO

Masters of Spinjitzu



**CUSTOMIZE YOUR SPINNERS
PERSONNALISE TES TOUPIES
PERSONALIZABLE TUS SPINNERS**





NINJAGO

Masters of Spinjitzu



NINJAGO.COM



WIN!

Go to www.LEGOsurvey.com/product
to fill out a survey for a chance
to win a cool LEGO® Product.
No purchase necessary.
Open to all residents where not prohibited.



www.LEGO.com



www.LEGOsurvey.com/product

GEWINNE! WIN!

Nimm an der Umfrage auf
www.LEGOsurvey.com/product
teil und hab die Chance ein cooles
LEGO® Produkt zu gewinnen!

Die Teilnahme am Gewinnspiel führt zu keinerlei
Kaufverpflichtungen. Teilnahme in allen nicht
ausgeschlossenen Ländern möglich.

Ga naar www.LEGOsurvey.com/product,
vul een enquêteformulier
in en maak kans op een
cool LEGO® product.

Geen aankoopverplichting.
Iedereen mag deelnemen, uitgezonderd
ingezetenden van landen waar een
enquêteverbod geldt.

GAGNE! 当てよう!

Visite www.LEGOsurvey.com/product
pour répondre à un
questionnaire et avoir une chance de
gagner un produit LEGO® très cool!

Aucune obligation d'achat.
Ouvert à tous les résidents des pays
autorisés.

www.LEGOsurvey.com/product にアクセスして、
アンケートにご記入ください。当選者にはレゴ®
製品を差し上げます。

お買い上げの必要はありません。

禁止されていない限り、すべての皆様にご利用いただけます。