



LEGENDS OF
CHIMA™

70108



1



2



3



4



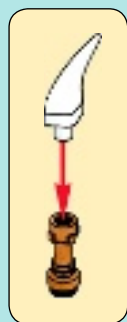
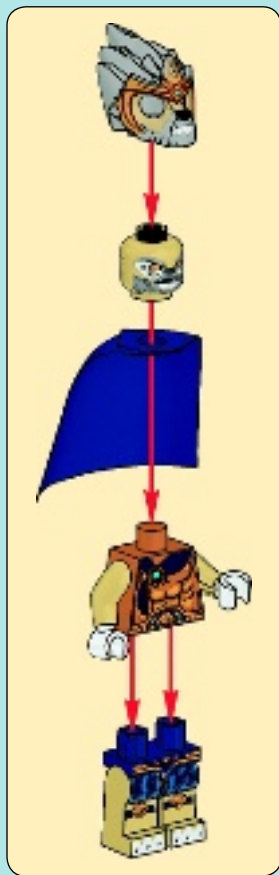

1



2



3





1

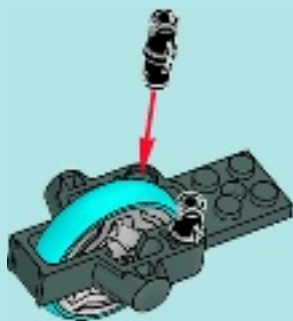

2





3



6

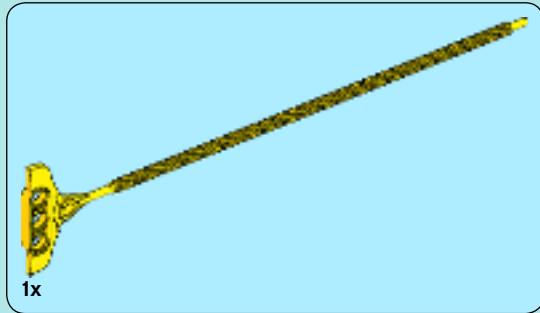

4

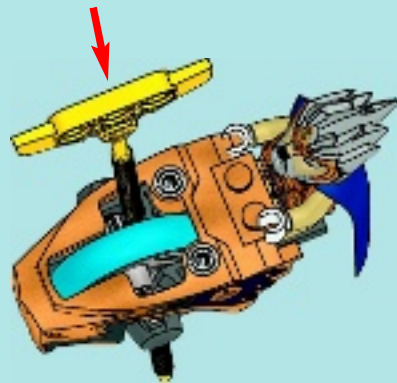



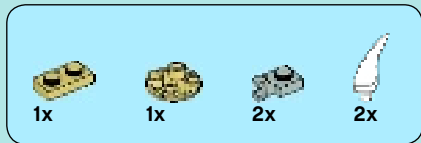

1

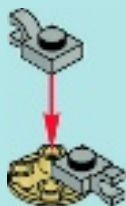

2



3



4





2x



1x

1

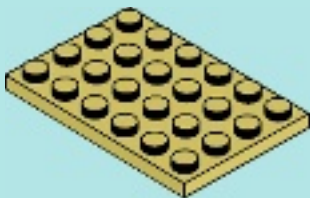

2x

2

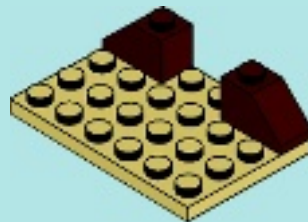

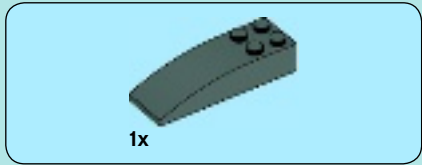

3

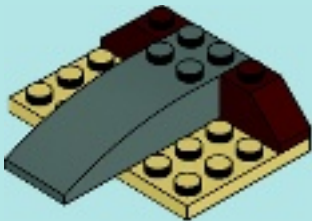

4

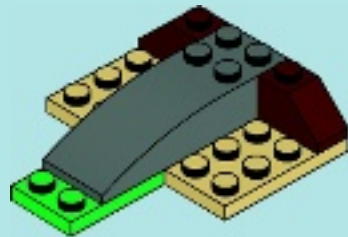



2x

5



3x

6

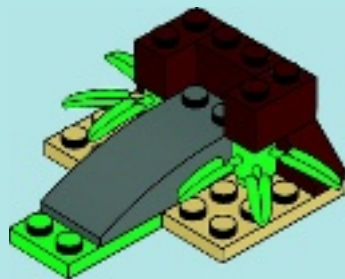



1x



1x

7

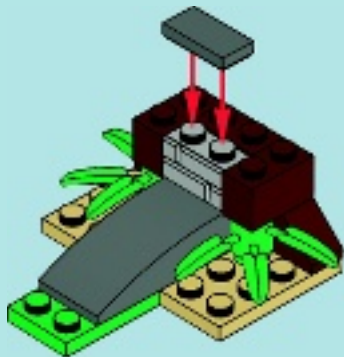

2x

8

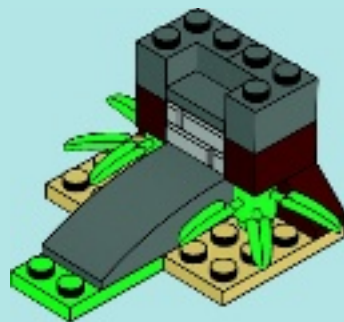



1x



2x

9

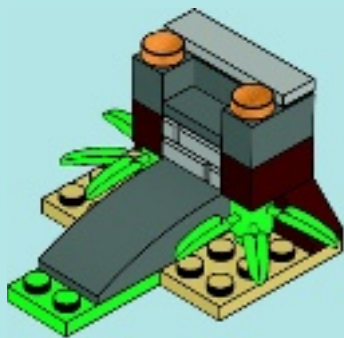

2x

10

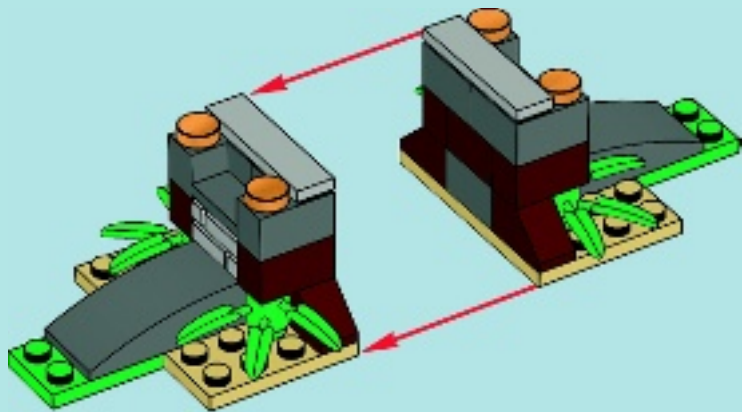

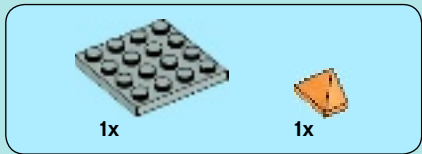

1

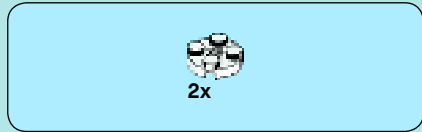

2



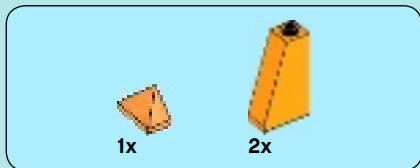

3



4





2x

5



2x

6

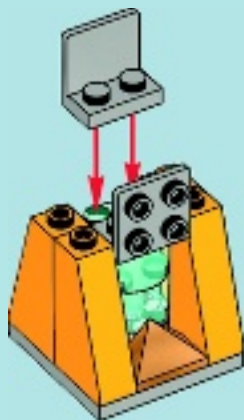



1x

7

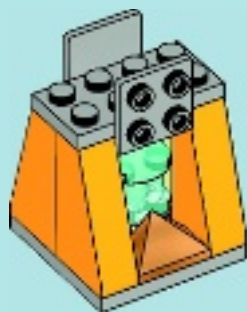

4x



2x

8





1x



2x

9



2x

10

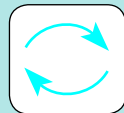

11

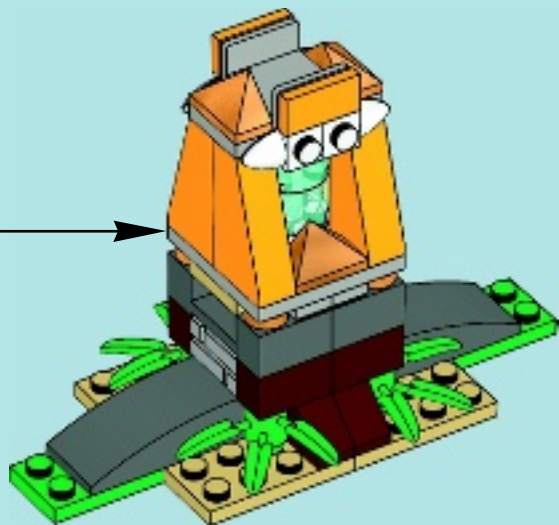

1





1x

2



4x

3





4x

4



1x

5





1x

6



7

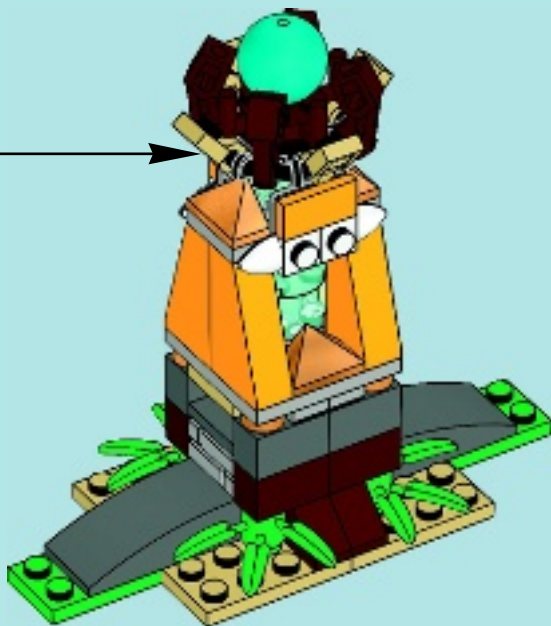



2x
403201



1x
4129836



3x
4566256



4x
4224792



2x
4114001



4x
4520947



1x
4278422



1x
6021694



1x
6021598



1x
6020778



3x
4113917



1x
6018805



2x
4121715



2x
302128



4x
4114348

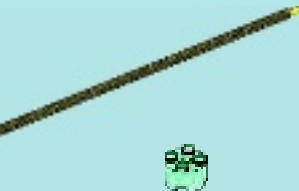

3x
4178398



1x
4163917



6x
6019570



1x
4586291



1x
4625528



2x
4622062



4x
6023161



6x
4211149



4x
4211199



1x
4648118



4x
6006740



1x
6024162



2x
6000066



1x
4211395



1x
4243797



2x
4541978



2x
4654580



1x
4211413



2x
4211356



1x
6023163



1x
6021353



2x
4210873



4x
4211109



2x
4211052



1x
6022549



4x
4649422



4x
4295174



2x
6003147



1x
6036017



1x
4623298



Customer Service

Kundenservice

Service Consommateurs

Servicio Al Consumidor

LEGO.com/service or dial



: 00800 5346 5555

: 1-800-422-5346

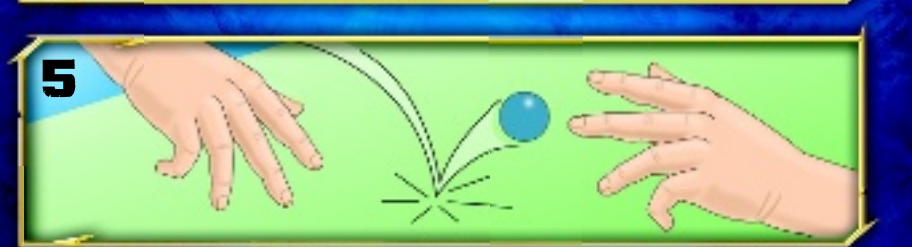





1. **Tribe** 2. **Battle Powers:** 🐉 Instinct 🐉 Speed 🐉 Courage 🐉 Strength
 3. **CHI Bonus:** When you flip a card, you may pay 1 CHI crystal to add the CHI bonus to any connected battle power.



1. **Stamm** 2. **Kräfte:** 🐉 Instinkt 🐉 Geschwindigkeit 🐉 Mut 🐉 Stärke
 3. **CHI-Bonus:** Wenn du eine Karte aufdeckst, kannst du einen CHI-Kristall zahlen, um den CHI-Bonus zu erhalten. Dieser Bonus gilt nur für eine mit dem CHI verbundene Kraft.



1. **Tribu** 2. **Pouvoirs:** 🐉 Instinct 🐉 Vitesse 🐉 Courage 🐉 Force
 3. **Bonus CHI :** Quand tu retournes une carte, tu peux ajouter des points Bonus à tout pouvoir relié au CHI, contre le don d'un cristal CHI.



1. **Tribù** 2. **Poteri :** 🐉 Istinto 🐉 Velocità 🐉 Coraggio 🐉 Forza
 3. **Bonus :** Quando scopri una carta, puoi pagare 1 cristallo CHI per aggiungere un CHI bonus al potere scelto per la battaglia.



1. **Stam** 2. **Krachten:** 🐉 Instinct 🐉 Snelheid 🐉 Moed 🐉 Spijkracht
 3. **CHI bonus:** Als je een kaart omdraait, mag je 1 CHI kristal betalen om de CHI bonus toe te voegen aan een daarmee verbonden kracht.



1. **Tribu** 2. **Poderes de combate:** 🐉 Instinto 🐉 Velocidad 🐉 Valentía 🐉 Fuerza
 3. **Bonificación de CHI:** Al dar la vuelta a una carta, puedes pagar 1 cristal de CHI para asignar la bonificación de CHI a cualquier poder de combate conectado.



1. **Stamme** 2. **Kampevner:** 🐉 Instinkt 🐉 Hastighed 🐉 Mod 🐉 Styrke
 3. **CHI-bonus:** Når du vender et kort, kan du betale én CHI-kristal for at føje CHI-bonusen til en forbundet kampevne.



1. **Heimo** 2. **Taisteluvoimat:** 🐉 Vaisto 🐉 Nopeus 🐉 Rohkeus 🐉 Voima
 3. **CHI-bonus:** Kun käännät kortin, sinun on maksettava 1 CHI-kristalli lisätäksesi CHI-bonusen johonkin kytketyistä taisteluvoimista.



1. **Stam** 2. **Stridskrafter:** 🐉 Instinkt 🐉 Snabbhet 🐉 Mod 🐉 Styrka
 3. **CHI-bonus:** När du vänder på ett kort kan du betala 1 CHI-kristall för att addera CHI-bonusen till en av de anslutna stridskrafterna.



1. **Tribo** 2. **Poderes de combate:** 🐉 Instinto 🐉 Velocidade 🐉 Coragem 🐉 Força
 3. **Bônus CHI:** Quando viras uma carta, podes pagar 1 cristal CHI para acrescentares o bônus CHI a qualquer poder de combate associado.



1. **Φυλή** 2. **Πολιμικές ικανότητες:** 🐉 Ενστικτο 🐉 Ταχύτητα 🐉 Θάρρος 🐉 Δύναμη
 3. **Εξτρα Βαθμίοι CHI:** Όταν γυρίσεις μια κάρτα, μπορείς να δώσεις 1 κρύσταλλο CHI για να προσθέσεις τους εξτρα βαθμίους CHI σε οποιαδήποτε πολιμική ικανότητα συνδέεται με αυτούς.



1. **種族** 2. **バトルパワー :** 🐉 本能 🐉 スピード 🐉 勇気 🐉 強さ
 3. **チのボーナス :** カードを取って表を向けた時に、チのクリスタルを1個使えば、チのボーナスの絵とつながっているバトルパワーにチのボーナスを追加できる。



1. **部落** 2. **战斗能量:** 🐉 本能 🐉 速度 🐉 勇气 🐉 力量
 3. **奖励真气:** 翻开卡片时, 你可以消费一个真气水晶, 将相应真气添加到任何相连的战斗能量中。



1. **종족** 2. **배틀 파워:** 🐉 직감 🐉 스피드 🐉 용기 🐉 힘
 3. **키보너스:** 카드한장을 뒤집고 키보너스 1개를 지불하면 관련된 배틀 파워에 키보너스를 추가할 수 있습니다.



1. **Klan** 2. **Боевые способности:** 🐉 Интуиция 🐉 Скорость 🐉 Храбрость 🐉 Сила
 3. **Чи-бонус:** Когда ты переворачиваешь карточку, ты можешь использовать 1 Чи-кристалл и получить возможность добавить Чи-бонус к любой соответствующей боевой способности.



1. **Plemię** 2. **Moce bitewne:** 🐾 Instykt 🐾 Szybkość 🐾 Odwaga 🐾 Siła
3. **Bonus CHI:** Gdy odkryjesz kartę, możesz zapłacić 1 kryształ CHI, aby dodać bonus CHI do dowolnej połączonej błyskawicy mocy bitewnej.



1. **Kmen** 2. **Bojové schopnosti:** 🐾 Instykt 🐾 Rychlost 🐾 Odvaha 🐾 Siła
3. **CHI bonus:** Když otočíš kartu, můžeš zaplatit 1 CHI krystal, a tím navýšit jednu z bojových schopností označených bleskem o CHI bonus.



1. **Kmeň** 2. **Bojové schopnosti:** 🐾 Inštinkt 🐾 Rýchlosť 🐾 Odvaha 🐾 Siła
3. **CHI bonus:** Keď otočíš kartu, môžeš zaplatiť 1 CHI kryštál, a tým pridať CHI bonus na všetky bojové sily zvýraznené s bleskom.



1. **Törzs** 2. **Harcokészségek:** 🐾 Megérzés 🐾 Gyorsaság 🐾 Bátorság 🐾 Erő
3. **CHI bónusz:** Ha felültesz egy kártyát, bármelyik csatolt harcokészséghez vásárolhatsz 1 CHI kristályal CHI bónusz.



1. **Клан** 2. **Бойові сили:** 🐾 Інстинкт 🐾 Швидкість 🐾 Хоробрість 🐾 Міць
3. **CHI-бонус:** Коли ти перевертаєш картку, тобі може випасти 1 CHI кристал ти можеш віддати 1 CHI кристал ти матимеш змогу додати CHI бонус до будь-якої відповідної бойової сили.



1. **Pleme** 2. **Borbene moći:** 🐾 Instykt 🐾 Brzina 🐾 Hrabrost 🐾 Snaga
3. **CHI nagrada:** Kada okreneš kartu, možeš platiti 1 CHI kristal kako bi dodao CHI nagradu bilo kojoj borbenoj moći.



1. **Племе** 2. **Борбене моћи:** 🐾 Инстинкт 🐾 Брзина 🐾 Храброст 🐾 Снага
3. **Чи бонус:** Када обрнеш картицу, мораш платити 1 чи кристал да би додао чи бонус својој борбеној моћи.



1. **Pleme** 2. **Војне моћи:** 🐾 Nagon 🐾 Hitrost 🐾 Pogum 🐾 Moč
3. **CHI Bonus:** Ko obrneš karto, lahko plačaš 1 CHI kristal, da bi kateri koli povezani bojni moči dodal CHI bonus.



1. **Trib** 2. **Puteri de luptă:** 🐾 Instinct 🐾 Viteză 🐾 Curaj 🐾 Putere
3. **Bonus CHI:** Când întorci o carte, poți plăti 1 cristal CHI pentru a adăuga bonusul CHI la oricare putere de luptă asociată.



1. **Племе** 2. **Бойни сили:** 🐾 Инстинкт 🐾 Скорост 🐾 Кураж 🐾 Сила
3. **CHI бонус:** Кога то обврнете карта, можете да платите 1 кристал CHI, за да добавите бонуса CHI към която и да е свързана бойна сила.



1. **Cilts** 2. **Cīņas spēki:** 🐾 Instinkts 🐾 Ātrums 🐾 Drosmē 🐾 Izturība
3. **Či bonus.** Paceļot karti, vari samaksāt vienu 1 Či kristālu, lai pievienotu Či bonusu jebkuram saistītajam cīņas spēkam.



1. **Hõim** 2. **Lahinguvõimed:** 🐾 Instykt 🐾 Kiirus 🐾 Vaprus 🐾 Tugevus
3. **CHI boonuse:** Kaarti ümber pöörates võid mis tahes lahinguvõimele CHI boonuse lisamiseks maksta ühe CHI kristalli.



1. **Genitís** 2. **Kovos galios:** 🐾 Instinktás 🐾 Greitis 🐾 Drasa 🐾 Jėga
3. **Či premija:** Apvertęs kortelę gali sumokėti 1 Či kristalą, kad pridėtum Či premiją prie bet kurios kovos galios.



1. **Kabile** 2. **Savaş güçleri:** 🐾 İlgüdü 🐾 Hız 🐾 Cesaret 🐾 Güç
3. **CHI bonusu:** Bir kart çevirdiğinde, bağlı herhangi bir savaş gücüne CHI bonusu eklemek için 1 CHI kristali ödeyebilirsiniz.



HOW TO PLAY

1. Compete with your Speedorz.
2. The winner flips a card and chooses a battle power.
3. The other player flips a card. Compare the chosen power on both cards.
4. The player with the highest power wins 2 CHI crystals.
5. The first player to get 6 CHI crystals wins the battle.

CHI power: When you flip a card, you may pay 1 CHI crystal to add the CHI bonus to any connected battle power.



SPIELANLEITUNG

1. Tretet mit euren Speedorz im Wettkampf gegeneinander an.
2. Der Gewinner deckt eine Karte auf und wählt eine Kraft aus.
3. Der andere Spieler deckt eine Karte auf. Vergleicht die gewählten Kräfte der beiden Karten.
4. Der Spieler mit der höheren Kraft gewinnt 2 CHI-Kristalle.
5. Gewonnen hat der Spieler, der als Erster 6 Kristalle gesammelt hat.

CHI-Bonus: Wenn du eine Karte aufdeckst, kannst du einen CHI-Kristall zahlen, um den CHI-Bonus zu erhalten. Dieser Bonus gilt nur für eine mit dem CHI verbundene Kraft.



COMMENT JOUER

1. Relève le défi Speedorz.
2. Le gagnant retourne une carte et choisit un pouvoir pour combattre.
3. L'autre joueur retourne une carte. Tu peux maintenant comparer le pouvoir choisi sur les deux cartes.
4. Le joueur avec le pouvoir le plus élevé gagne deux cristaux CHI.
5. Le premier joueur à obtenir 6 cristaux CHI gagne le combat.

Bonus CHI : Quand tu retournes une carte, tu peux ajouter des points Bonus à tout pouvoir relié au CHI, contre le don d'un cristal CHI.



REGOLE DEL GIOCO

1. Sfidatevi con gli Speedorz.
2. Il vincitore scopre una carta e sceglie un potere.
3. L'altro giocatore scopre una carta. Confrontate il potere scelto su entrambe le carte.
4. Il giocatore con il potere più alto vince 2 cristalli CHI.
5. Il primo giocatore che conquista 6 cristalli CHI vince la battaglia.

Bonus CHI: Quando scopri una carta, puoi pagare 1 cristallo CHI per aggiungere un CHI bonus al potere scelto per la battaglia.



ZO SPEEL JE HET SPEL

1. Hou een wedstrijd met je Speedorz.
2. De winnaar draait een kaart om en kiest een kracht.
3. Dan draait de andere speler een kaart om.
4. Vergelijk de gekozen kracht van de 2 kaarten.
5. De speler die als eerste 6 CHI kristallen verzamelt, wint het gevecht.

CHI bonus: Als je een kaart omdraait, mag je 1 CHI kristal betalen om de CHI bonus toe te voegen aan een daarmee verbonden kracht.



CÓMO SE JUEGA

1. Compíte con tu Speedorz. 2. El ganador da la vuelta a una carta y elige un poder de combate. 3. El otro jugador da la vuelta a una carta. Ambas cartas se comparan en relación con el poder elegido. 4. El jugador que posea más poder gana 2 cristales de CHI. 5. El primer jugador en conseguir 6 cristales de CHI gana el combate.

Bonificación de CHI: Al dar la vuelta a una carta, puedes pagar 1 cristal de CHI para asignar la bonificación de CHI a cualquier poder de combate conectado.



SÅDAN SPILLER DU

1. Konkurrer med jeres Speedorz. 2. Vinderen vender et kort og vælger en kampevne. 3. Den anden spiller vender et kort. Sammenlign den valgte evne på de to kort. 4. Spilleren med det højeste tal vinder to CHI-krystaller. 5. Den første spiller, der får seks CHI-krystaller, vinder kampen.

CHI-bonus: Når du vender et kort, kan du betale én CHI-krystal for at føje CHI-bonussen til en forbundet kampevne.



PELIOHJEET

1. Kilpaile Speedorzisi kanssa. 2. Voittaja kääntää kortin ja valitsee taisteluvoiman. 3. Muut pelaajat kääntävät kortin. Vertaa molempien korttien valittua voimaa. 4. Pelaaja, jonka voima on suurempi, voittaa 2 CHI-kristallia. 5. Taistelun voittaa ensimmäisenä 6 CHI-kristallia kerännyt pelaaja.

CHI-bonus: Kun käännät kortin, sinun on maksettava 1 CHI-kristalli lisätäksesi CHI-bonusen johonkin kytketyistä taisteluvoimista.



SÅ HÄR GÅR DET TILL

1. Tävla med era Speedorz. 2. Vinnaren vänder på ett kort och väljer en stridskraft. 3. Den andra spelaren vänder på ett kort. Jämför den valda stridskraften på båda korten. 4. Spelaren med högst kraft vinner 2 CHI-kristaller. 5. Den första spelare som får 6 CHI-kristaller vinner striden.

CHI-bonus: När du vänder på ett kort kan du betala 1 CHI-kristall för att addera CHI-bonusen till en av de anslutna stridskrafterna.



COMO JOGAR

1. Compete com o teu Speedorz. 2. O vencedor vira uma carta e escolhe um poder de combate. 3. O outro jogador vira uma carta. Compara o poder escolhido em ambas as cartas. 4. O jogador com o poder mais elevado ganha 2 cristais CHI. 5. O primeiro jogador a obter 6 cristais CHI ganha o combate.

Bónus CHI: Quando viras uma carta, podes pagar 1 cristal CHI para acrescentares o bónus CHI a qualquer poder de combate associado.



ΠΩΣ ΠΑΙΖΕΤΑΙ

1. Ξεκινήστε την αναμέτρηση με τα Speedorz σας. 2. Ο νικητής γυρίζει μια κάρτα και διαλέγει πολεμική ικανότητα. 3. Ο άλλος παίκτης γυρίζει μια κάρτα. Συγκρίνετε την ικανότητα που διαλέξατε στις δύο κάρτες. 4. Ο παίκτης με τη μεγαλύτερη ικανότητα κερδίζει 2 κρυστάλλους CHI. 5. Ο πρώτος παίκτης που συγκεντρώνει 6 κρυστάλλους CHI κερδίζει τη μάχη.

Έξτρα Βαθμοί CHI: Όταν γυρίζεις μια κάρτα, μπορείς να δώσεις 1 κρύσταλλο CHI για να προσθέσεις τους έξτρα βαθμούς CHI σε οποιαδήποτε πολεμική ικανότητα συνδέεται με αυτούς.



遊び方

1. スピードーズで勝負する。
2. 勝者はカードを1枚取って裏を向ける。そして、バトルパワーを選ぶ。
3. 相手もカードを1枚取って裏を向ける。お互いのカードの選ばれたバトルパワーを比べる。
4. パワーが高い方が子のクリスタルを2個ゲットできる。
5. 先に子のクリスタルを6個手に入れた方が勝者となる。

子のボーナス: カードを取って裏を向けた時に、子のクリスタルを1個使えば、子のボーナスの絵とつながっているバトルパワーに子のボーナスを追加できる。



玩法

1. 迎接挑战。 2. 赢家翻开一张卡片，选择战斗能量。 3. 另一名玩家也翻开一张卡片。比较两张卡片上的能量。 4. 卡片能量高的玩家可以赢得两个真气水晶。 5. 者优先积累到6个真气水晶的玩家赢得战斗。

奖励真气: 翻开卡片时，你可以消费一个真气水晶，将相应真气添加到任何相连的战斗能量中。



플레이 방법

1. 먼저 스피드 게임 배틀을 진행해 주세요. 2. 이기 쪽이 카드 한 장을 뒤집어 배틀 파워를 선택 합니다. 3. 상대방이 카드 한 장을 뒤집어 각자의 카드에서 선택한 배틀 파워 수치를 비교 합니다. 4. 높은 파워 수치가 나온 쪽이 키 크리스탈 2개를 획득 합니다. 5. 키 크리스탈 6개를 먼저 획득한 쪽이 배틀에서 승리하게 됩니다.

키 보너스 : 카드 한 장을 뒤집을 때에, 키 크리스탈 1 개를 먼저 지불하면, 선택한 배틀 파워에 키 보너스를 추가할 수 있습니다.



ПРАВИЛА ИГРЫ

1. Сразитесь в прохождении препятствий на Чимашиклах. 2. Победитель переворачивает карточку и называет любую боевую способность. 3. Другой игрок должен перевернуть свою карточку. Сравните выбранные победителем способности на ваших карточках. 4. Игрок с самой сильной способностью получает Чи-кристалл. 5. Побеждает игрок, который первым получит 6 Чи-кристаллов.

Чи-бонус: когда ты переворачиваешь карточку, ты можешь использовать 1 Чи-кристалл и получить возможность прибавить баллы к той боевой способности, которая соединена молнией с Чи-бонусом на твоей карточке.



ZASADY GRY

1. Walcz swoimi pojazdami Speedorz. 2. Zwycięzca odkrywa kartę i wybiera moc bitewną. 3. Drugi gracz odkrywa kartę. Porównaj wybraną moc na obu kartach. 4. Gracz z najwyższą mocą zdobywa 2 kryształy CHI. 5. Bitwę wygrywa gracz, który jako pierwszy zdobędzie 6 kryształów CHI.

Bonus CHI: Gdy odkryjesz kartę, możesz zapłacić 1 kryształ CHI, aby dodać bonus CHI do dowolnej połączonej błyskawicą mocy bitewnej.



PRAVIDLA HRY

1. Pusť sa do boje se svým Speedorzem. 2. Vítěz otočí kartu a zvolí si bojovou schopnost. 3. Druhý hráč otočí kartu. Hráči si porovnají vybranou bojovou schopnost na svých kartách. 4. Hráč s vyšší bojovou schopností vyhrává 2 CHI krystaly. 5. Hru vyhrává hráč, který jako první nasbírá 6 CHI krystalů.

CHI bonus: Když otočíš kartu, můžeš zaplatit 1 CHI krystal, a tím navýšit jednu z bojových schopností označených bleskem o CHI bonus.



PRAVIDLÁ HRY

1. Pusť sa do boja so svojím Speedorz. 2. Víťaz otočí kartu a zvolí si bojovú schopnosť. 3. Druhý hráč otočí kartu. Porovnajte zvolenú bojovú schopnosť na oboch kartách. 4. Hráč s vyššou bojovou schopnosťou vyhráva 2 CHI krystály. 5. Hru vyhráva hráč, ktorý ako prvý nazbiera 6 CHI krystalov.

CHI bonus: Keď otočíš kartu, môžeš zaplatiť 1 CHI krýštál, a tým pridať CHI bonus na všetky bojové sily zvýraznené s bleskom.



JÁTÉKSZABÁLY

1. Versenyezz a Speedorzoddal. 2. A nyertes felüt egy kártyát és harckészséget választ. 3. A másik játékos felüt egy kártyát. Hasonlítsd össze mindkét kártyán a kiválasztott harckészség erejét. 4. A legerősebb lap 2 CHI kristályt nyer. 5. Akinek először lesz 6 CHI kristálya, az nyer.

CHI bónusz: Ha felütsz egy kártyát, bármelyik csatolt harckészséghez vásárolhatsz 1 CHI kristállyal CHI bónuszt.



ПРАВИЛА ГРИ

1. Розіграйте завдання. 2. Переможець перевертає картку та обирає бойову силу. 3. Інший гравець перевертає картку. Порівняйте обрані сили на обох картках. 4. Гравець з максимальною силою отримує 2 Чи-кристали. 5. Перемагає гравець, який першим отримує 6 Чи-кристалів.

Чи-бонус: Коли ти перевертаєш картку, тобі може випасти 1 Чи-кристал ти можеш віддати 1 Чи-кристал і матимеш змогу додати Чи-бонус до будь-якої відповідної бойової сили.



KAKO SE IGRA

1. Odigraj izazov. 2. Pobjednik okreće kartu i odabire borbenu moć. 3. Drugi igrač okreće kartu. Usporedite odabrane moći na obje karte. 4. Igrač s najvećom moći osvaja 2 CHI kristala. 5. Prvi igrač koji osvoji 6 CHI kristala pobjeđuje u bitci.

CHI nagrada: Kada okreneš kartu, možeš platiti 1 CHI kristal kako bi dodao CHI nagradu bilo kojoj borbenoj moći.



КАКО ИГРАТИ

1. Одиграјте такмичење. 2. Победник обрне картицу и бира борбену моћ. 3. Други играч обрне картицу. Упоредите изабрану моћ на обе картице. 4. Играч са највећом моћи осваја 2 чи кристала. 5. Први играч који сакупи 6 чи кристала је победник.

Чи бонус: Када обрнеш картицу, мораш платити 1 чи кристал да би додао чи бонус својој борбеној моћи.



КАКО ИГРАТИ

1. Такмиј с својим Speedorzom. 2. Zmagovalec obrne karto in si izbere bojno moč. 3. Drugi igralec obrne karto. Primerajta izbrano bojno moč na kartah. 4. Igralec z večjo močjo dobi 2 CHI kristala. 5. Zmaga prvi igralec, ki dobi 6 CHI kristalov.

CHI bonus: Ko obrneš karto, lahko plačaš 1 CHI kristal, da bi kateri kolli povezani bojni moči dodal CHI bonus.



CUM SE JOACĂ

1. Intră în competiție cu Speedorz-ul tău. 2. Câștigătorul întoarce o carte și alege o putere de luptă. 3. Celălalt jucător întoarce o carte. Comparați puterea aleasă pe cele două cărți. 4. Jucătorul cu cea mai mare putere câștigă 2 cristale CHI. 5. Primul jucător care obține 6 cristale CHI câștigă lupta.

Bonus CHI: Când întorci o carte, poți plăti 1 cristal CHI pentru a adăuga bonusul CHI la oricare putere de luptă asociată.



КАК СЕ ИГРАЕ

1. Състезавайте се със Speedorz. 2. Победителят обръща карта и избира бойна сила. 3. Другият играч обръща карта. Сравнете избраната сила и на двете карти. 4. Играчът с най-висока сила печели 2 кристала CHI. 5. Първият играч, който събере 6 кристала CHI, печели играта.

CHI бонус: Когато обърнете карта, можете да платите 1 кристал CHI, за да добавите бонуса CHI към която и да е свързана бойна сила.



KĀ SPĒLĒT

1. Sacentieties ar saviem Speedorz varoniem. 2. Uzvarētājs paceļ kārti un izvēlas cīņas spēku. 3. Otrs spēlētājs paceļ kārti. Salīdziniet izvēlēto spēku abās kārtīs. 4. Spēlētājs, kura spēks ir lielāks, iegūst 2 čī kristālus. 5. Spēlētājs, kurš pirmais iegūst 6 čī kristālus, ir uzvarējis cīņā.

Čī bonuss. Paceļot kārti, vari samaksāt vienu 1 Čī kristālu, lai pievienotu Čī bonusu jebkuram saistītajam cīņas spēkam.



MÄNGU KÄIK

1. Võistele oma Speedorziga. 2. Võitja pöörab kaardi ümber ja valib lahinguvõime. 3. Teine mängija pöörab kaardi ümber. Võrrelge valitud võimet mõlemal kaardil. 4. Suurema võimega mängija saab kaks CHI kristalli. 5. Lahingu võidab mängija, kes kogub esimesena kuus CHI kristalli.

CHI boonus: Kaarti ümber pöörates võid mis tahes lahinguvõimele CHI boonuse lisamiseks maksta ühe CHI kristalli.



KAIP ŽAISTI

1. Rungtyniauk su savo Speedorz. 2. Laimėjojas apverčia kortelę ir pasirenka kovos galią. 3. Kitas žaidėjas apverčia kortelę. Palygink abiejose kortelėse nurodytas kovos galias. 4. Didesnė kovos galią turintis žaidėjas laimi du CHI kristalus. 5. Kovą laimi pirmasis 6 CHI kristalus surinkęs žaidėjas.

Či premija: Apvertęs kortelę gali sumokėti 1 Či kristalą, kad pridėtum Či premiją prie bet kurios kovos galios.



NASIL OYNANIR

1. Speedorz ile yarışın. 2. Kazanan bir kart açar ve bir savaş gücü seçer. 3. Rakip oyuncu bir kart açar. Her iki kartta seçilen gücü karşılaştırın. 4. En yüksek güce sahip oyuncu 2 CHI kristali kazanır. 5. 6 CHI kristali kazanan ilk oyuncu savaş kazanır.

CHI bonusu: Bir kart açıldığında, bağlı herhangi bir savaş gücüne CHI bonusu eklemek için 1 CHI kristali ödeyebilirsiniz.

LEGO LEGENDS OF CHIMA™

GORZAN



70109 70008

LAVAL



70115
70010 70005

FURTY



70111

CRAGGER



70115 70006
70014 70010

RAWSOM



70114 70006

SKINNET



70107

ERIS



70114
70009 70003

LAGRAVIS



70108 70010

CRUC



70002
70014 70112

WORRIS



70011 70009



LEGENDS OF
CHIMATM

70203

70200

70010

70115

70009

LEGO.COM/CHIMA





70010



70009



70008



70007



70200



70201



70202



70203



70204



70205



70108



70109



70114



70115



50006



COMBINE THE SETS

KOMBINIERE DIE SETS - COMBINE LES CHALLENGES
COMBINA LOS SETS - COMBINAR AS CONJUNTOS
KOMBINER D'A ENSEMBLES

SCAN THE QR CODE

SCANNEN DEN QR CODE - SCANNER LE QR CODE - CAPTURER EL CODIGO QR
PAR SCANNER LE CODE QR - QU'Y A-T-IL DE LA QR AVEC VOUS



LEGENDS OF CHIMA™



70109



70107



70108



70114



70115



club™

Free*! Gratuit!

* Paid subscription in Australia and New Zealand.
Abonnement payant en Australie et Nouvelle-Zélande



© 2013 The LEGO Group



LEGO.com/club



WIN!

Go to www.LEGOsurvey.com/product to fill out a survey for a chance to win a cool LEGO® Product.

No purchase necessary.

Open to all residents where not prohibited.



www.LEGOsurvey.com/product

GEWINNE!

Nimm an der Umfrage auf www.LEGOsurvey.com/product teil und hab die Chance ein cooles LEGO® Produkt zu gewinnen!

Die Teilnahme am Gewinnspiel führt zu keinerlei Kaufverpflichtungen. Teilnahme in allen nicht ausgeschlossenen Ländern möglich.

WIN!

Ga naar www.LEGOsurvey.com/product, vul een enquêteformulier in en maak kans op een cool LEGO® product.

Geen aankoopverplichting. Iedereen mag deelnemen, uitgezonderd ingezetenden van landen waar een enquêteverbod geldt.

GAGNE!

Visite www.LEGOsurvey.com/product pour répondre à un questionnaire et avoir une chance de gagner un produit LEGO® très cool!

Aucune obligation d'achat. Ouvert à tous les résidents des pays autorisés.

当てよう!

www.LEGOsurvey.com/product にアクセスして、アンケートにご記入ください。当選者にはレゴ®製品を差し上げます。

お買い上げの必要はありません。禁止されていない限り、すべての皆様にご利用いただけます。



LEGO.com

6050570

LEGO, the LEGO logo and LEGENDS OF CHIMA are trademarks of the LEGO Group.
©2013 The LEGO Group.