



CREATOR

10241



EXPERT

Maersk Line



Maersk Line is the container shipping division of A.P. Moller – Maersk. Operating more than 600 container ships and 4,100,000 twenty-foot container units, Maersk Line is the world's leading container shipping company.

Visit www.maerskline.com for more information on our services.

Die Maersk Line ist die Abteilung bei A.P. Moller – Maersk, die für den Containertransport zuständig ist. Sie betreibt mehr als 600 Containerschiffe und 4.100.000 „20-Fuß-Container“ und ist somit das weltgrößte Container-Transportunternehmen.

Weitere Informationen stehen unter www.maerskline.com zur Verfügung.

Maersk Line est la division de transport de conteneurs d'A.P. Moller – Maersk. Avec plus de 600 porte-conteneurs et 4 100 000 conteneurs de 20 pieds (6 mètres), Maersk Line est le plus grand armateur de porte-conteneurs du monde.

Visitez www.maerskline.com pour obtenir plus d'informations sur nos services.

Maersk Line es la división de transporte de contenedores de A.P. Moller – Maersk. Con más de 600 buques de contenedores y 4.100.000 contenedores de veinte pies, Maersk Line es la empresa de transporte de contenedores más importante del mundo.

Visita el sitio web www.maerskline.com si deseas obtener más información acerca de nuestros servicios.

Maersk Line é a divisão de transporte marítimo da A.P. Moller – Maersk. Moller – Maersk. A operar mais de 600 navios de transporte de contentores e 4.100,000 TEU (contentores de vinte pés), a Maersk Line é a maior empresa a nível mundial de transporte de contentores.

Visite www.maerskline.com para mais informações sobre os nossos serviços.

A Maersk Line az A.P. Moller – Maersk konténerszállító részlege. Több mint 600 konténerszállító hajót és 4 100 000 húszlábás konténert üzemeltetve, a Maersk Line a világ vezető konténerszállító vállalata.

Szolgáltatásainkról bővebben tájékozódhat a www.maerskline.com honlapon.

The Container – Le Conteneur

The container is a vital tool in today's global world. In containers, raw materials and manufactured goods can be transported around the world, at sea, by truck and on rail wagons.

The typical container is either a 20 foot container or a 40 foot container. It can be a dry container or a refrigerated container or a special container, like a flat-rack container.

The container and low-cost, reliable shipping in combination with efficient container terminals and the vast infrastructures of motorways and railroads make up the most important transport system in the world. Maersk Line provides its customers with the world's most reliable services.

Der Container ist aus der heutigen globalisierten Welt nicht mehr wegzudenken. Mithilfe von Containern können Rohstoffe und hergestellte Waren weltweit über den Seeweg, die Straße oder per Bahn transportiert werden.

Der typische Container ist entweder ein so genannter „20-Fuß-Container“ mit ca. 6 Metern Länge oder ein „40-Fuß-Container“ mit etwas über 12 Metern Länge. Neben Trockencontainern und Kühlcontainern gibt es auch spezielle Container wie zum Beispiel den Flachcontainer.

Der Container und der kostengünstige Transport bilden in Verbindung mit leistungsstarken Container-Terminals und einer riesigen Infrastruktur aus Bahn- und Straßennetz eines der wichtigsten Transportsysteme der Welt. Die Maersk Line bietet ihren Kunden einen der weltweit zuverlässigsten Dienste.

Le conteneur est un outil vital dans le monde globalisé d'aujourd'hui. Grâce aux conteneurs, les matières premières et les produits finis peuvent être transportés dans le monde entier par bateau, par camion et sur des wagons de train.

Le conteneur typique mesure soit 20 pieds (6 mètres), soit 40 pieds (12 mètres). Il peut être sec, réfrigéré ou spécial, par exemple un conteneur plateforme.

Les conteneurs et un transport maritime fiable à faible coût, combinés avec des terminaux pour conteneurs efficaces et de vastes infrastructures d'autoroutes et de voies ferrées composent le système de transport le plus important au monde. Maersk Line fournit à ses clients les services les plus fiables au monde.

El contenedor es una herramienta fundamental para el mundo globalizado actual. Los contenedores permiten transportar materias primas y artículos manufacturados a todas partes del mundo, en barco, en camión y en ferrocarril.

Un contenedor típico mide 20 o 40 pies. Puede ser un contenedor seco, refrigerado o especial, como los de plataforma.

Al representar un medio de transporte barato y seguro, y contar con eficaces terminales de contenedores y vastas redes de carretera y ferrocarril, el contenedor es el sistema de transporte más importante del mundo. Maersk Line presta a sus clientes los servicios más seguros del mundo.

O contentor é uma ferramenta vital no mundo globalizado de hoje. Graças aos contentores, matérias primas e bens manufaturados podem ser transportados para toda a parte do mundo, por mar, caminhão e por caminhos de ferro.

Entende-se por **contentor normal**, um contentor com 20 pés ou 40 pés. Pode ser um contentor seco, refrigerado ou especial, tal como um contentor de caixa aberta.

O contentor e o transporte de confiança barato, combinados com os terminais eficientes para contentores e a vasta infraestrutura de autoestradas e caminhos de ferro tornam-no o mais importante sistema de transporte do mundo. A Maersk Line oferece aos seus clientes os serviços de maior confiança a nível mundial.

A konténer létfontosságú szerepet tölt be napjaink globalizált világában. Konténerekben lehet szállítani világszerte a nyersanyagokat, a készárakat tengeren, kamionokon és vasúti kocsikon.

A tipikus konténer lehet 20 lábás vagy 40 lábás konténer. Ez lehet száraz konténer vagy hűtött konténer, esetleg speciális konténer, mint például a nyitott konténer.

A konténer és az alacsony költségű, megbízható szállítás a hatékony konténer terminálokkal és az autóutak és vasutak óriási infrastruktúrájával a világ legfontosabb szállítási rendszerét alkotja. A Maersk Line a világ legmegbízhatóbb szolgáltatásai nyújtja felhasználóinak.



CHALLENGE:
Build a LEGO® model interpretation of
the world's largest ship

HERAUSFORDERUNG:
Ein LEGO® Modell bauen, das vom
größten Schiff der Welt inspiriert ist

DÉFI :
Construis un modèle LEGO® du plus
grand bateau du monde

ACEPTA EL DESAFÍO:
Construye el barco más grande del
mundo al estilo LEGO®

DESAFIO:
Constrói o modelo LEGO® que é a
interpretação do maior barco do mundo

KIHÍVÁS:
Építsd meg a világ legnagyobb
hajójának LEGO® modelljét



Designer building the model
Der Designer bei der Arbeit
Designer construisant le modèle
El diseñador construye el modelo
Designer a construir o modelo
Tervező a modell építése közben



Authenticity down to placing a good-luck coin under the mast

Authentizität bis ins letzte Detail: die Münze am Mast

L'authenticité va jusqu'à placer une pièce porte-bonheur sous le mât

Máximo realismo: coloca una moneda de la buena suerte bajo el mástil

Autêntico ao ponto de ter uma moeda de boa sorte sob o mastro

Hitelesség, egészen az árboc alatti szerencse érme elhelyezéséig.

Approval by the license partner
A.P. Moller-Maersk

Freigabe durch den Lizenzpartner
A.P. Moller-Maersk

Approbation par le partenaire de licence,
A.P. Moller-Maersk

Aprobado por el propietario de la licencia:
A.P. Moller-Maersk

Aprovação pelo parceiro detentor da
licença, a A.P. Moller-Maersk

Jóváhagyás licencpartnerünk, az
A.P. Moller-Maersk által.



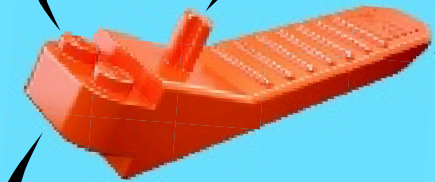
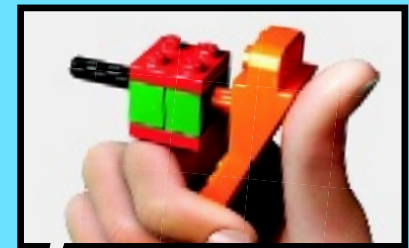

LEGO.com/
brickseparator

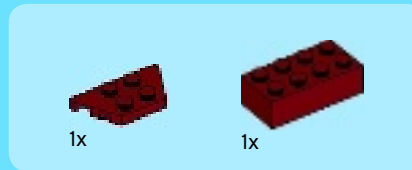

1

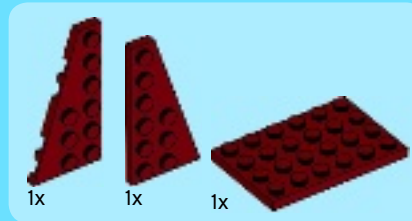
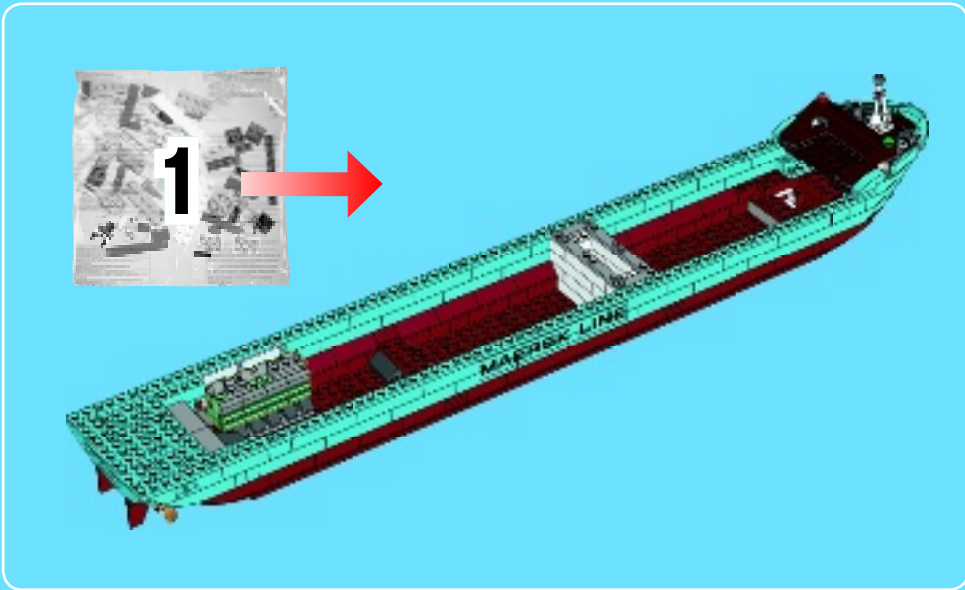

2

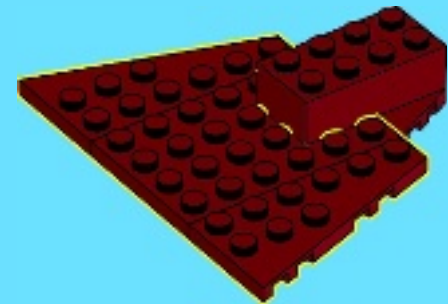



2x



2x

3

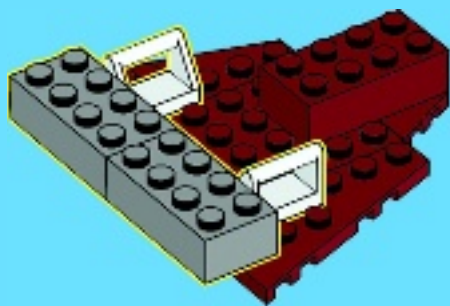

1x

4

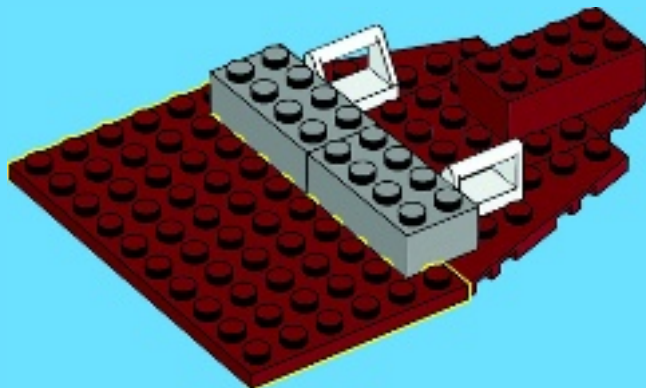

6x

5

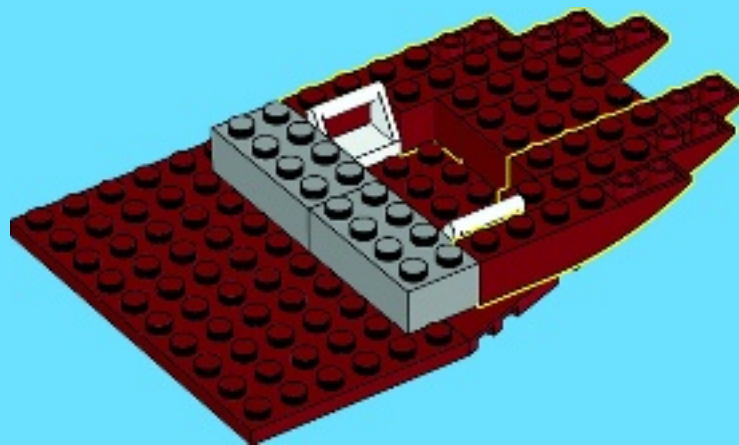

6x



1x



1x

6

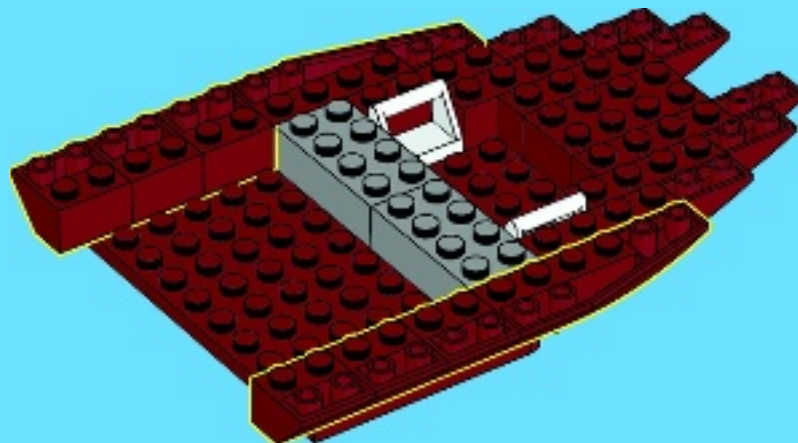

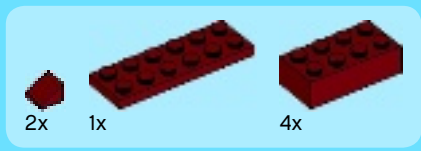

7

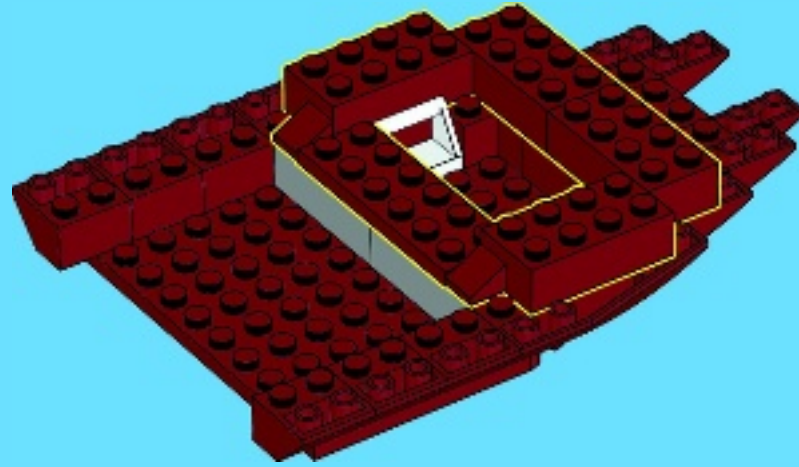

8

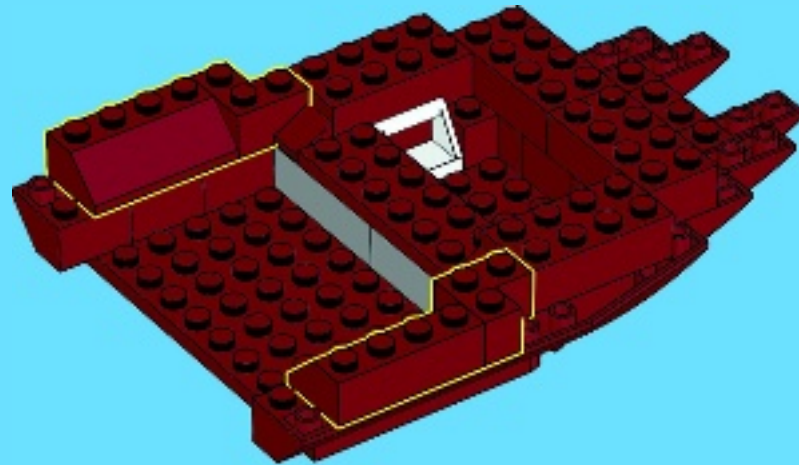

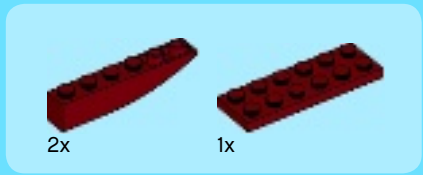

9

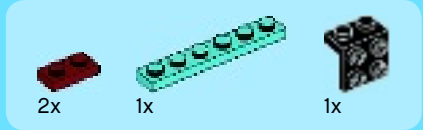
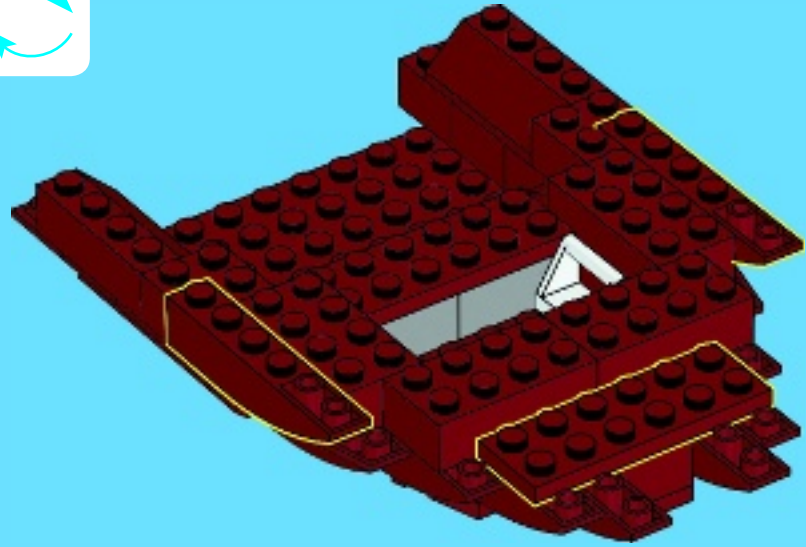

10

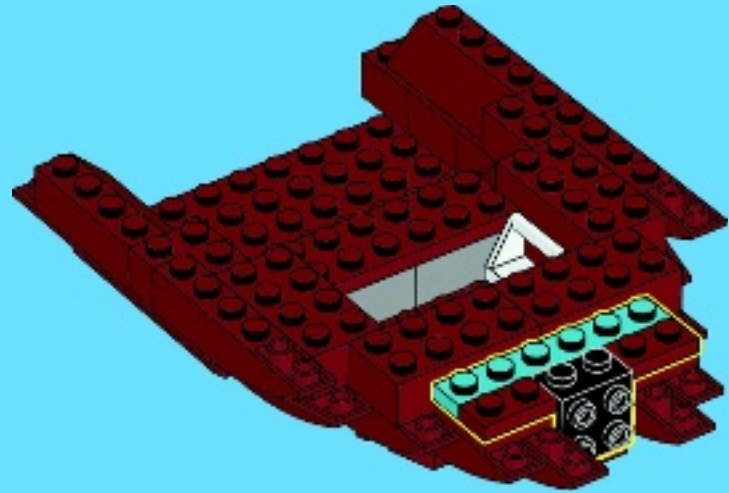

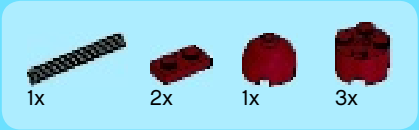

11

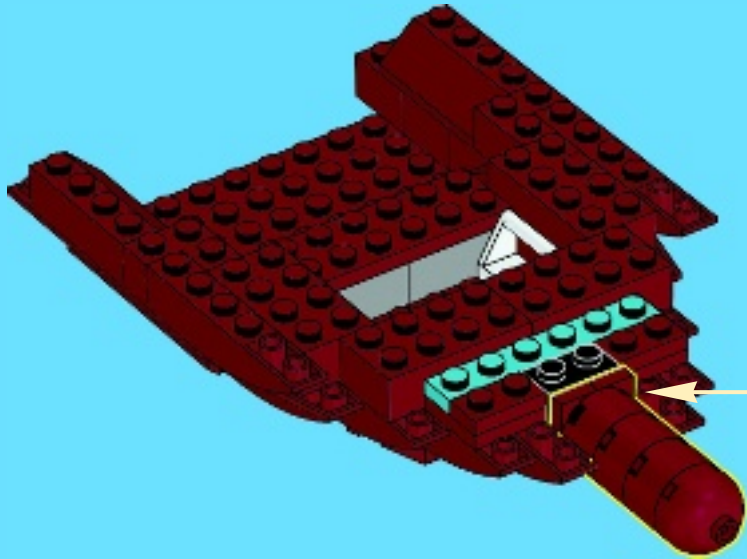
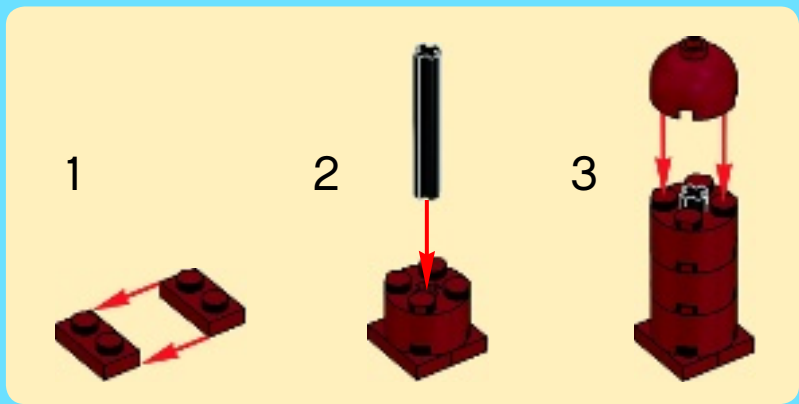

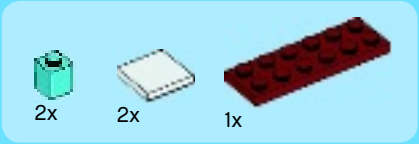

12

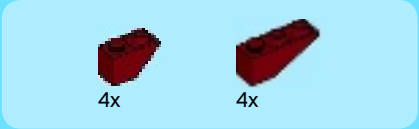
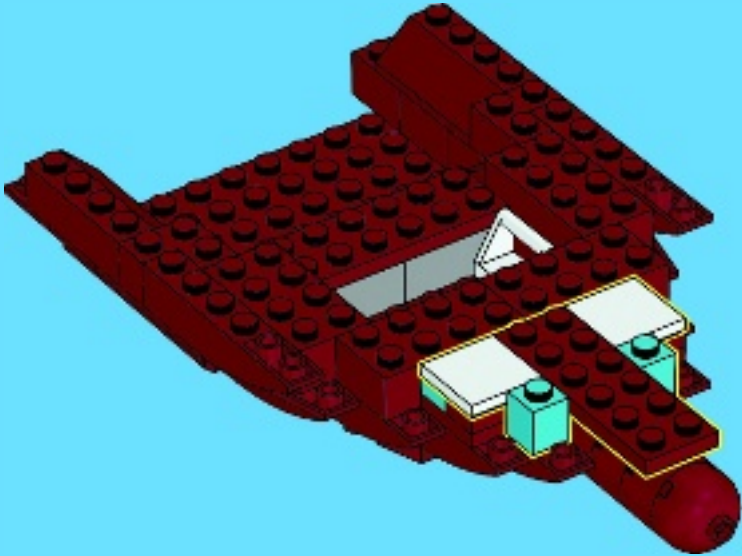

13

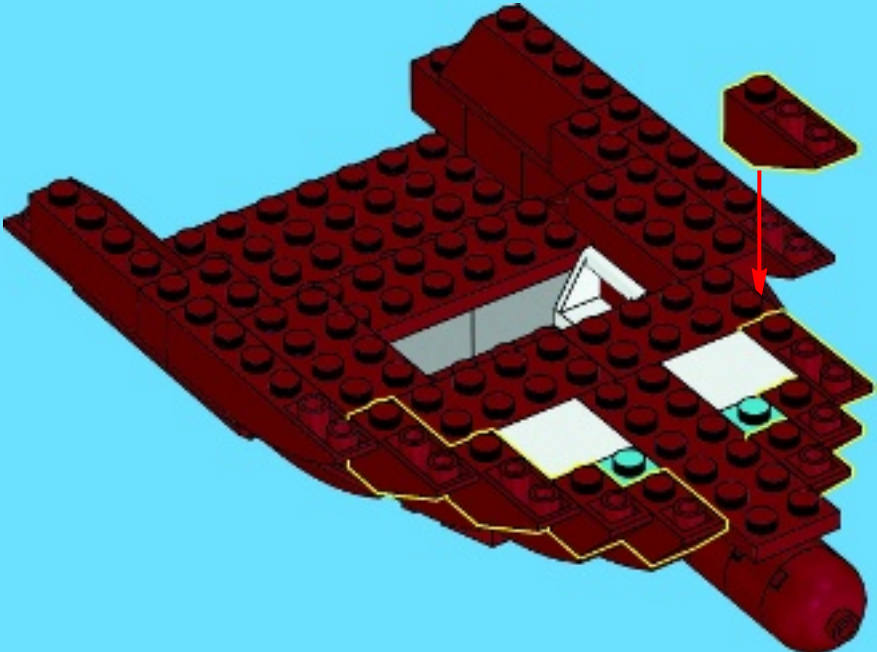



14

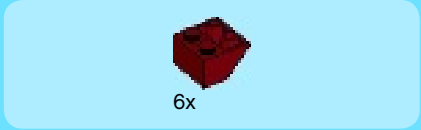
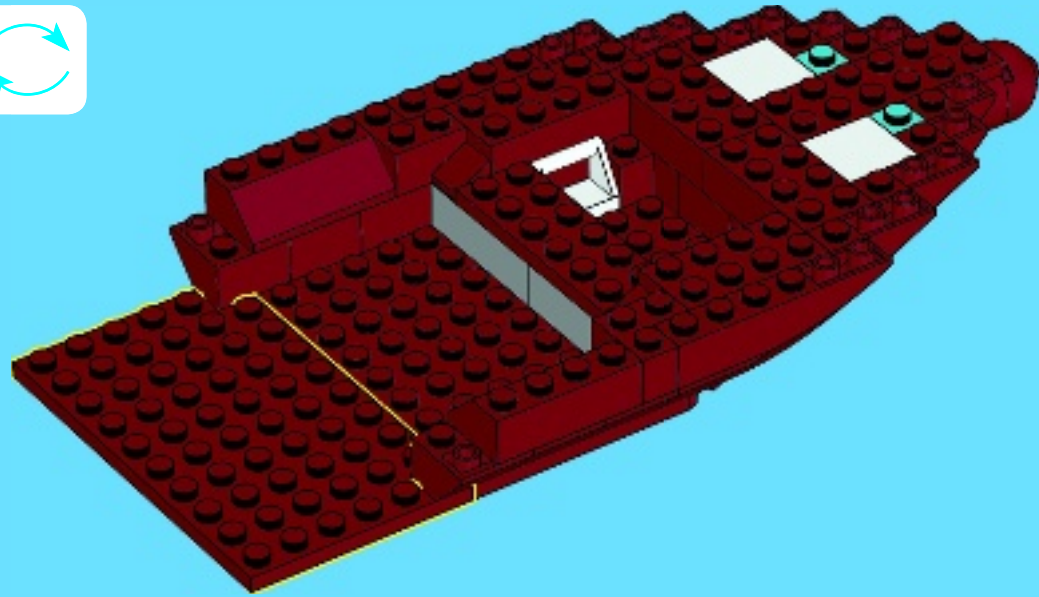

15

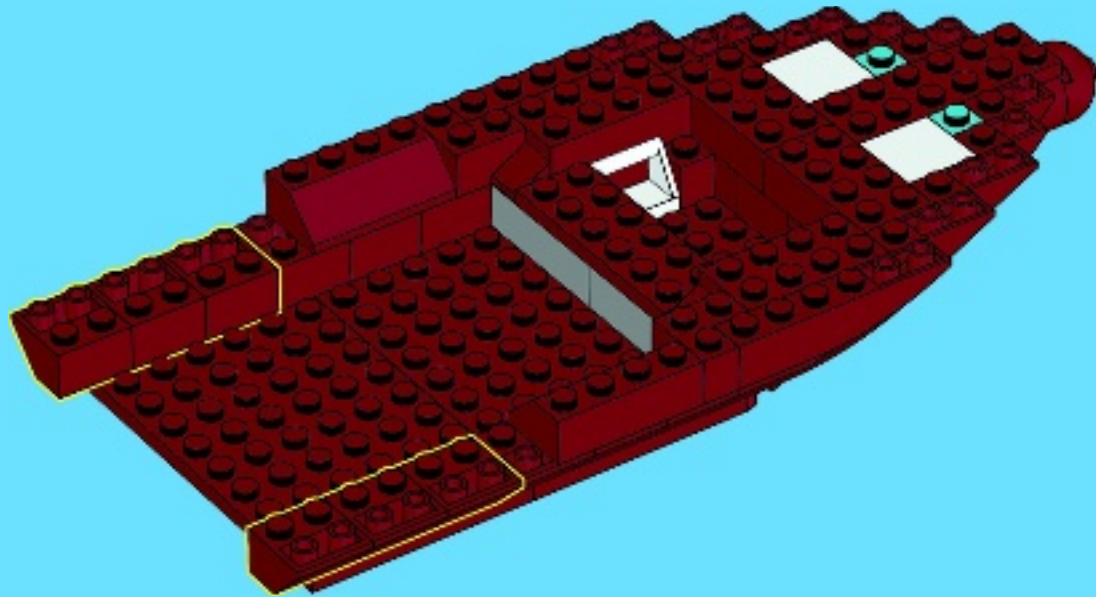

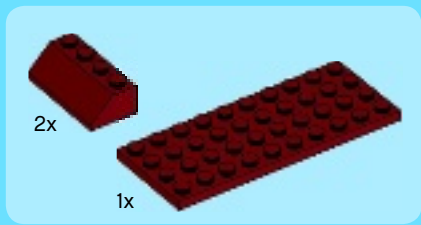

16

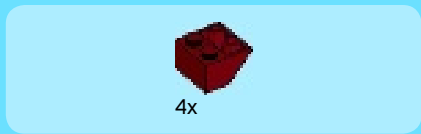
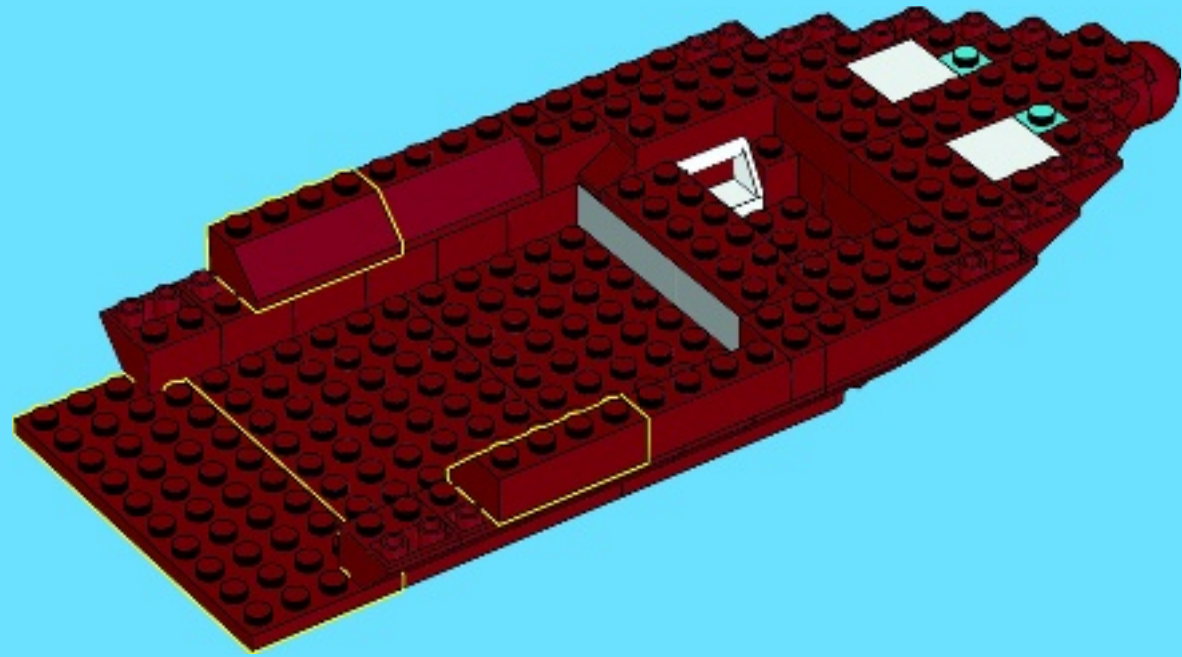

17

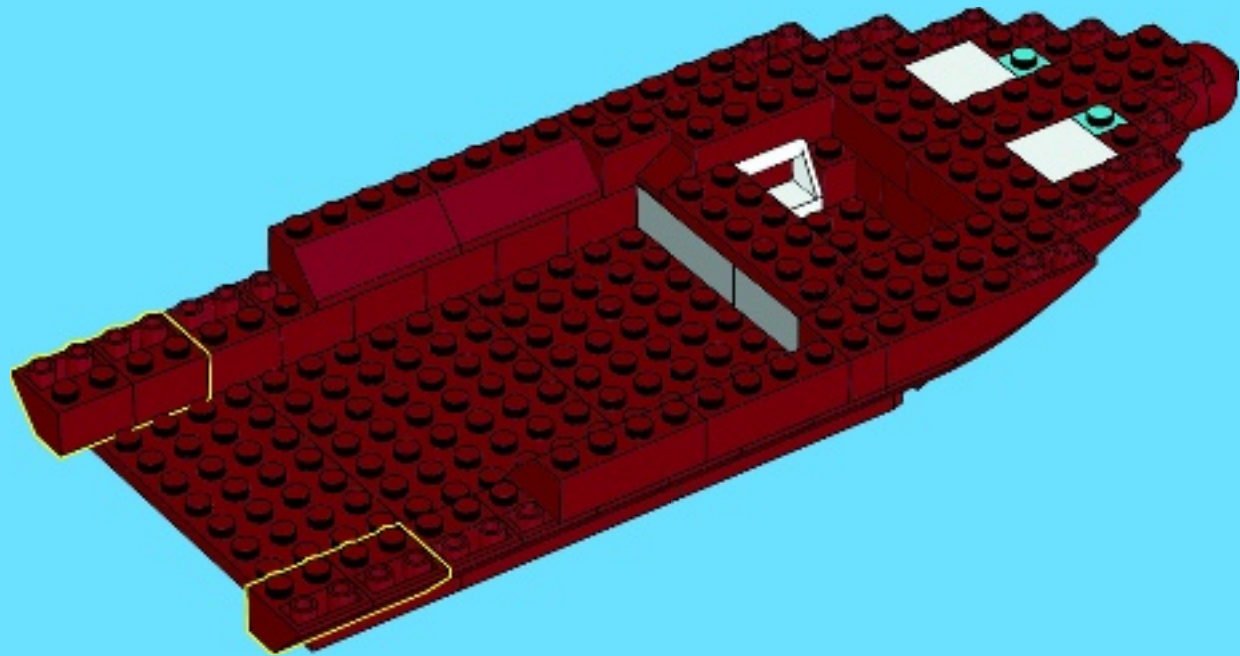



18

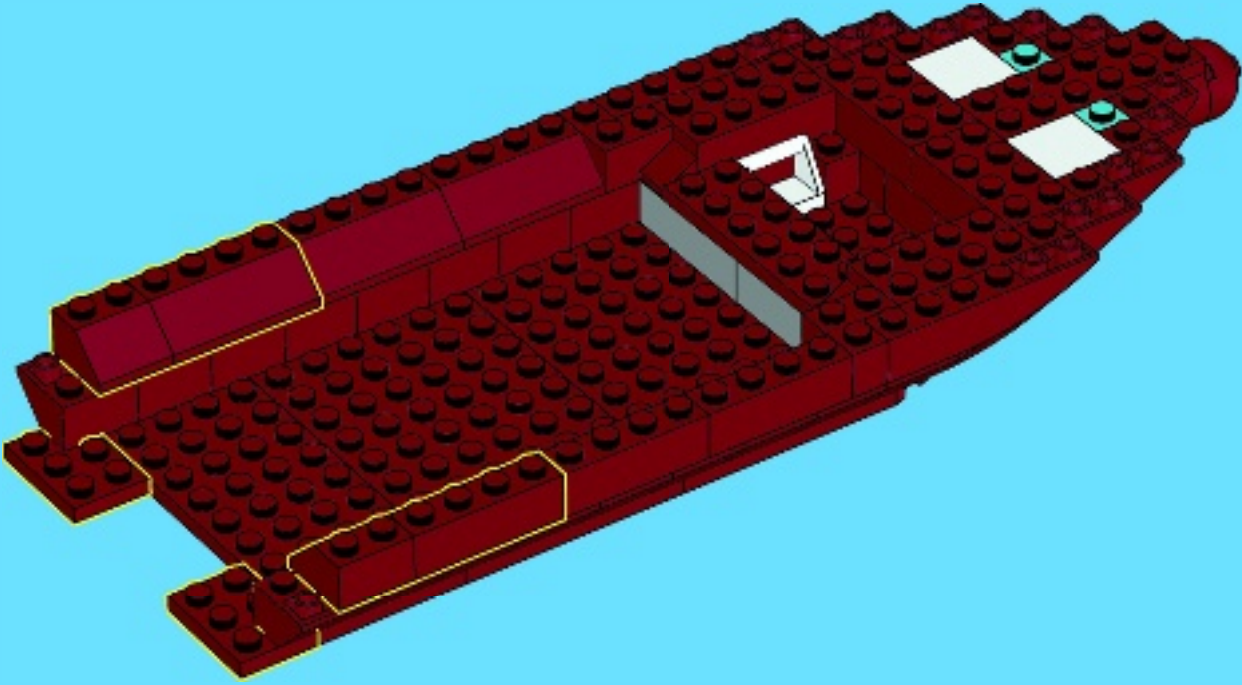

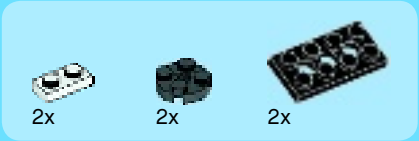

19

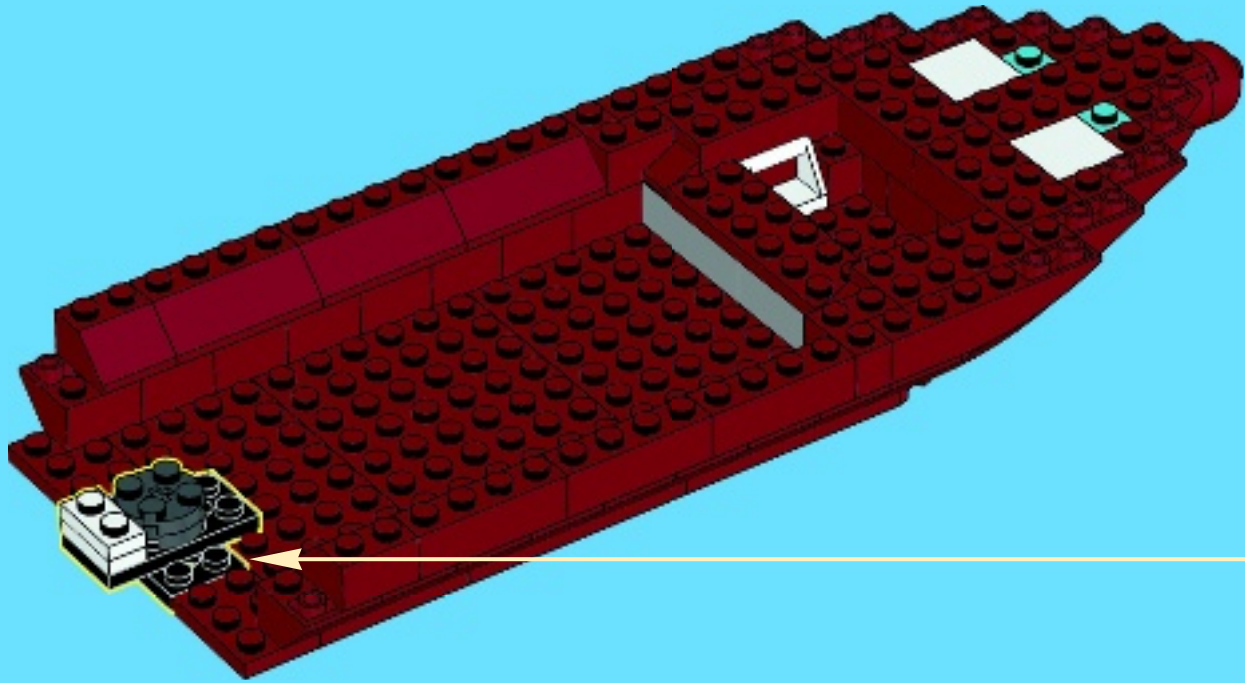



2x



2x

20

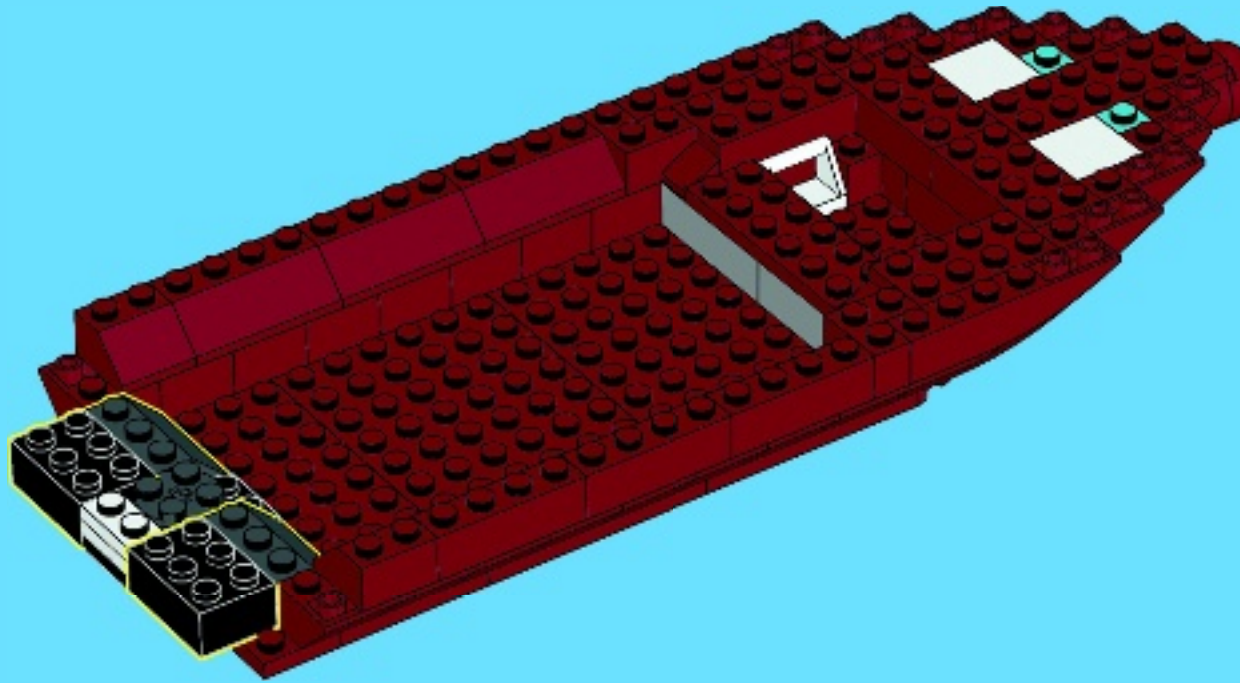



21

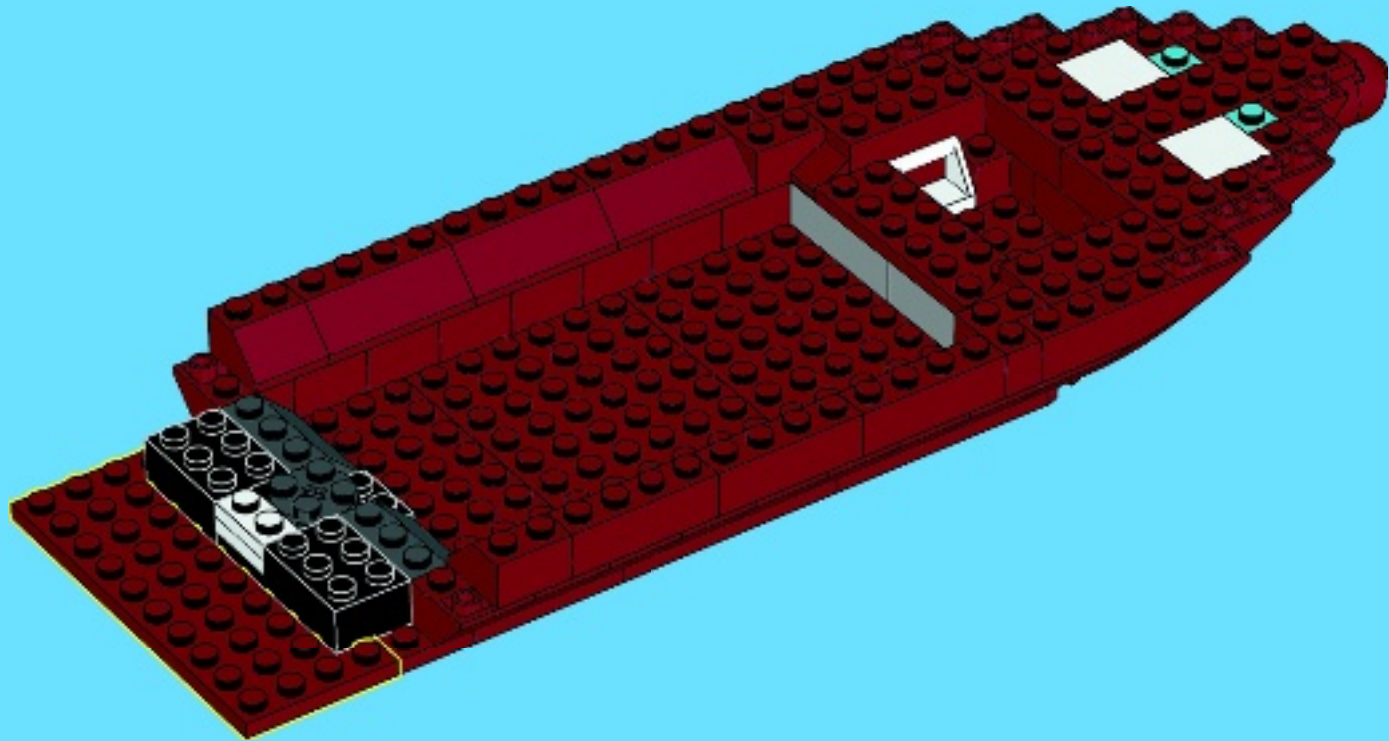



6x

22

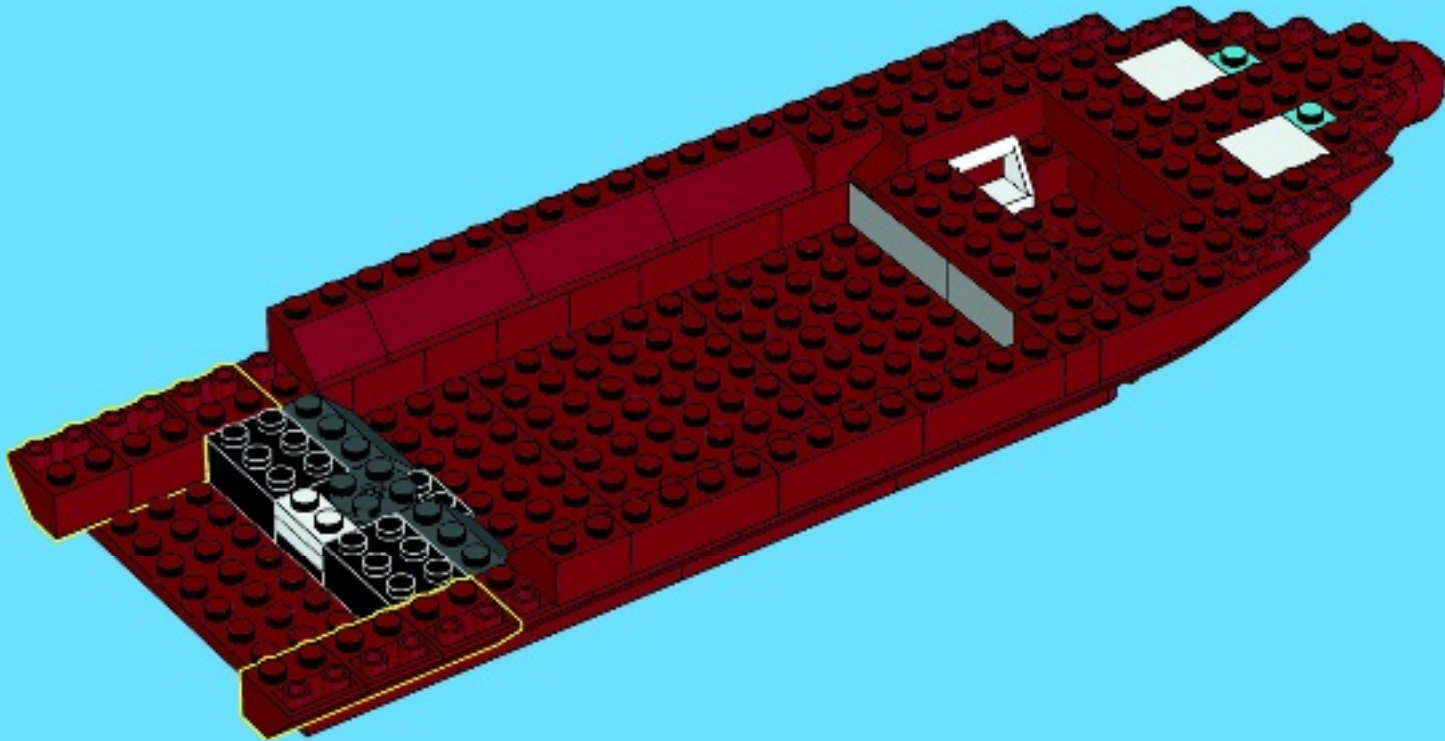

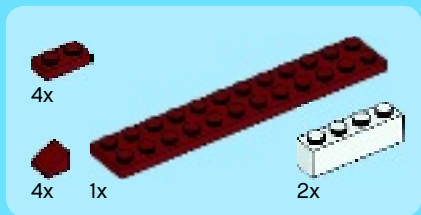

23

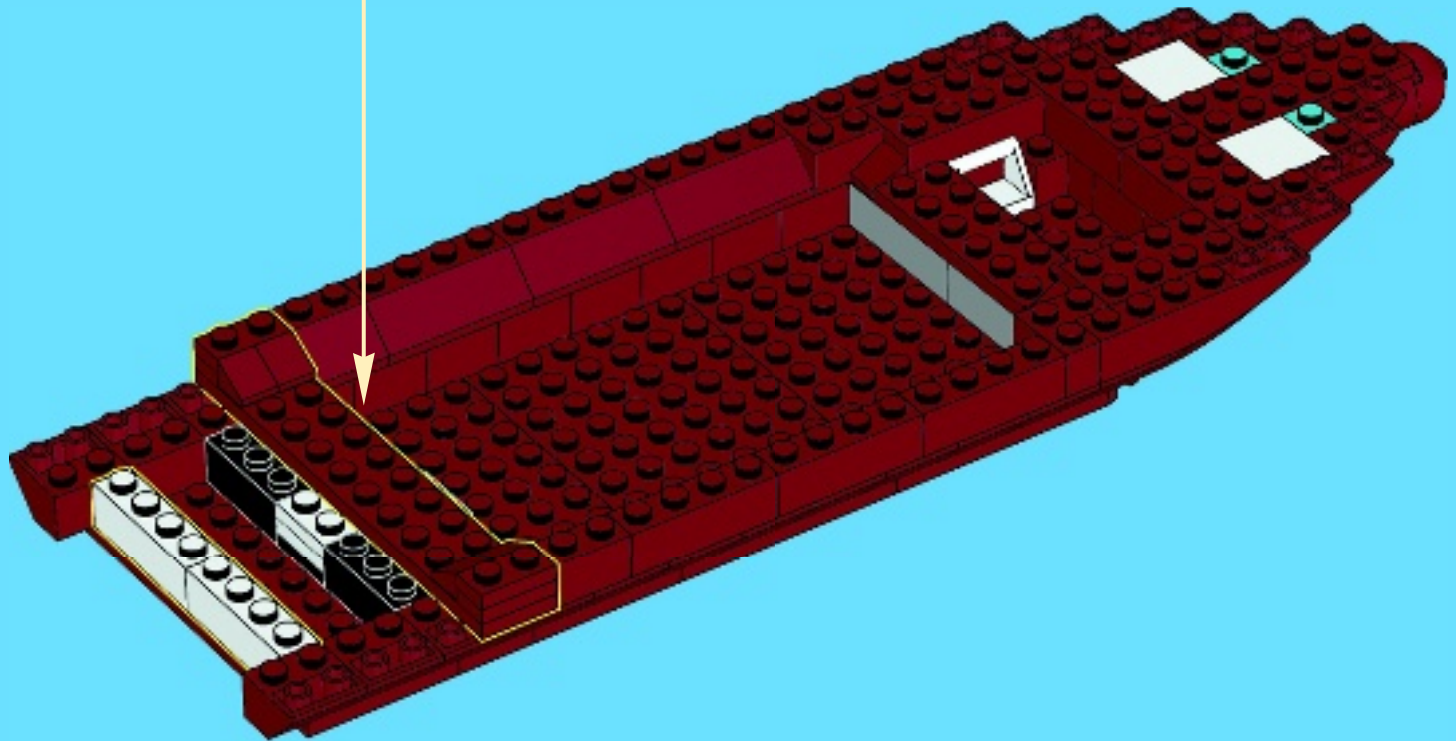
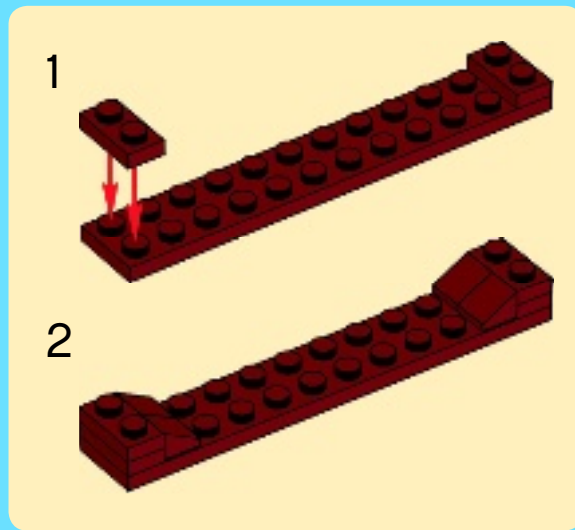



24

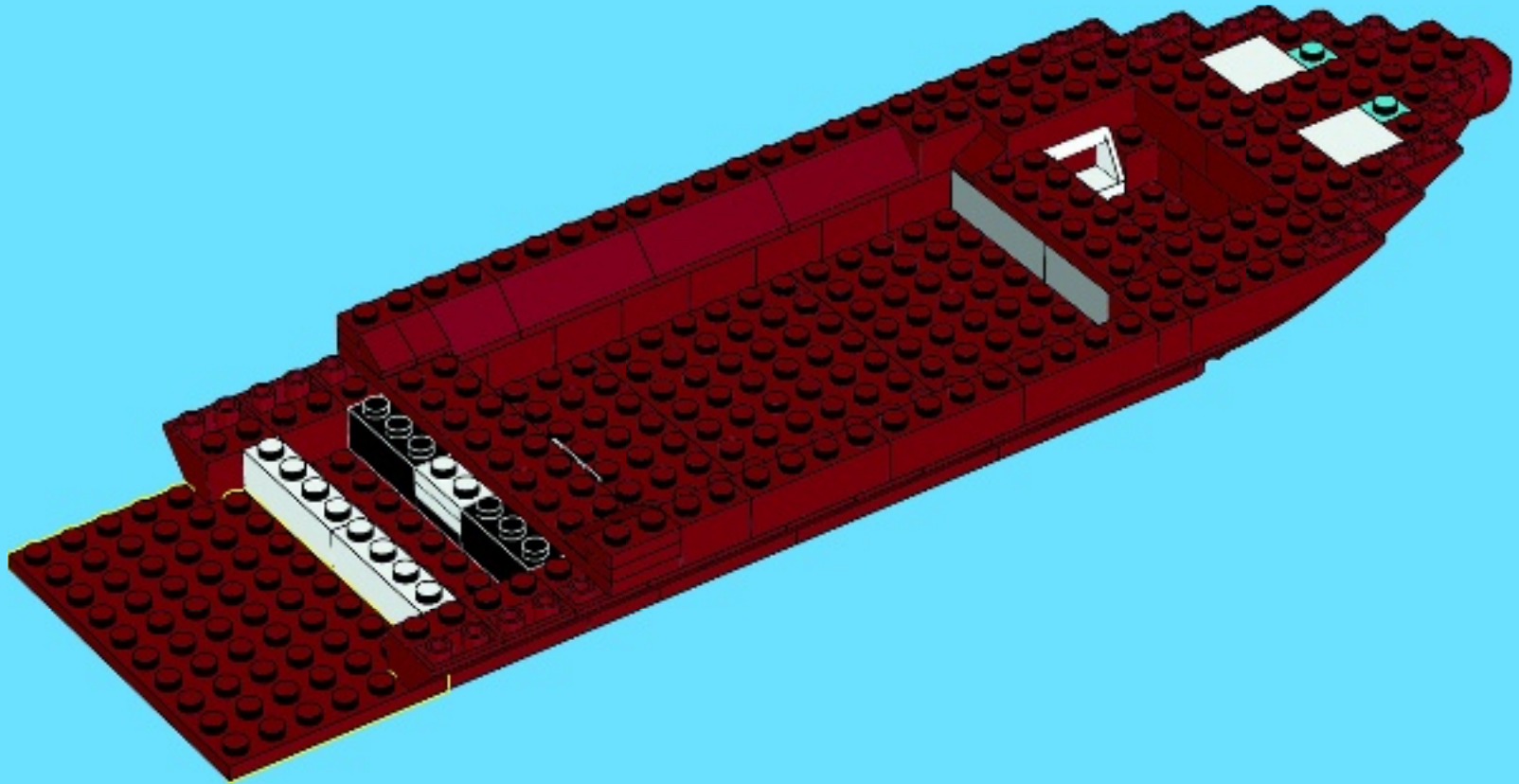

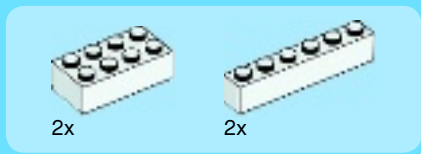

25

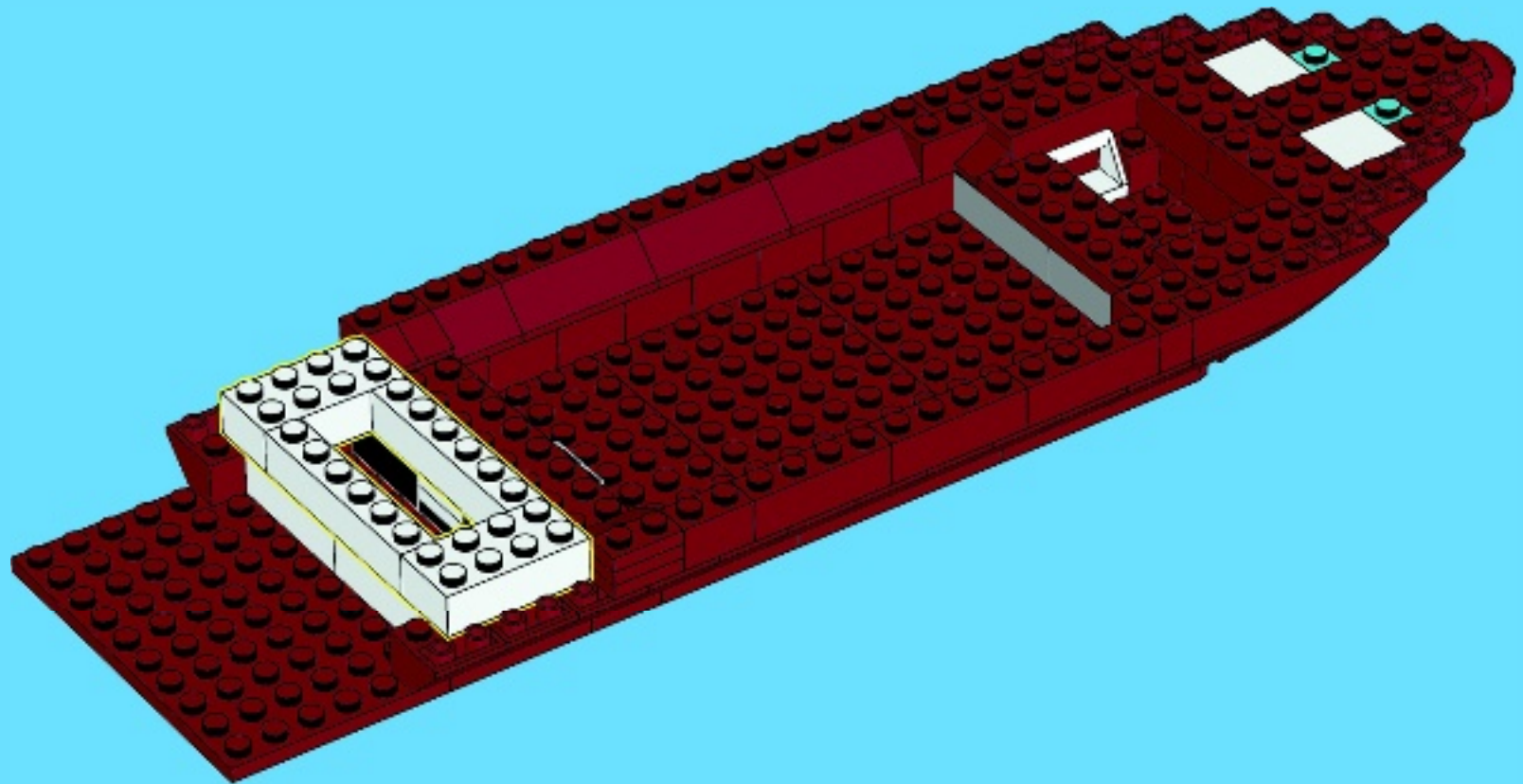



2x



6x

26

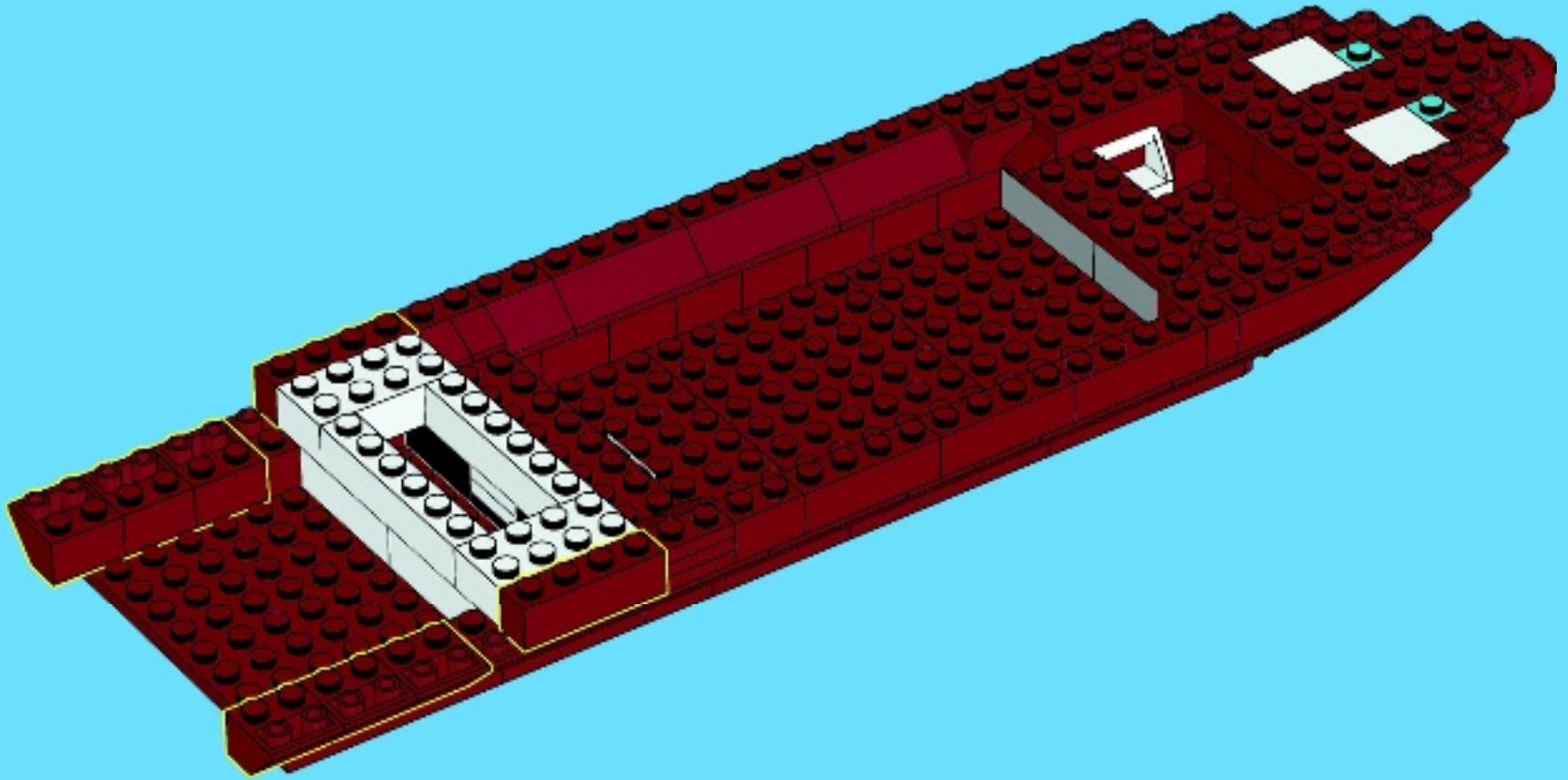



27

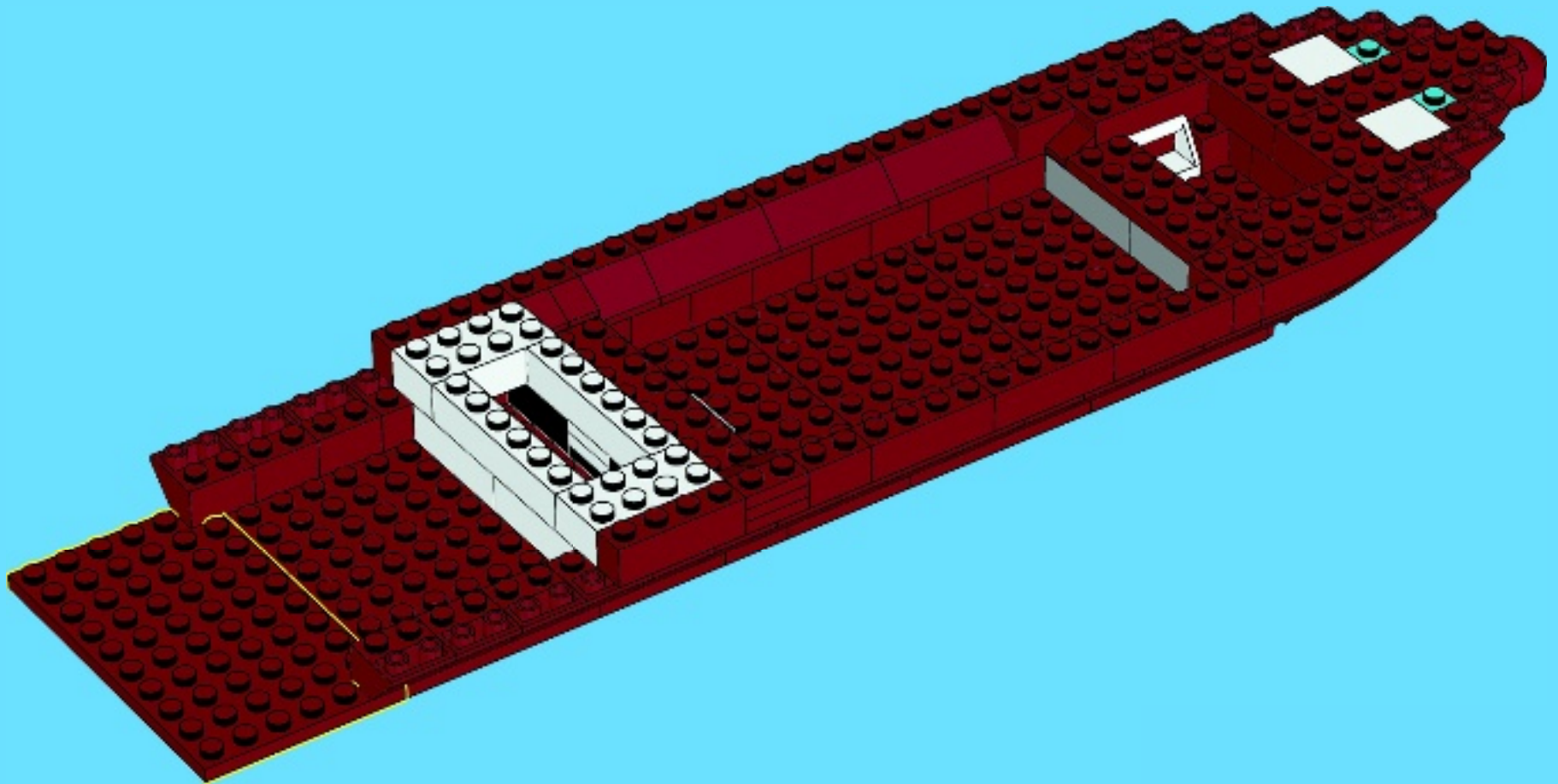



6x

28

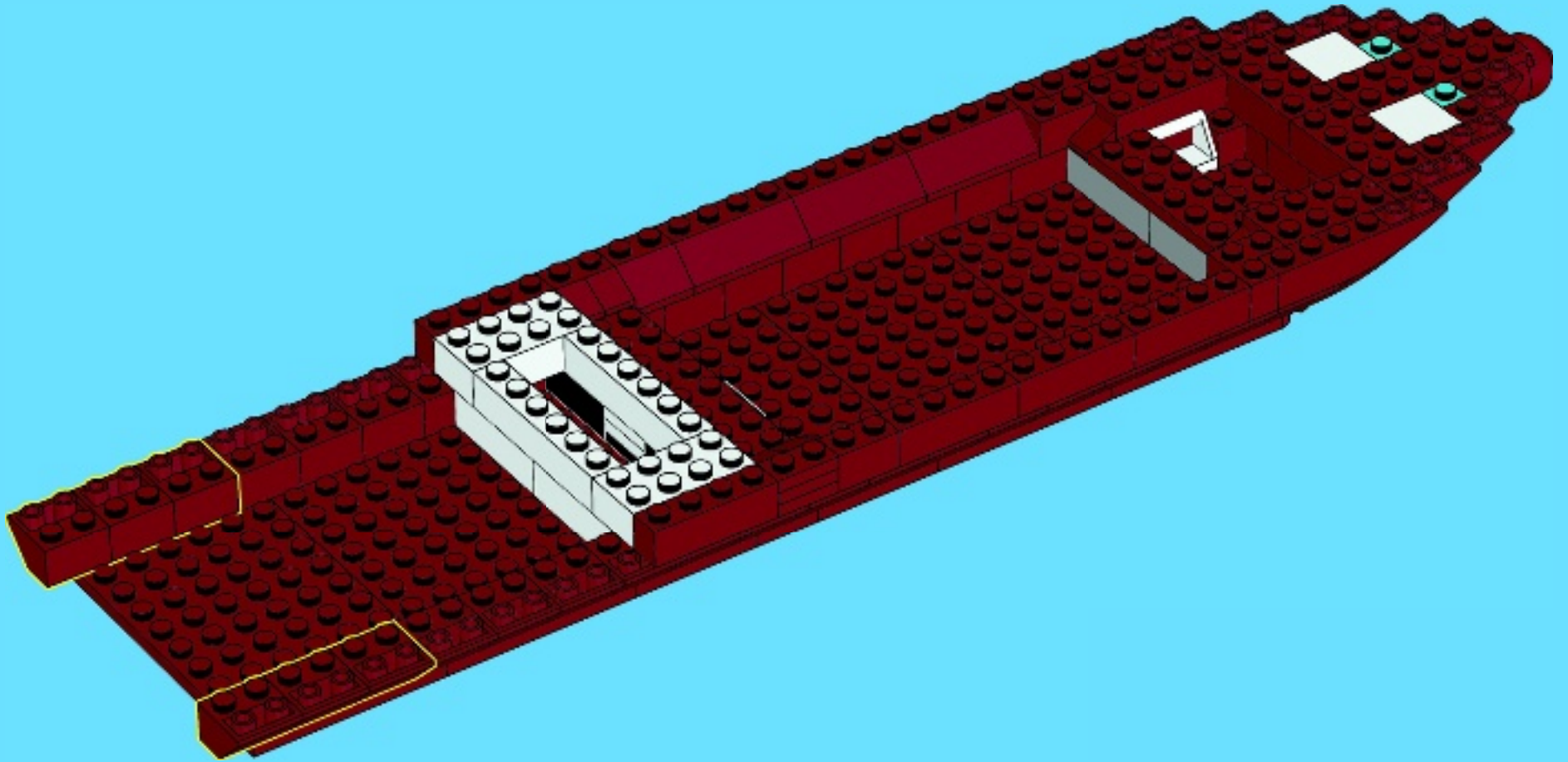

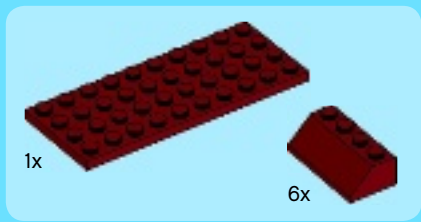

29

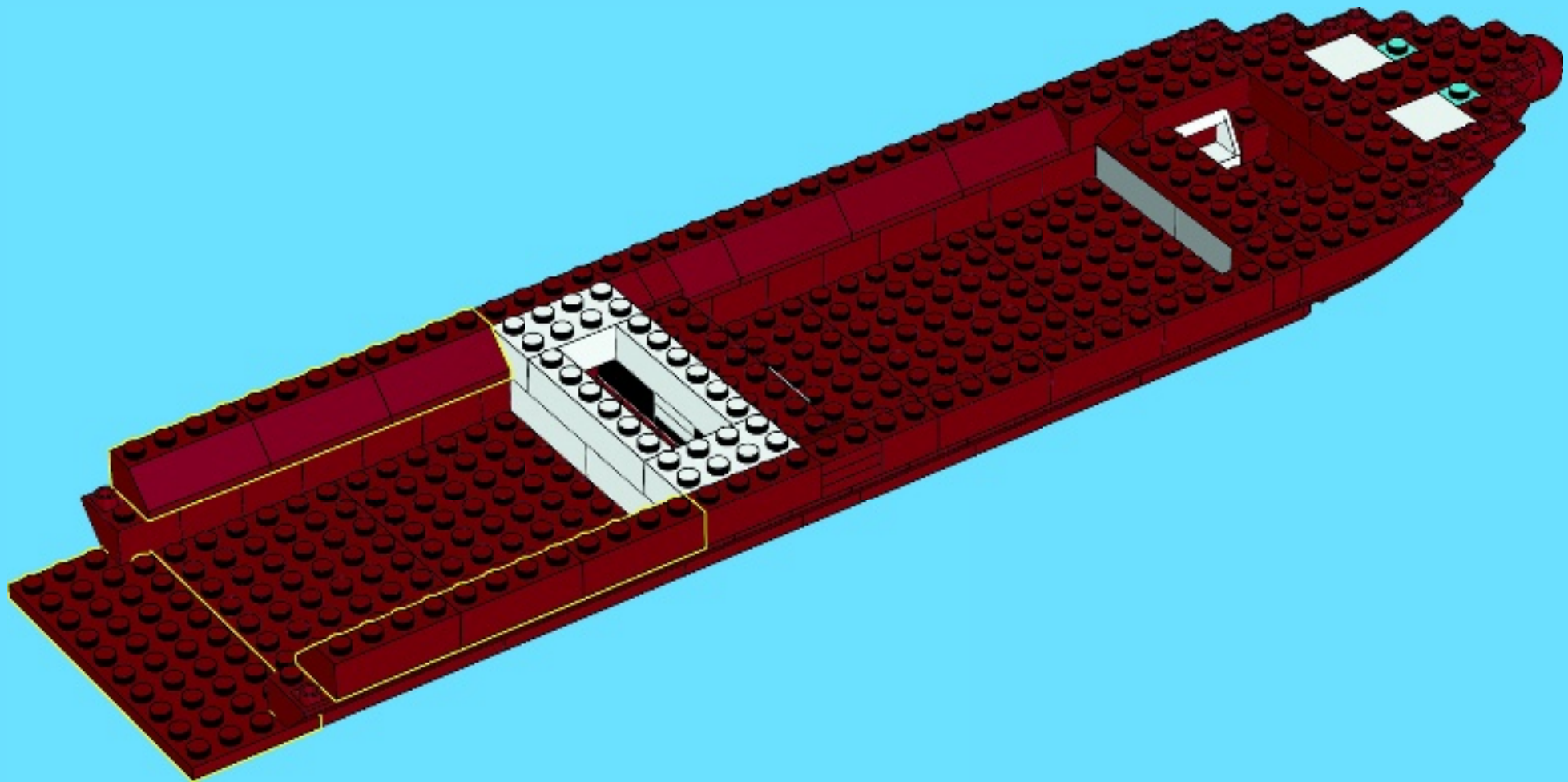



4x

30

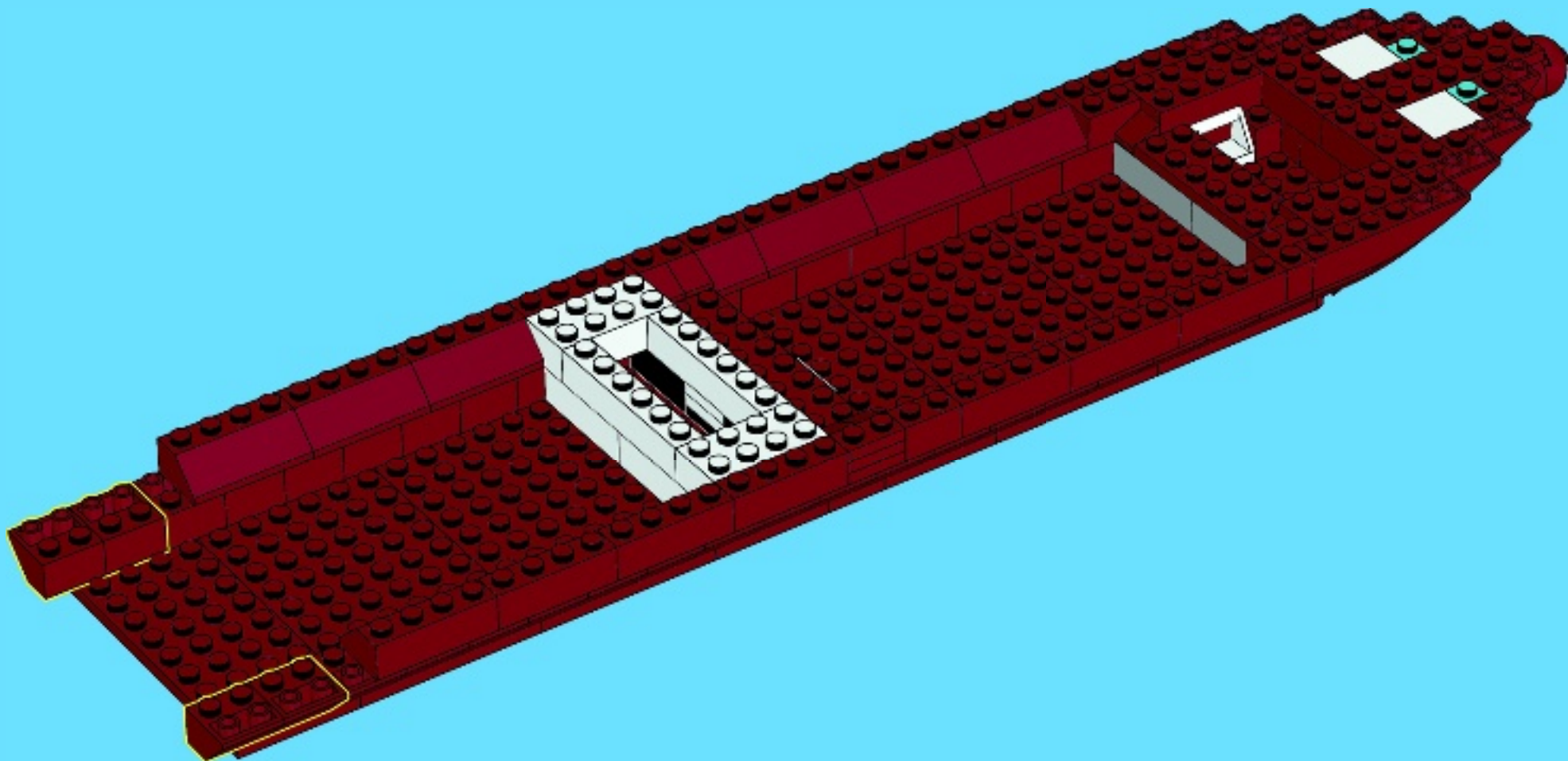



2x



2x

31

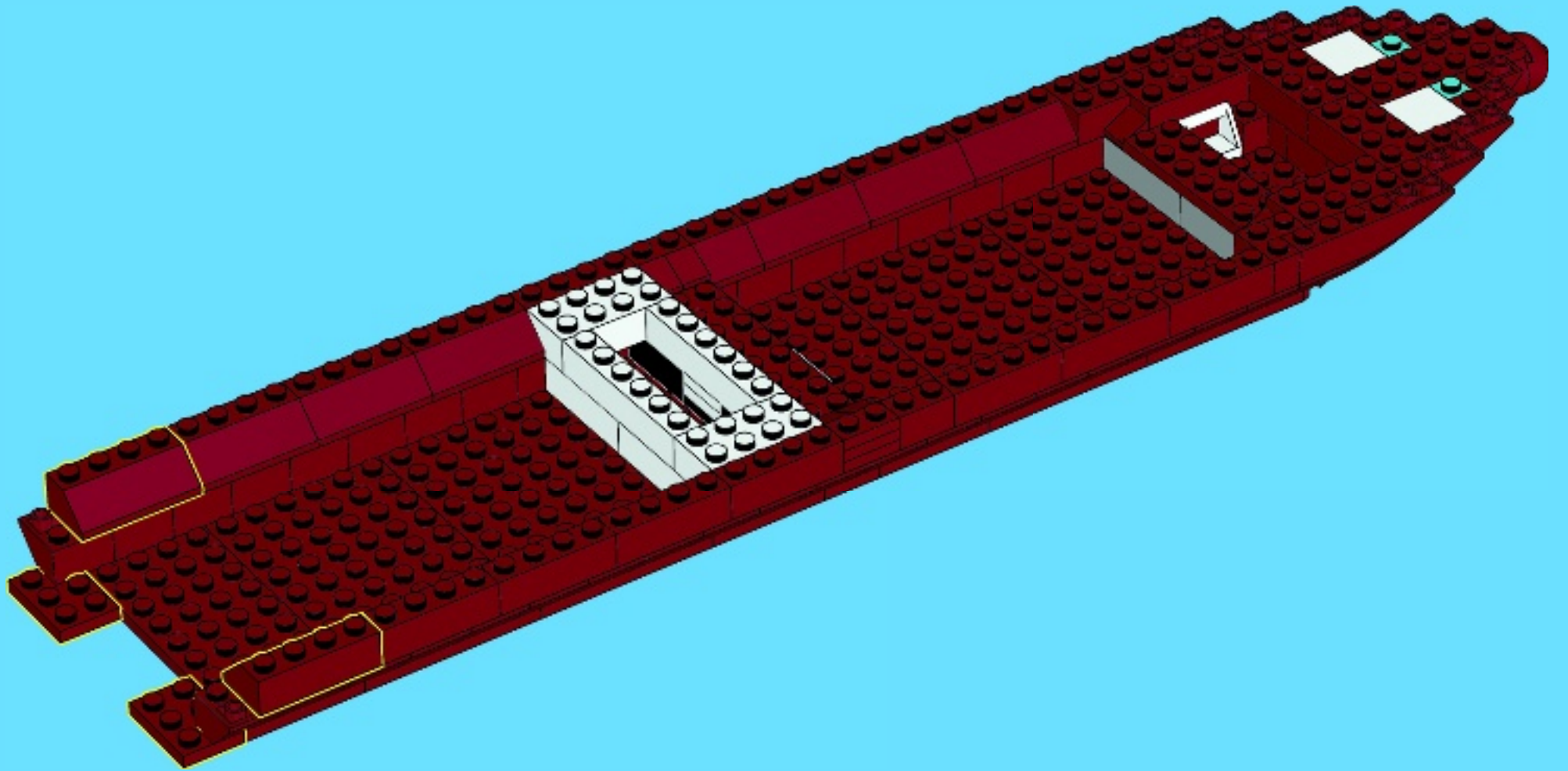



32

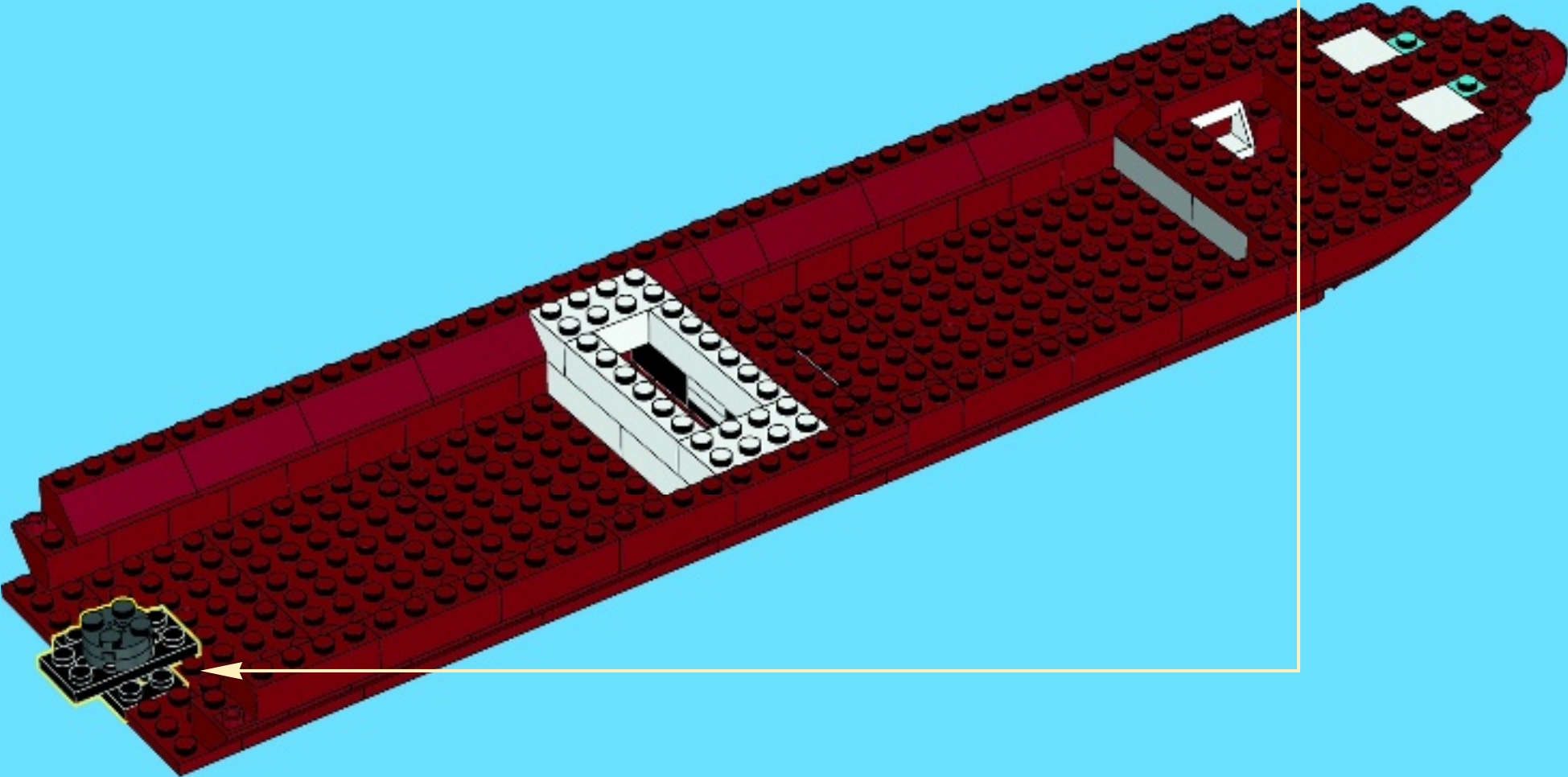
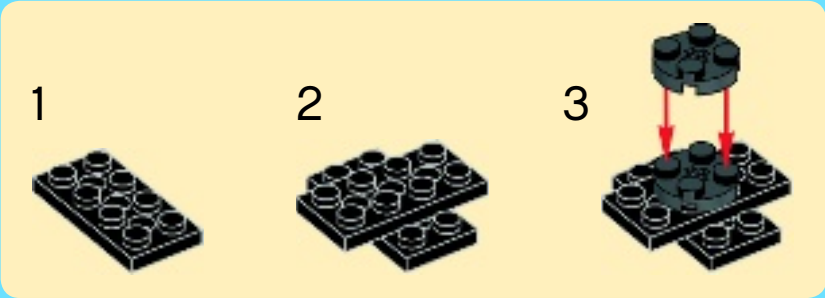

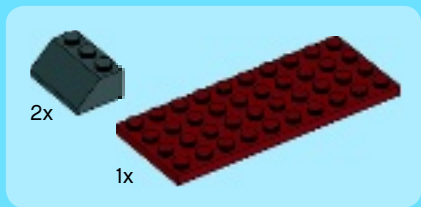

33

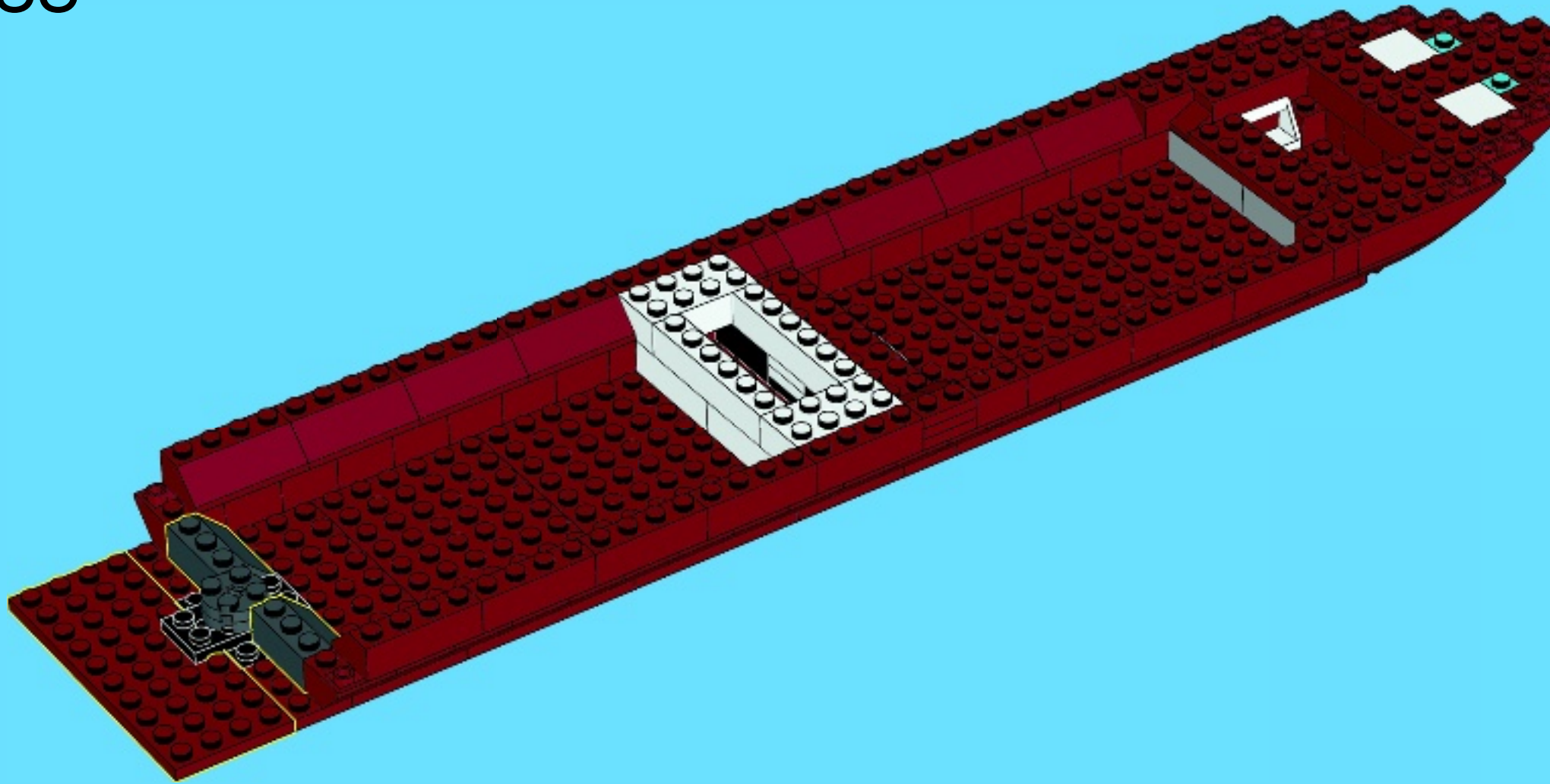



2x



6x

34

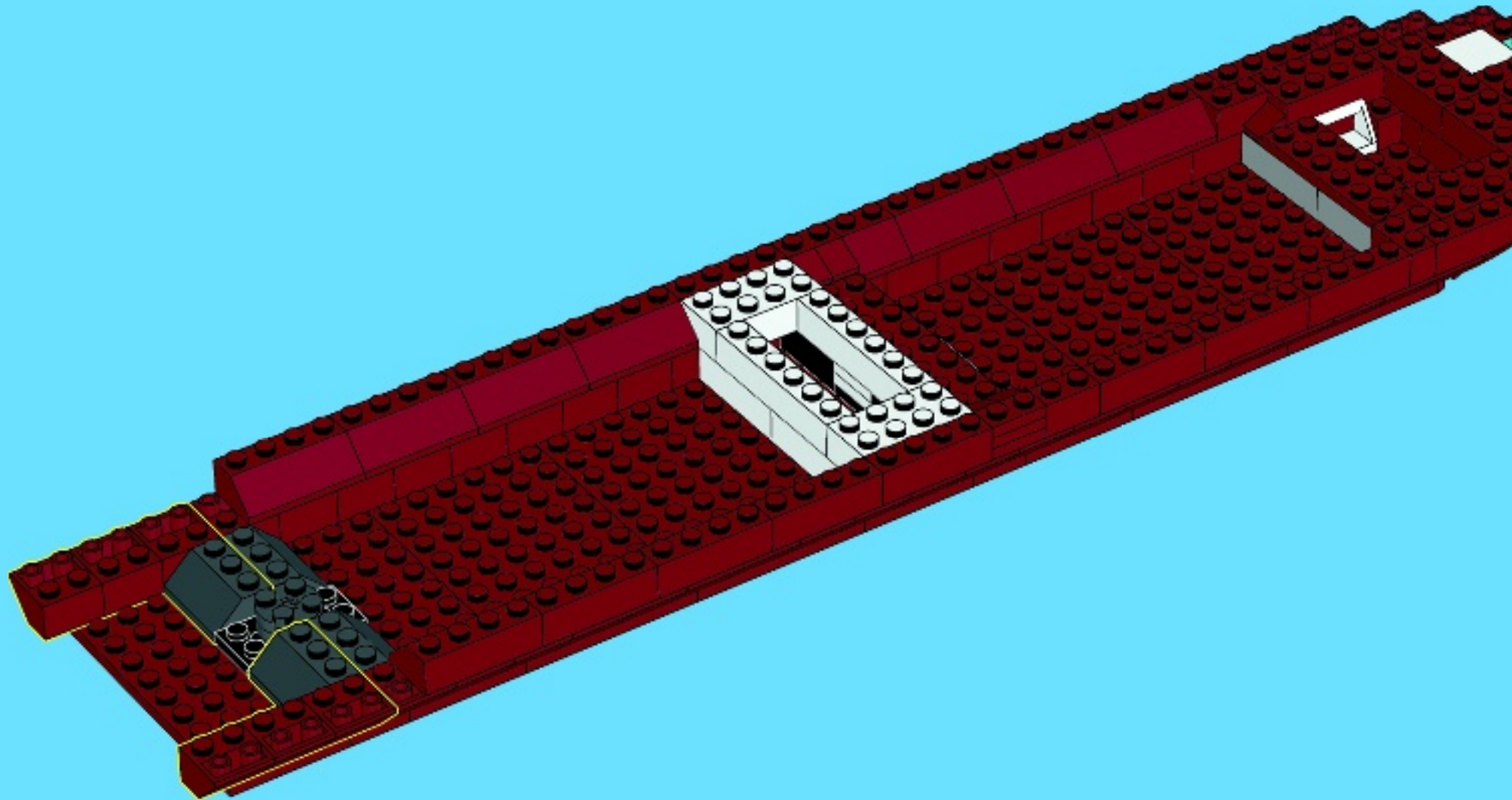

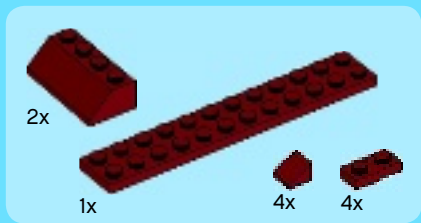

35

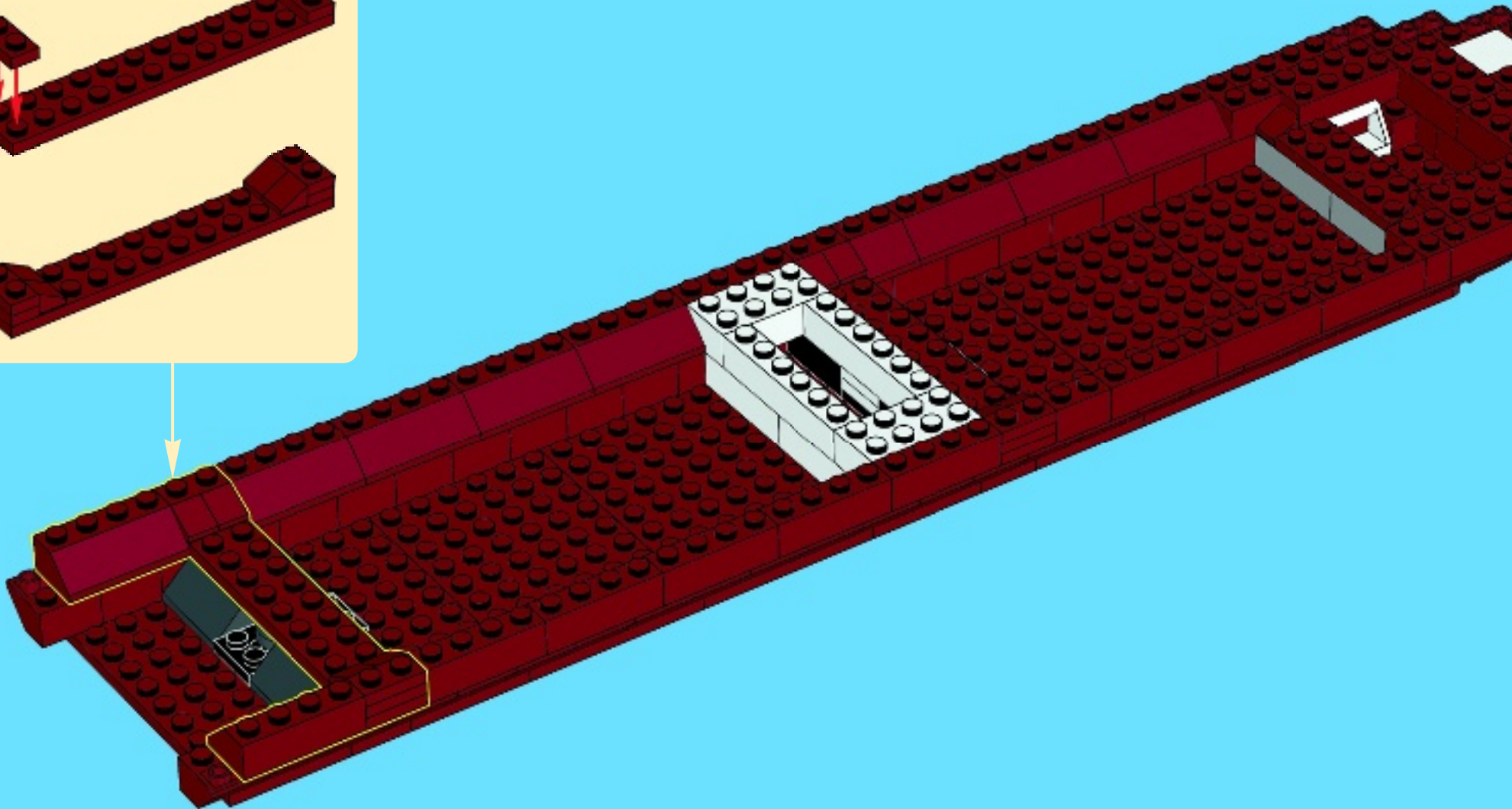
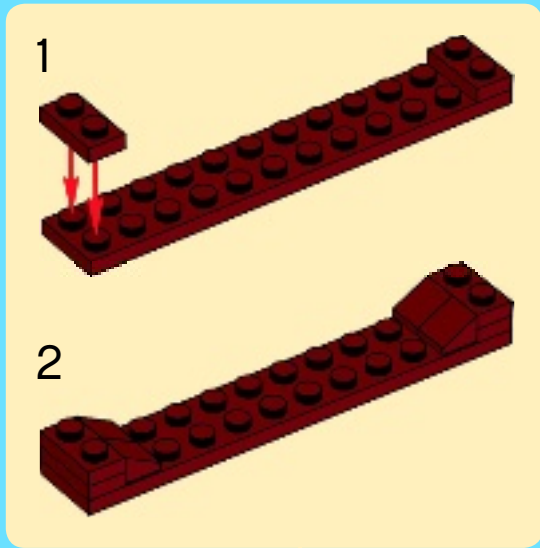



36

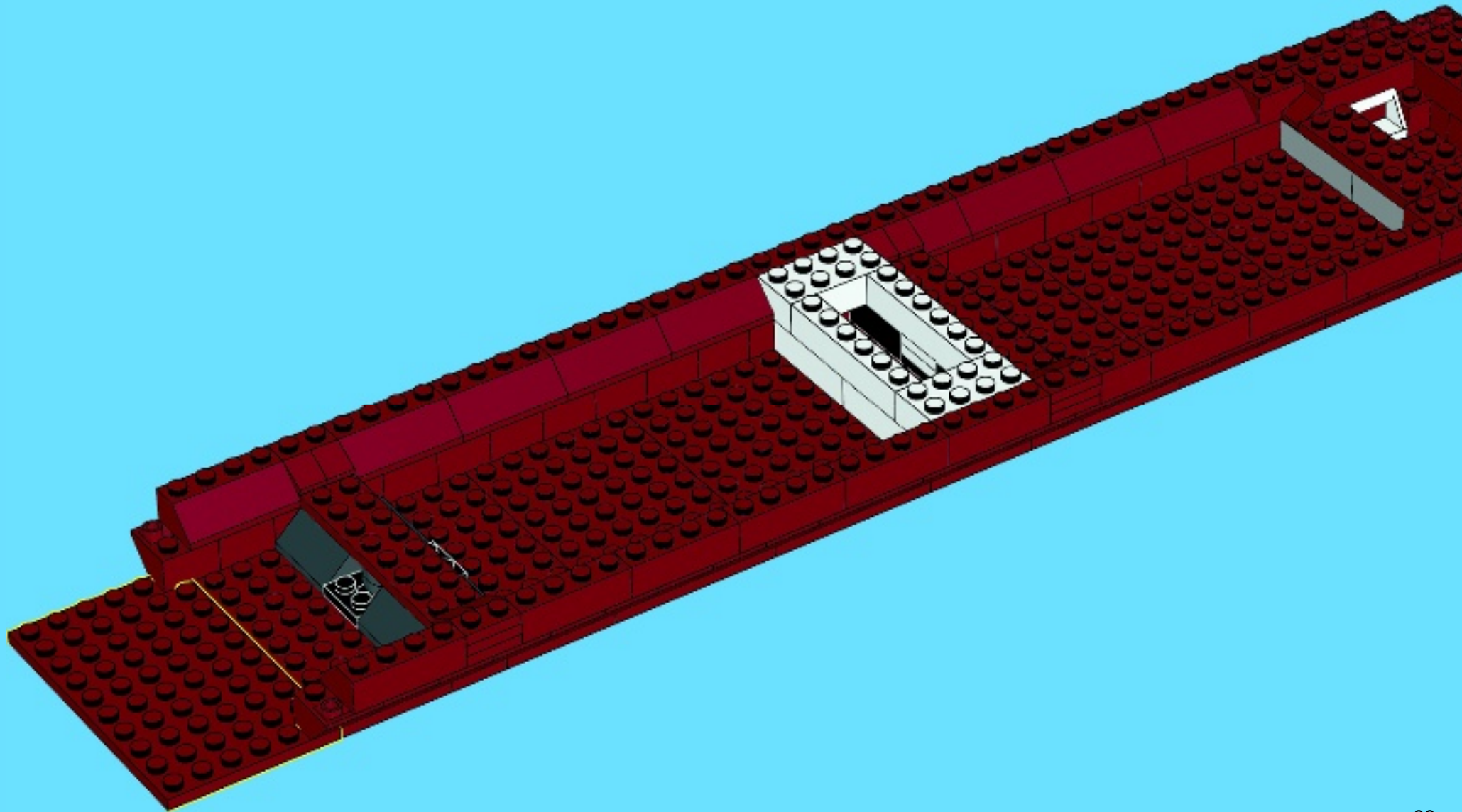



6x

37

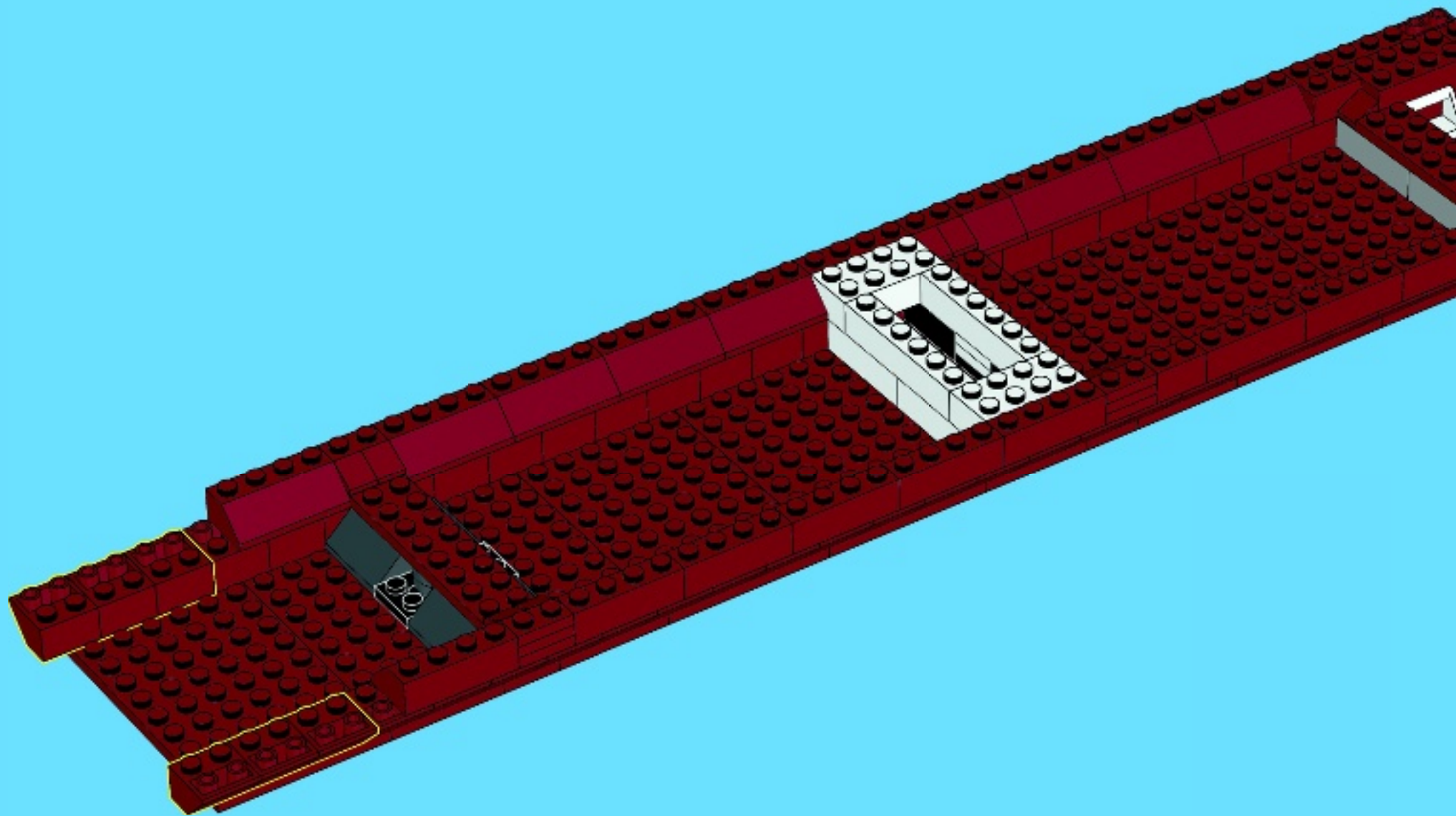

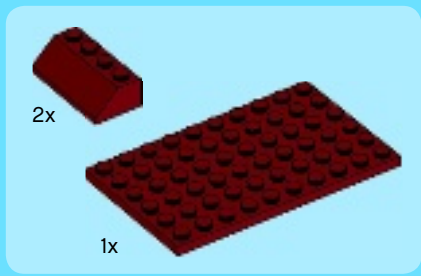

38

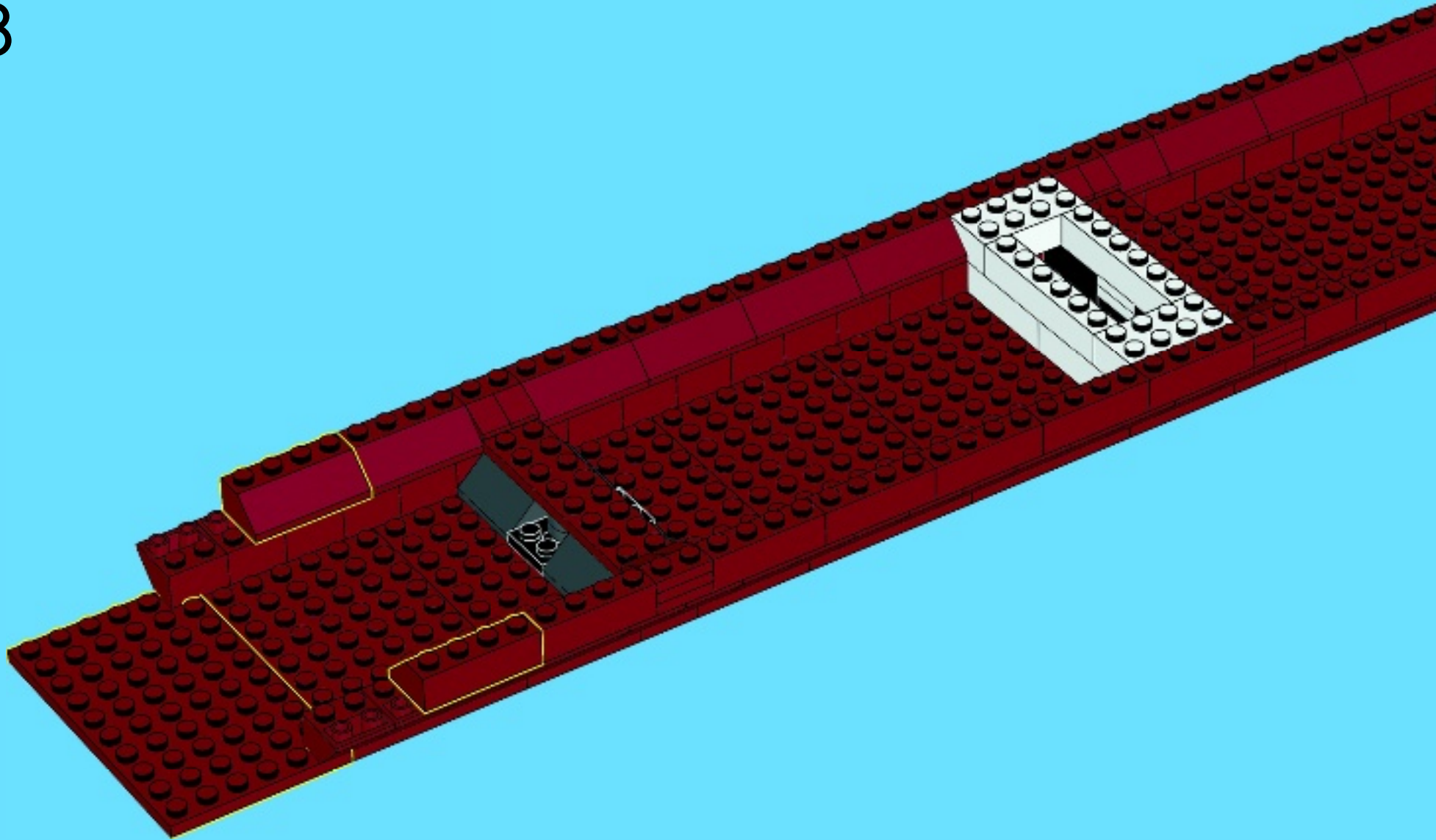



4x

39

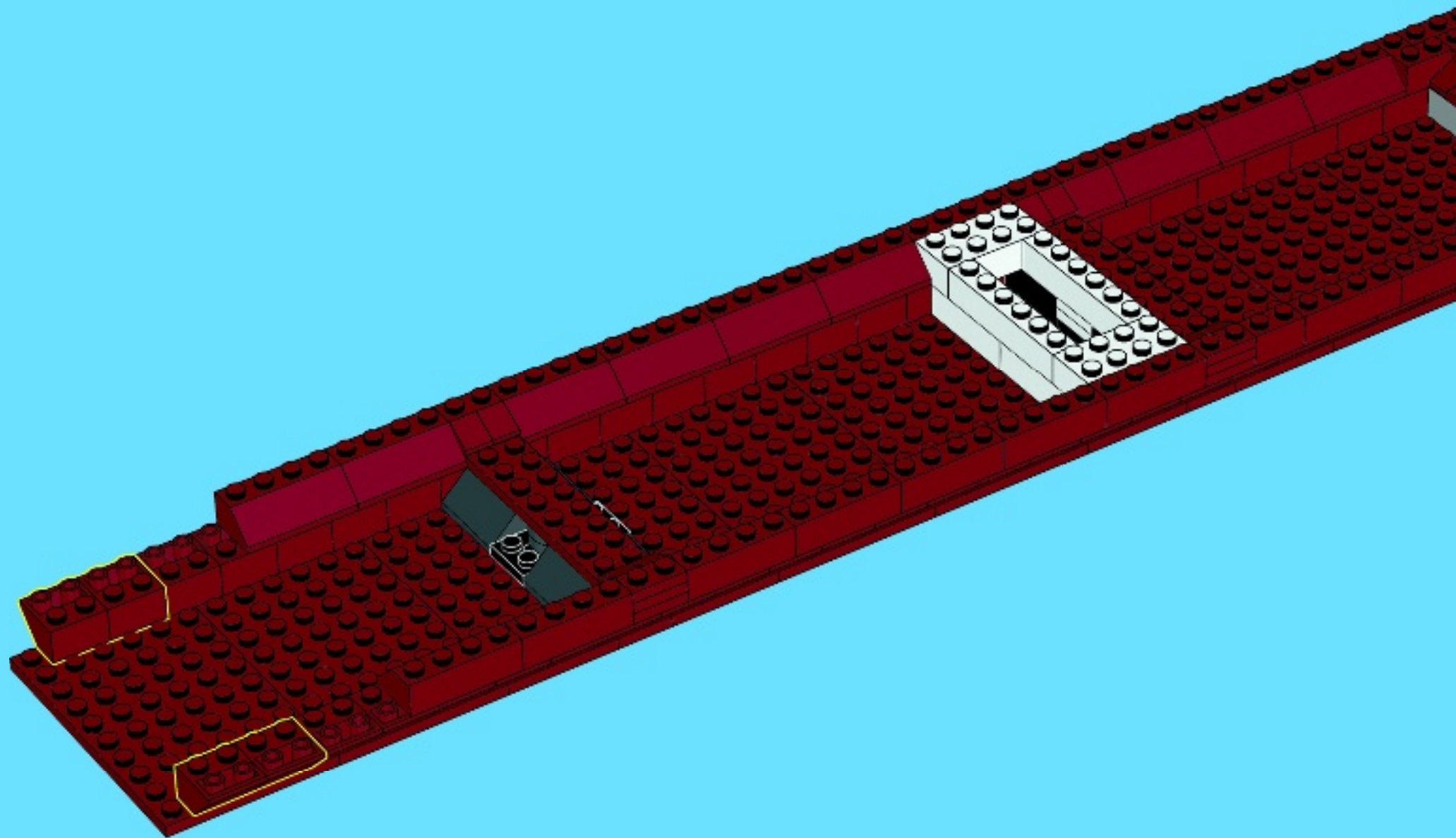



6x



4x



4x

40

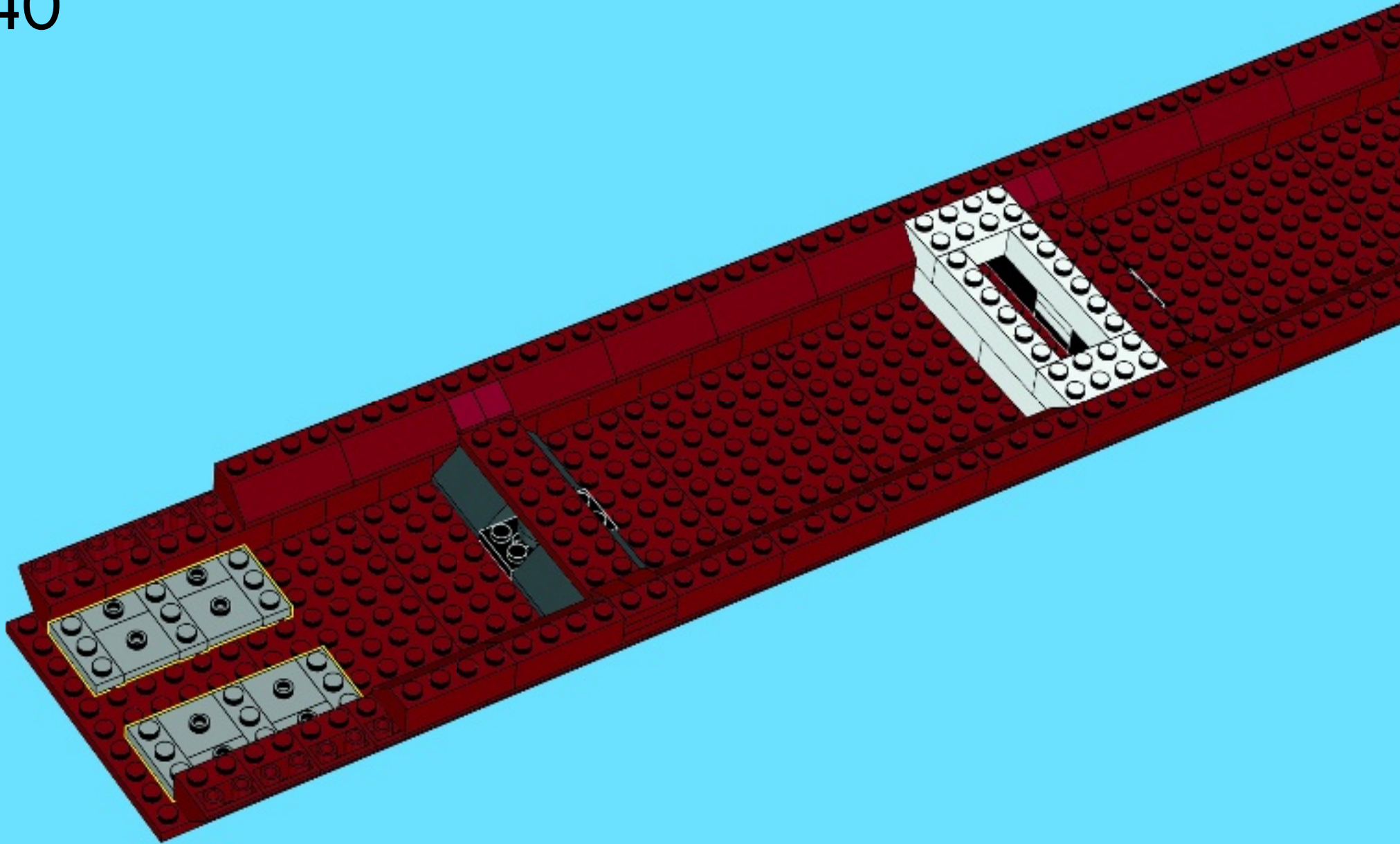



10x



10x

41

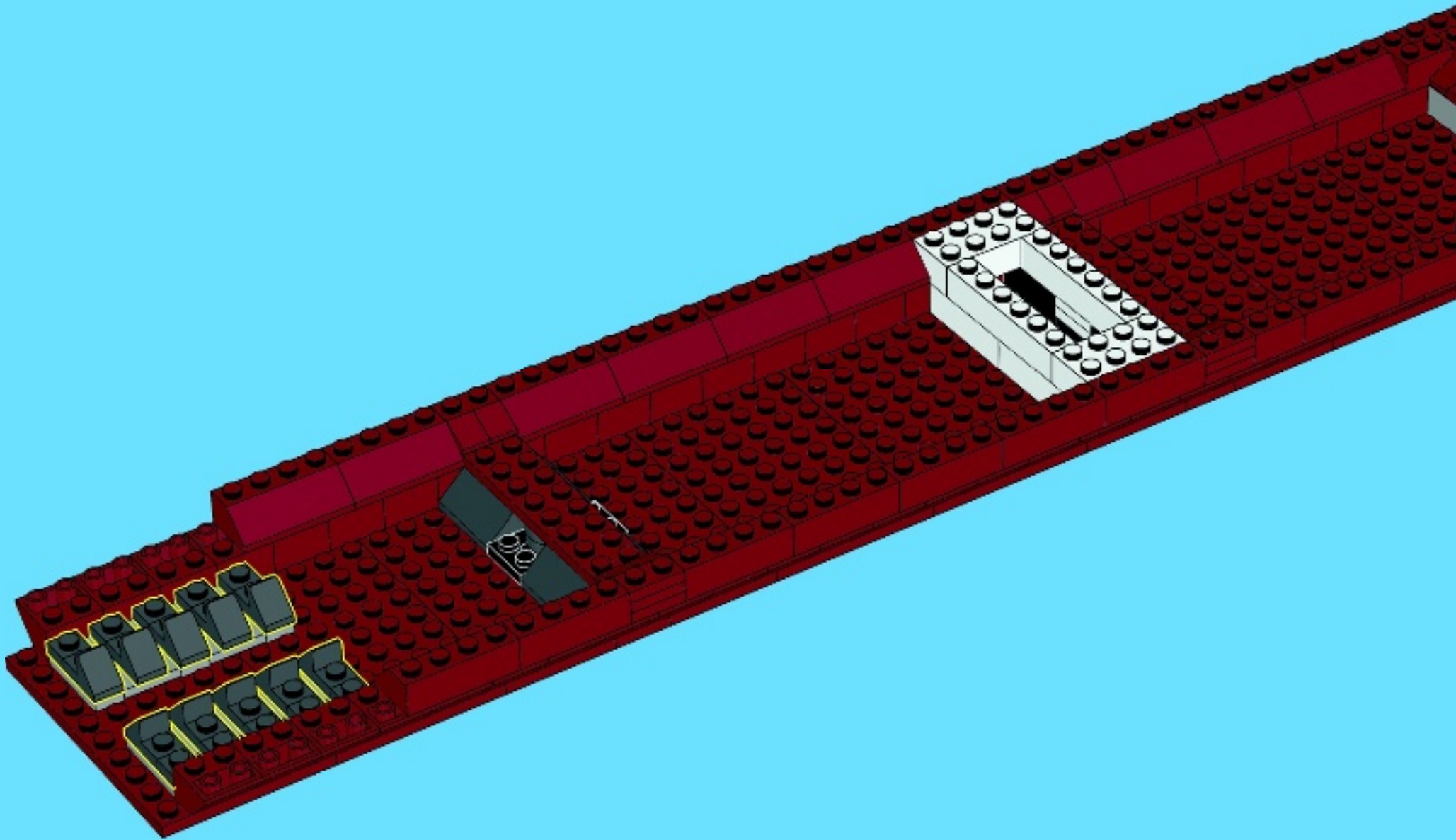

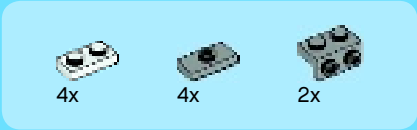

42

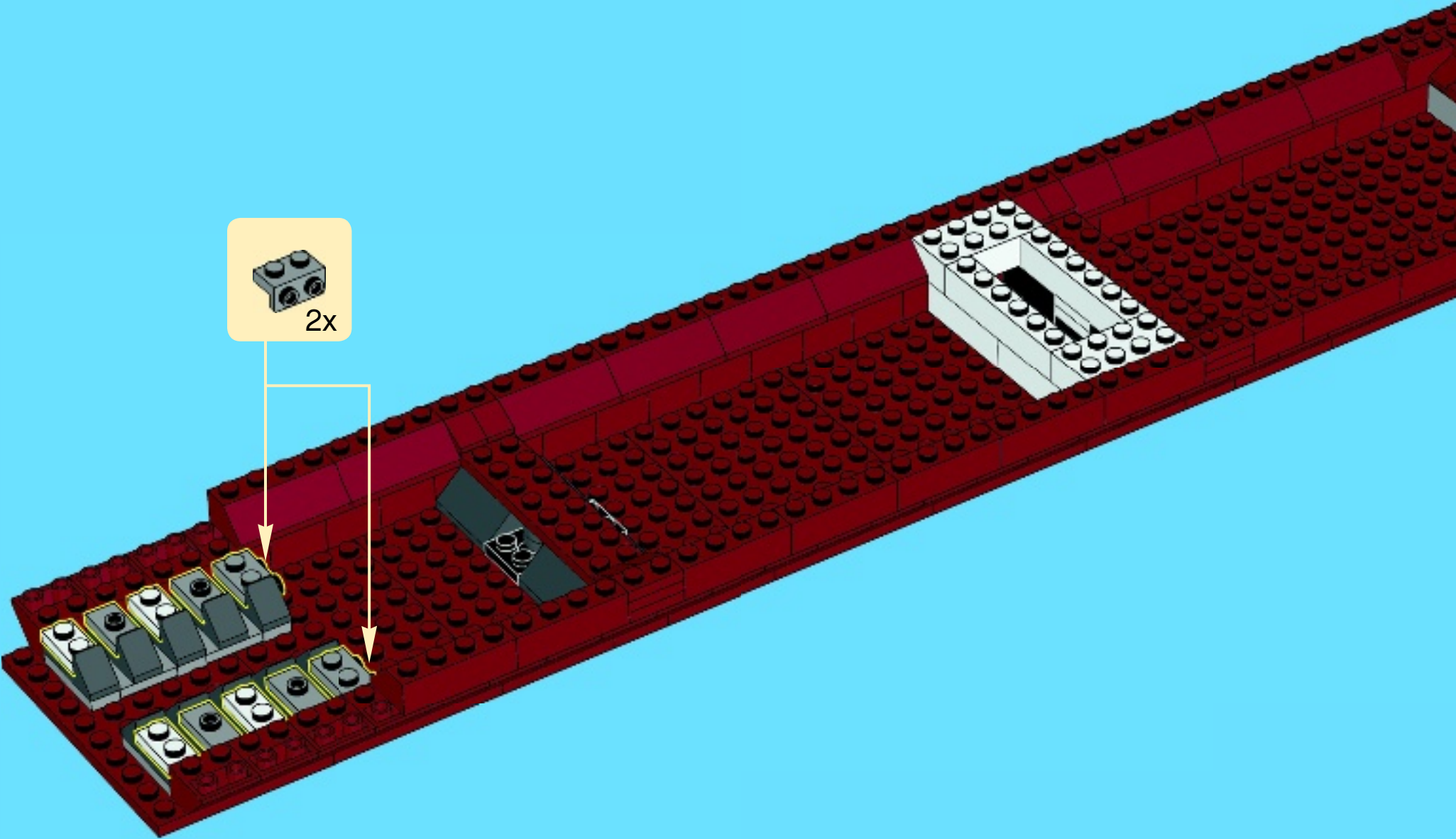



2x

43

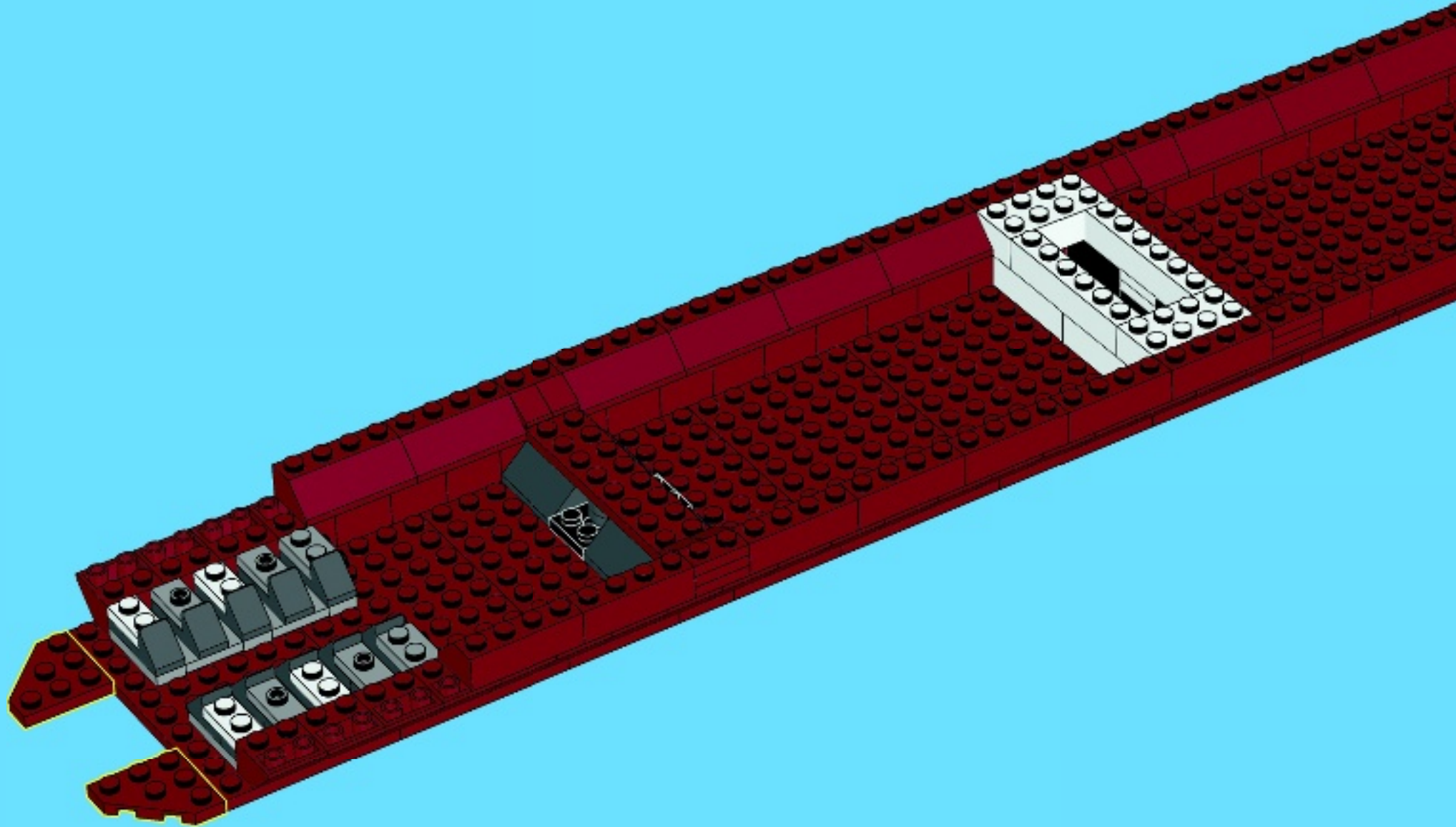

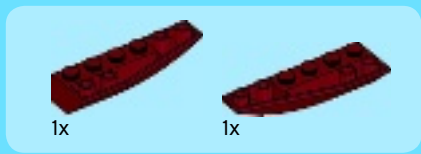

44

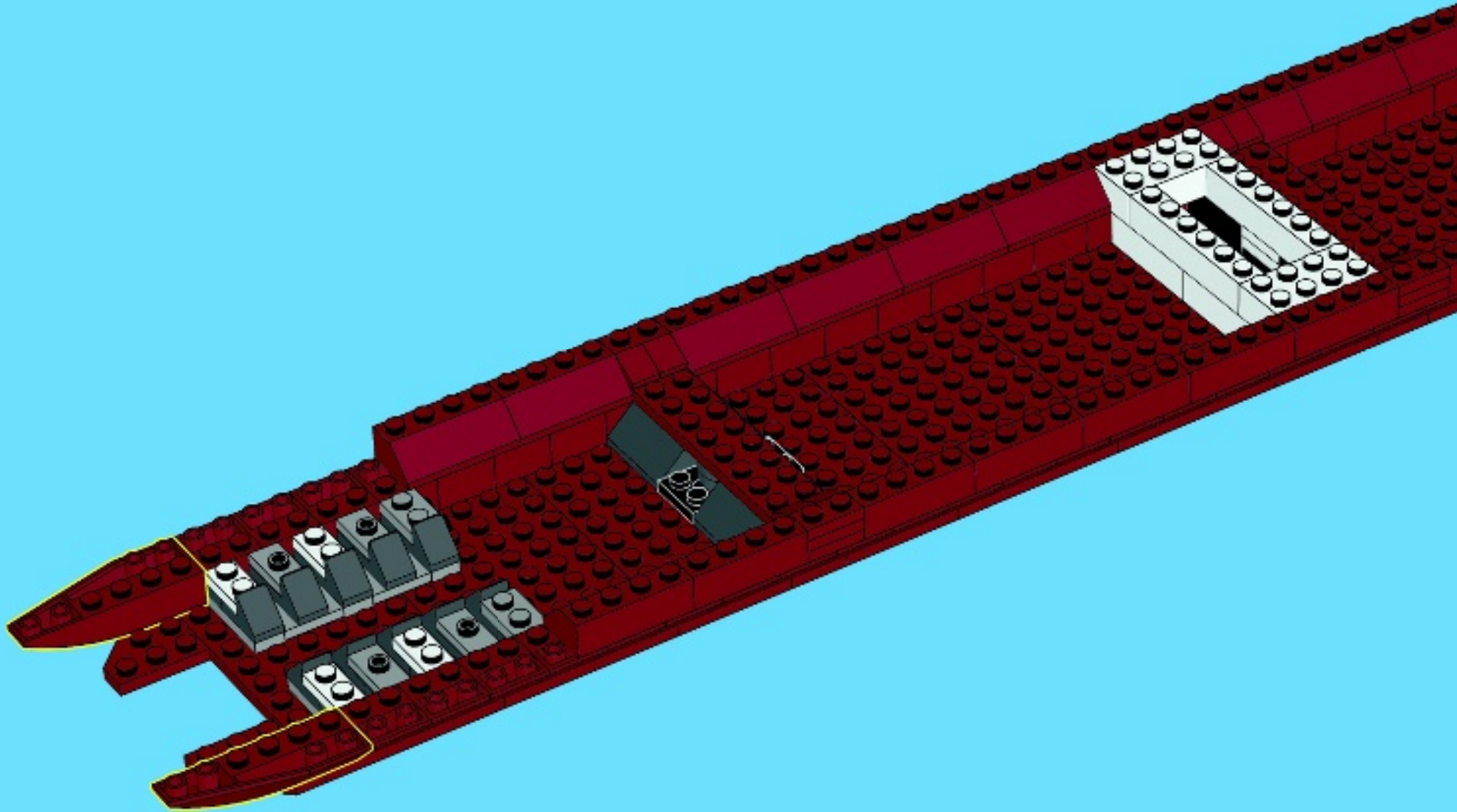

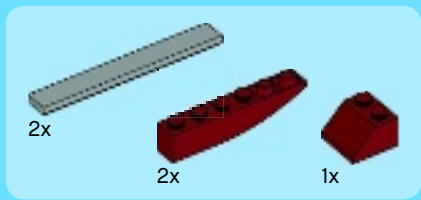

45

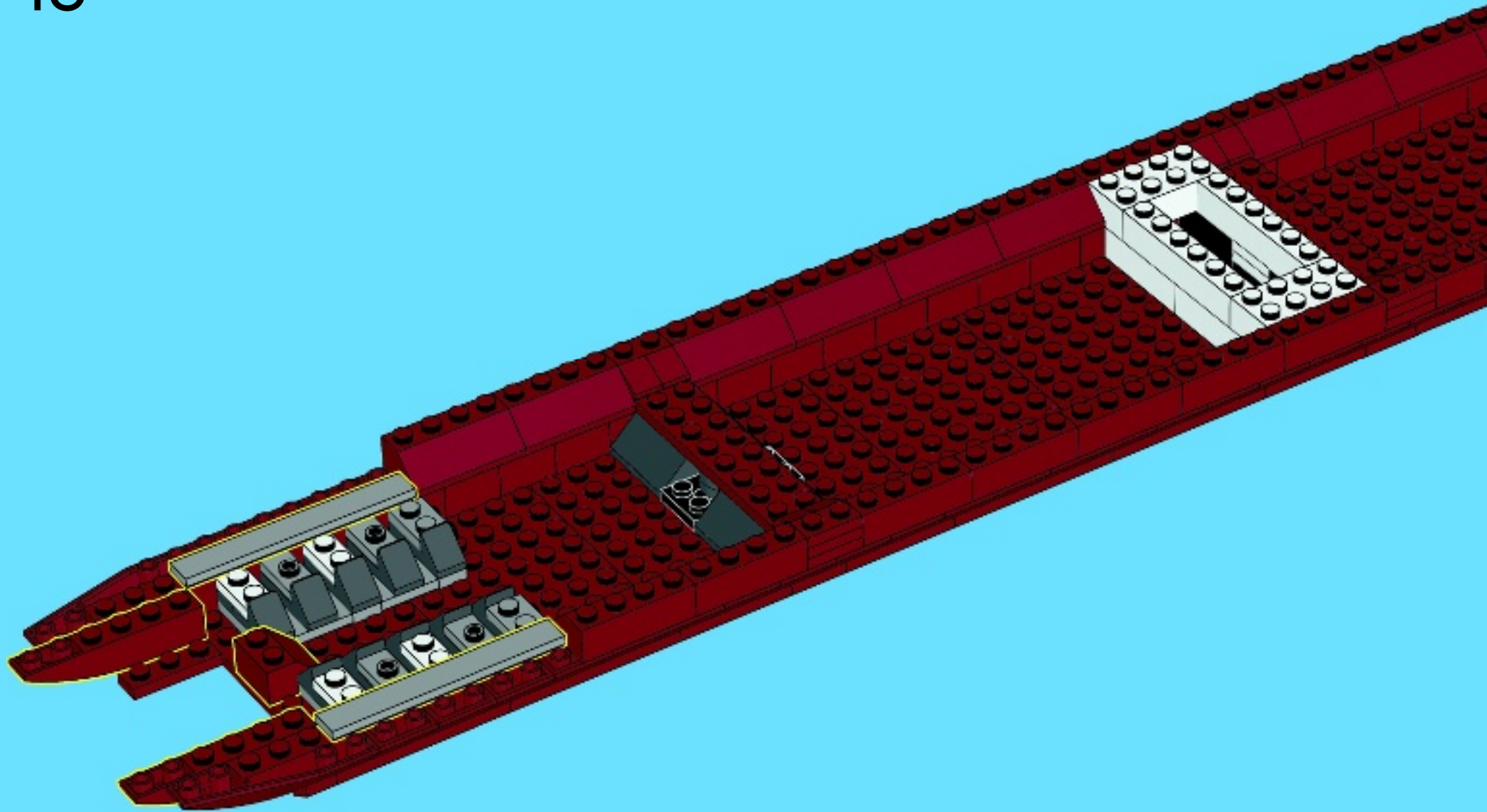

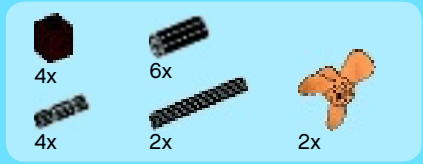

46

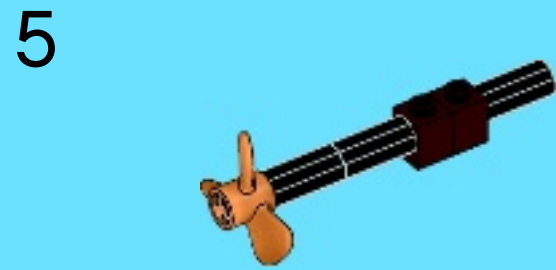
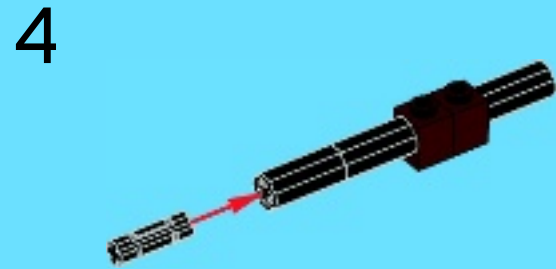
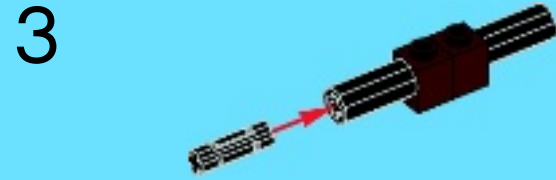
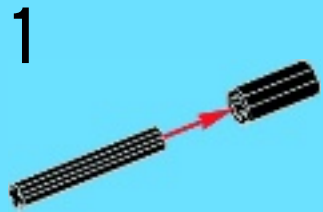

2x

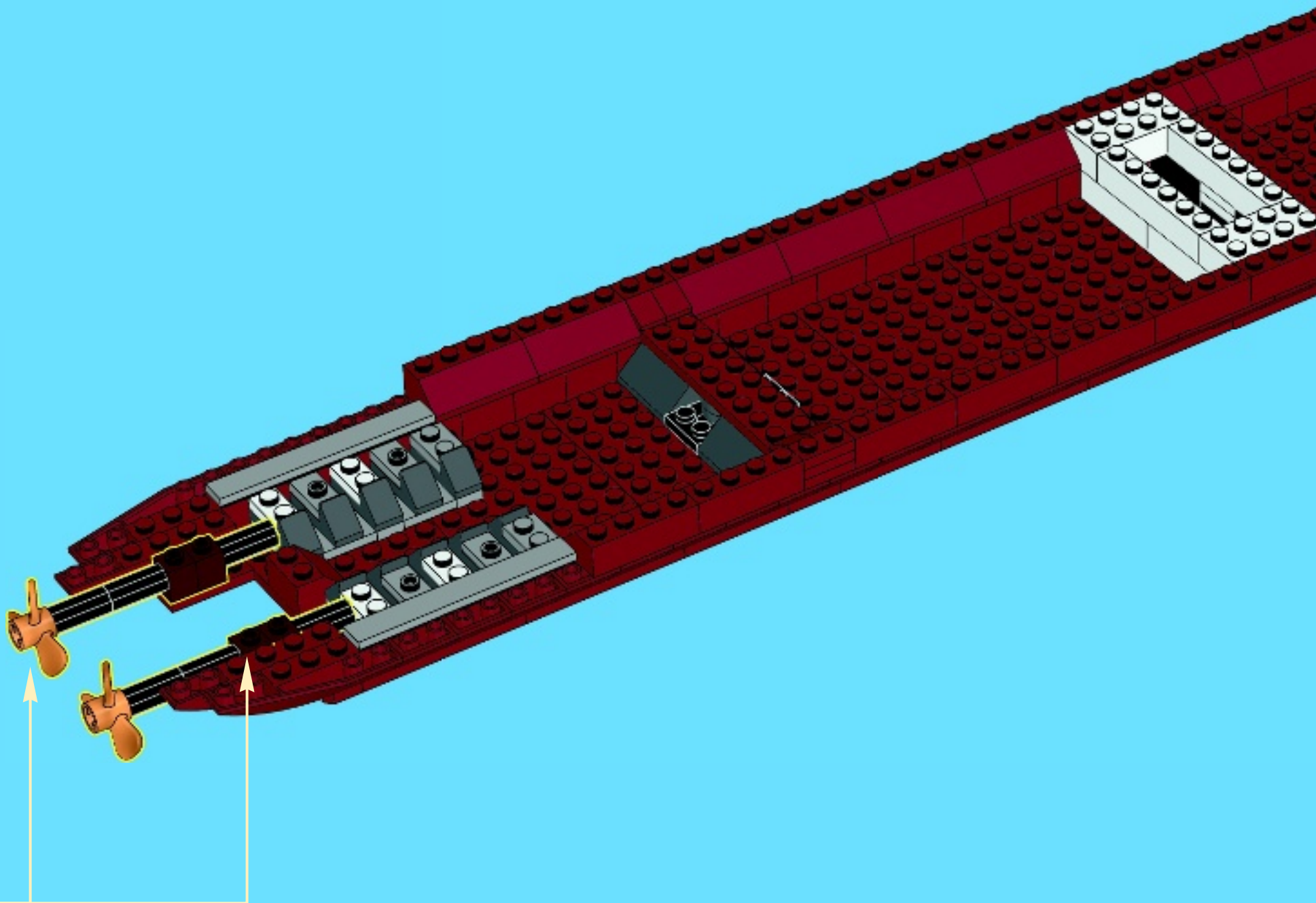

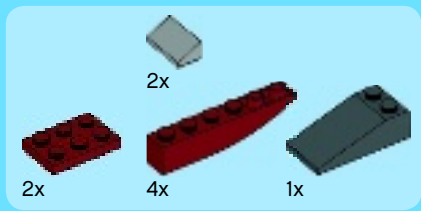

47

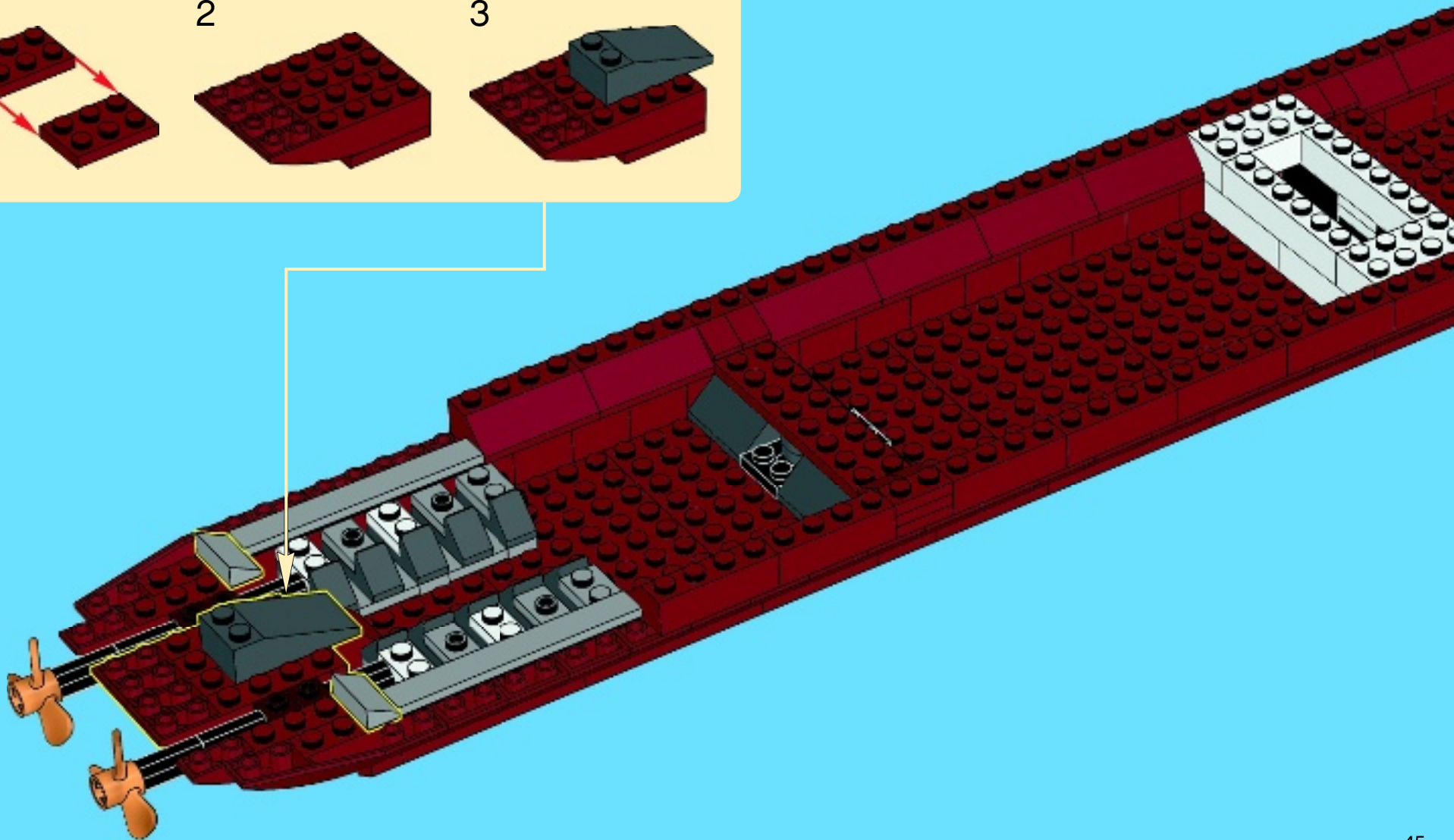

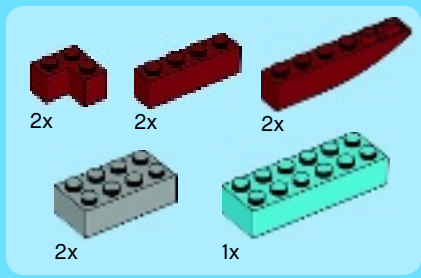

48

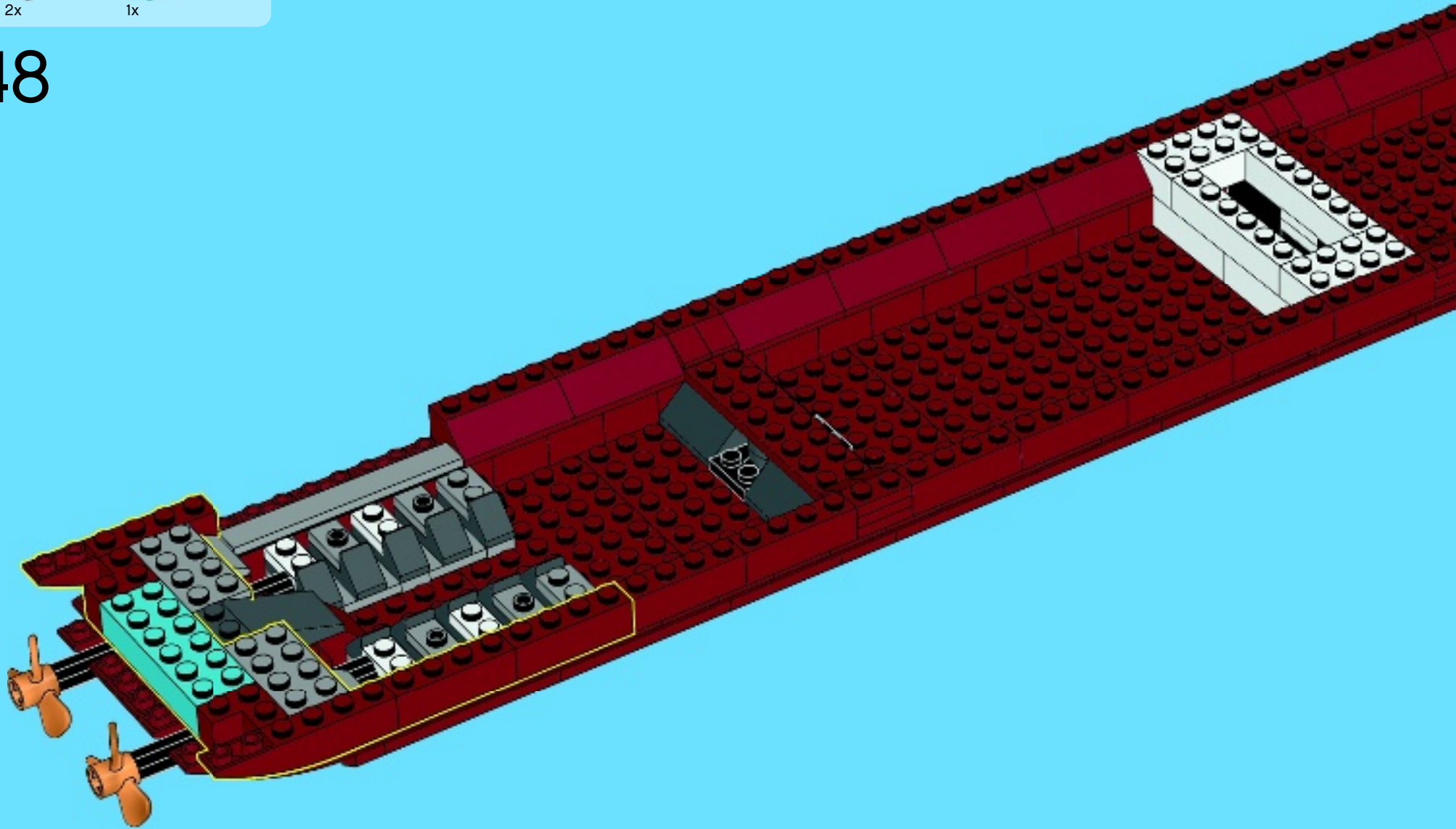

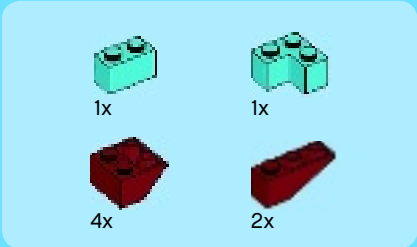

49

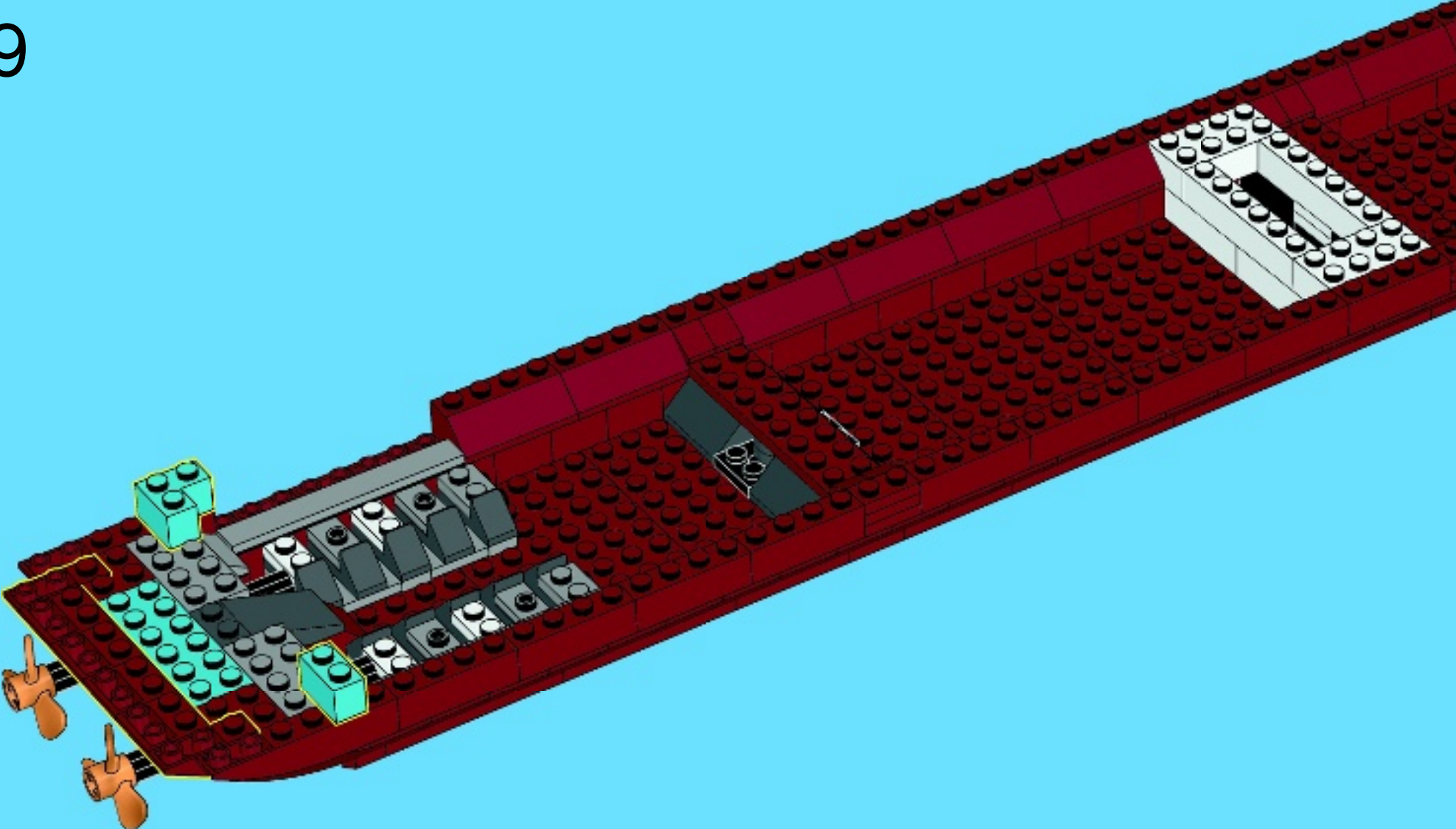

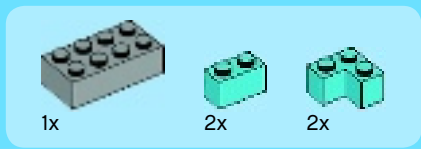

50

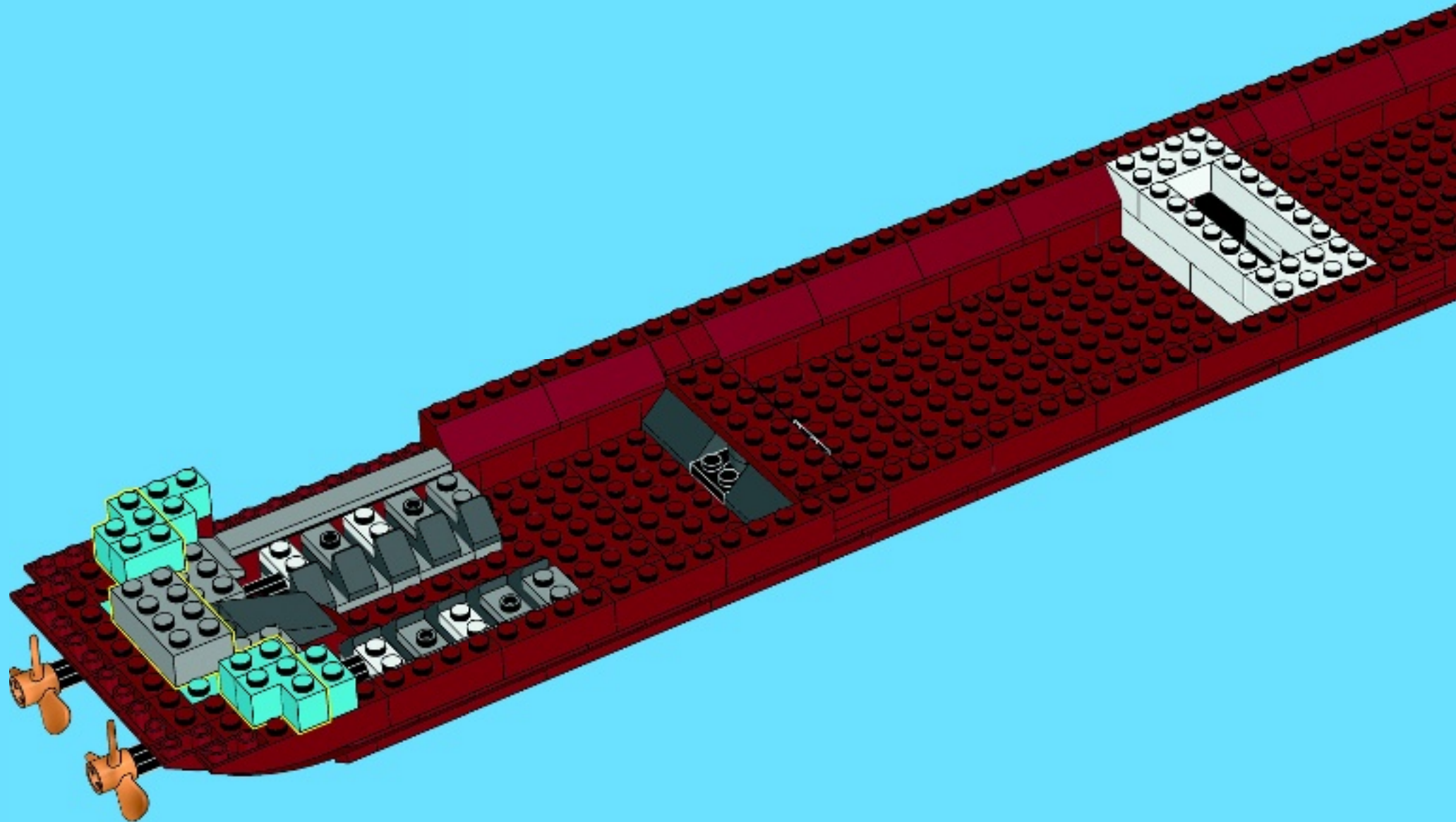

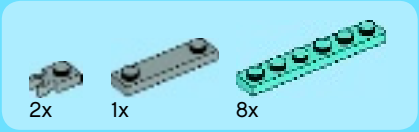

51

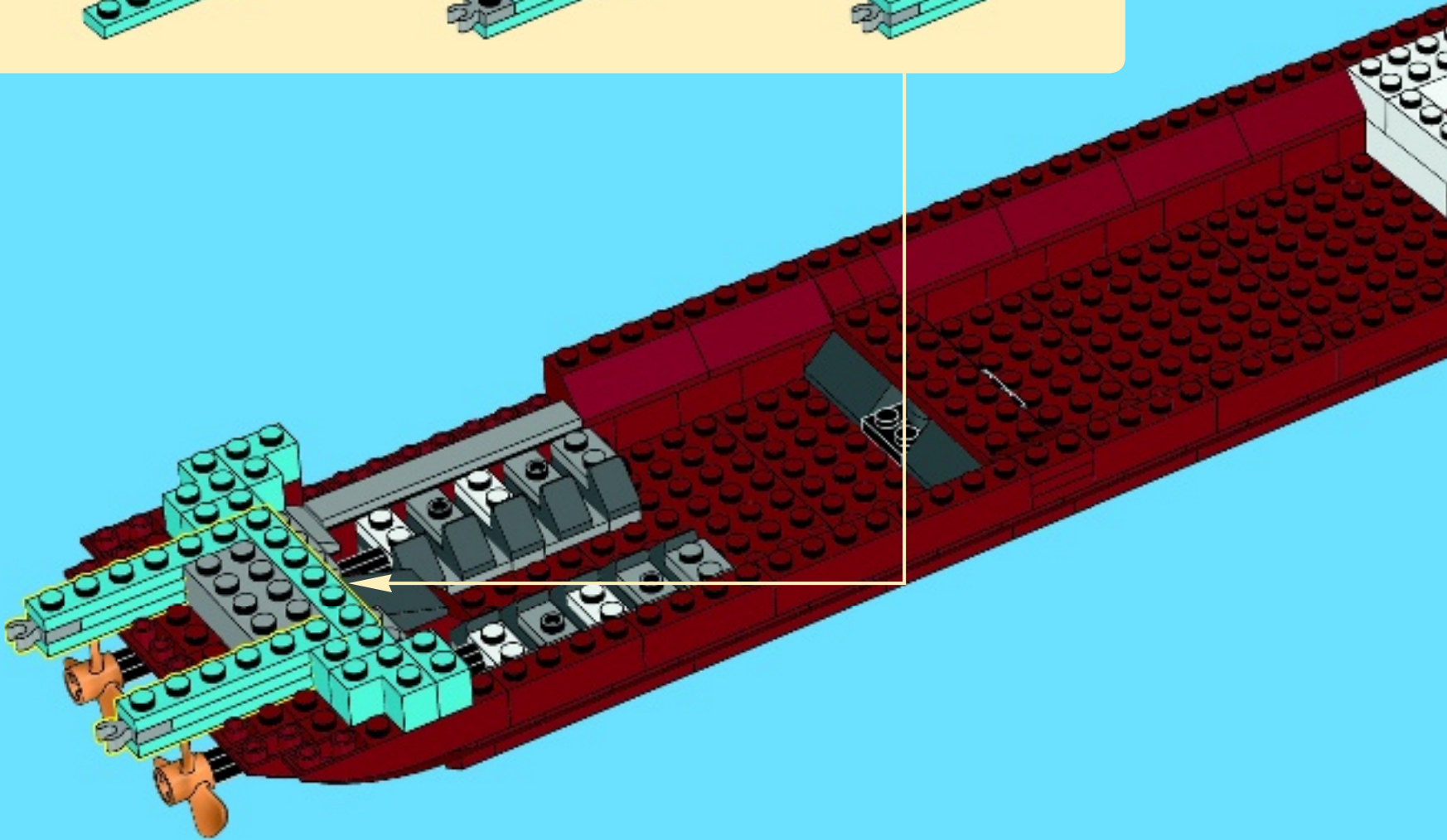
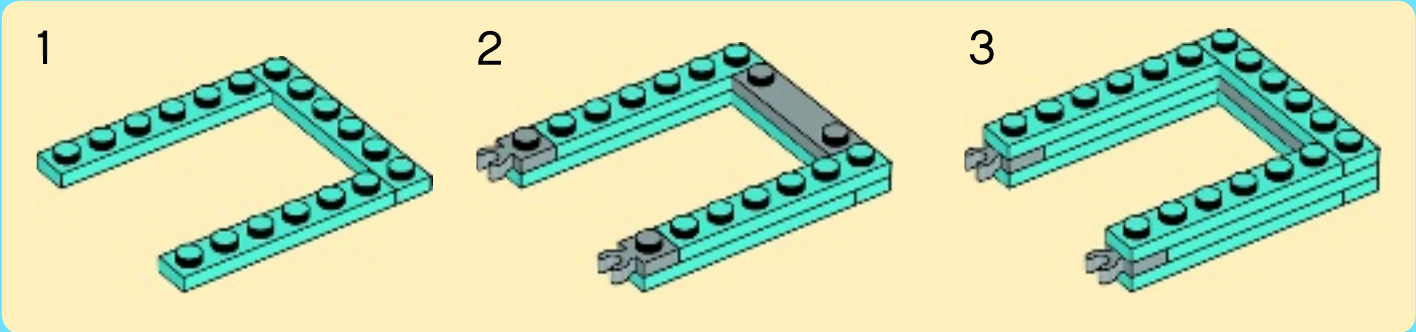

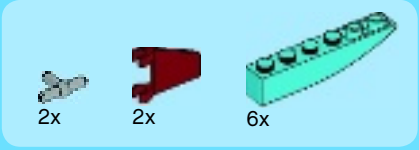

52

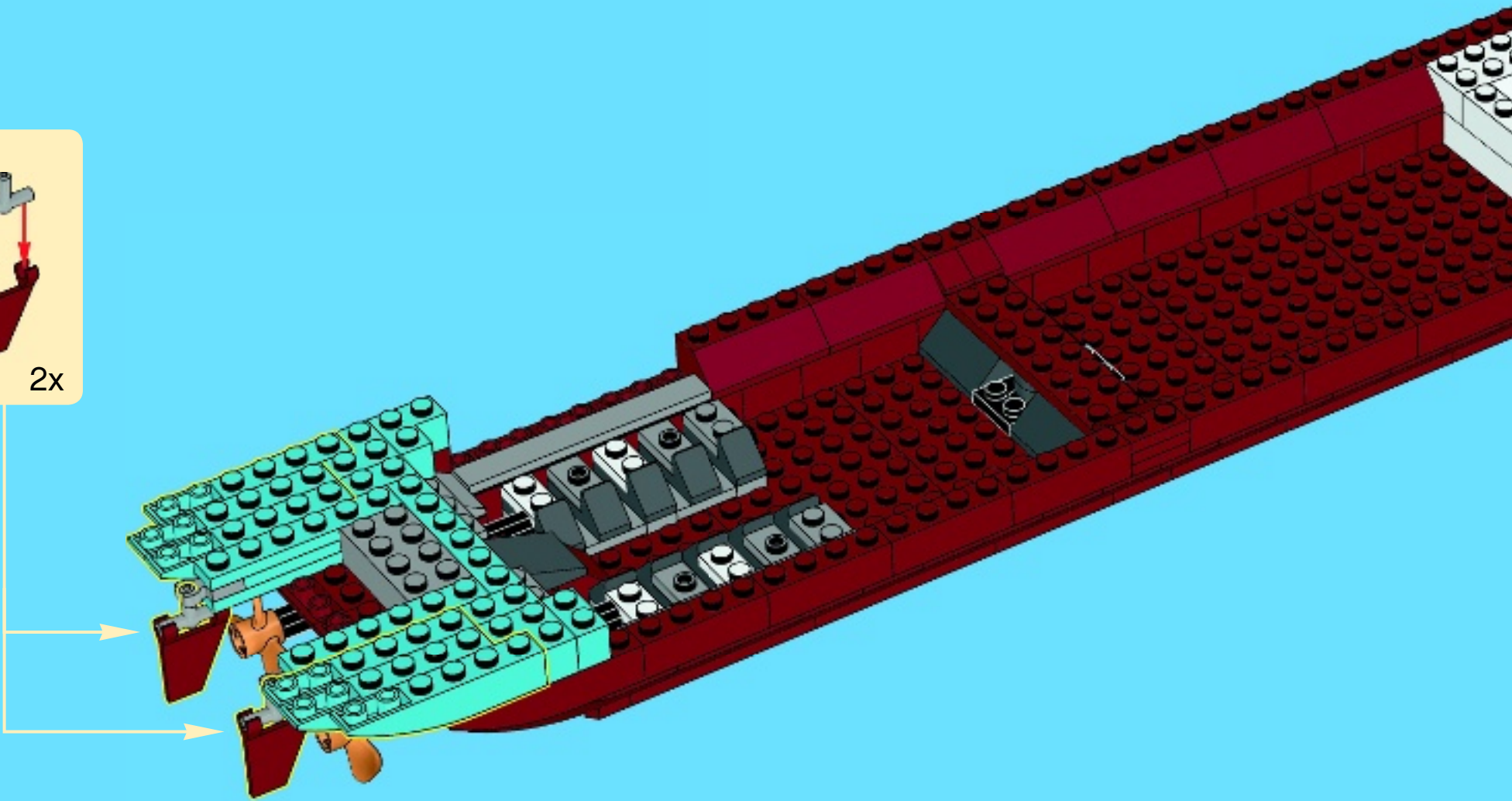
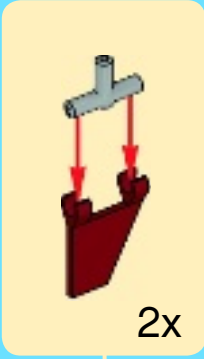

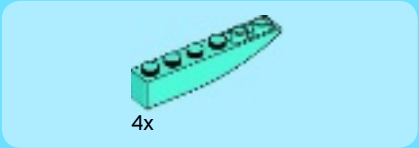

53

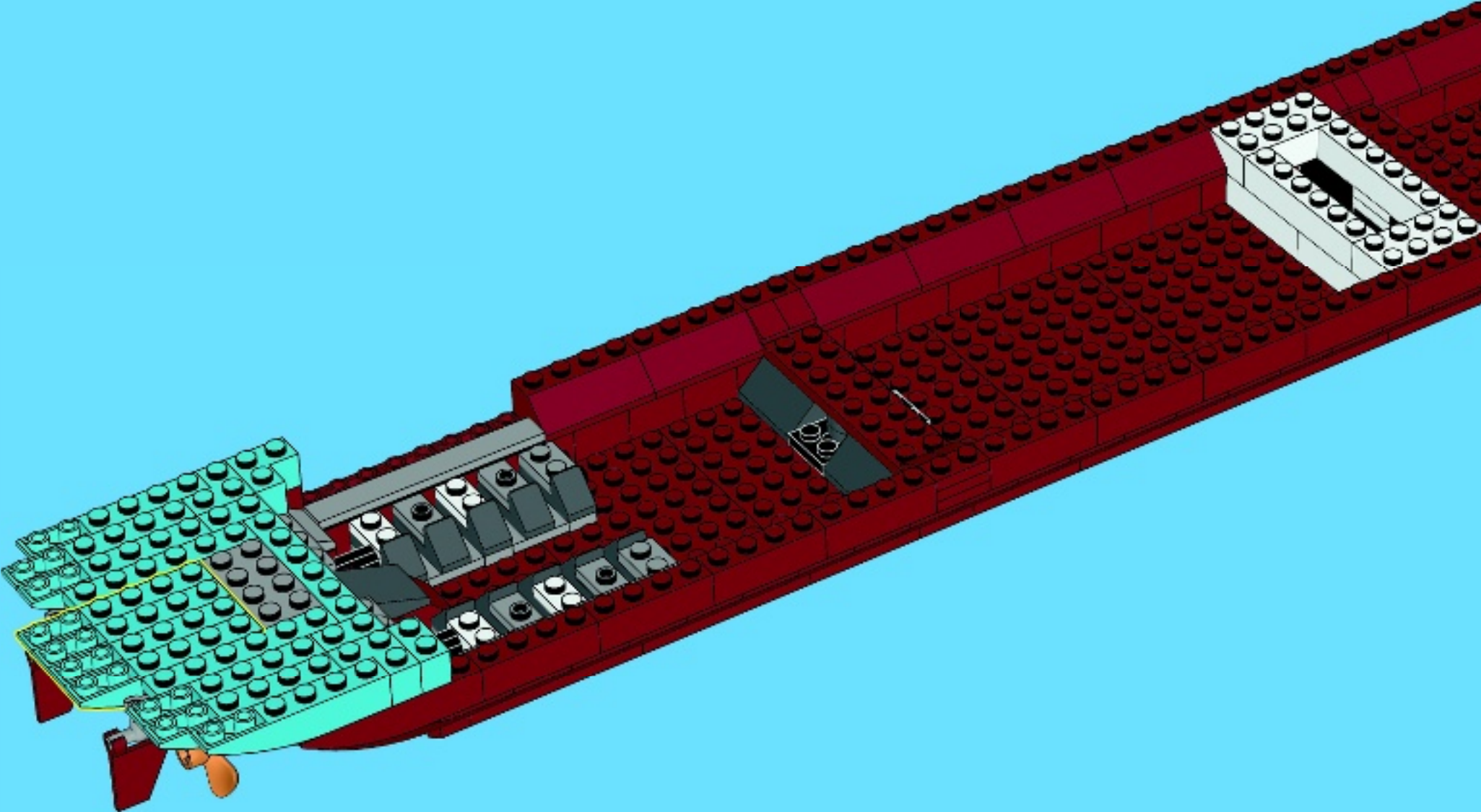

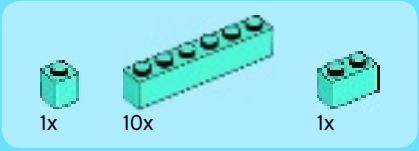

54

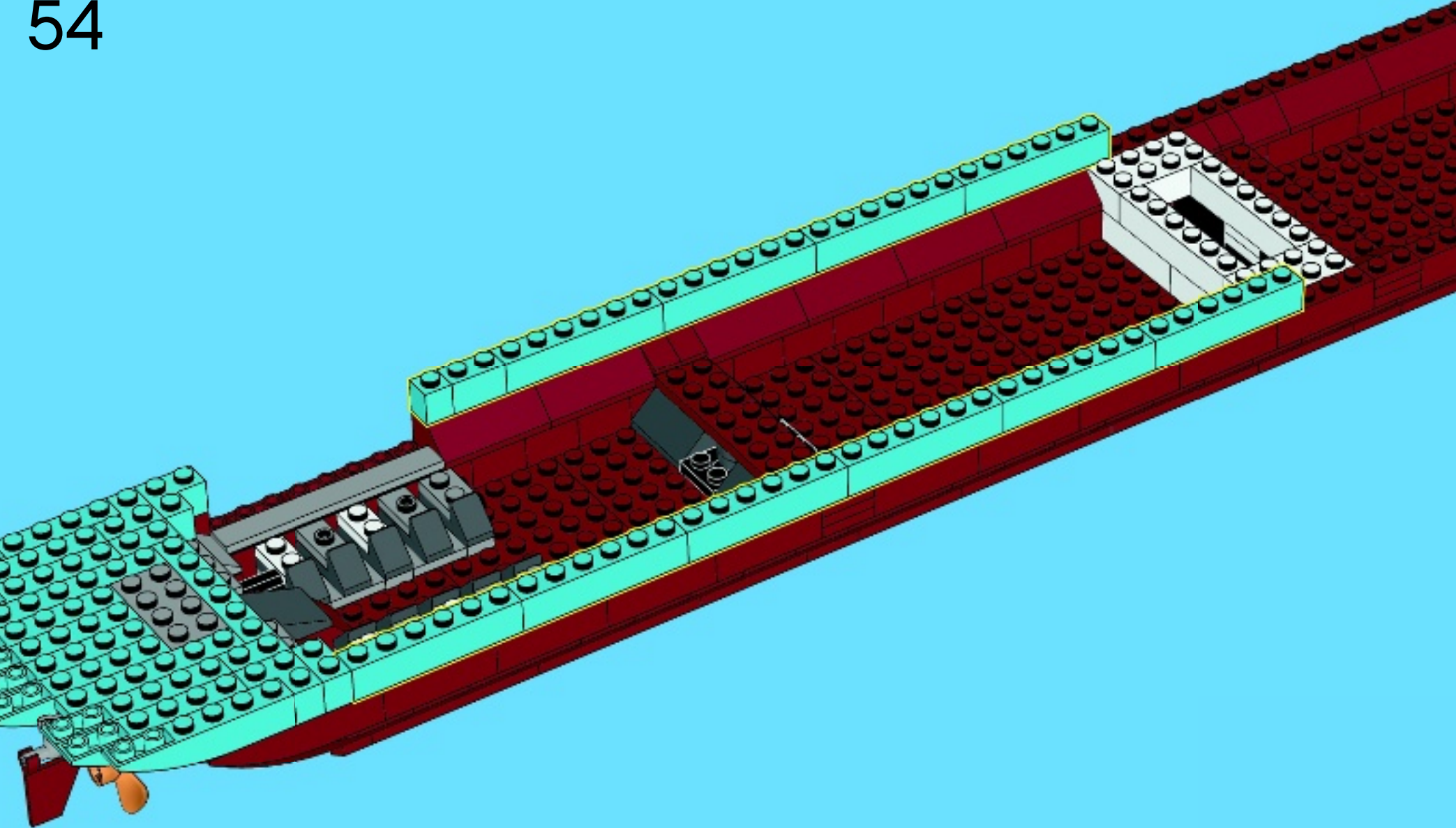

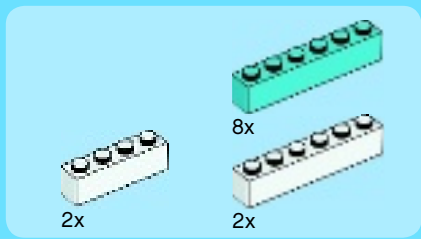

55

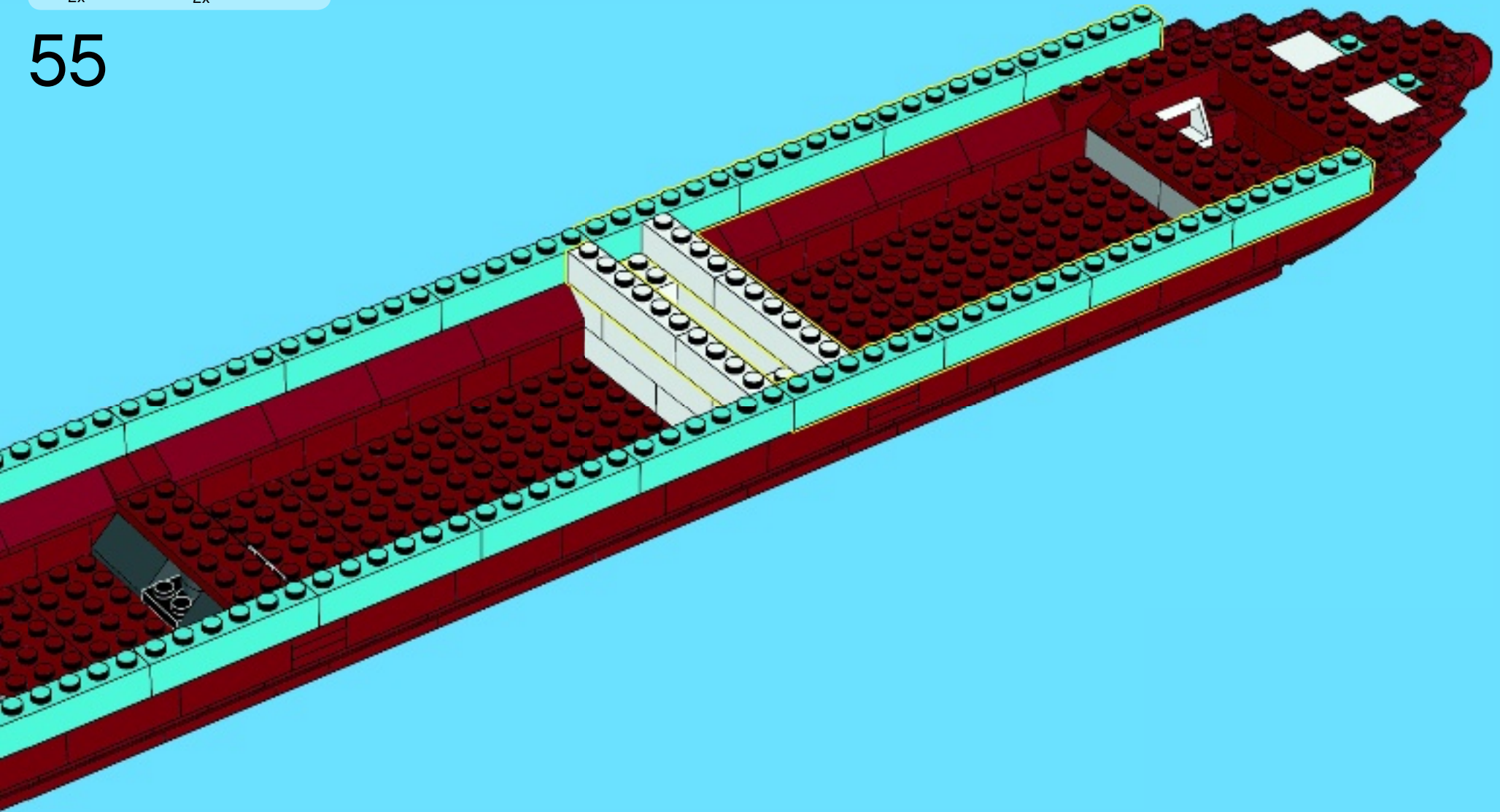

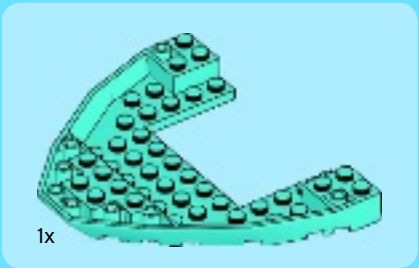

56

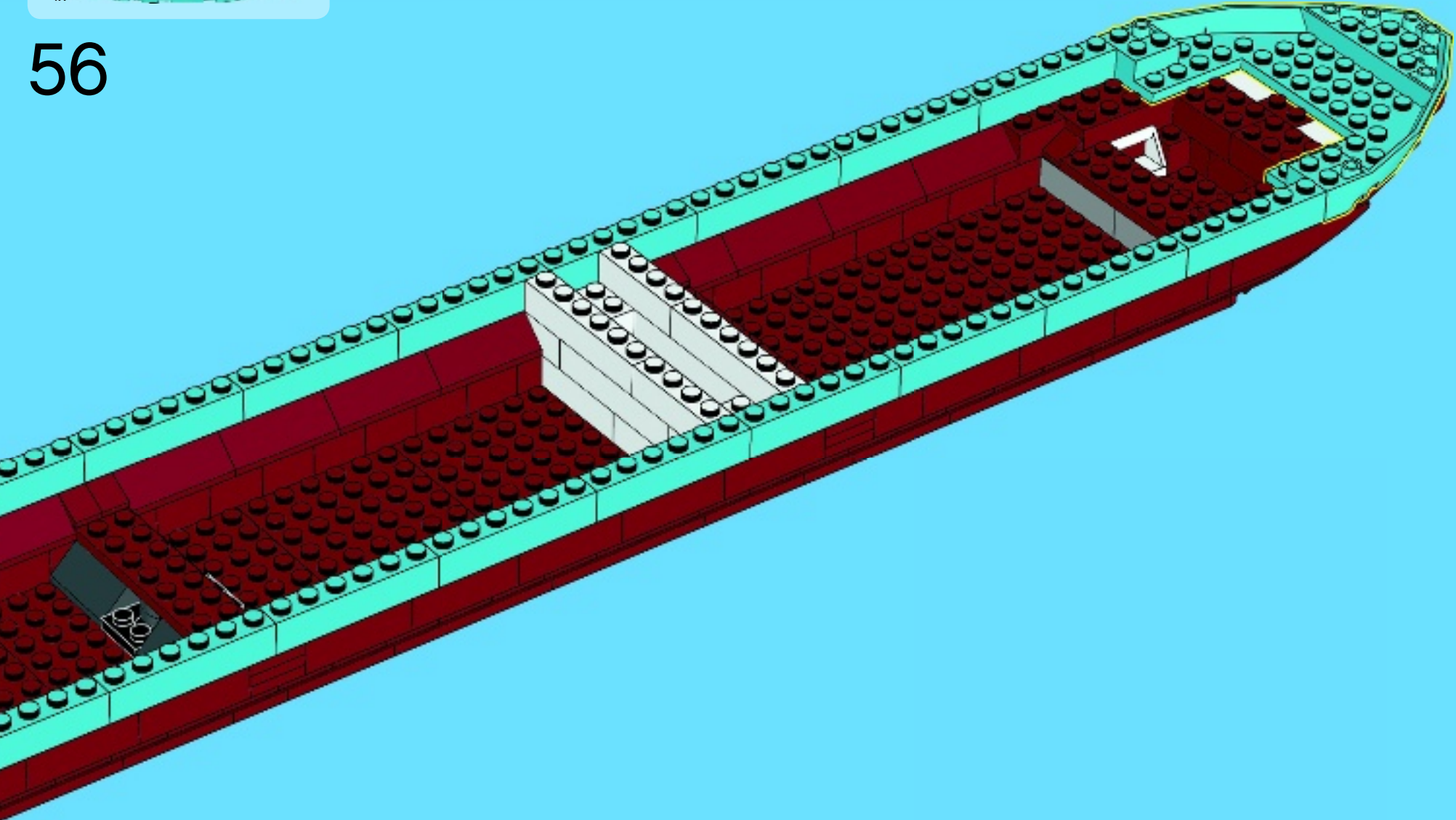

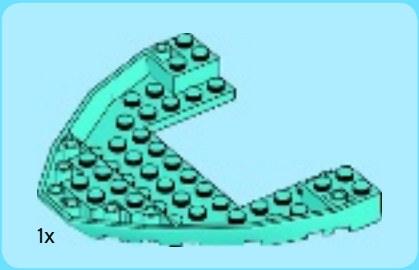

57

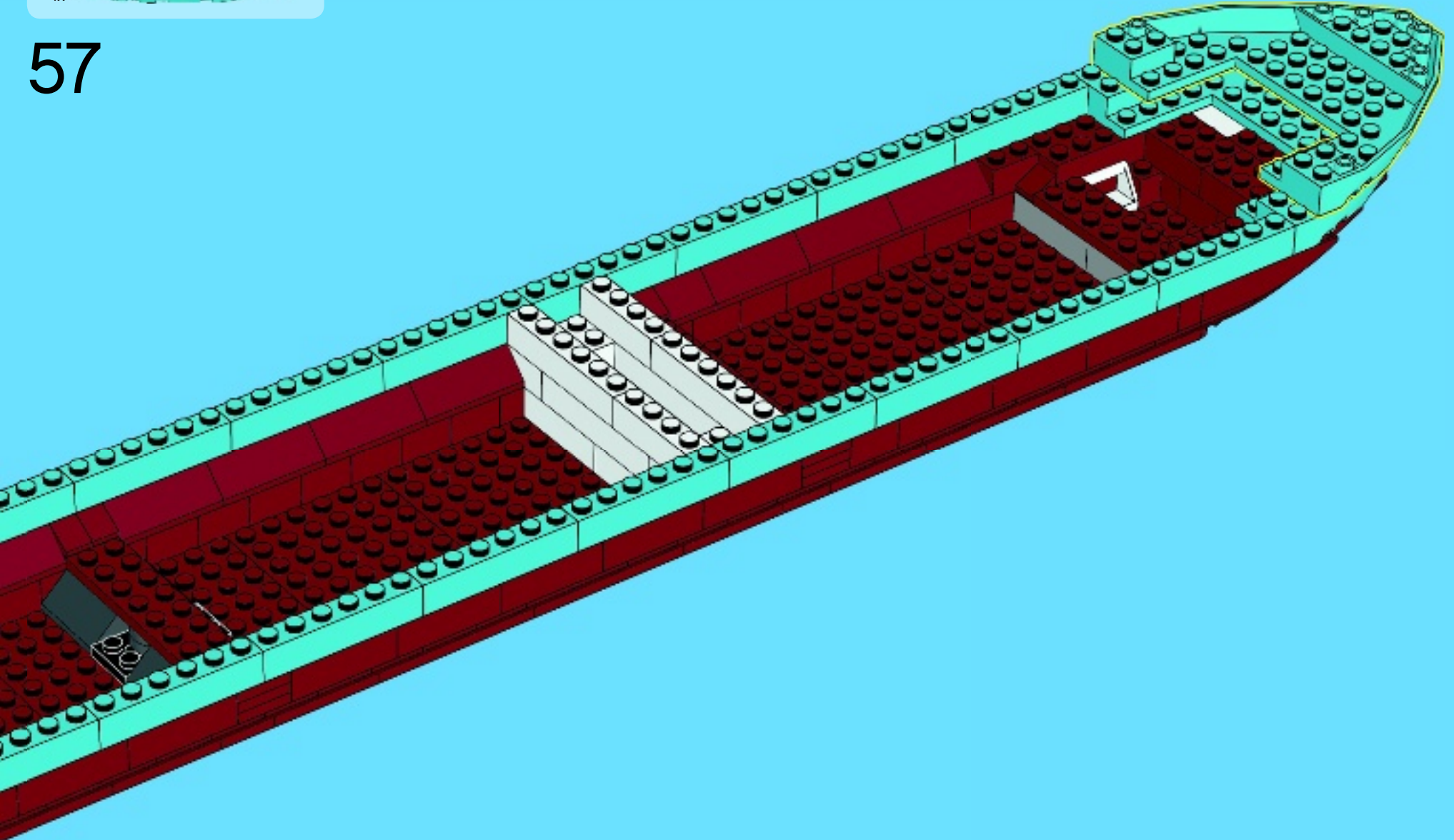

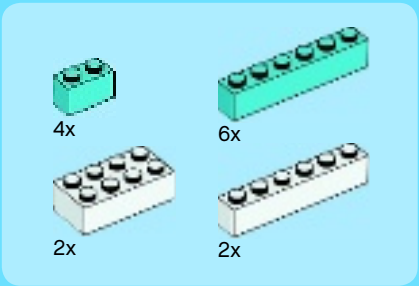

58

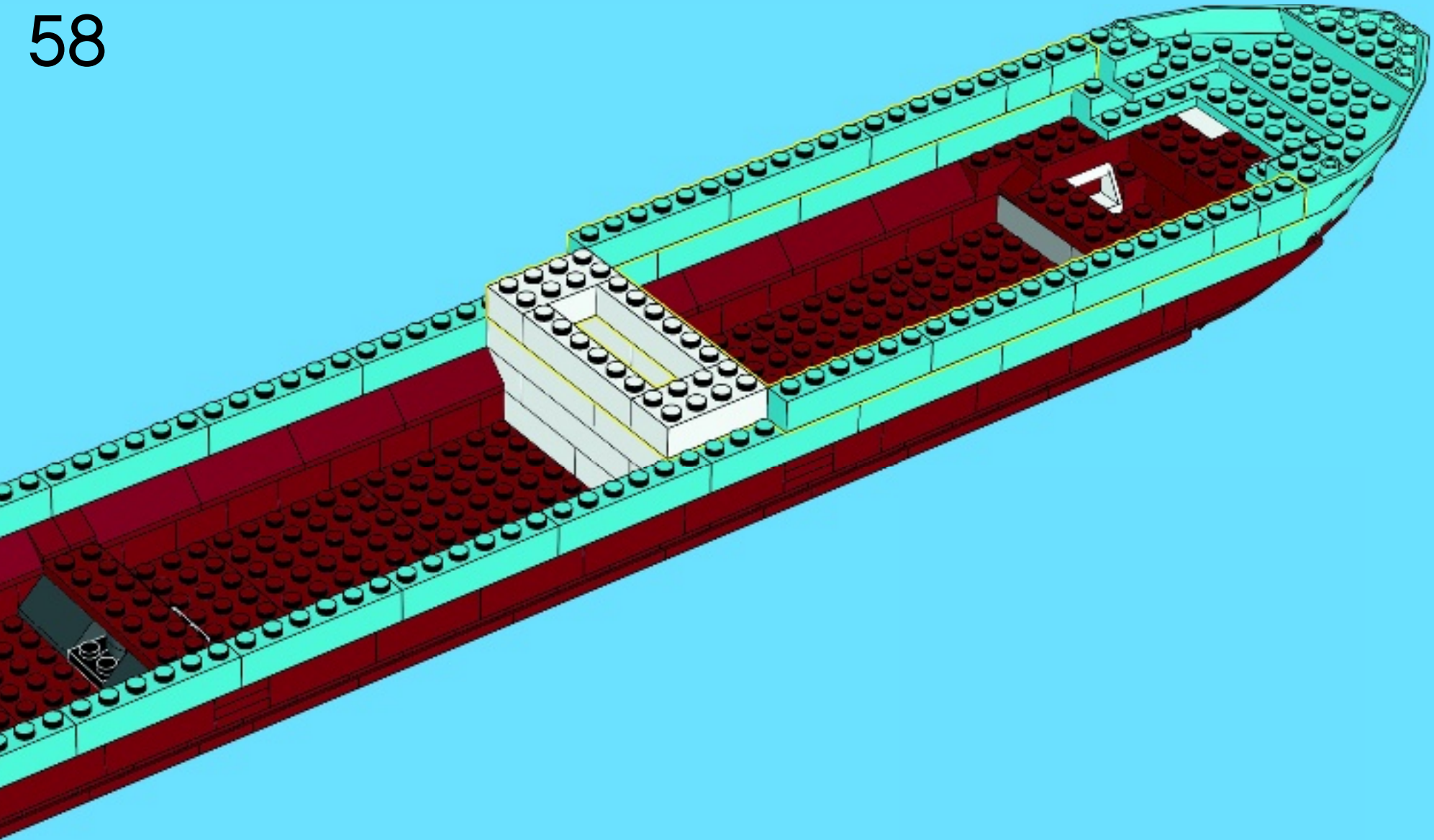

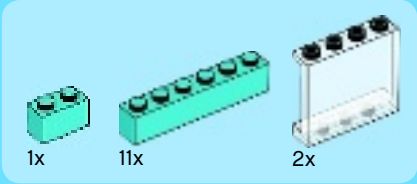

59

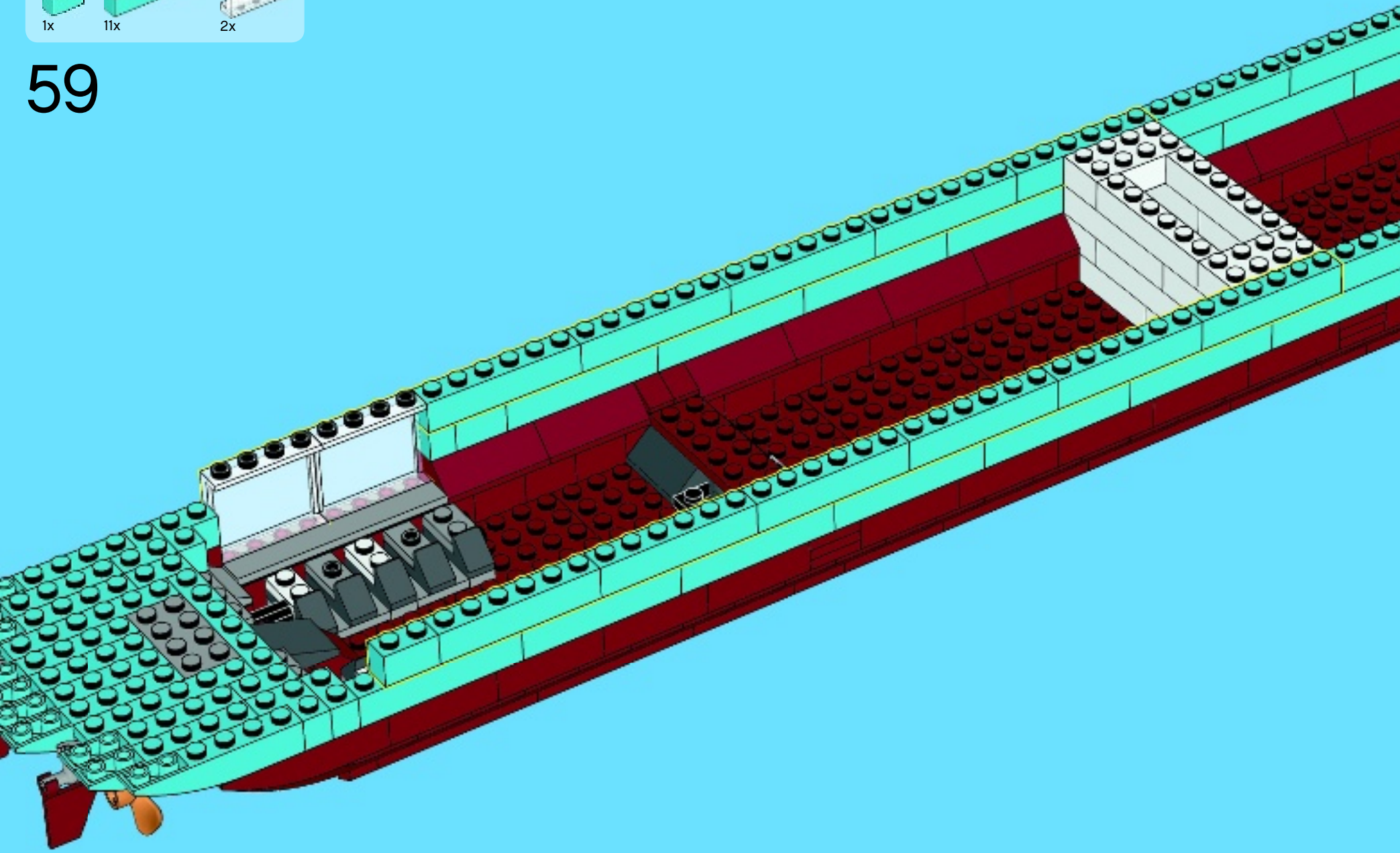

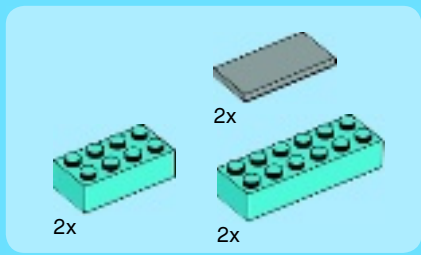

60

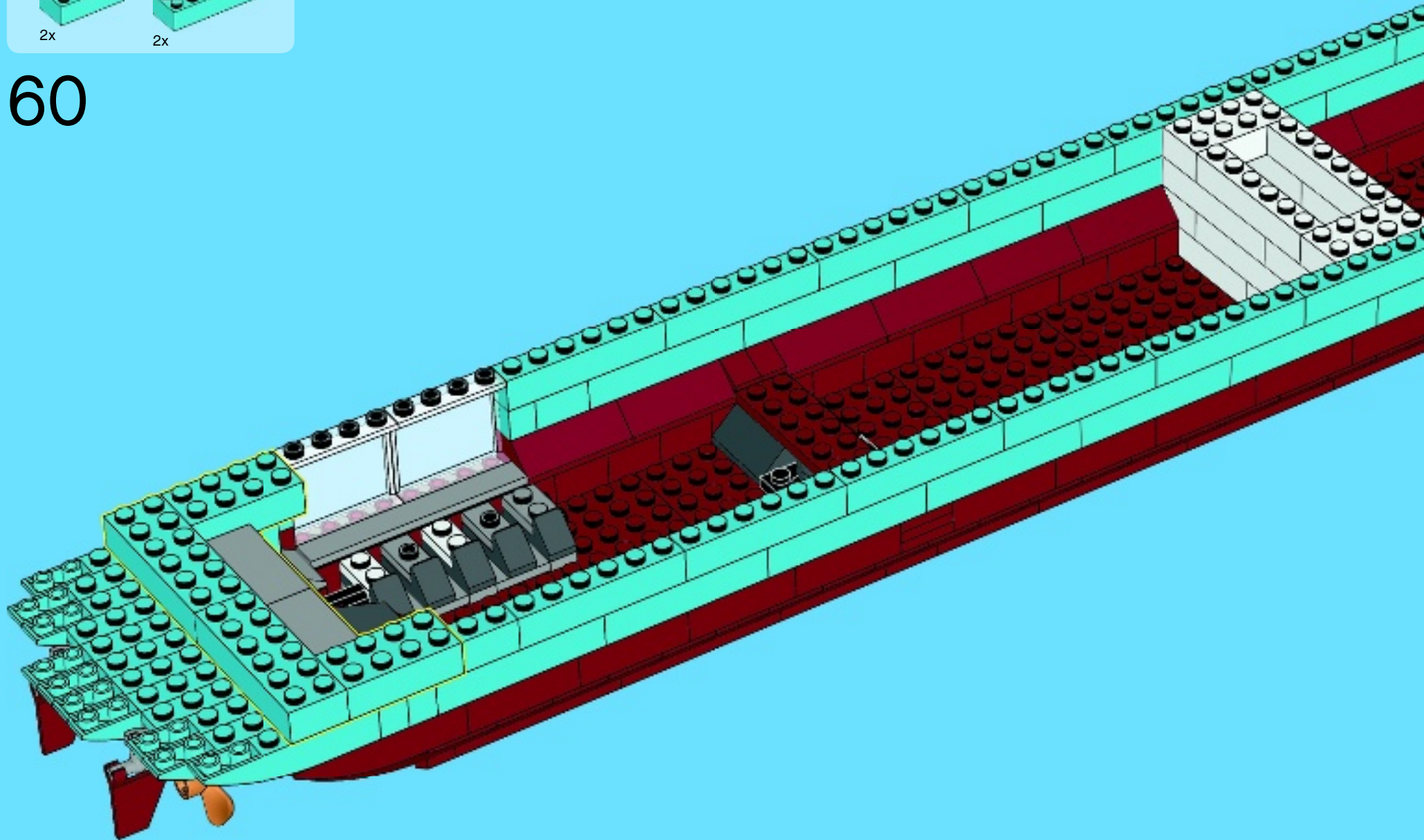

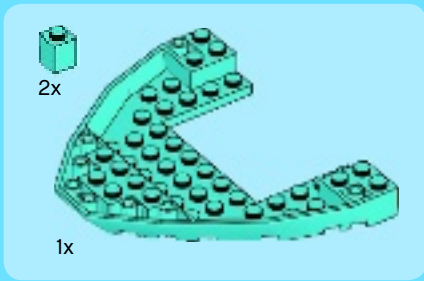

61

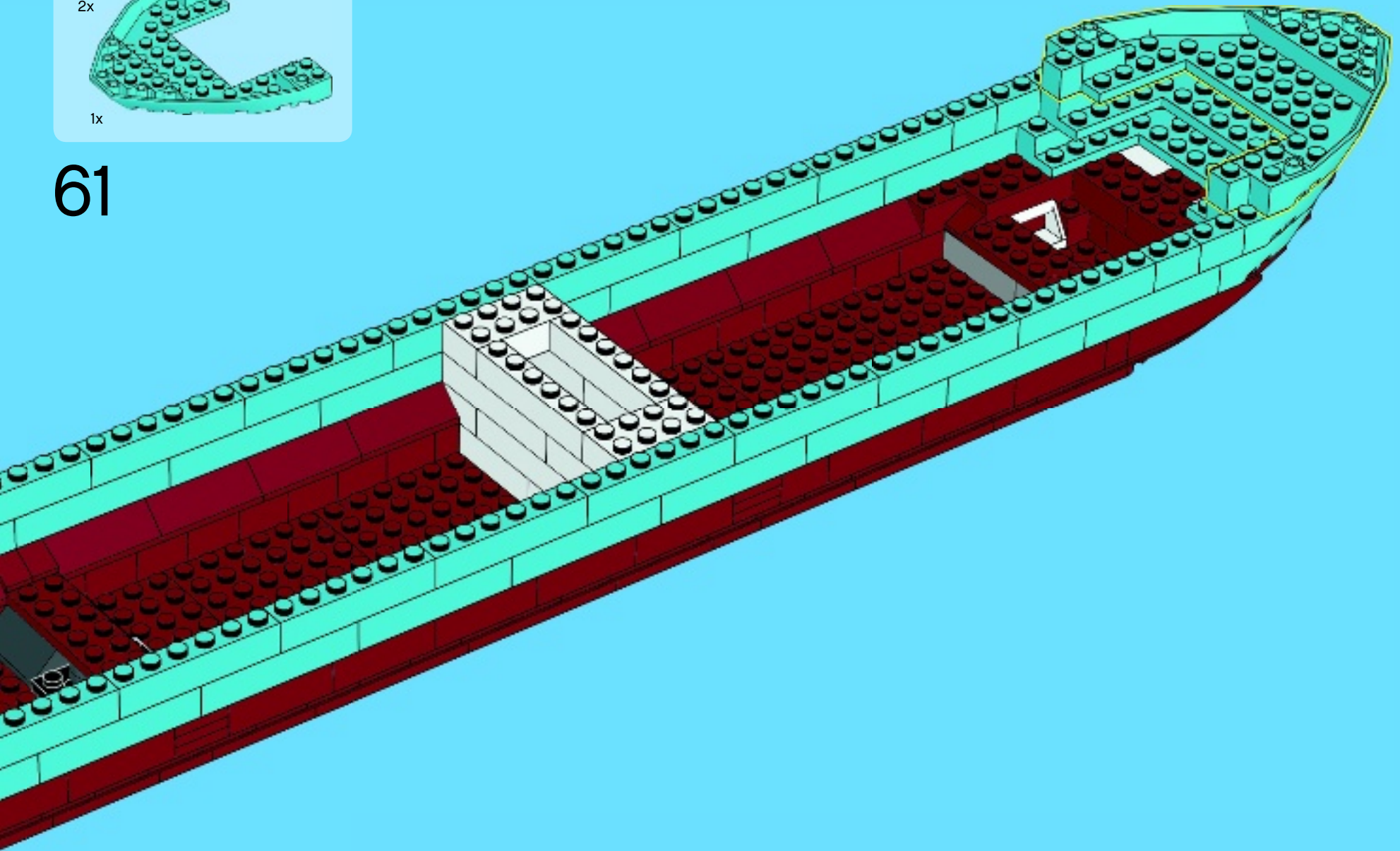



62

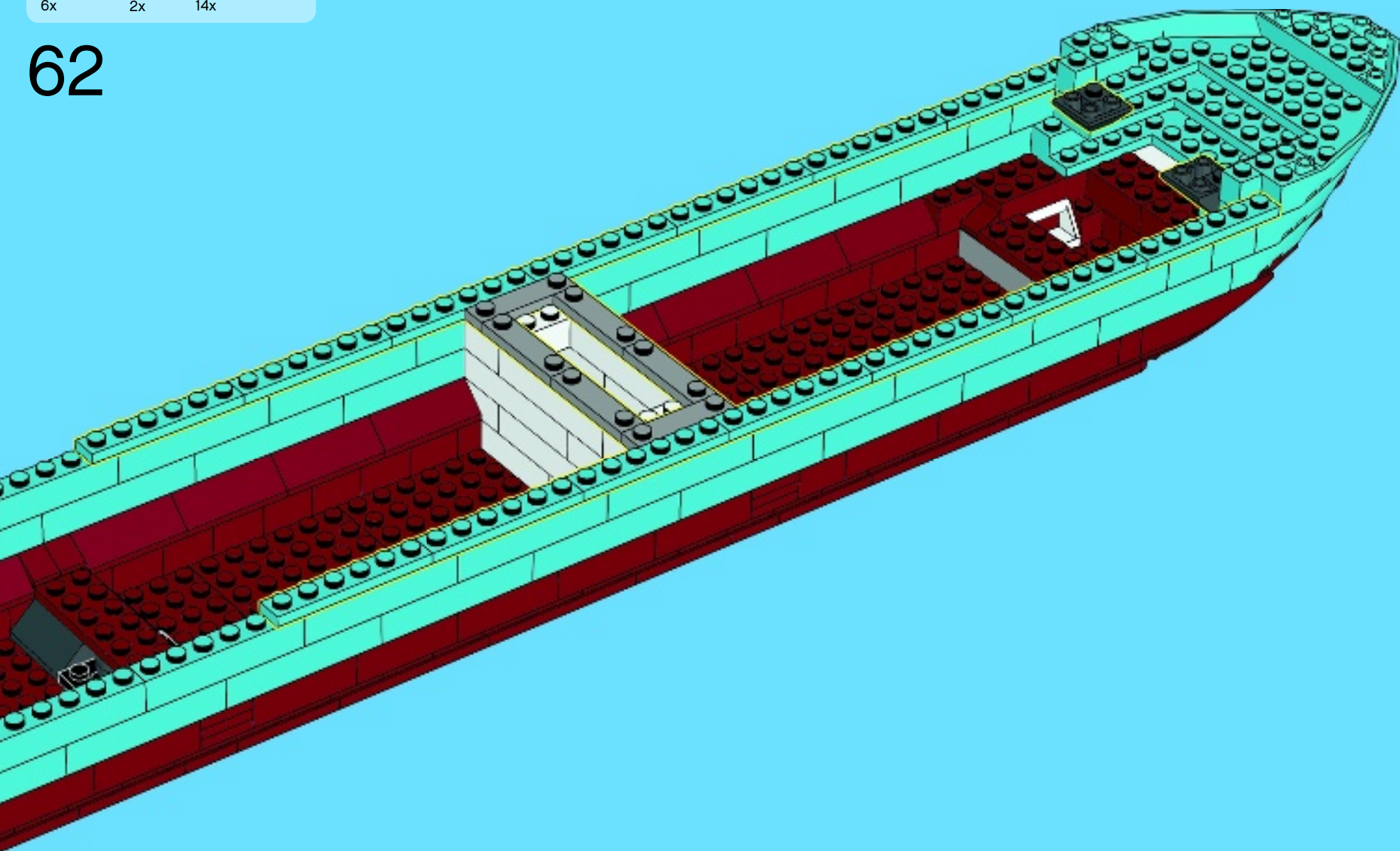



8x

63

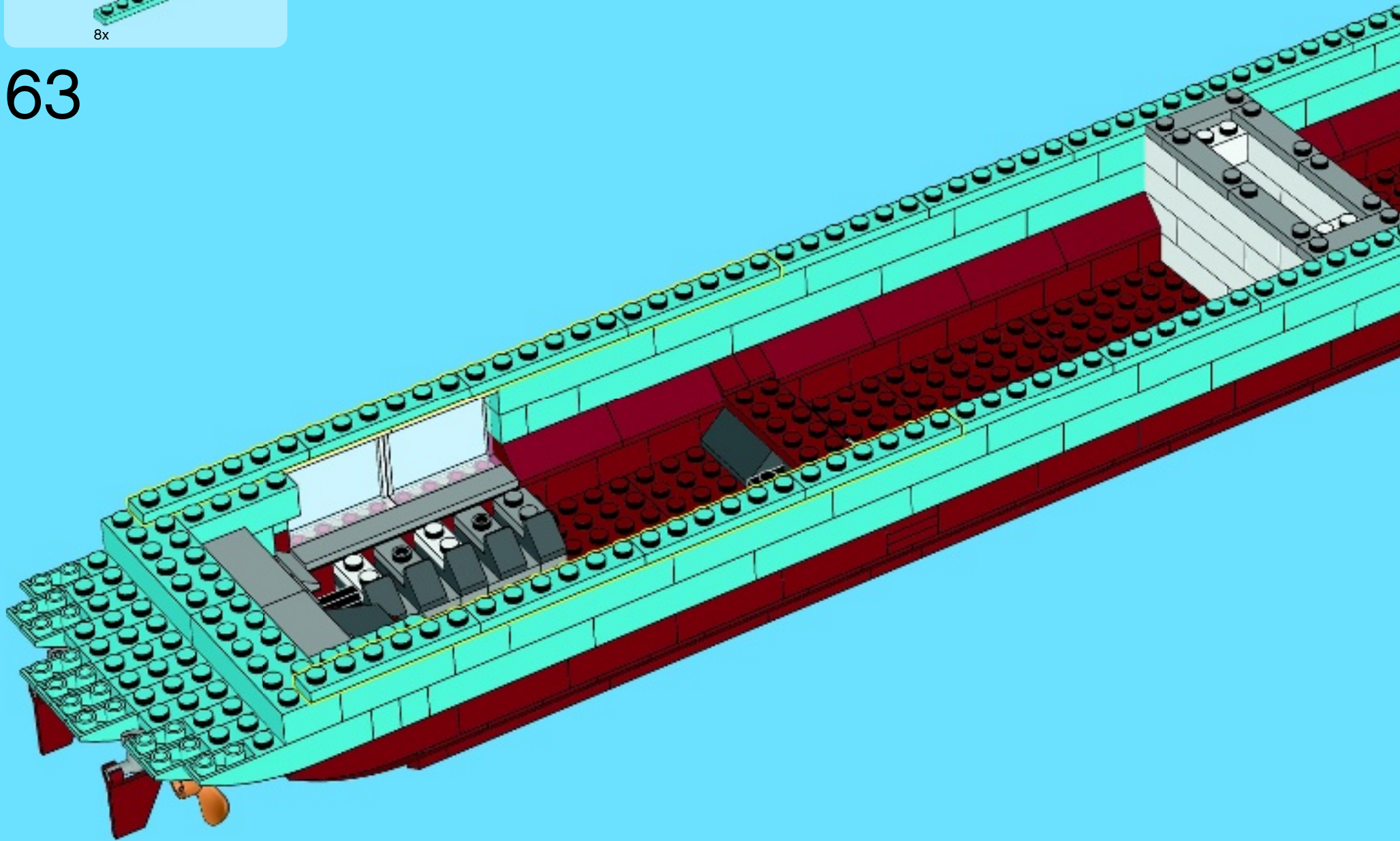



27x

64

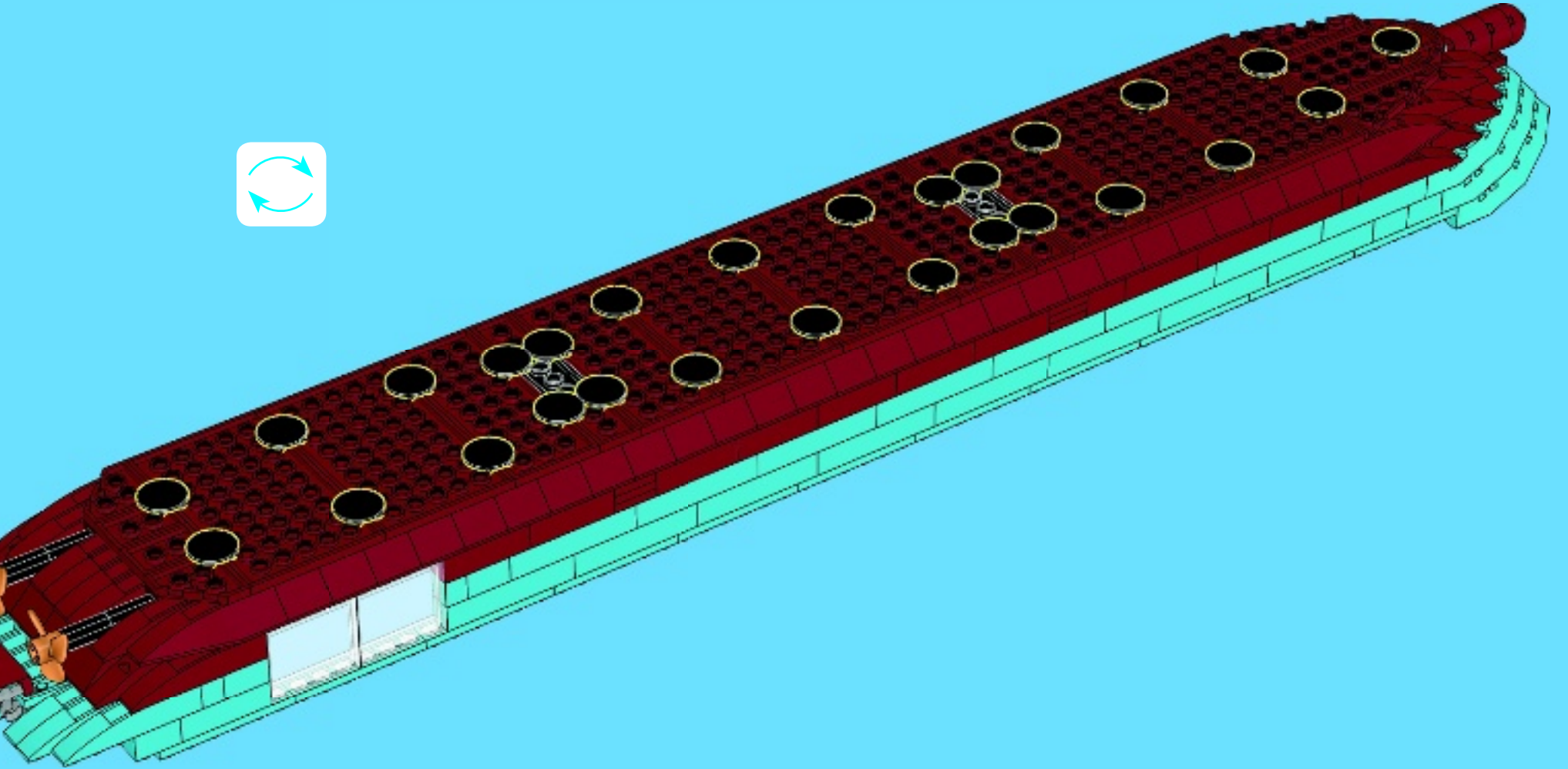

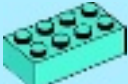
4x  3x 

65

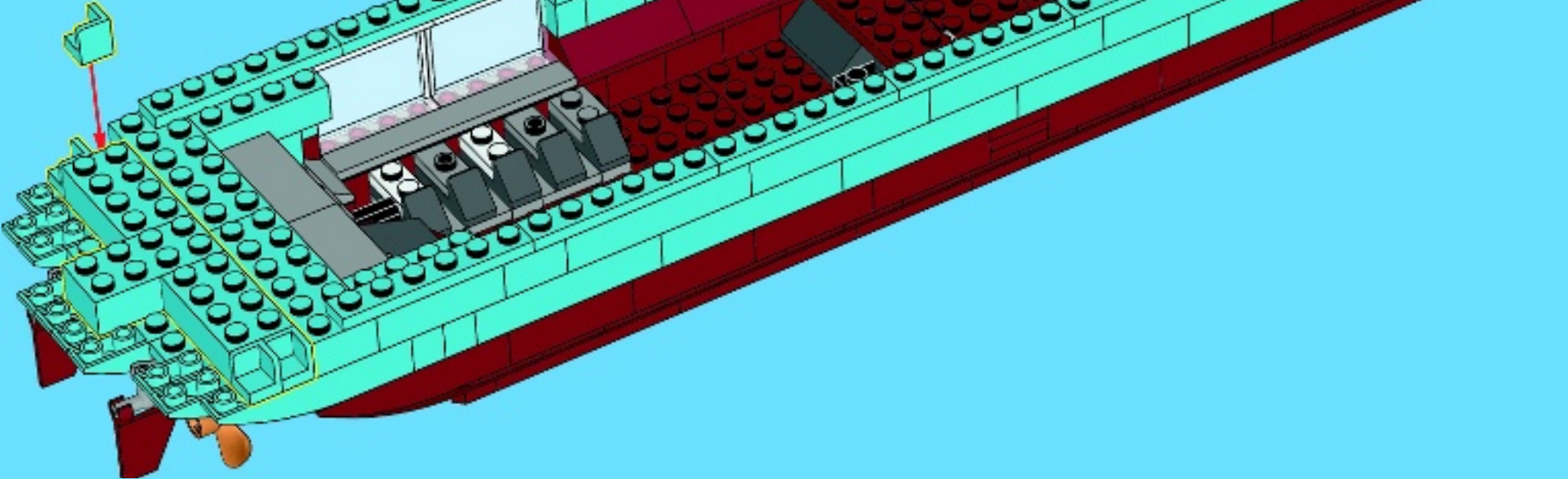

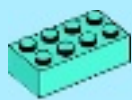

2x



2x



2x

66

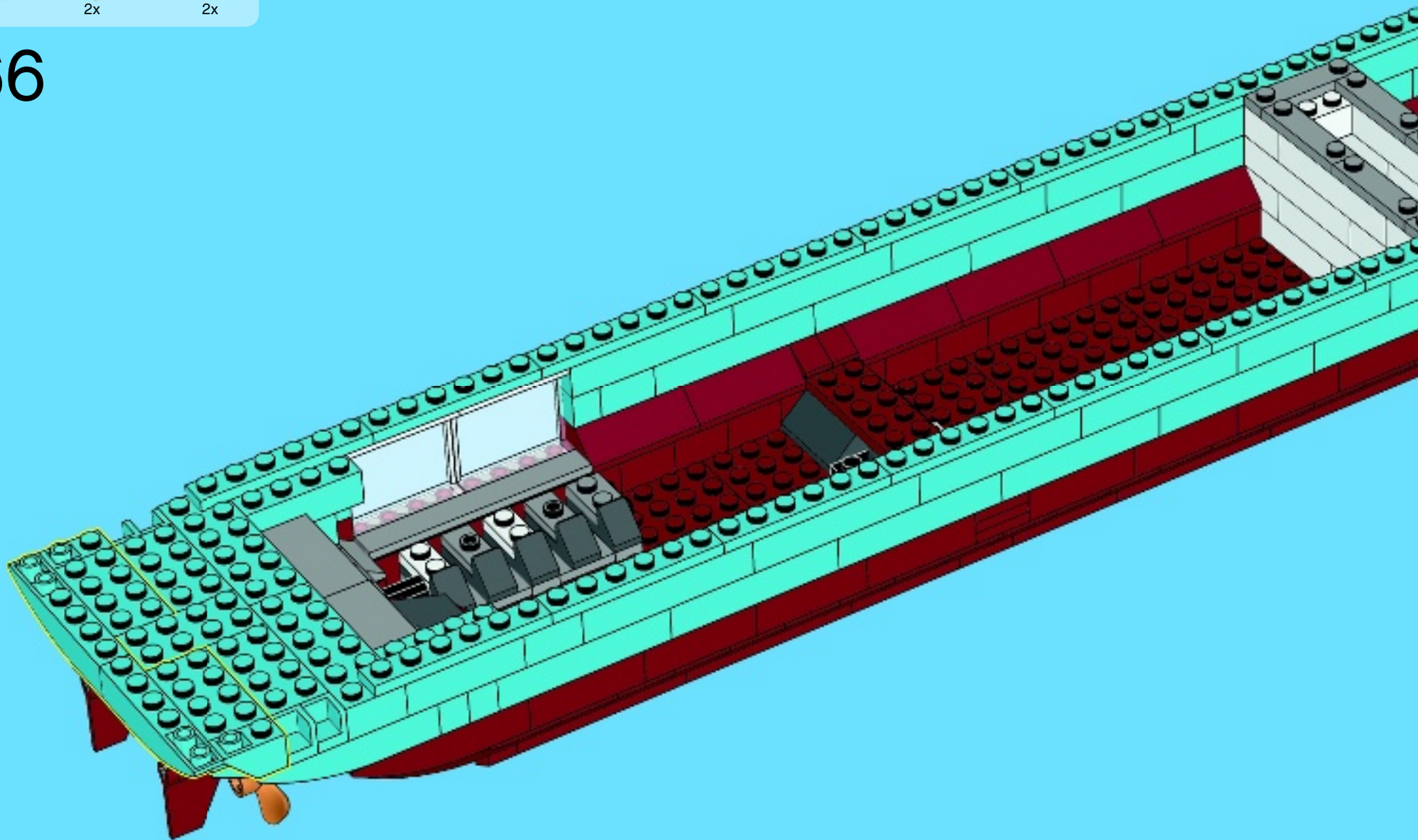

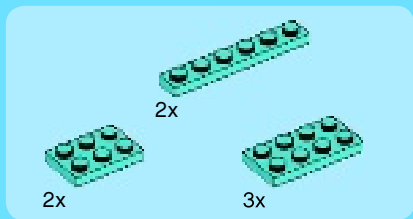

67

NE FORG MO FIKSET HOLLER
RETTET

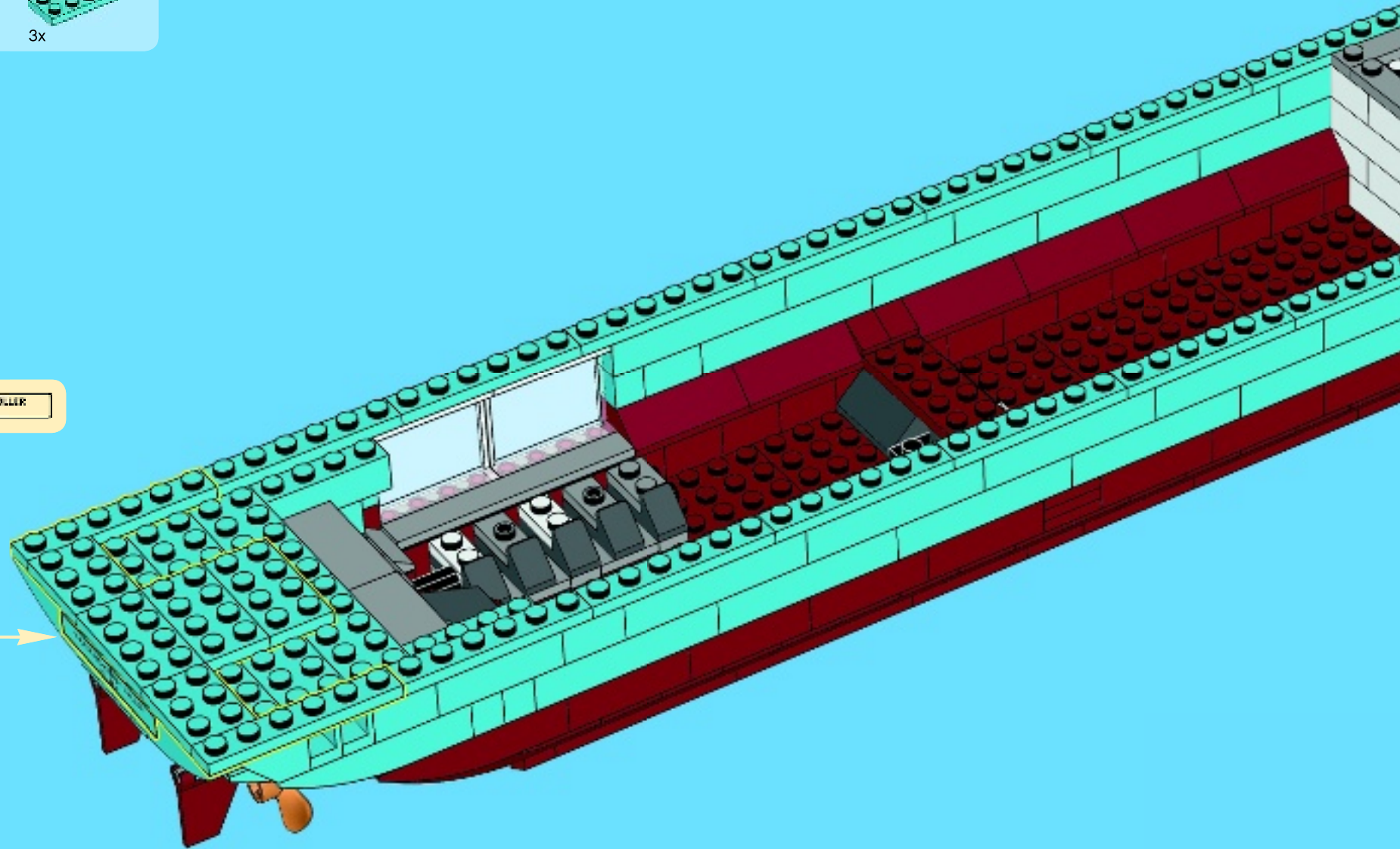

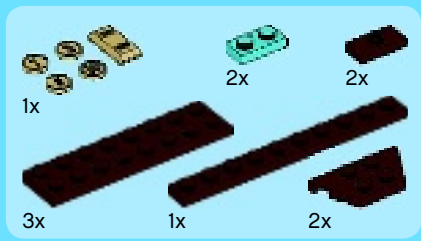

68

MAERSK LINE

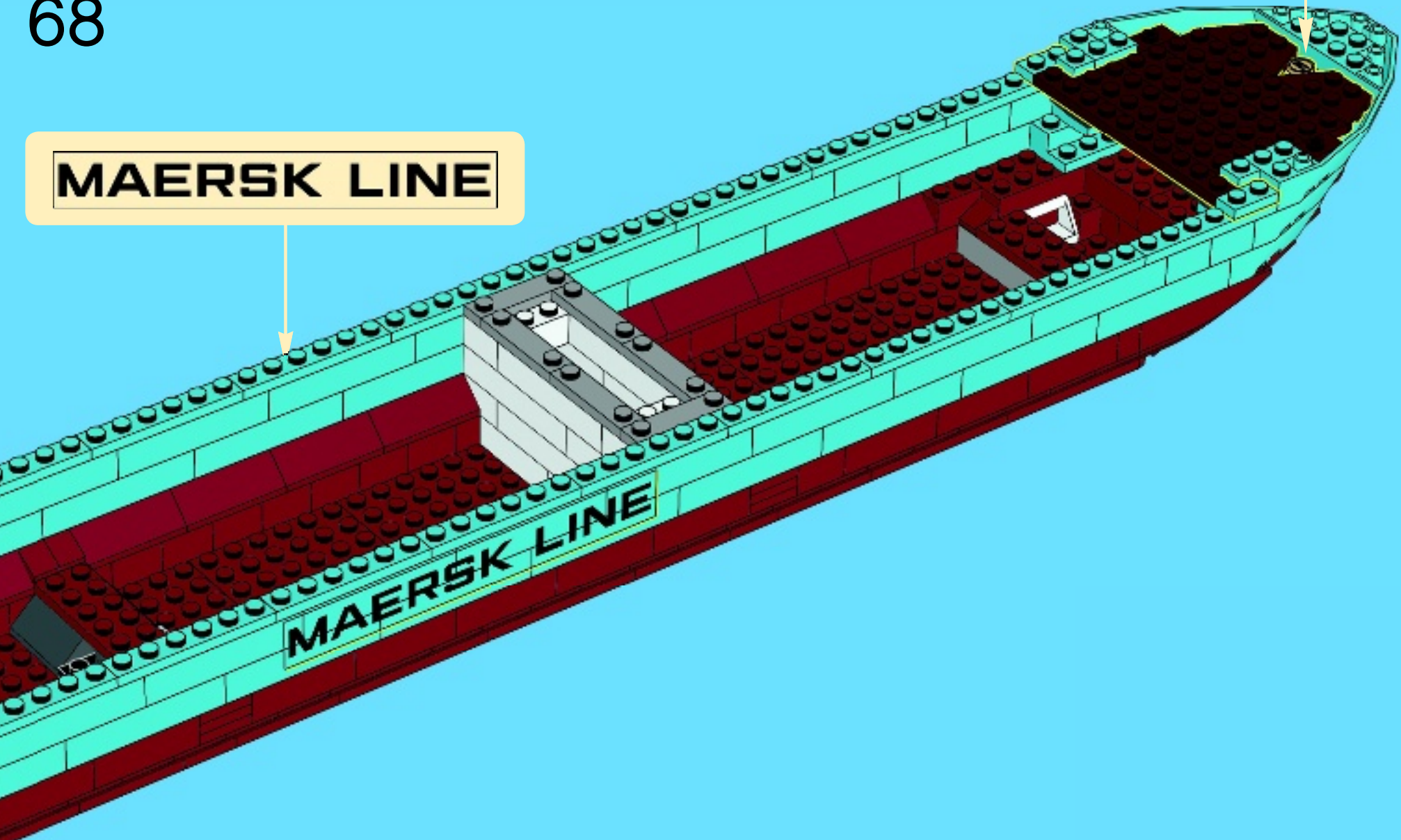

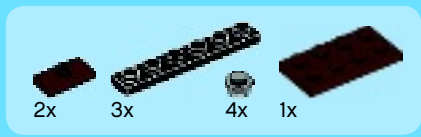

69

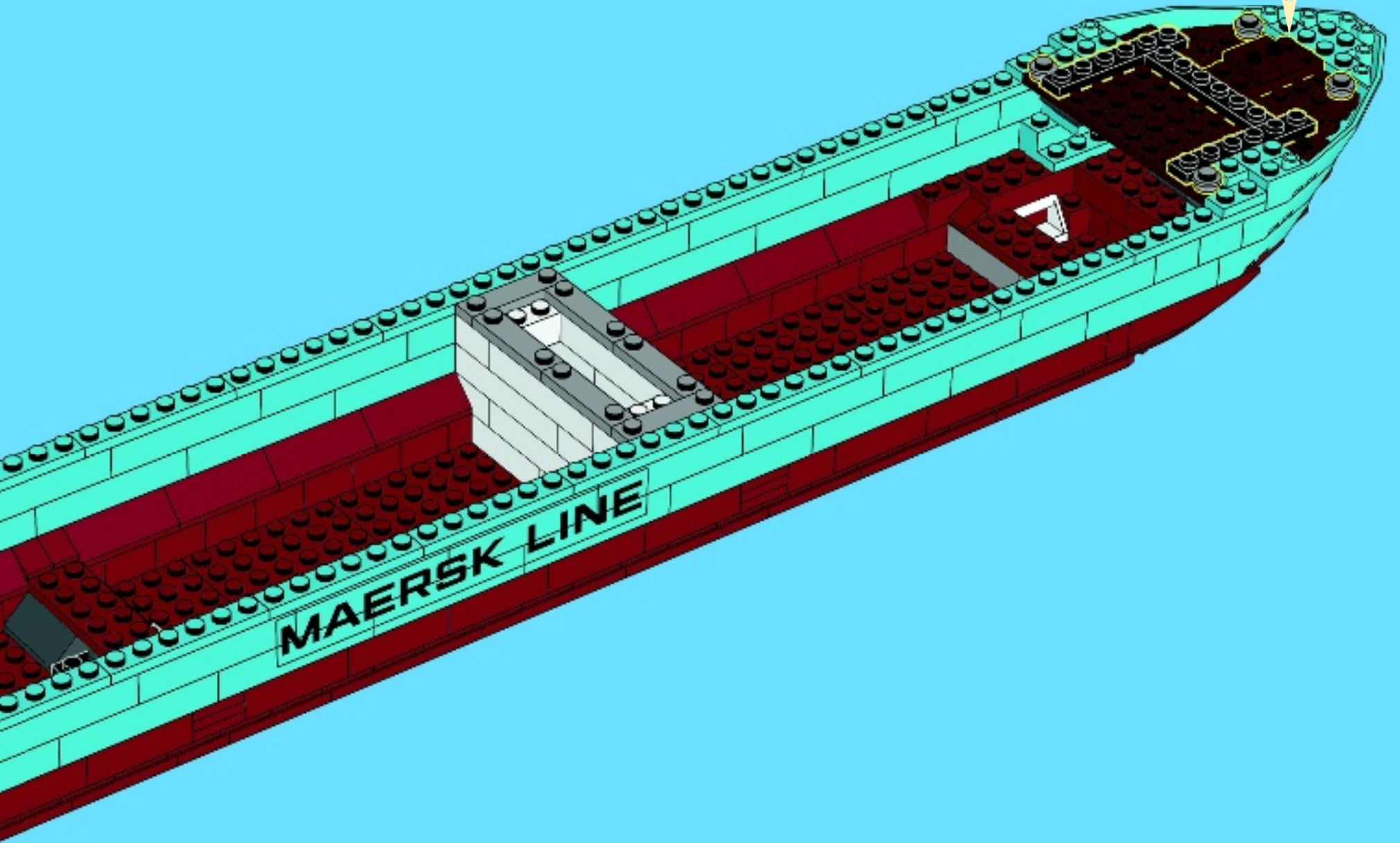
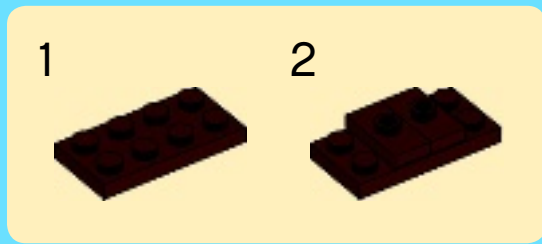

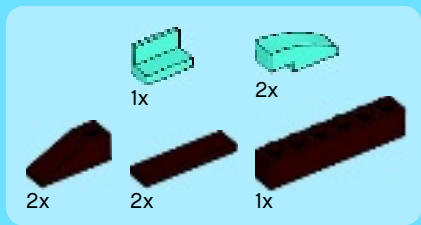

70

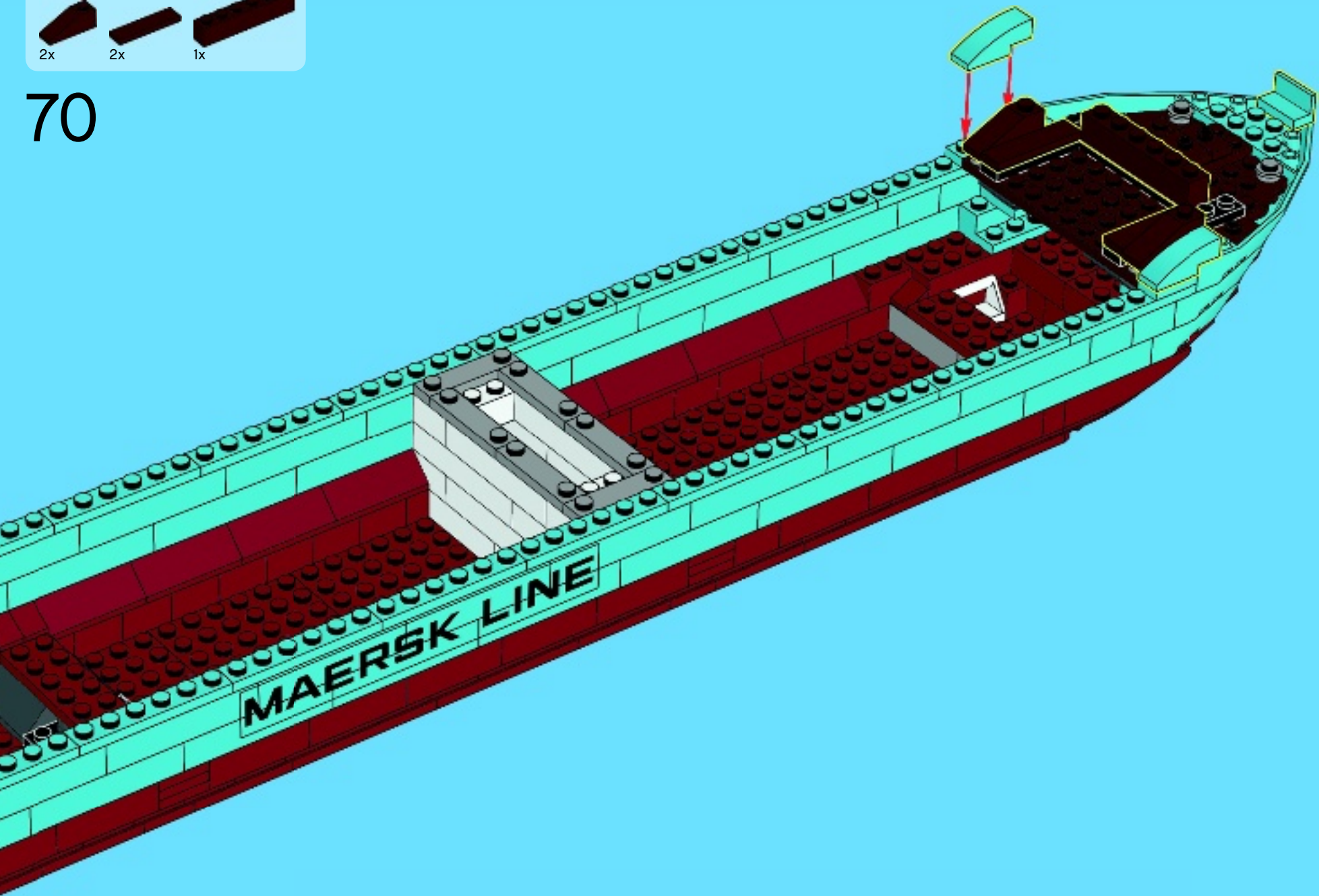

- 6x
- 2x
- 2x
- 2x

71

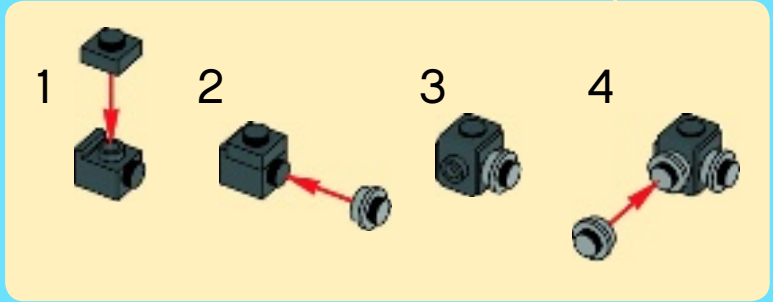
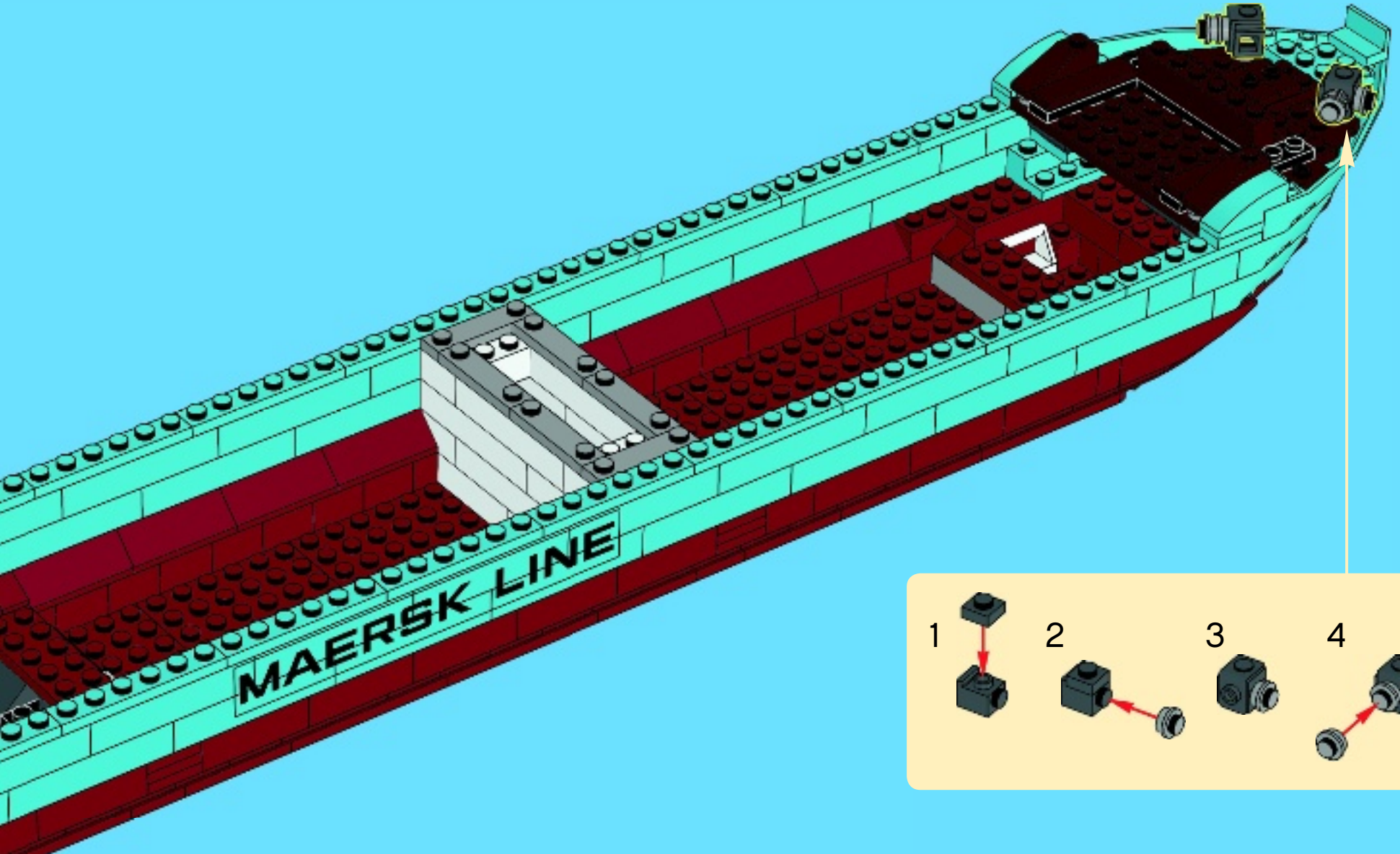
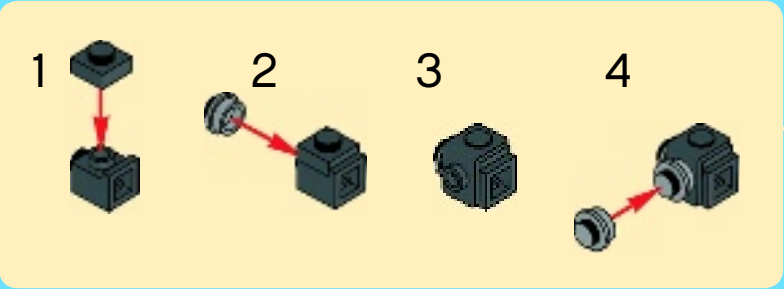

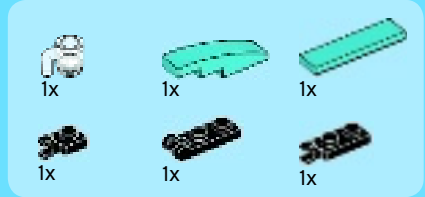

72

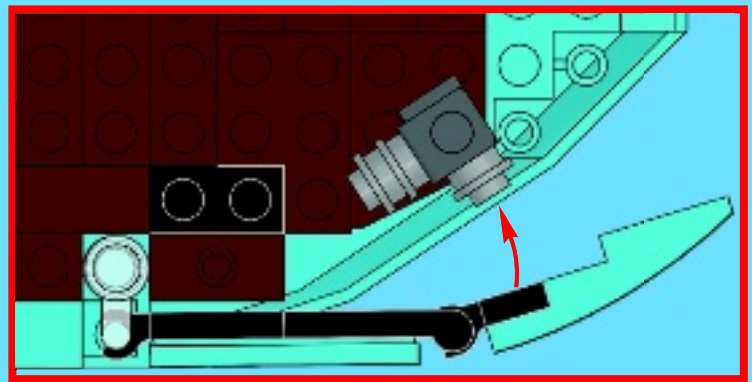
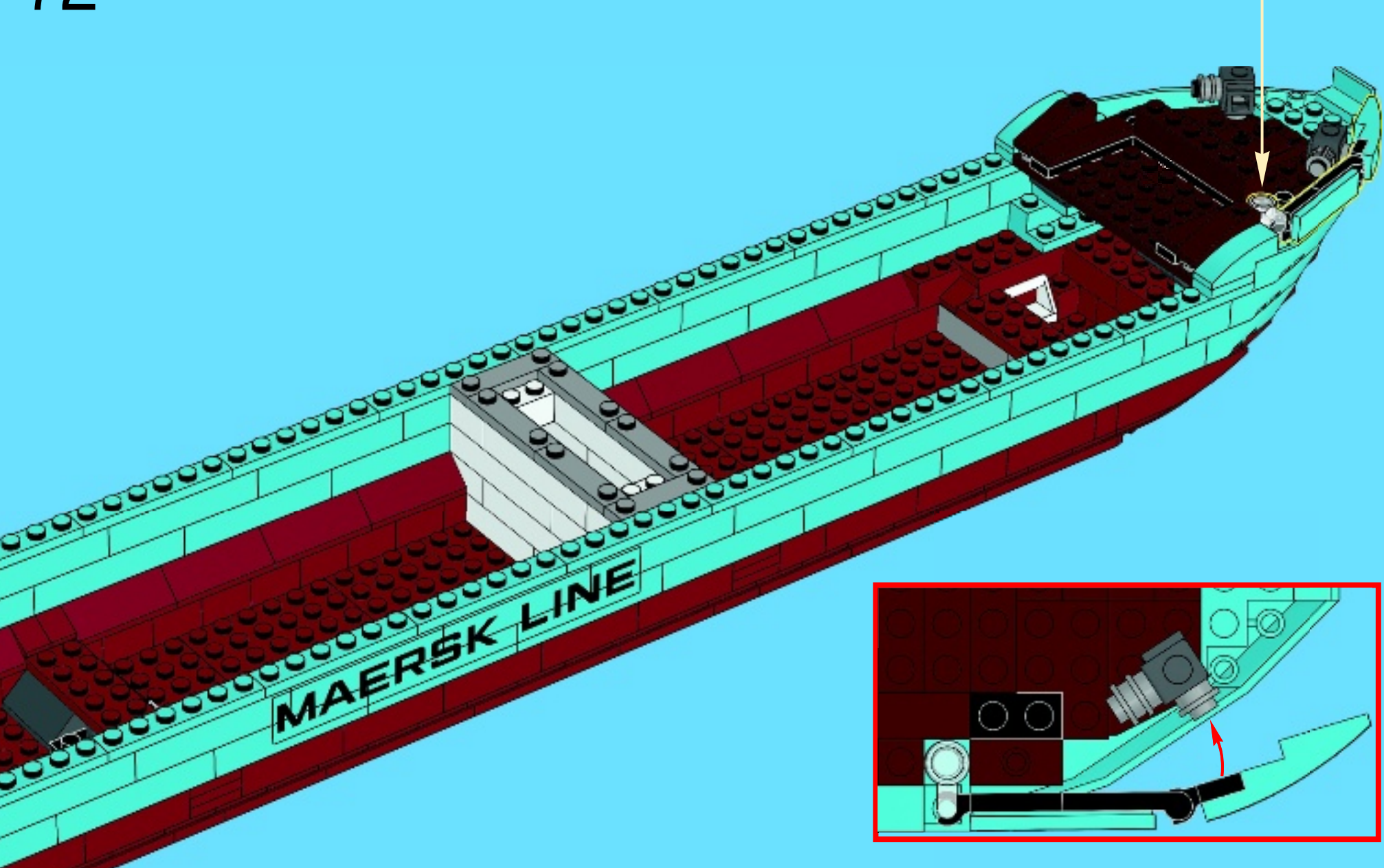
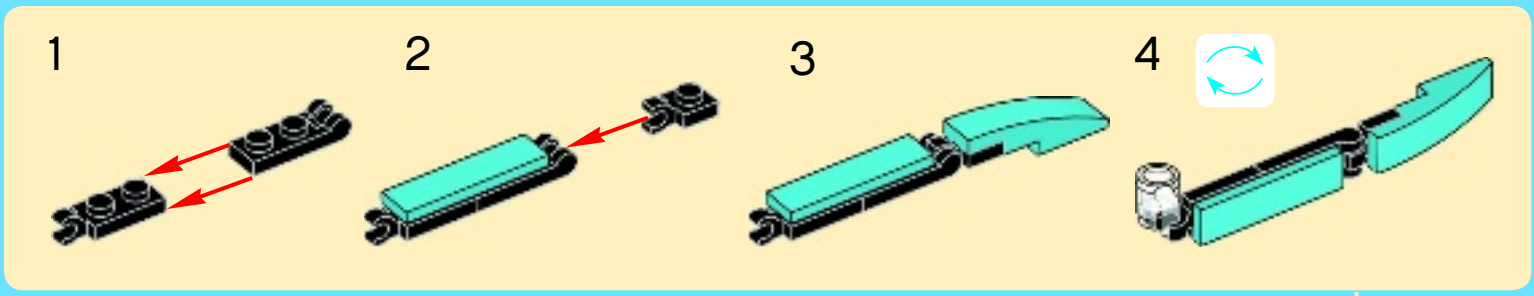

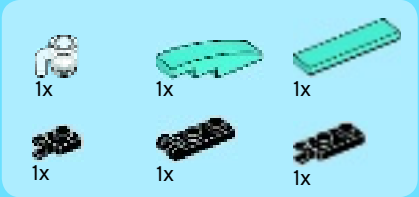

73

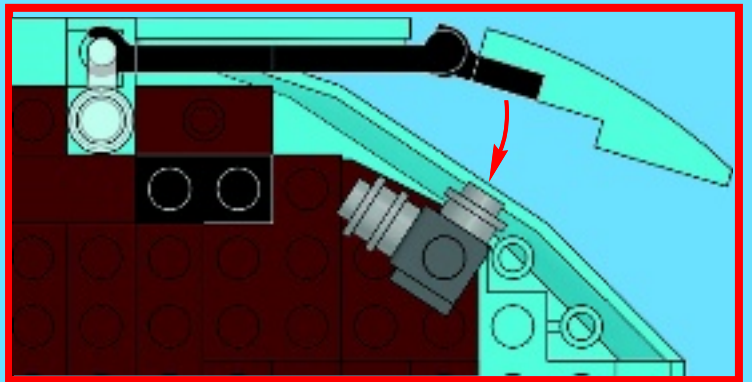
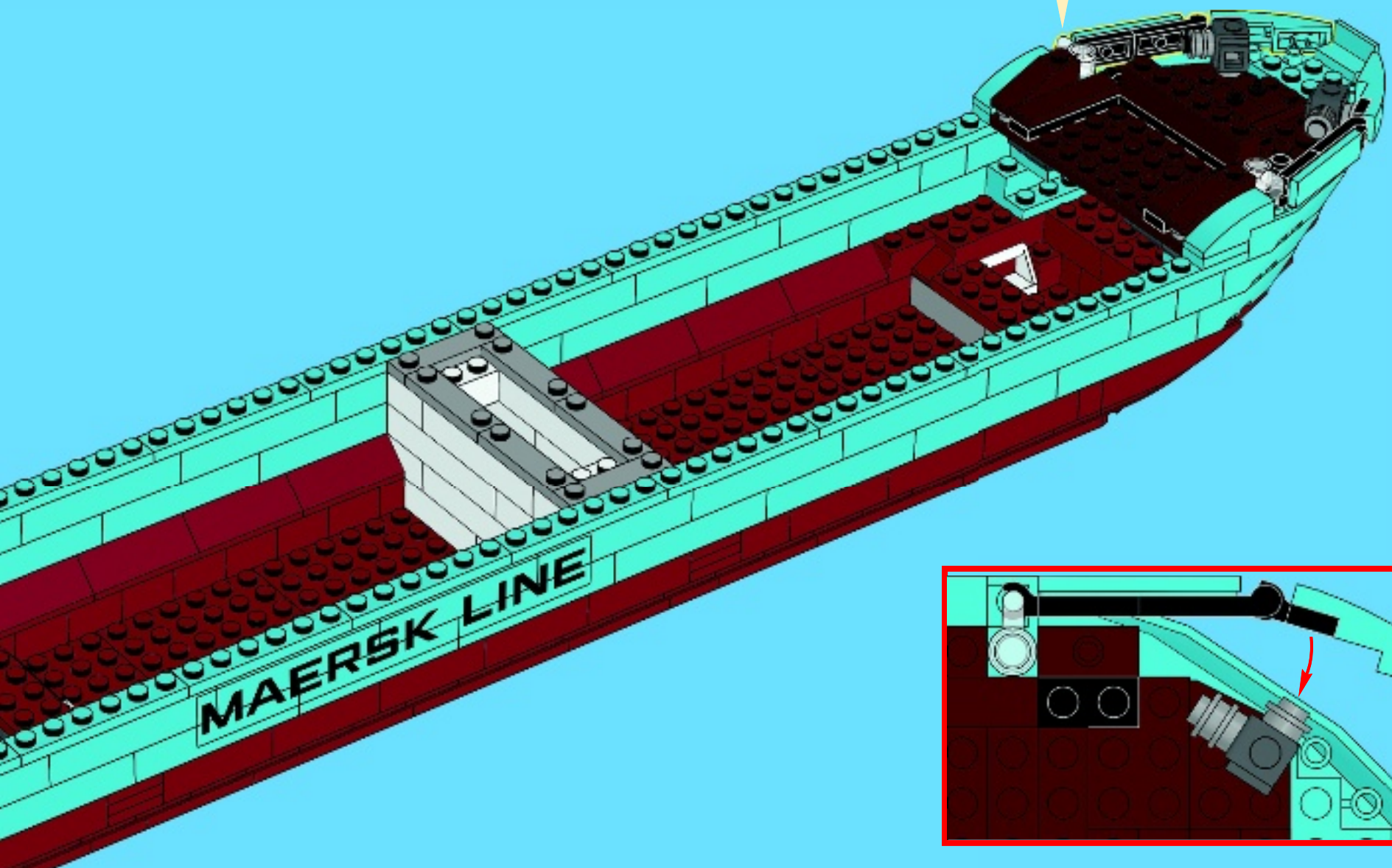
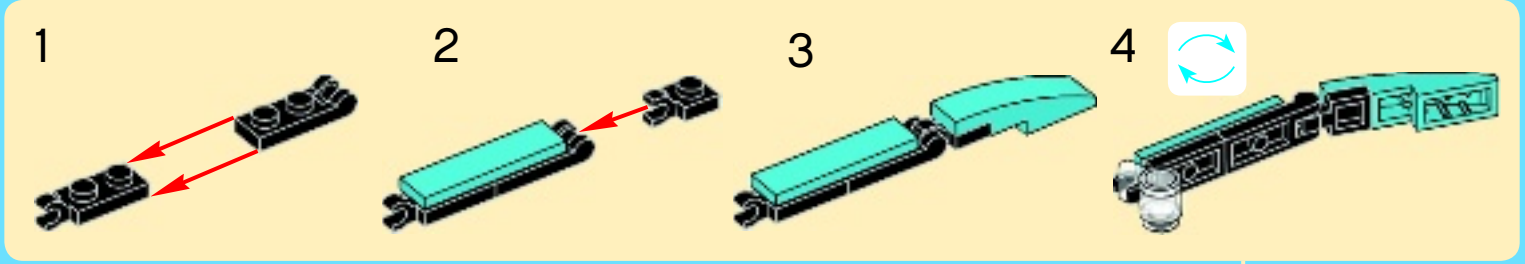



2x



2x



1x

74

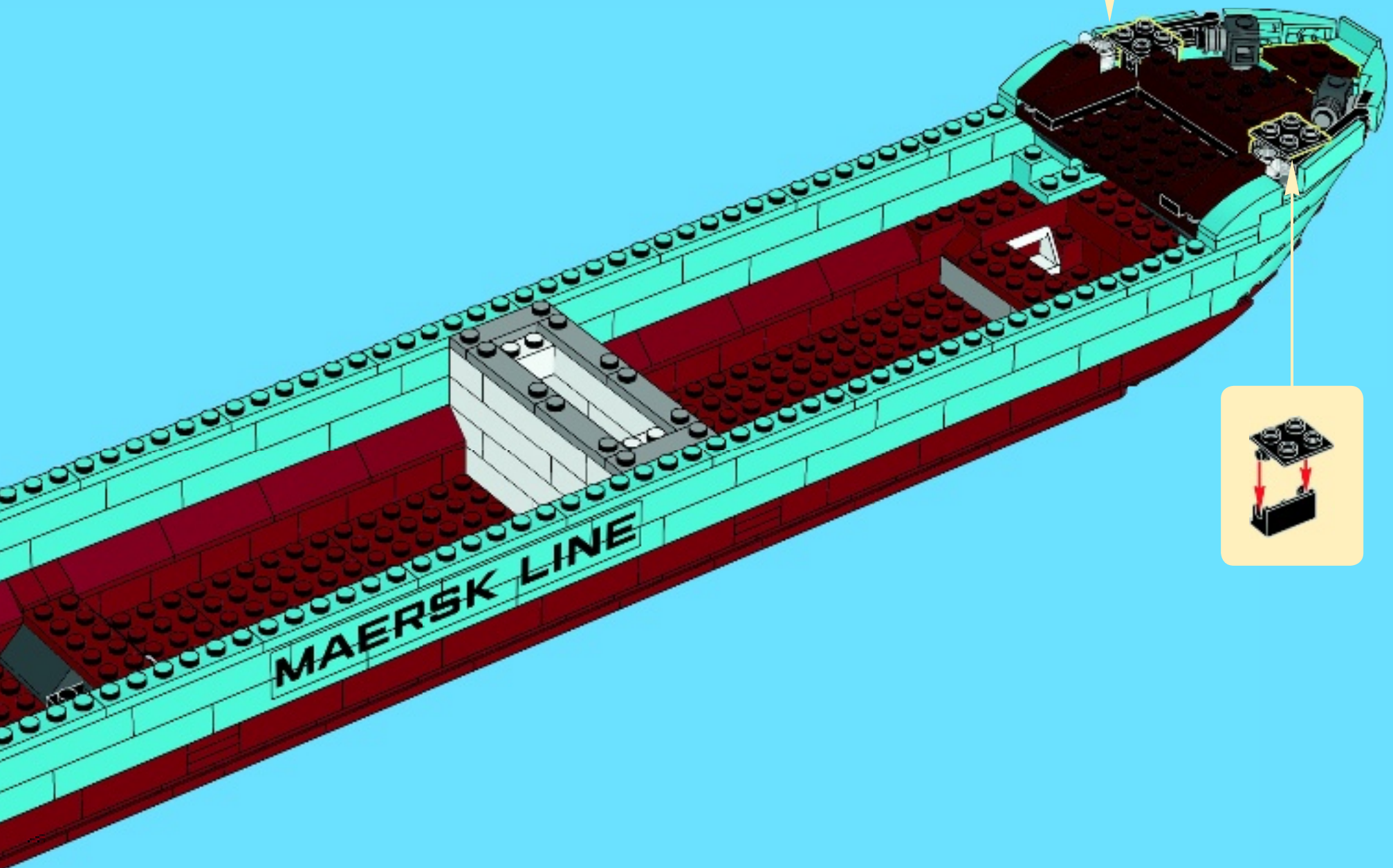
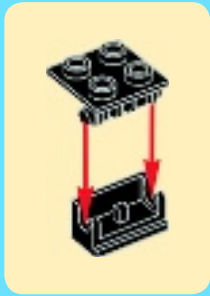

MAERSK LINE

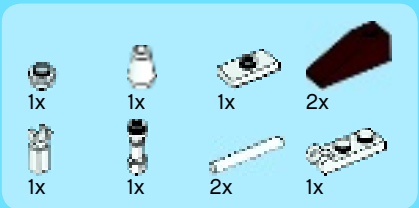

75

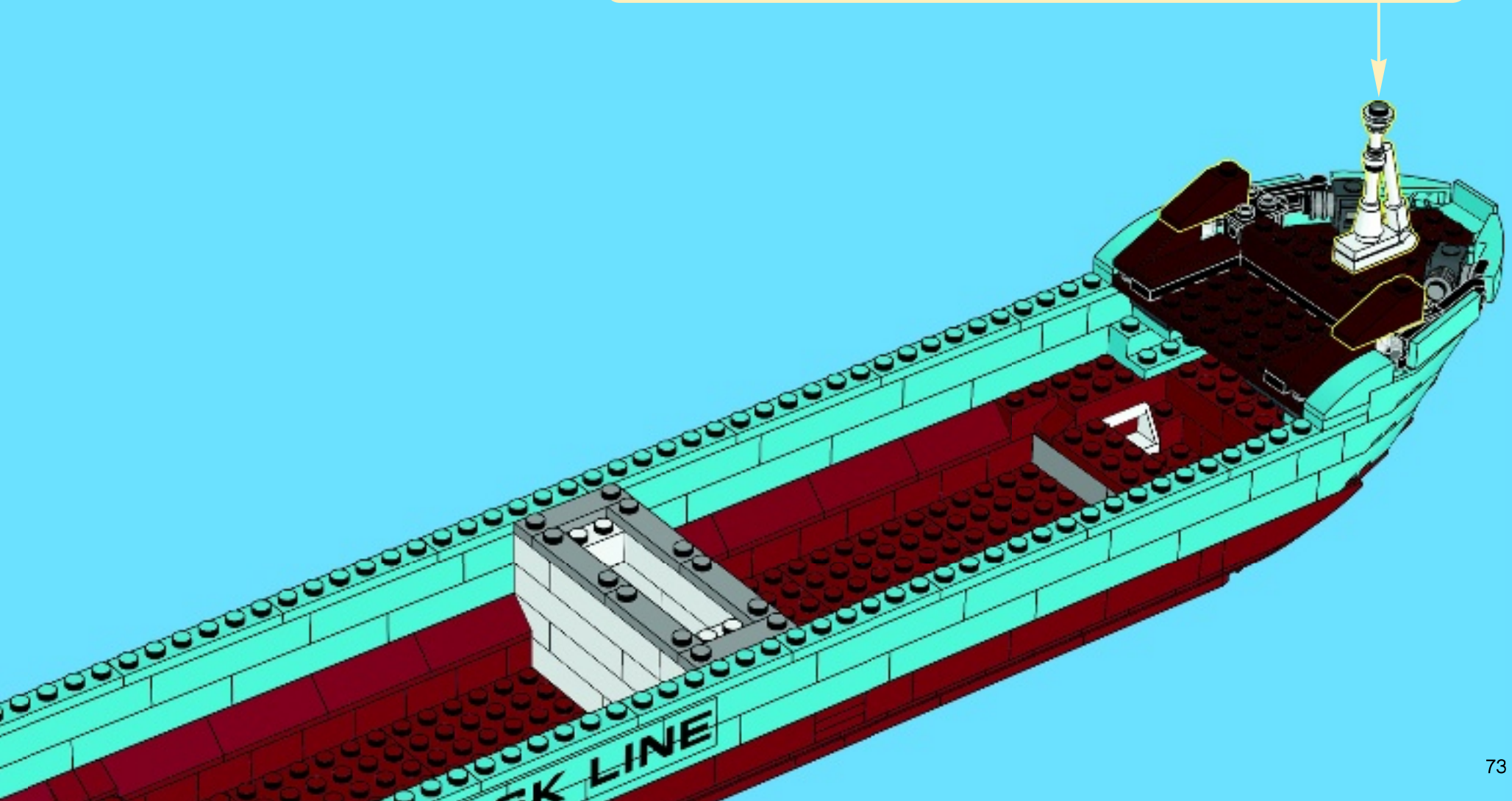
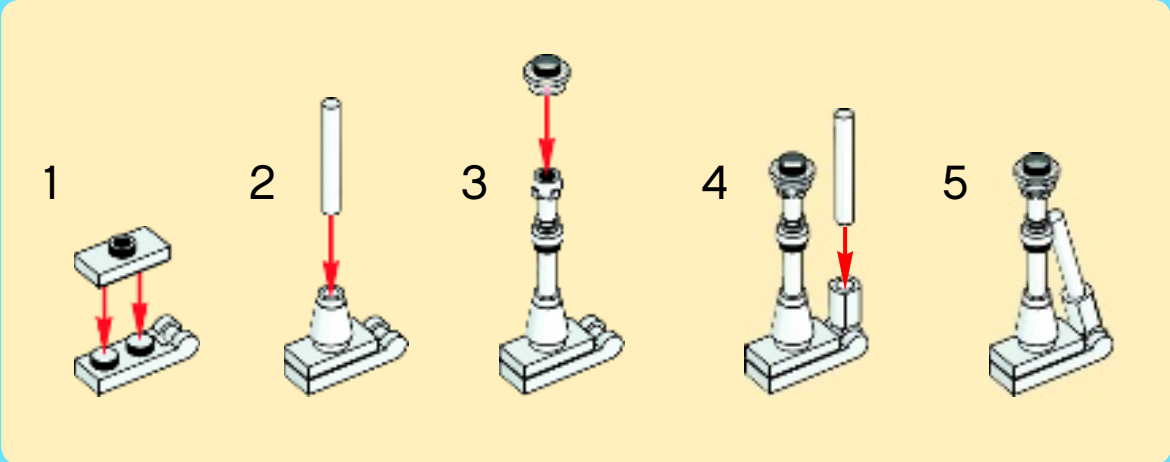

1x

1x

2x

76

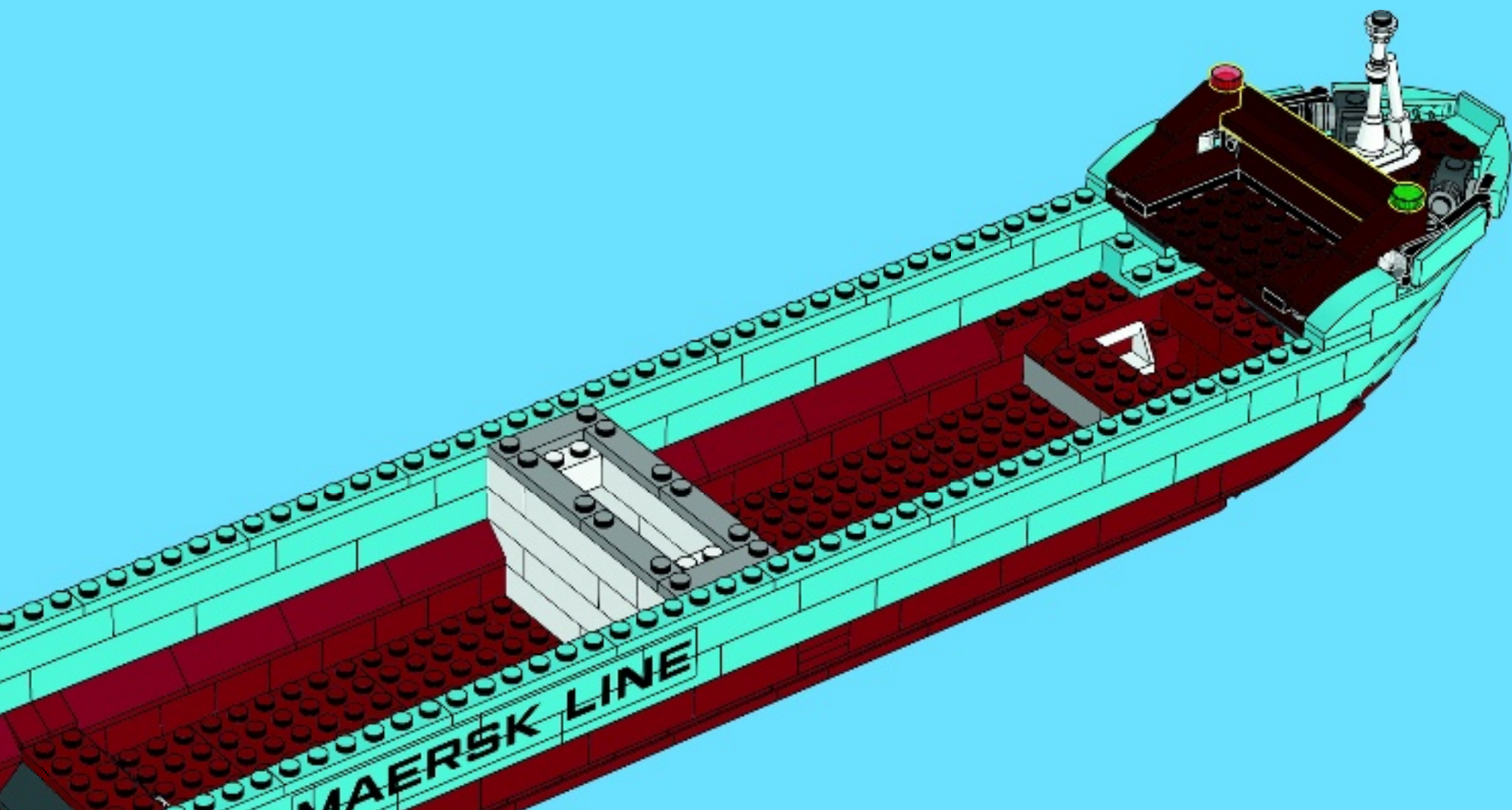

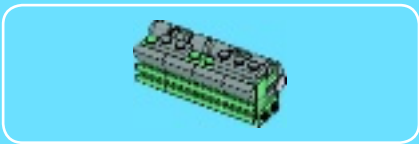

1

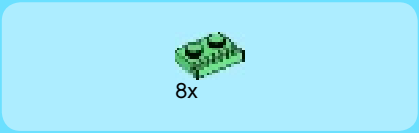
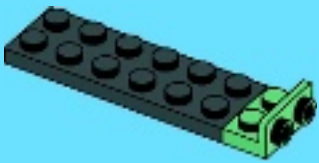

2

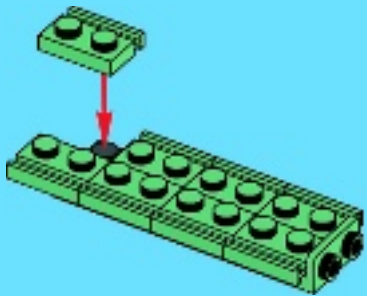

3

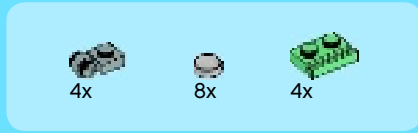
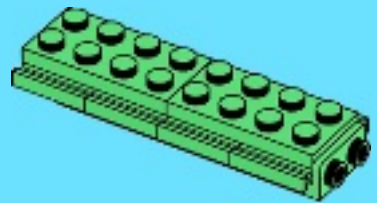

4

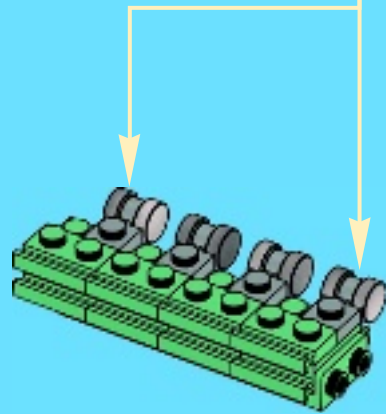
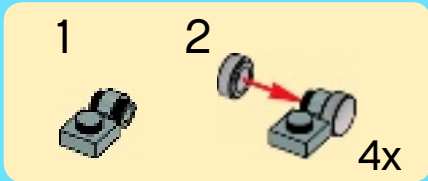

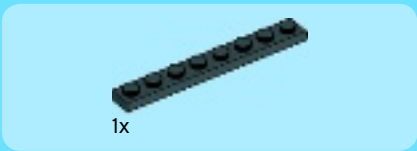

5

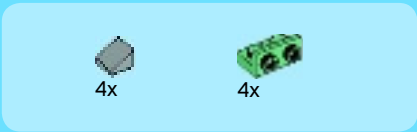
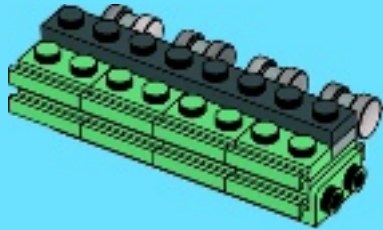

6

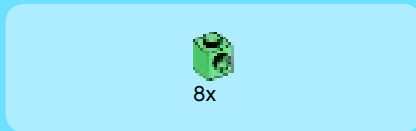
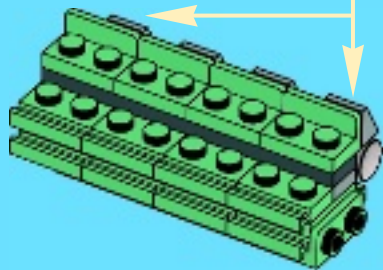
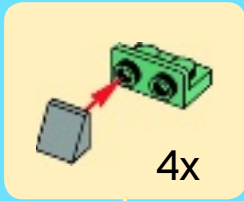

7

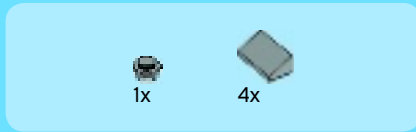
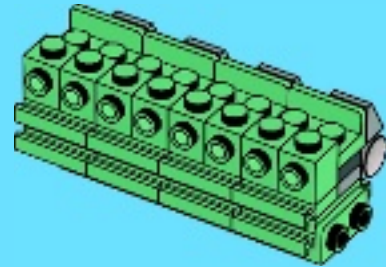

8

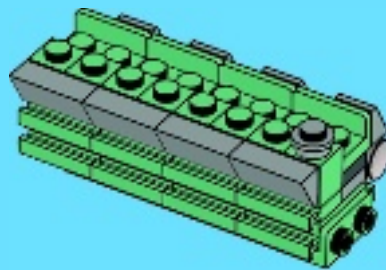



4x



2x

9

1



2



2x

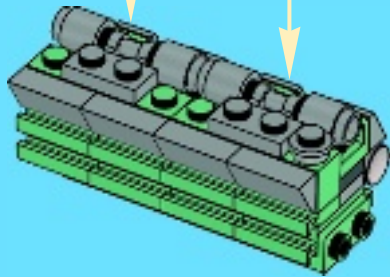

1x

10

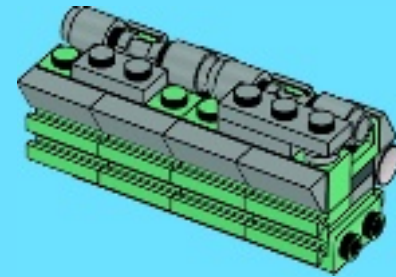

77

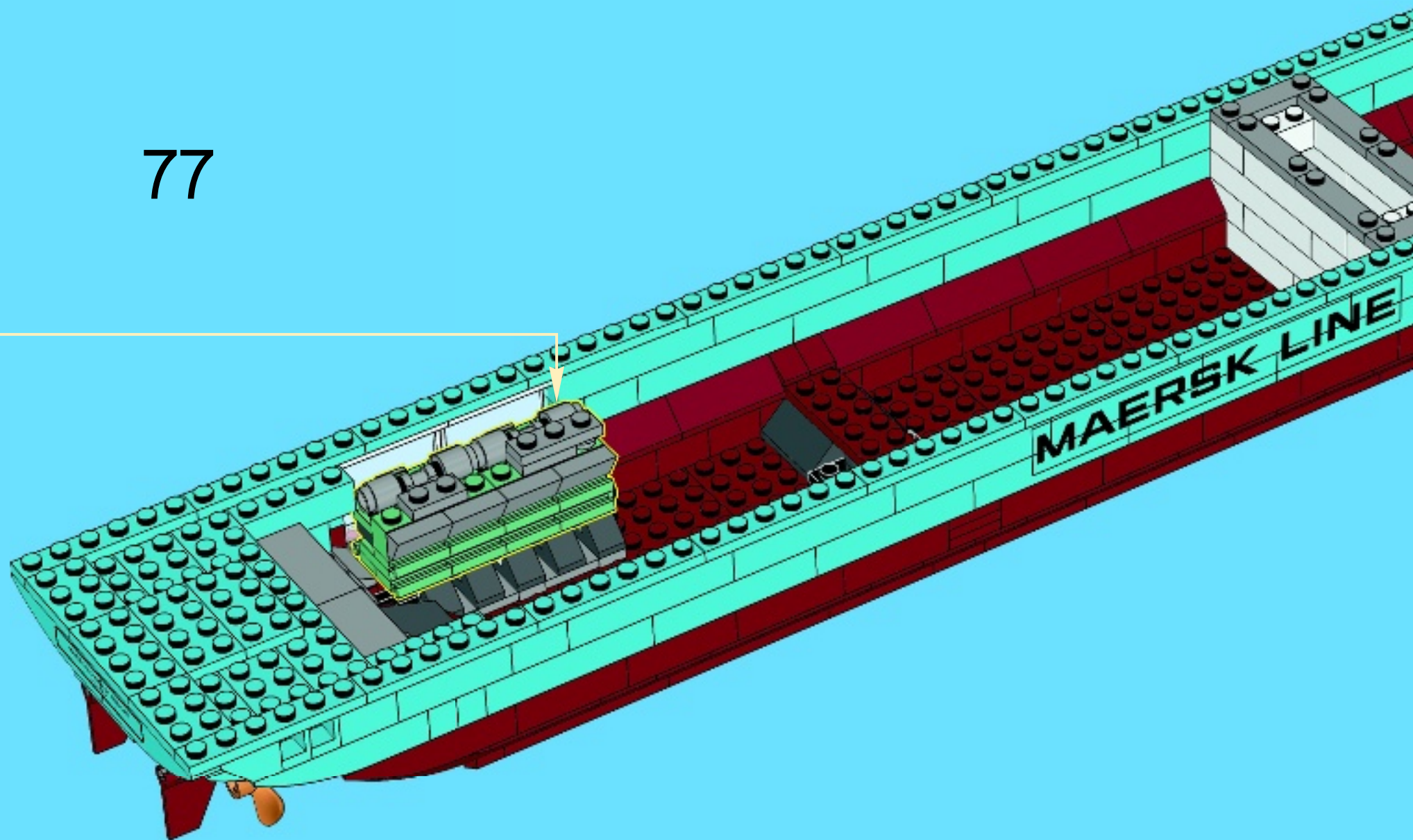

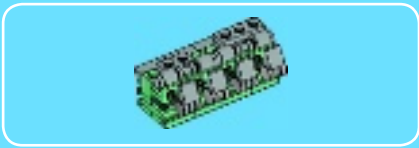

1

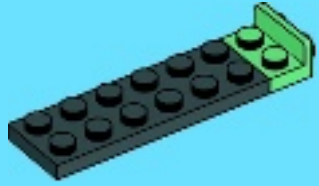

2

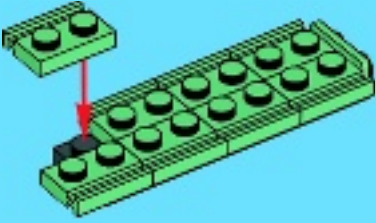

3

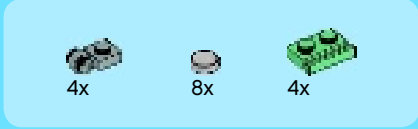
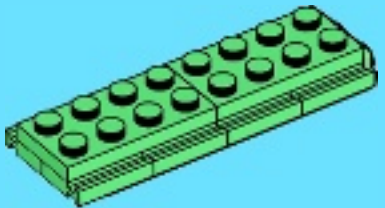

4

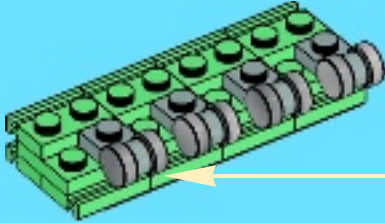
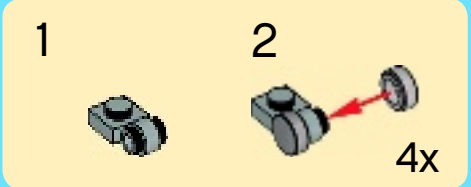

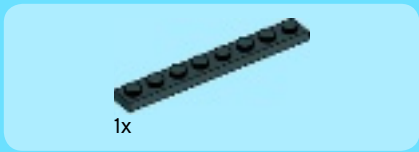

5

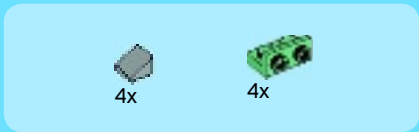
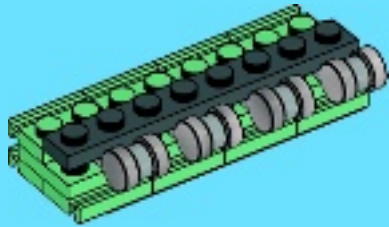

6

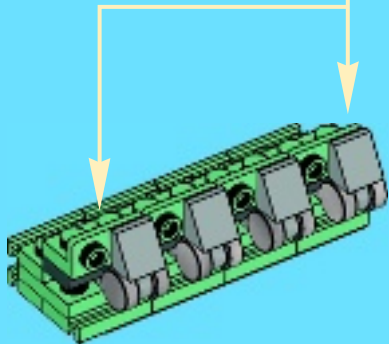
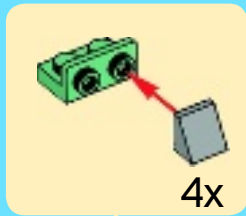

7

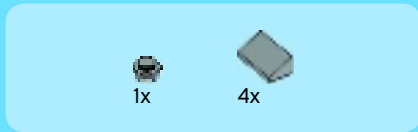
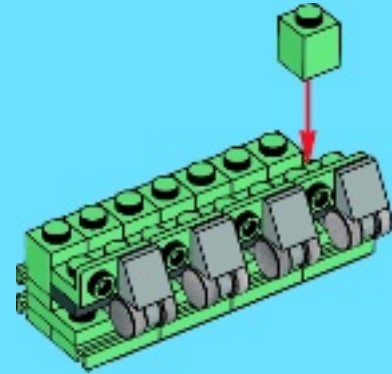

8

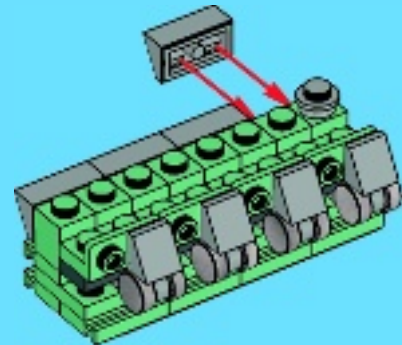



4x



2x

9

1



2

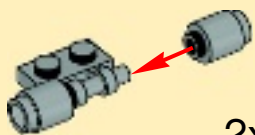

2x

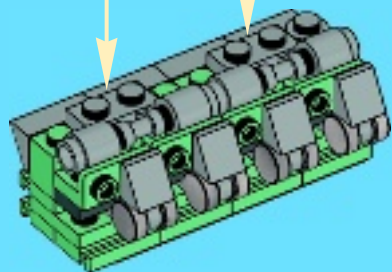

1x

10

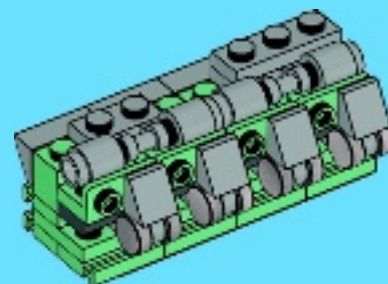

78

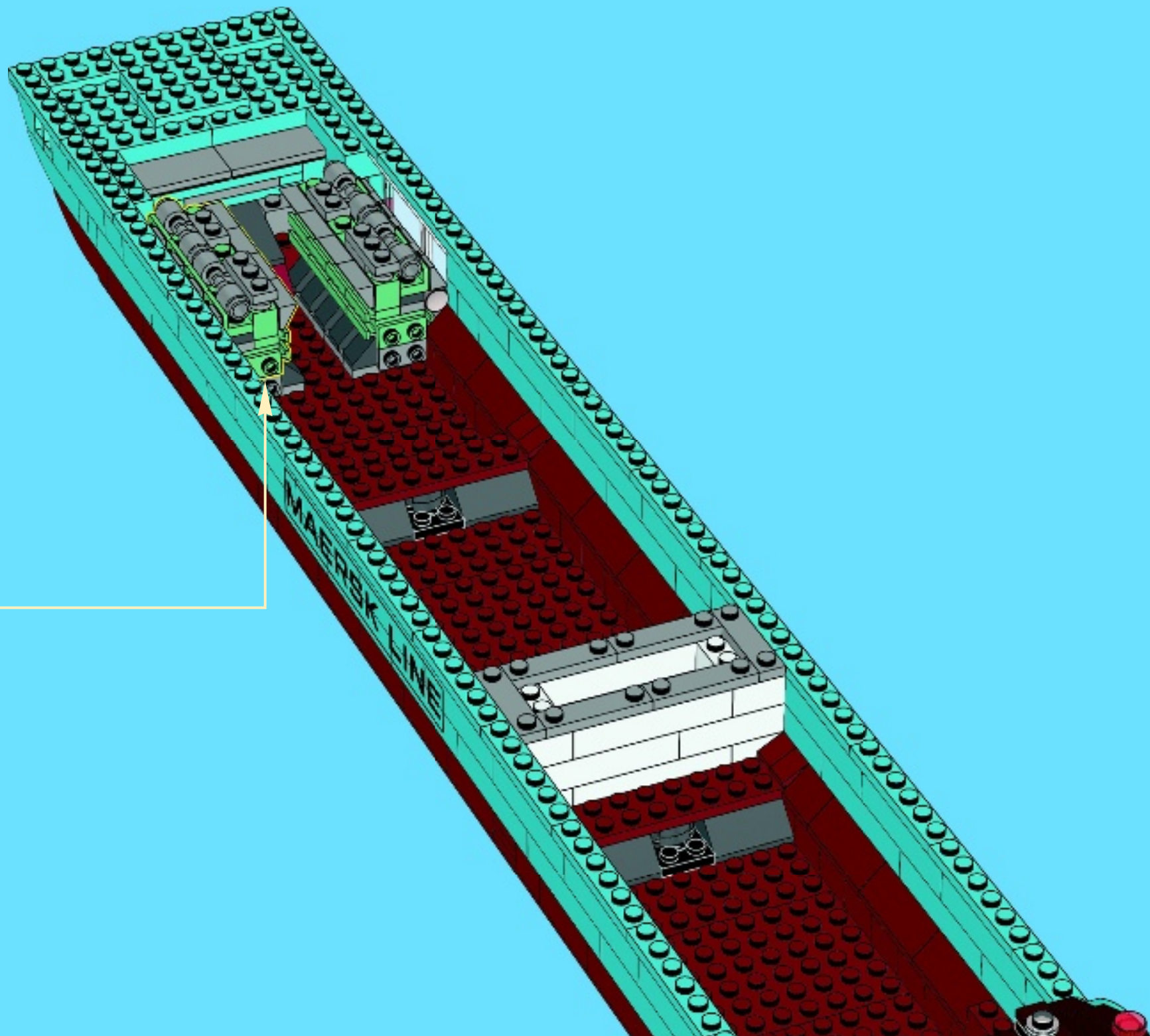



2x

79

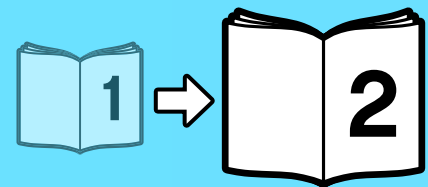
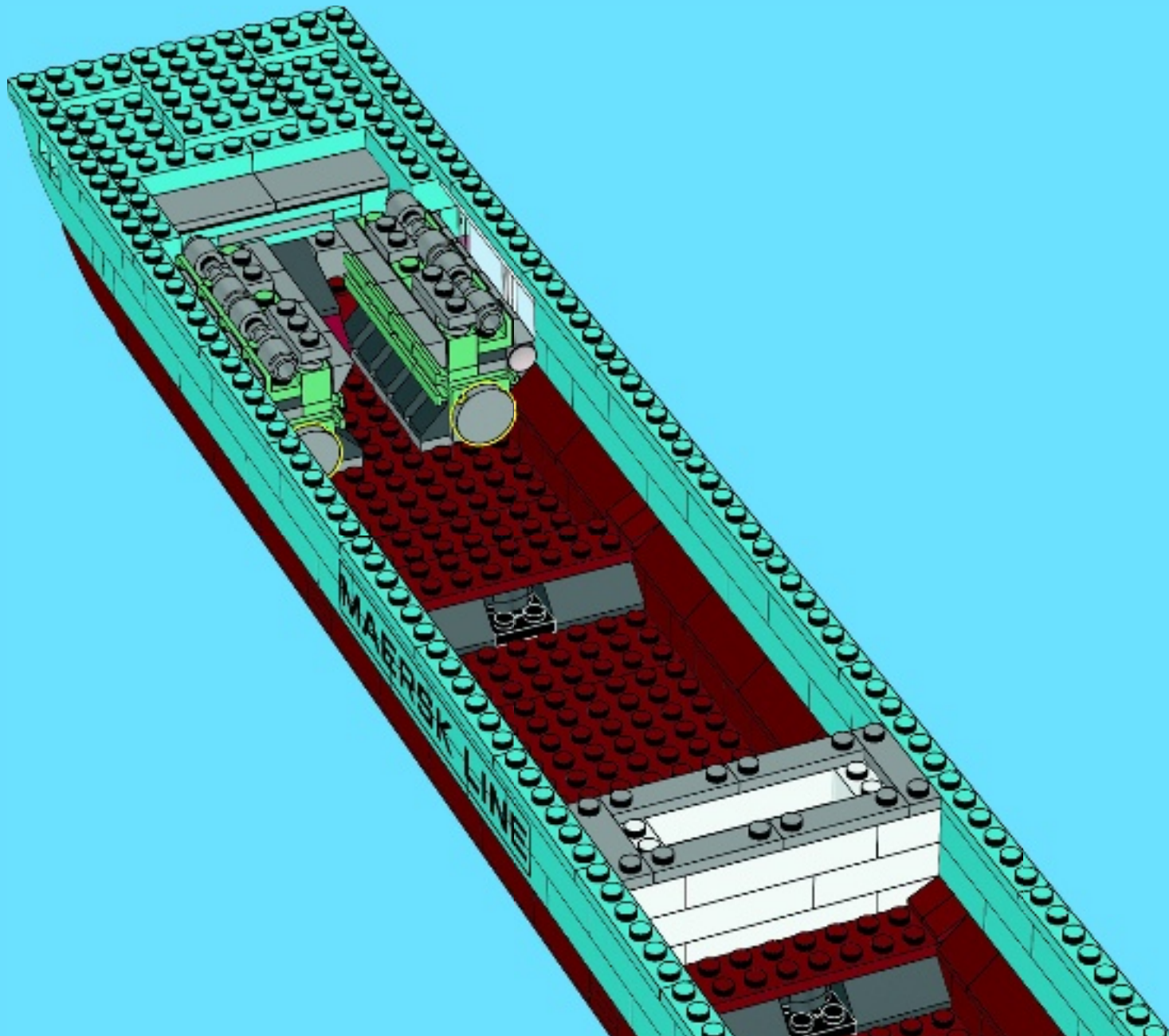



club™

Free*! Gratuit!

* Paid subscription in Australia and New Zealand.
Abonnement payant en Australie et Nouvelle-Zélande.

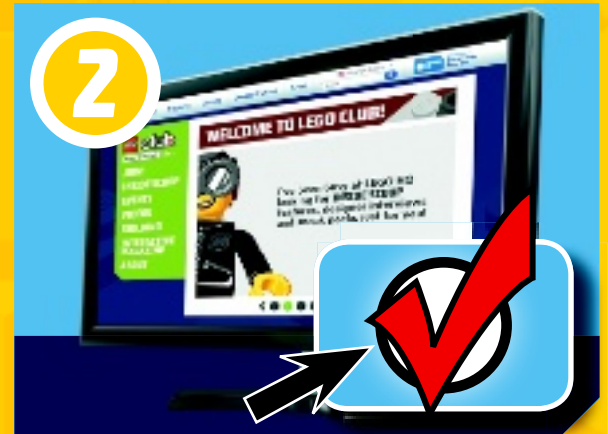

LEGO.com/club





CREATOR

10241



EXPERT

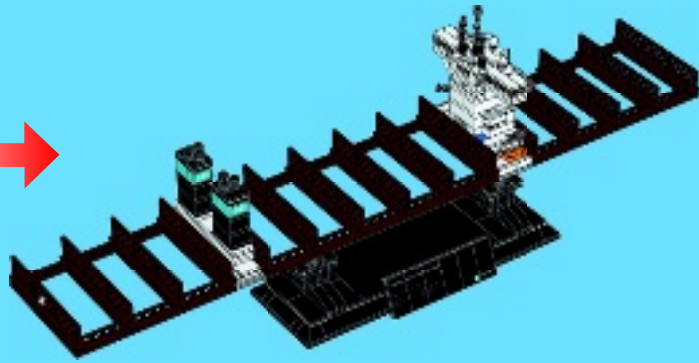

8x

80

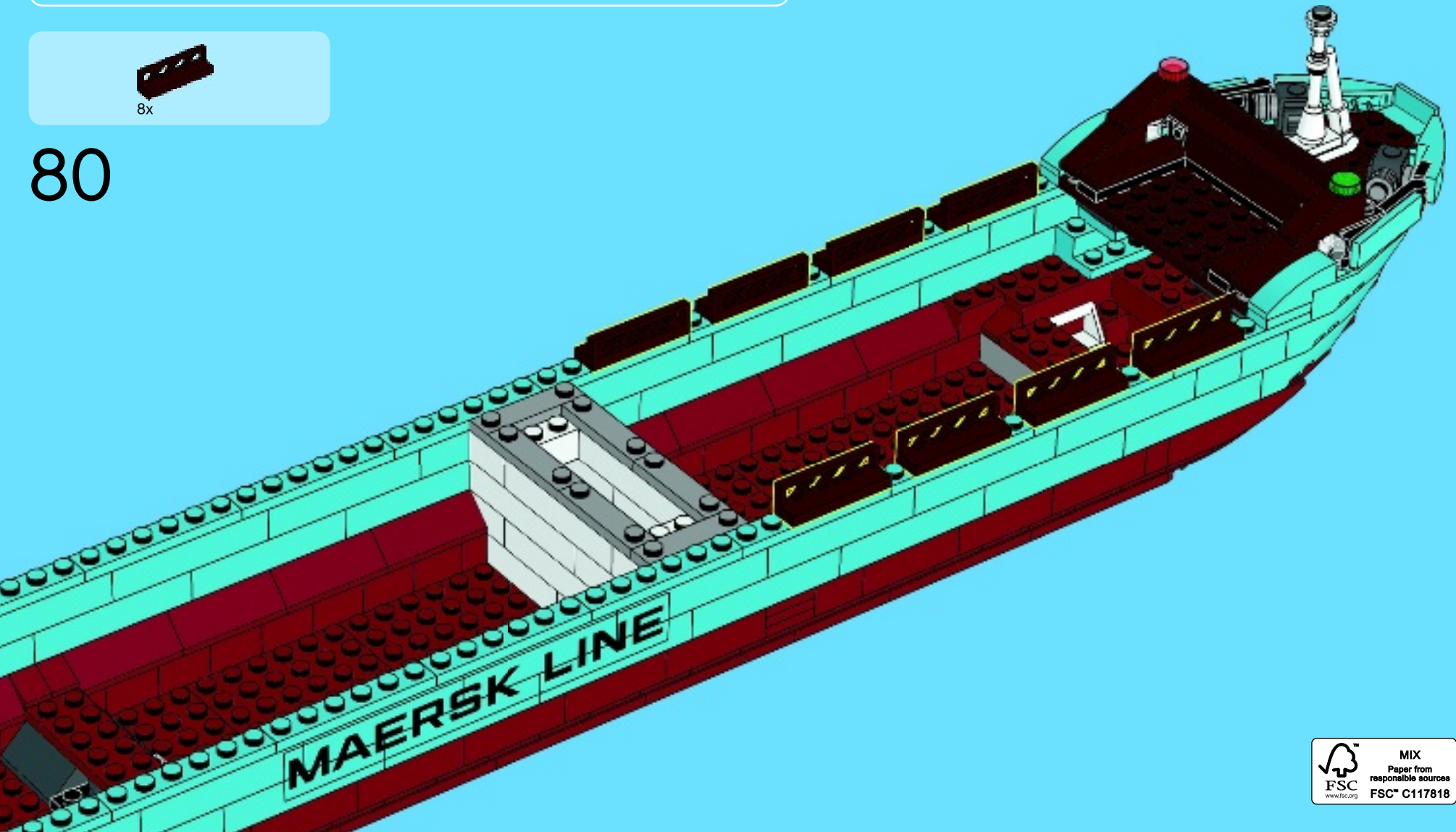

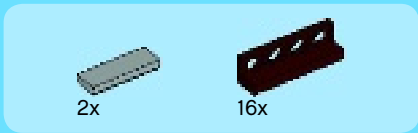

81

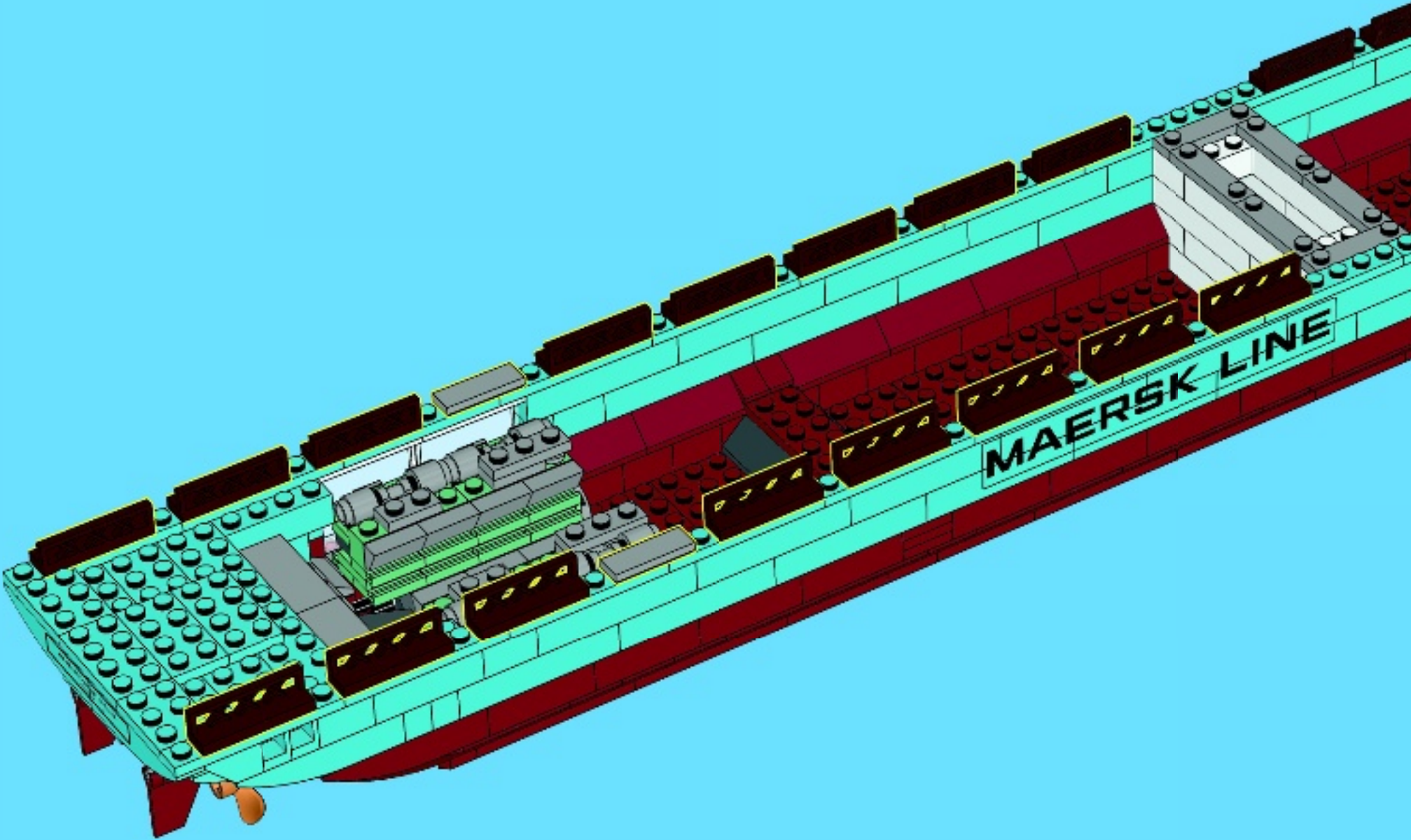

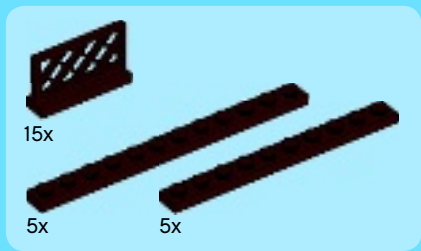

82

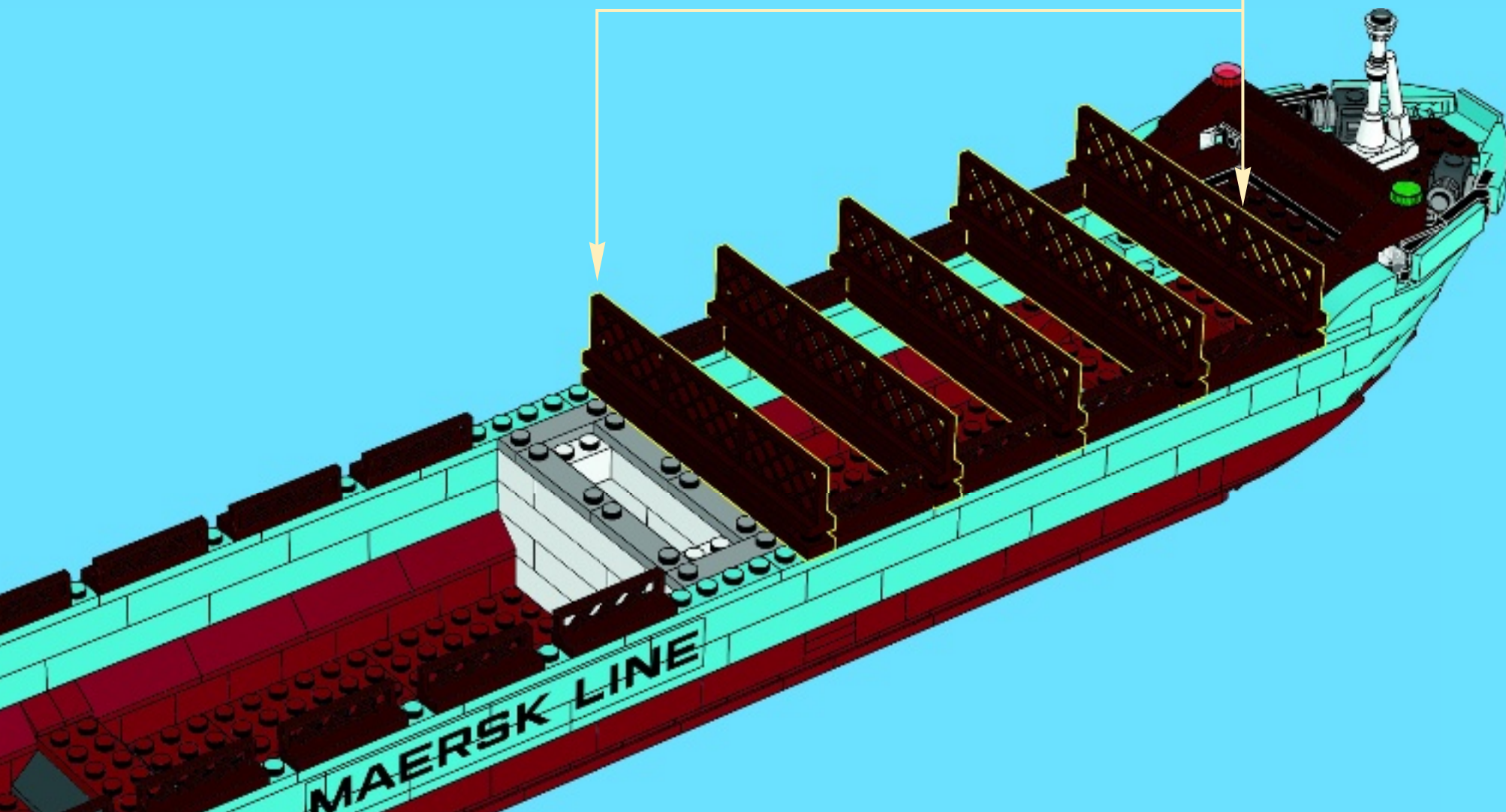
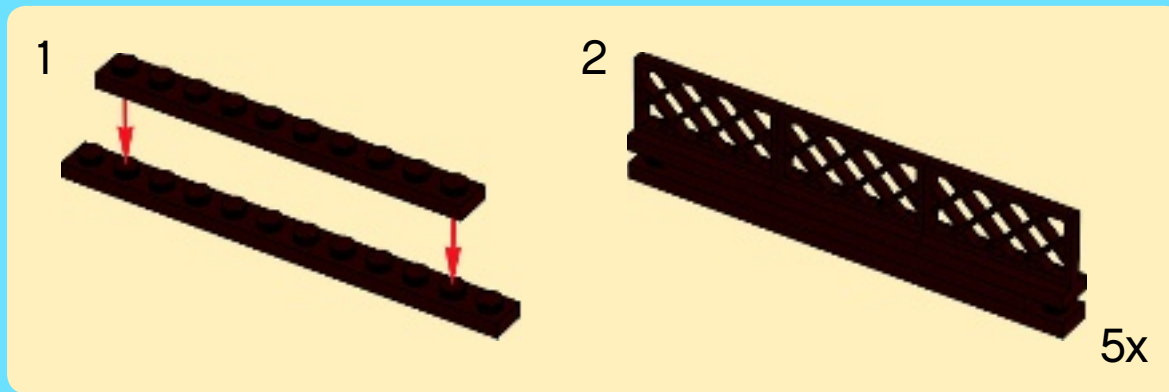

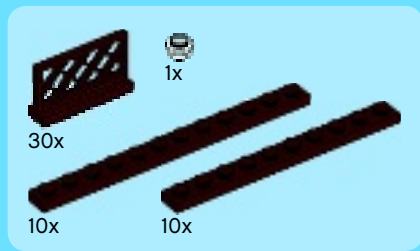

83

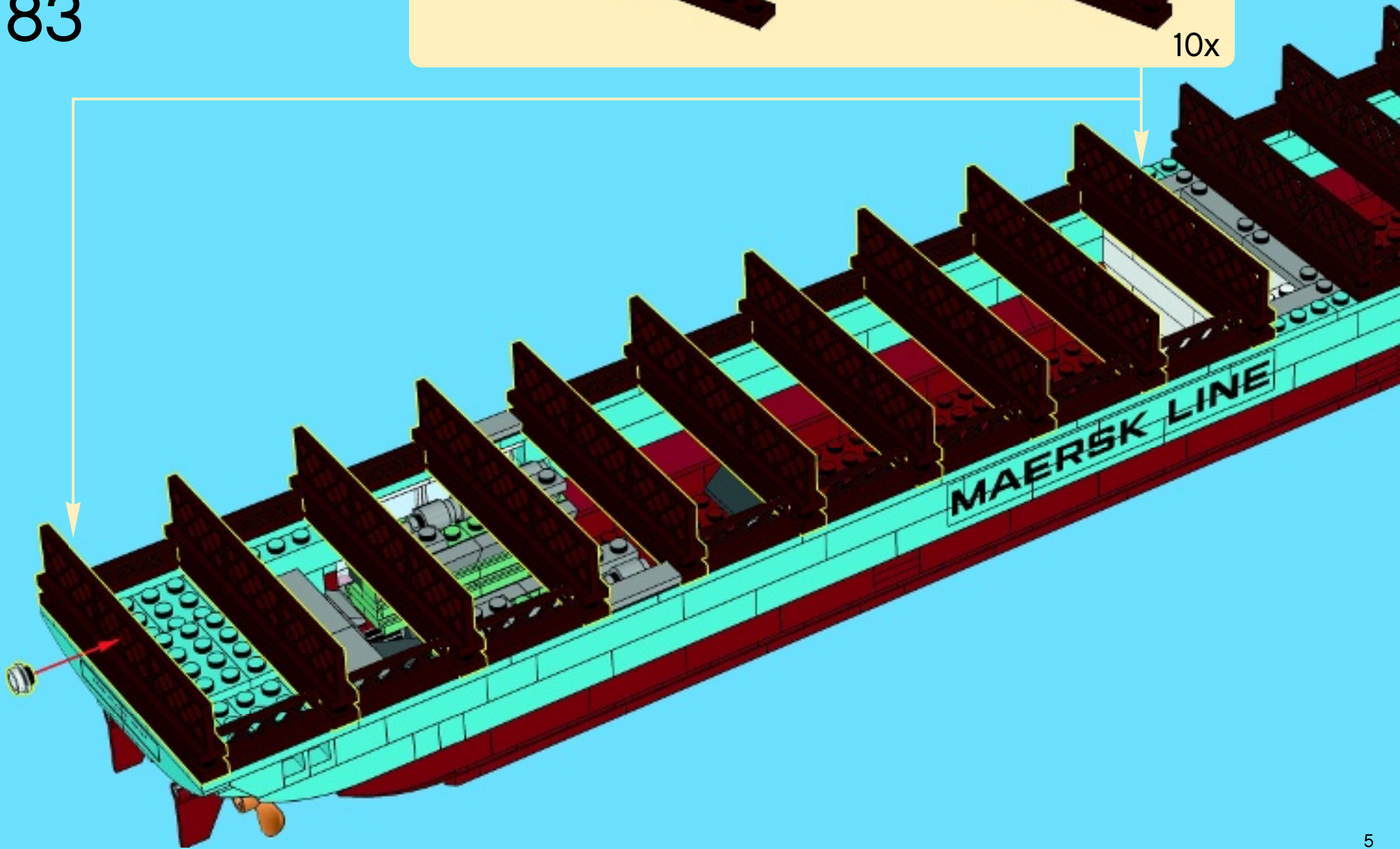
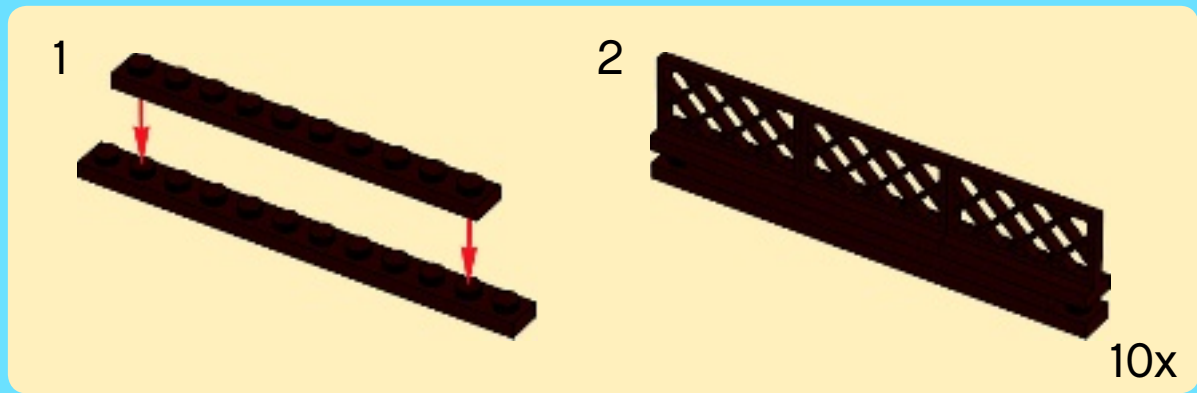

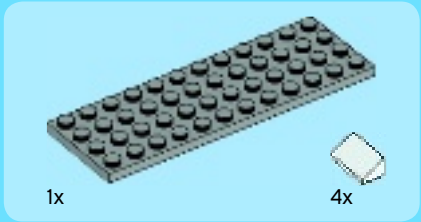
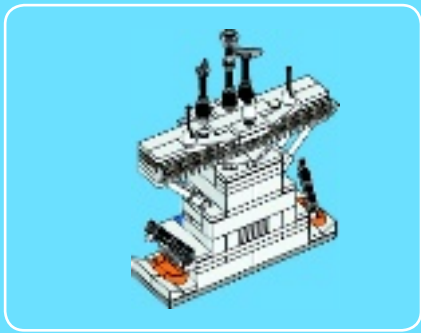

1

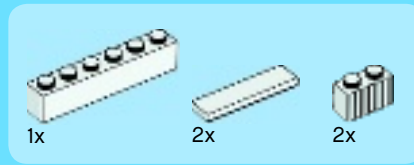
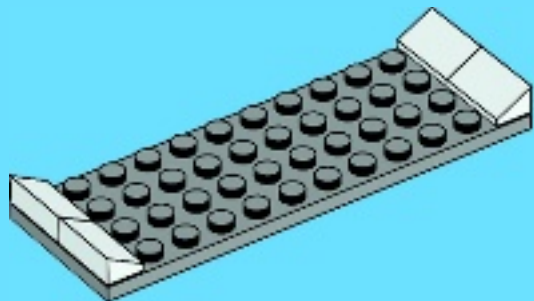

2

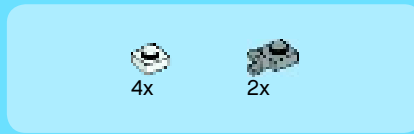
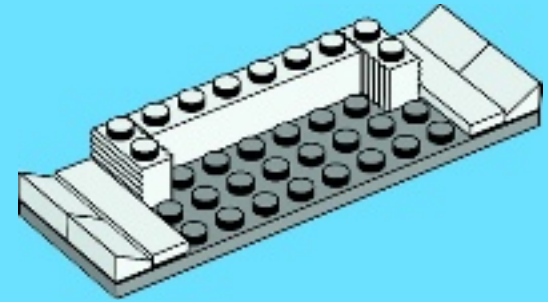

3

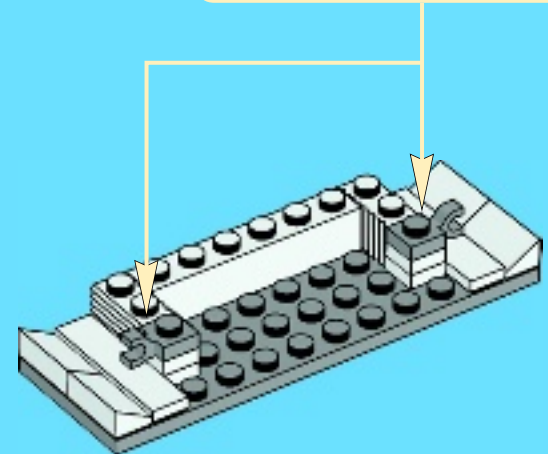
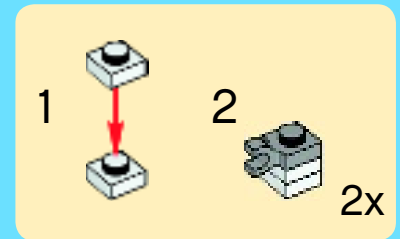



2x

4

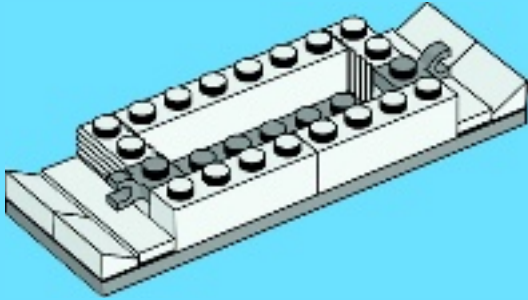

2x



2x



2x

5

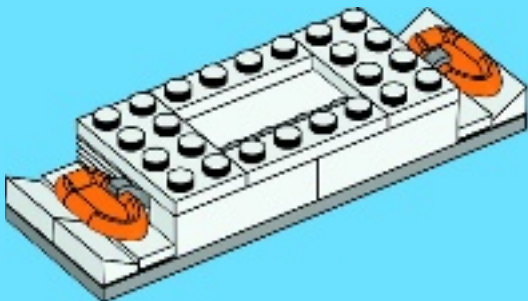

2x



2x



1x



2x



1x

6

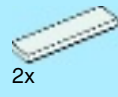
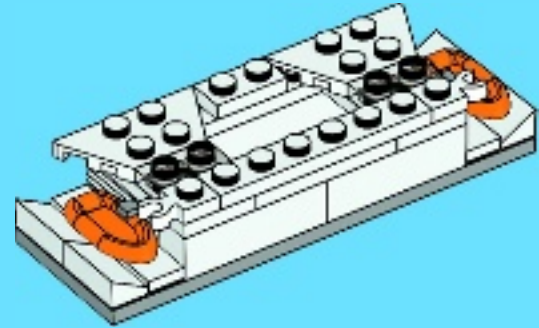

2x



1x



1x

7

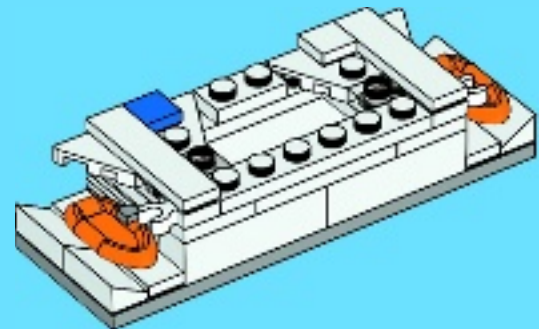

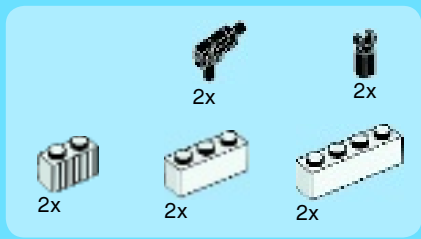

8

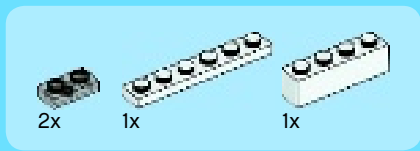
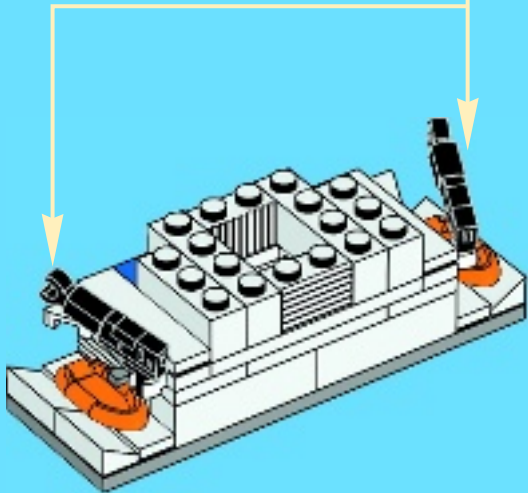
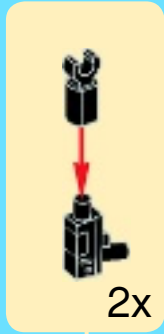

9

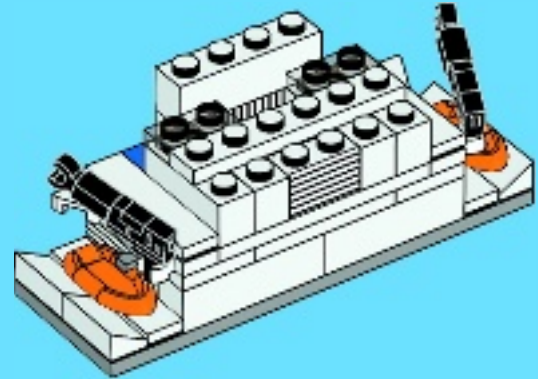

10

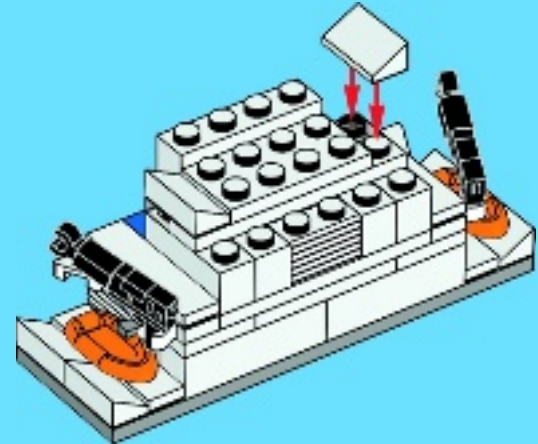

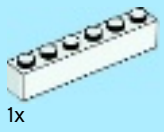

1x



1x

11

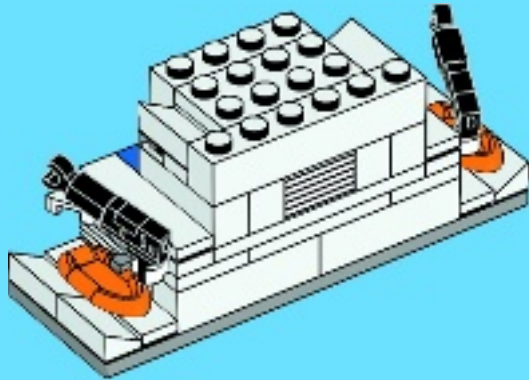

2x



2x



4x

12

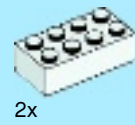
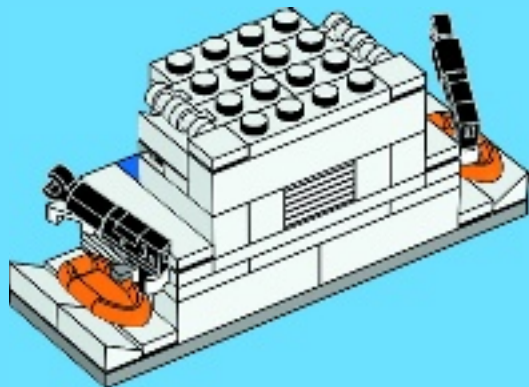

2x



4x



4x

13

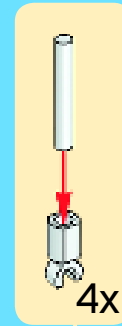

4x

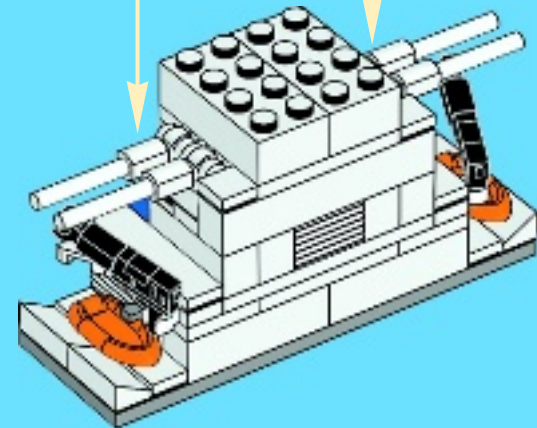

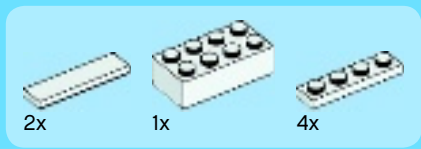

14

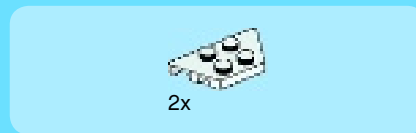
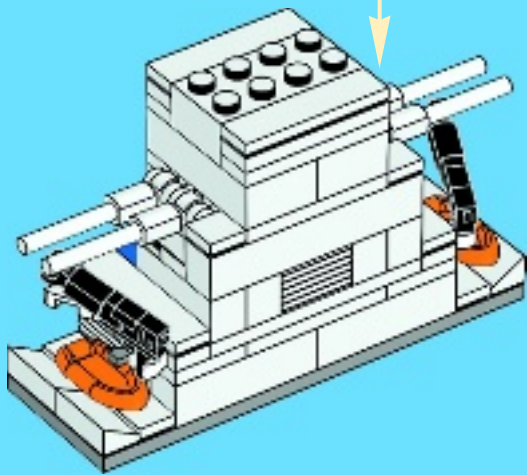
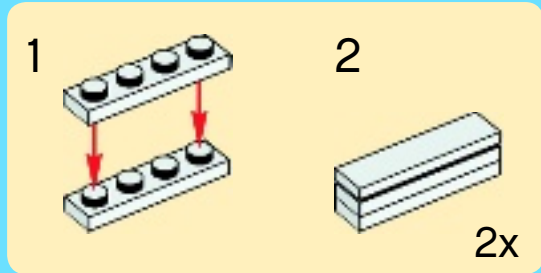

15

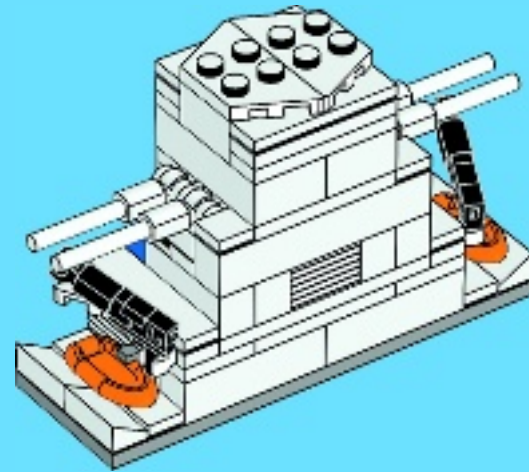

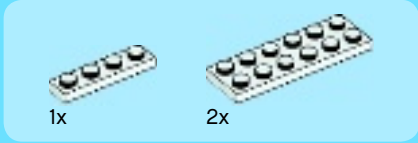
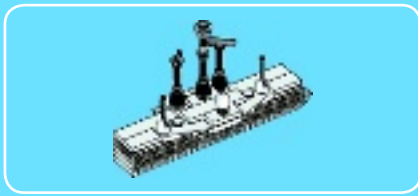

1

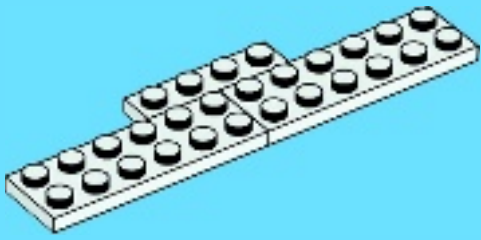

2

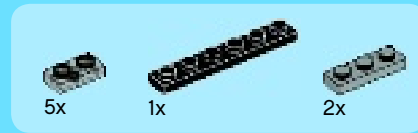
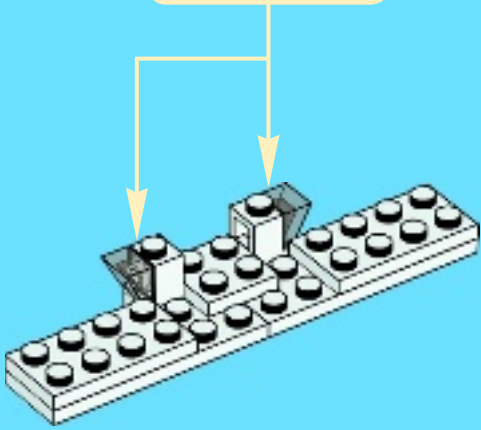
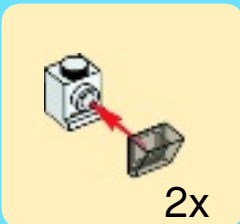

3

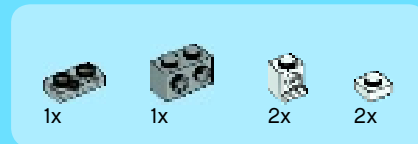
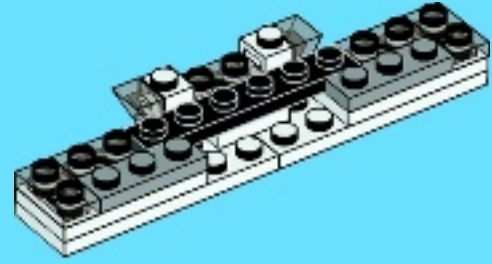

4

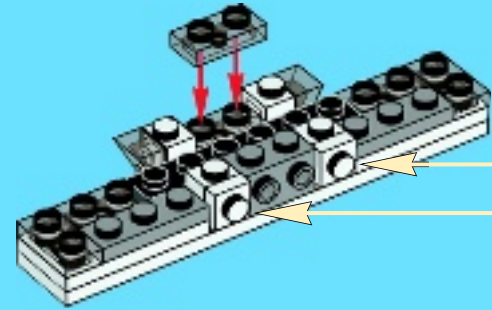
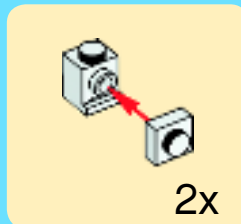

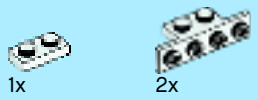

5

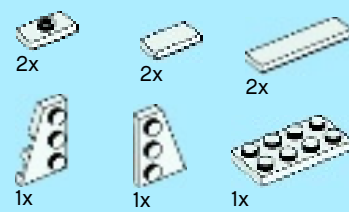
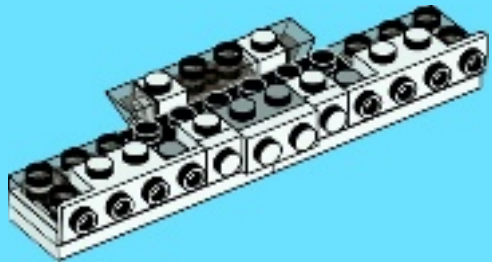

7

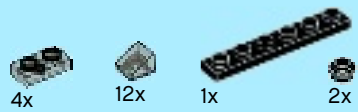
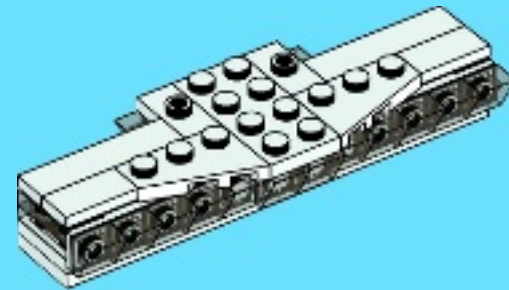

6



8

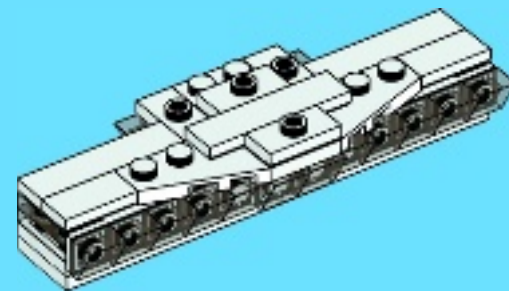

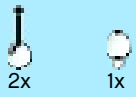

9

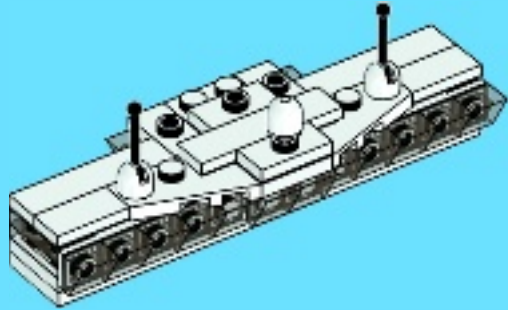

11

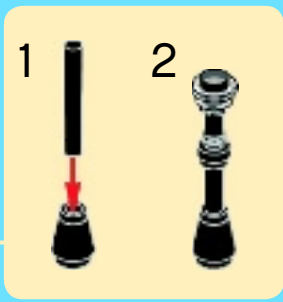
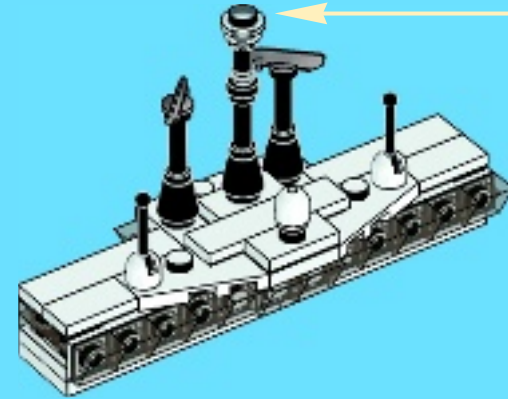

10

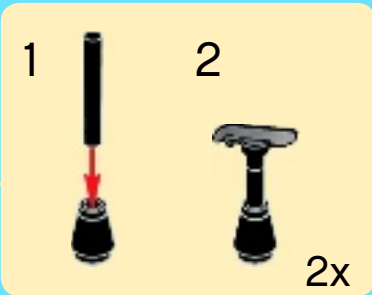
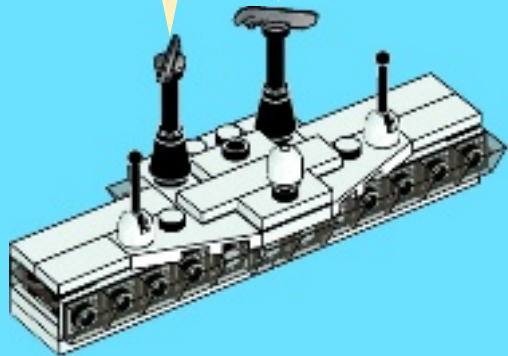

16

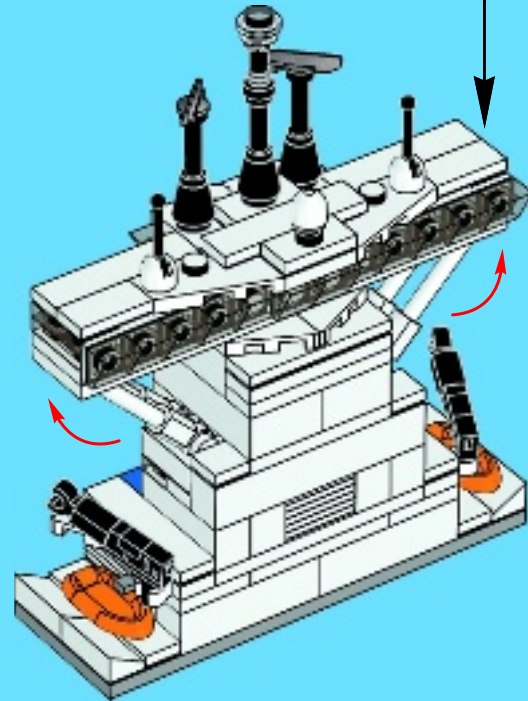

84



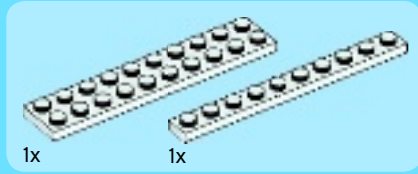
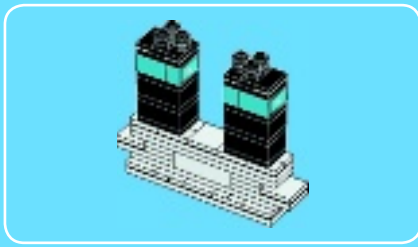

1

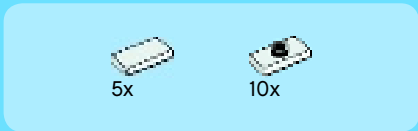
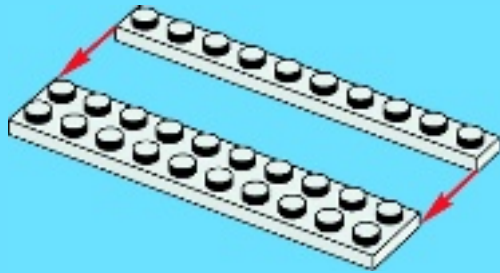

2

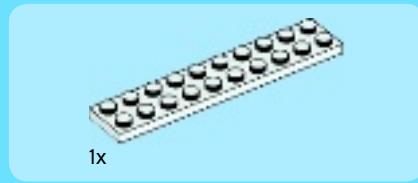
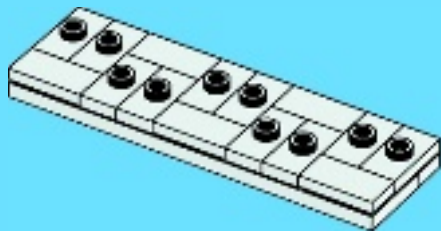

3

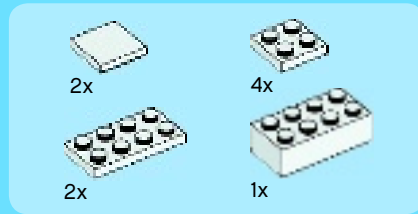
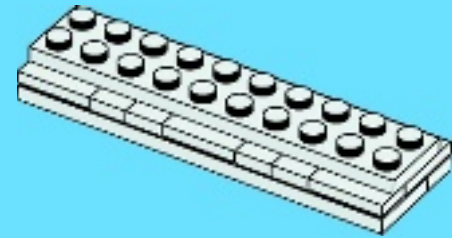

4

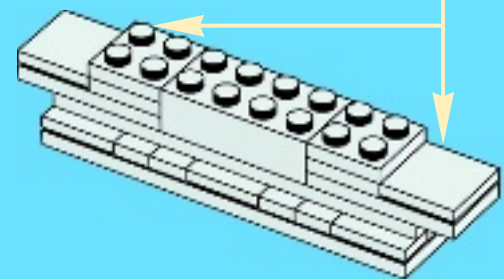
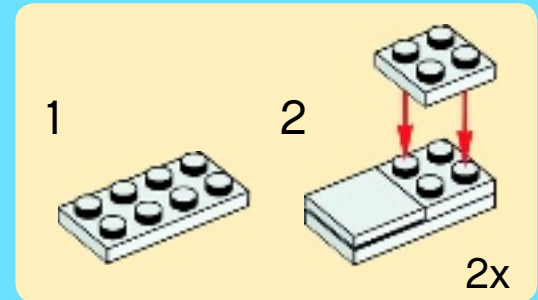

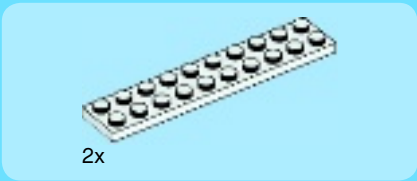

5

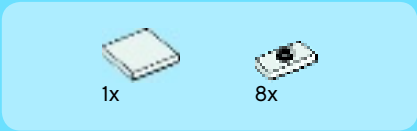
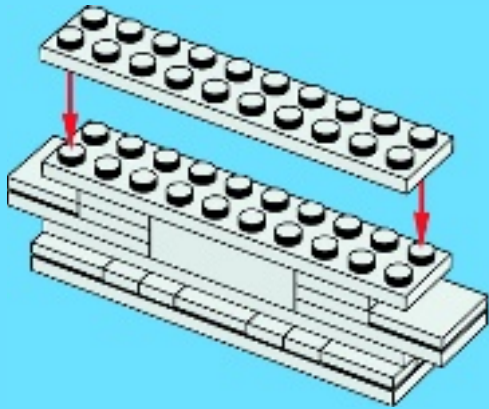

6

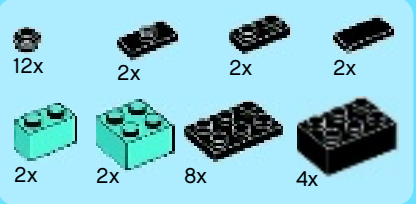
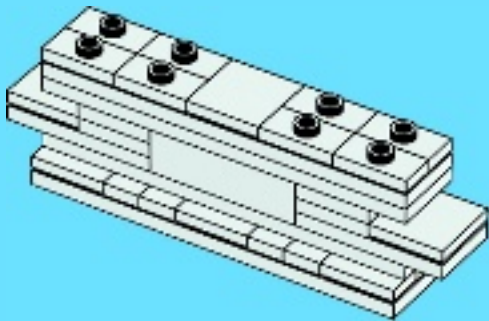

7

1

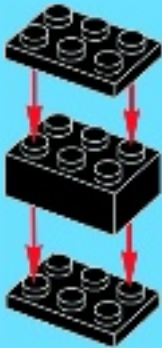

2

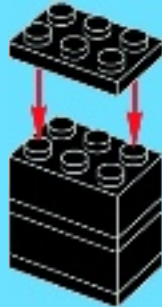

3



4

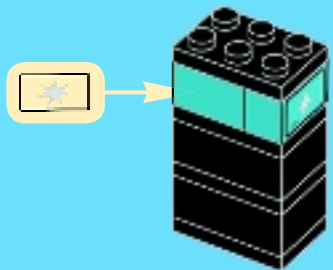

5

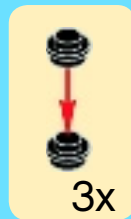

6



2x

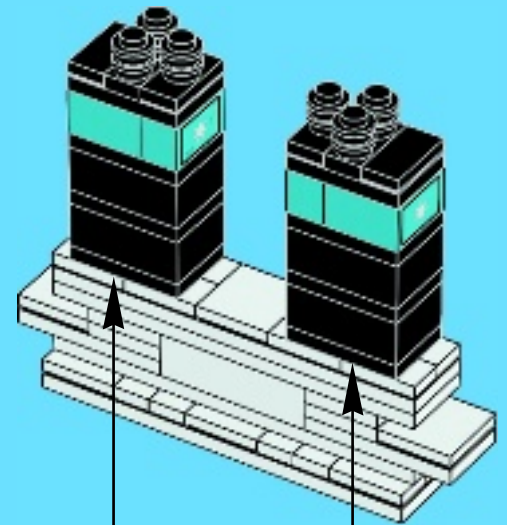

85

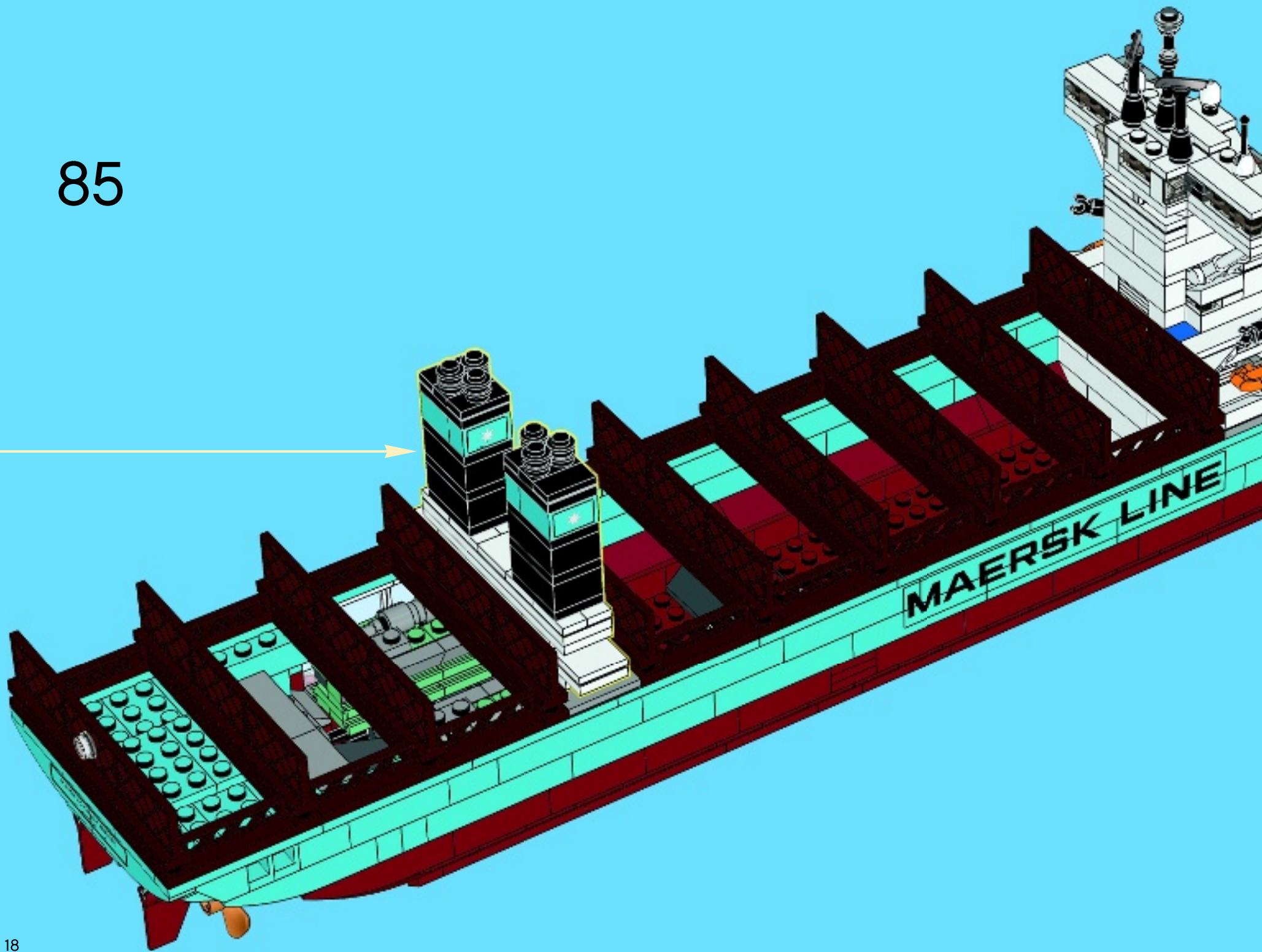

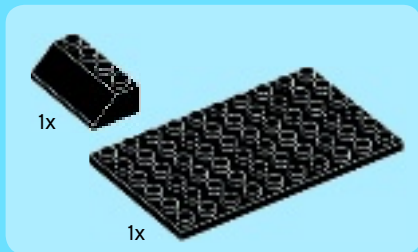
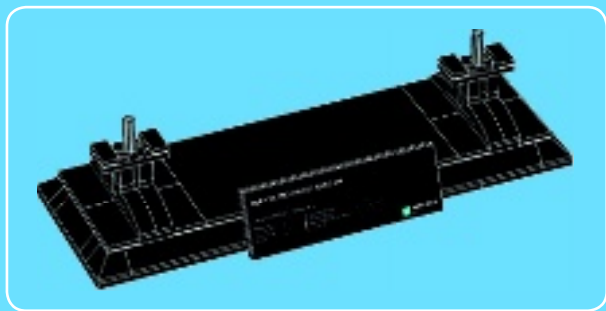

1



2

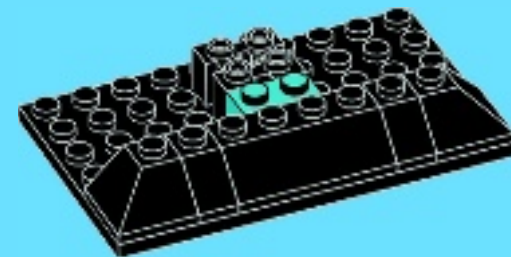

3

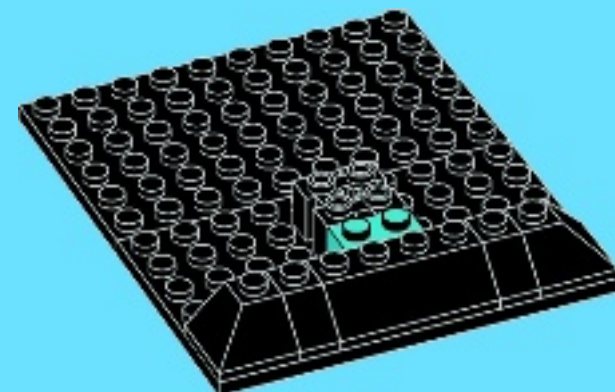

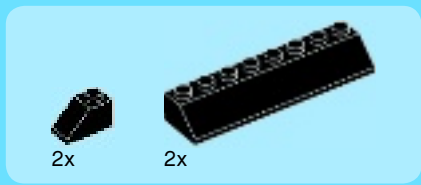

4

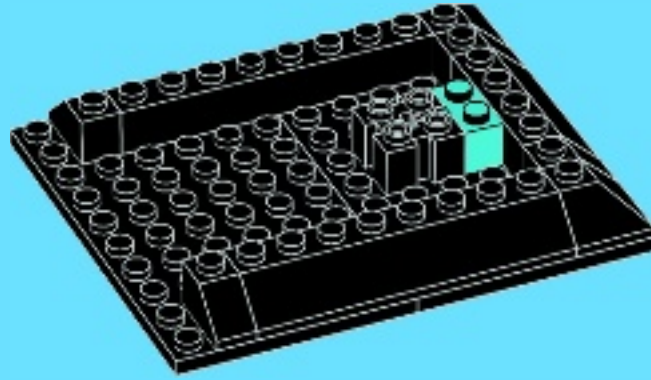

5

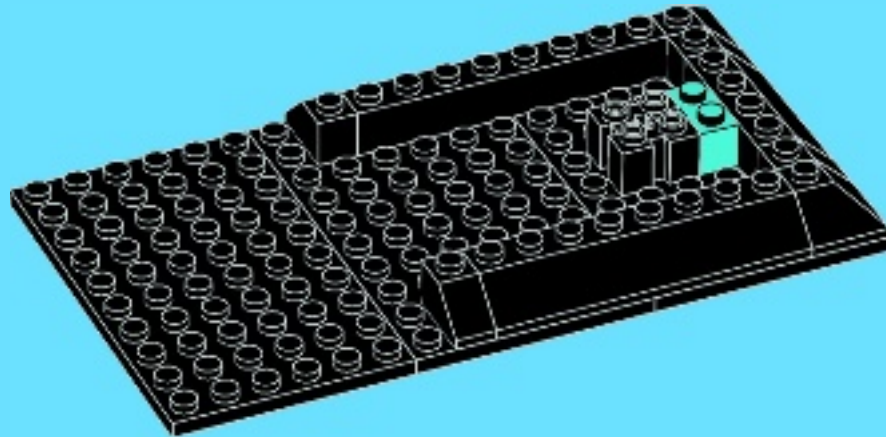

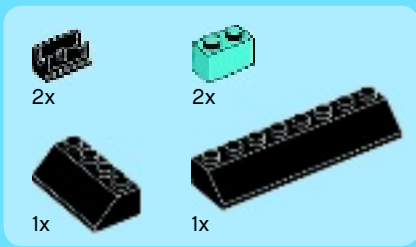

6

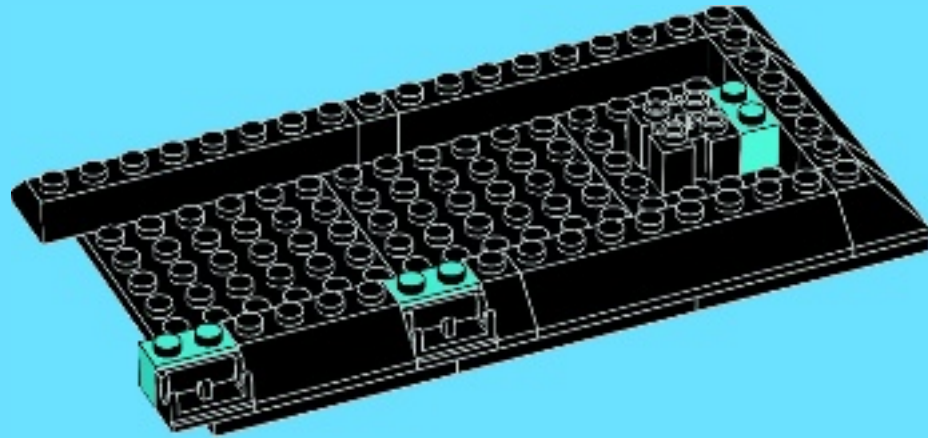

7

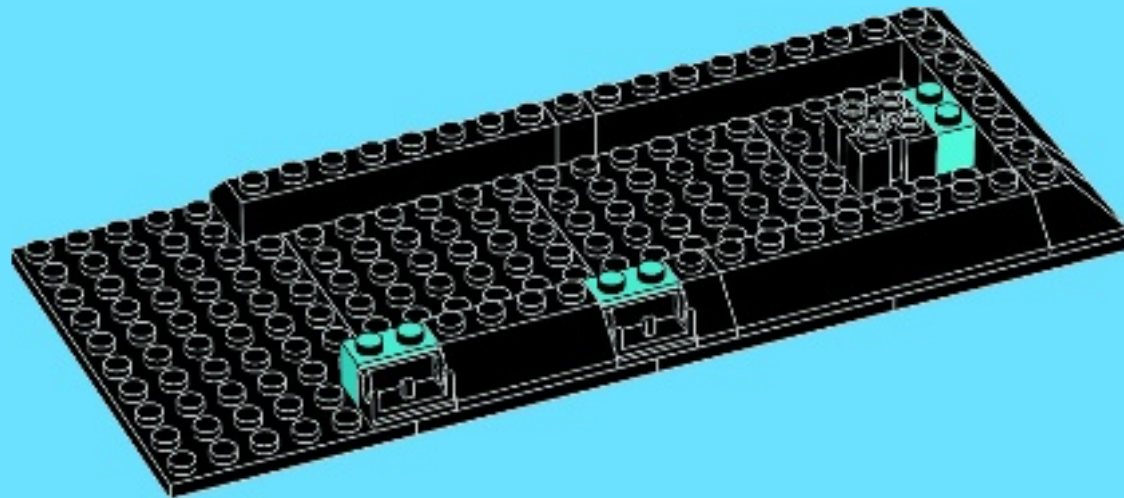



8

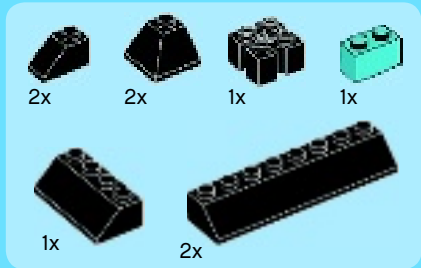
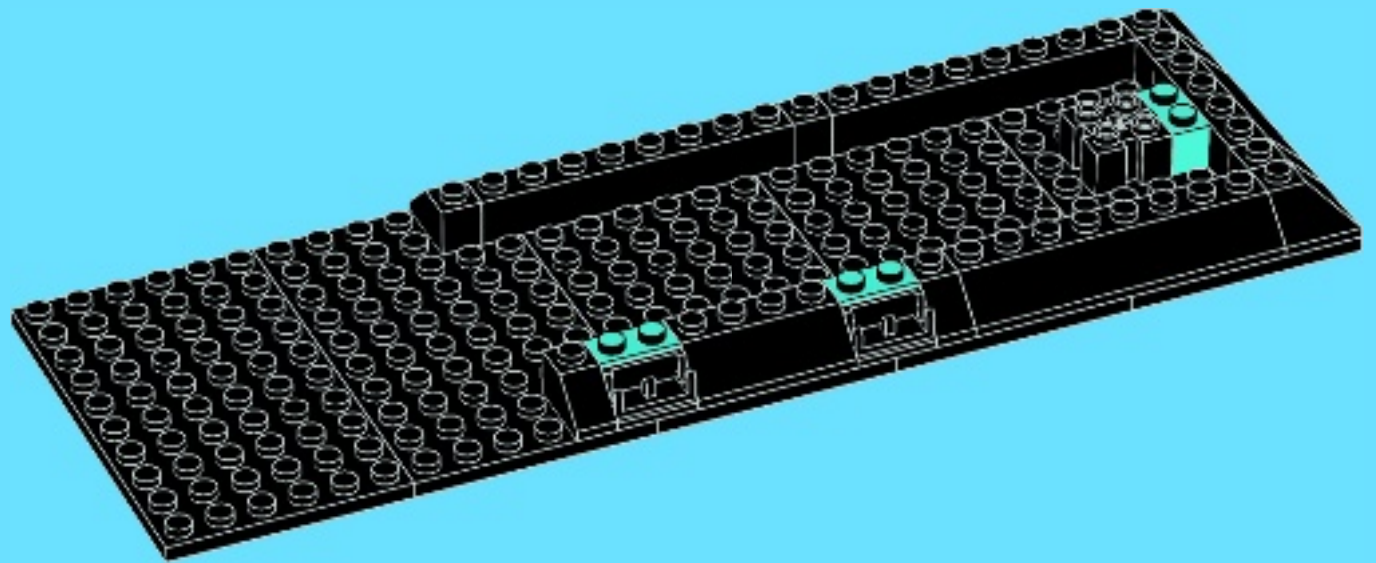

9

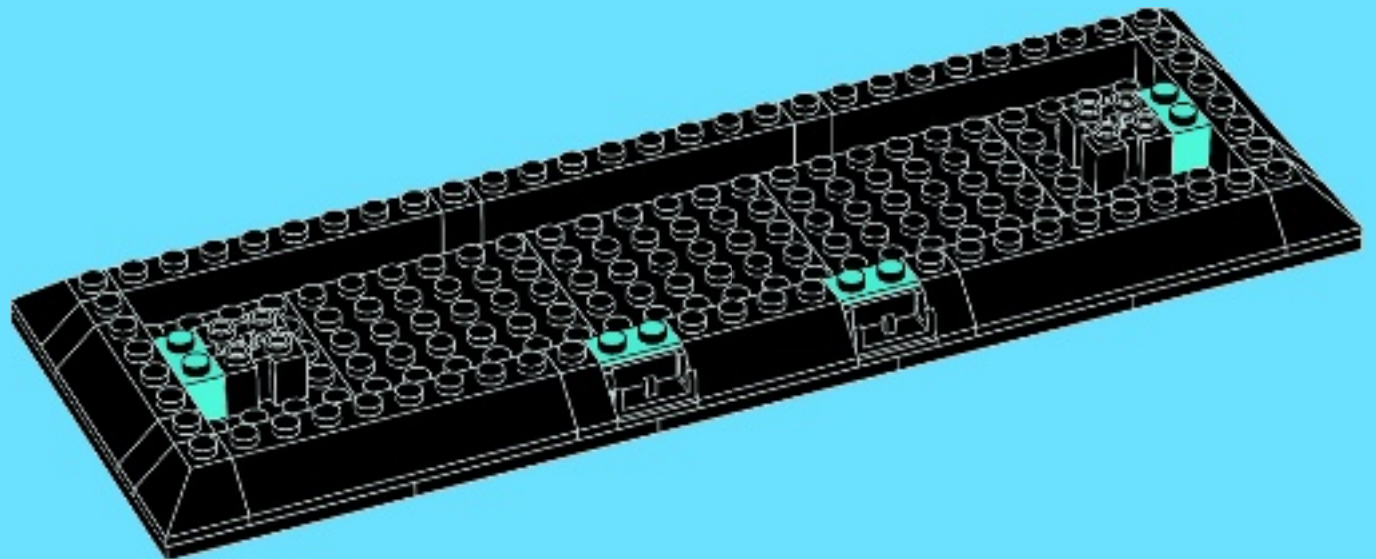

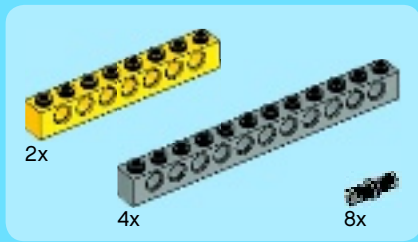

10

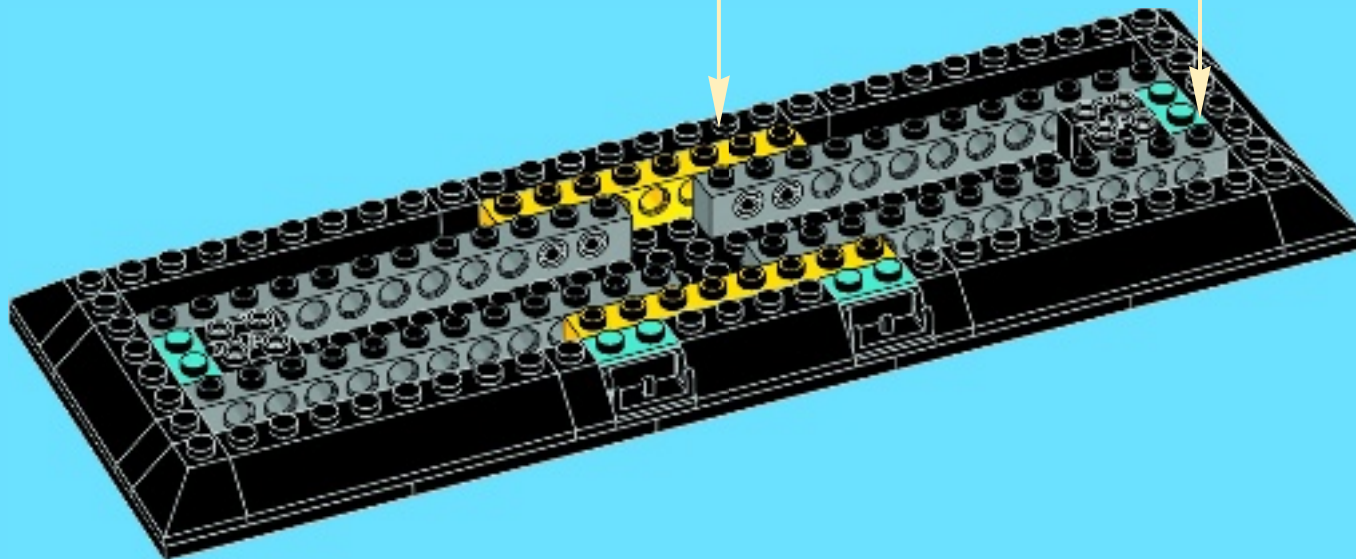
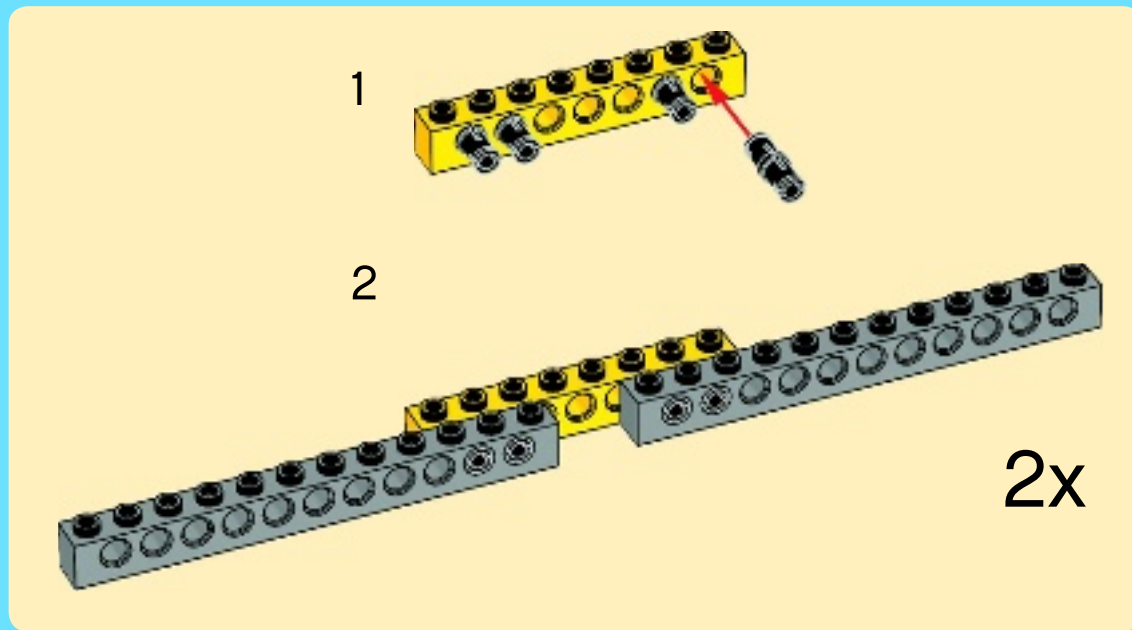

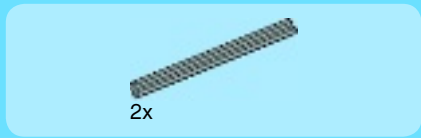

11

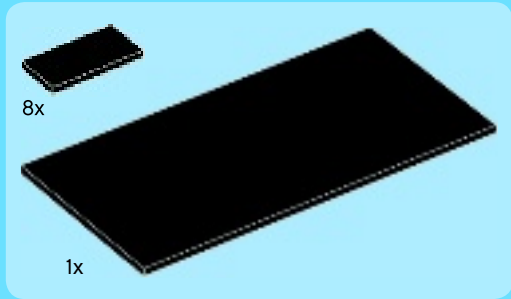
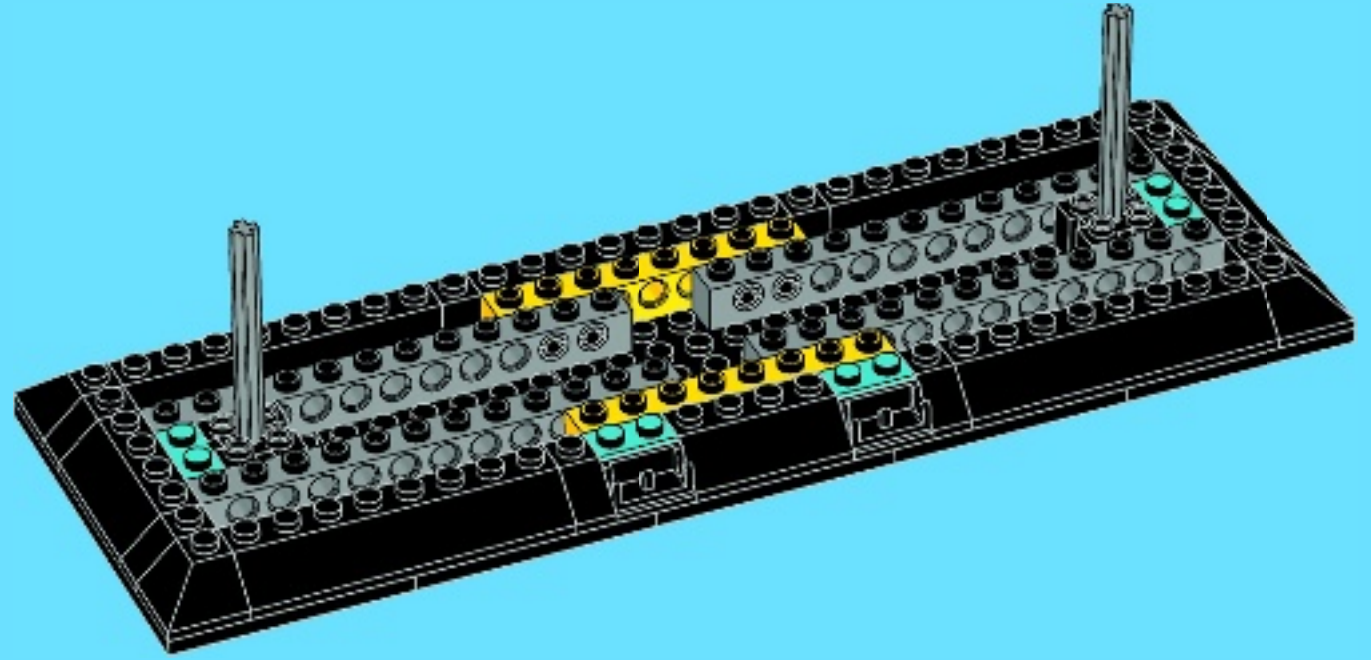

12

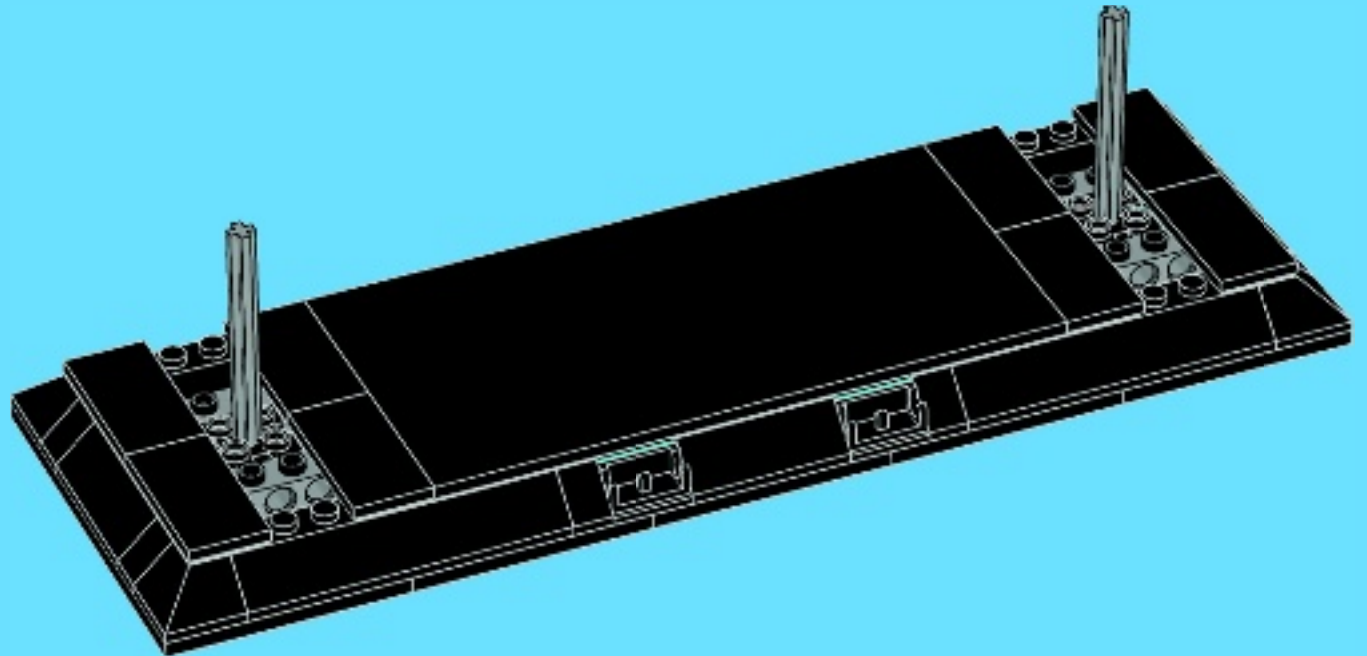

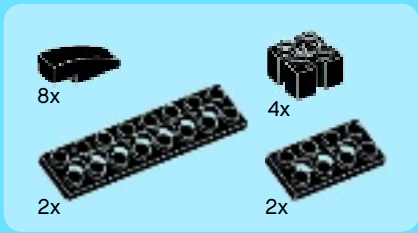

13

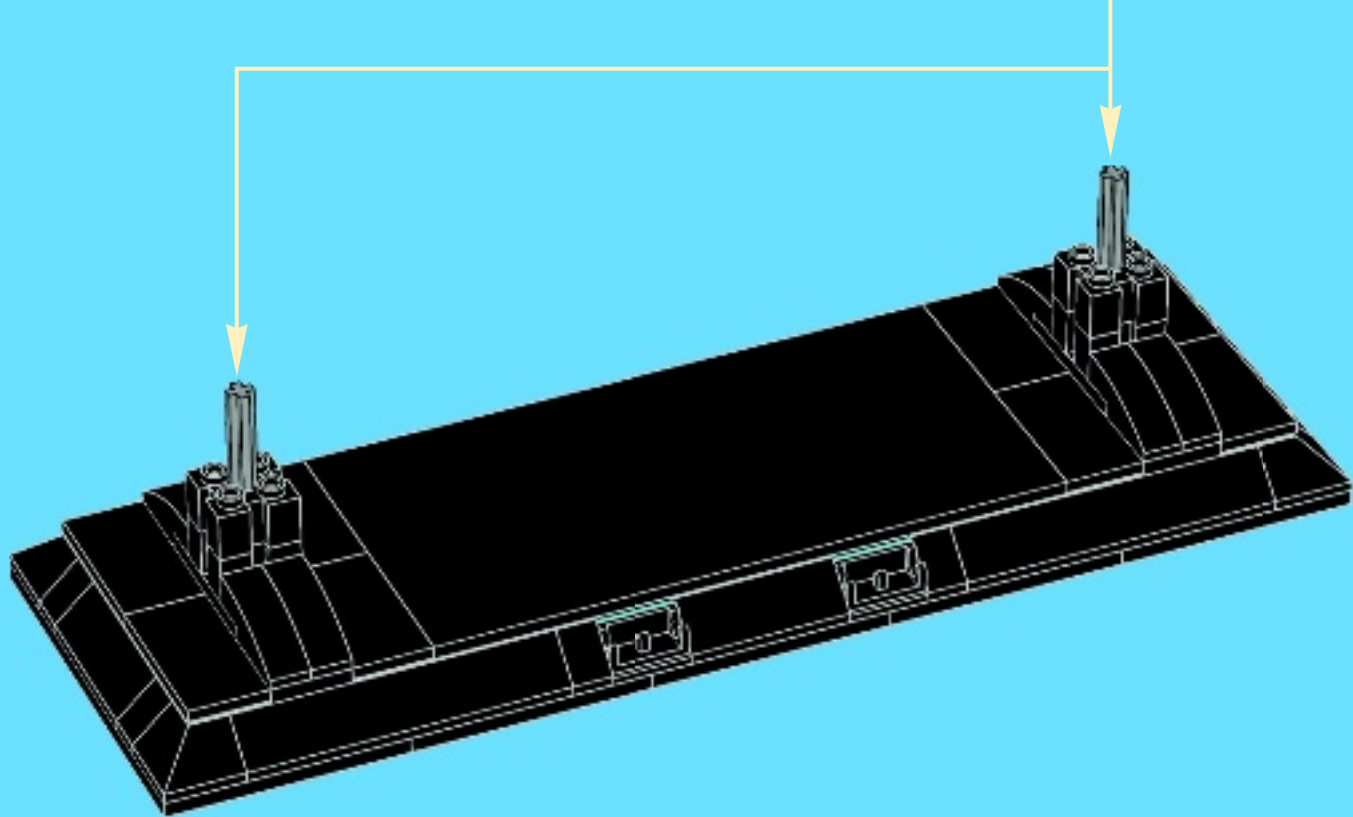
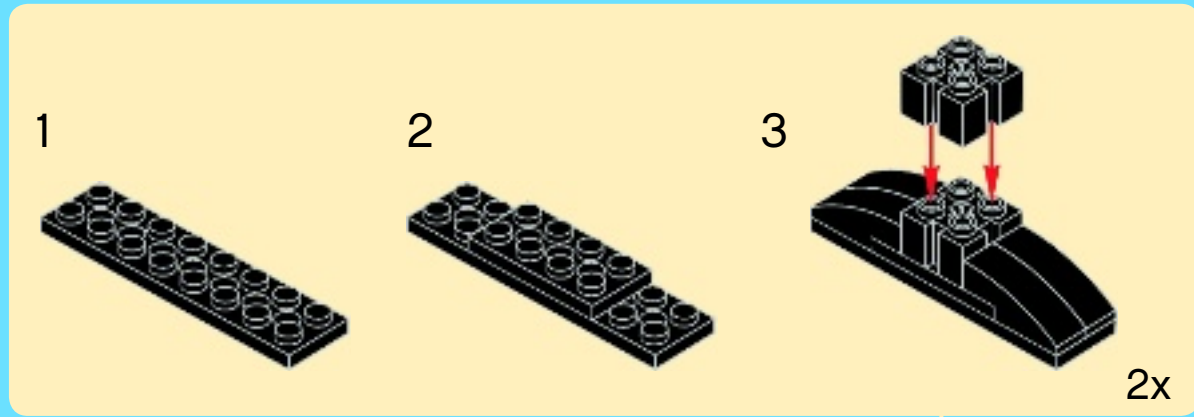



14

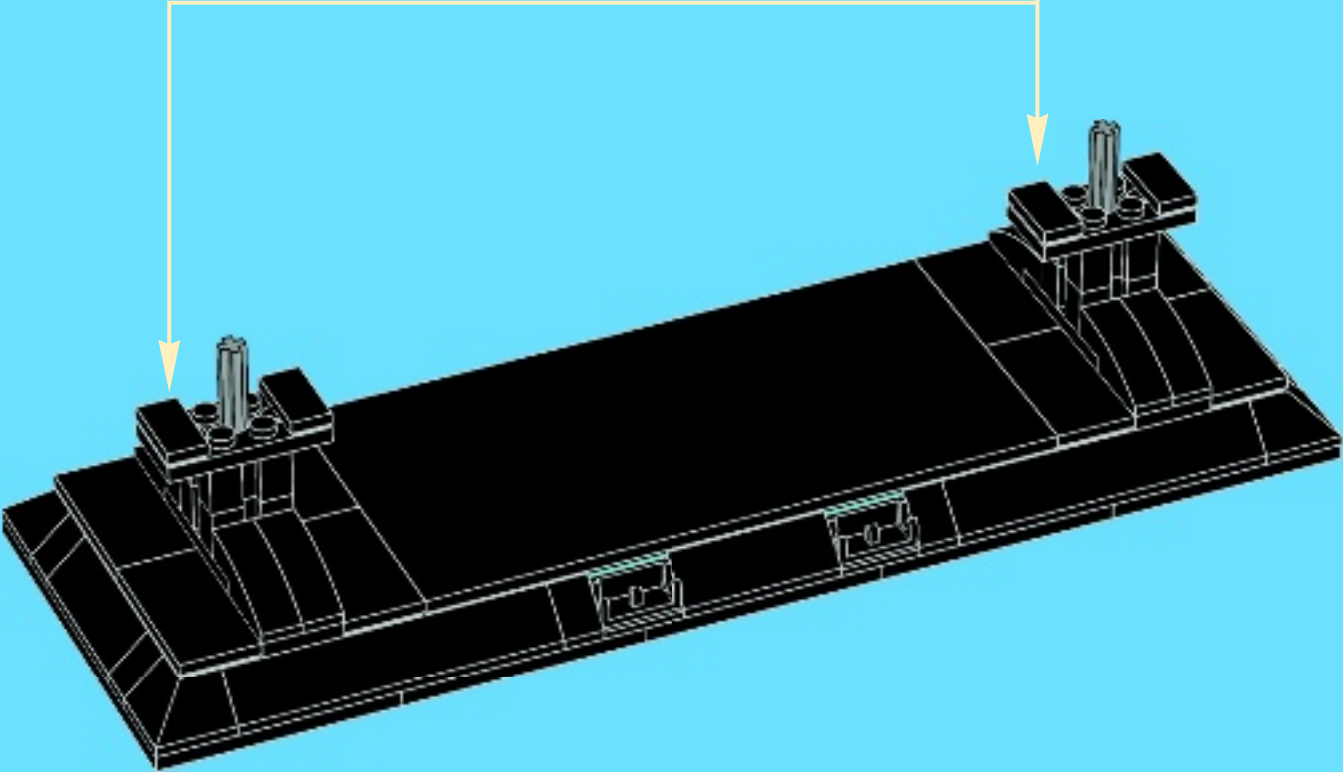
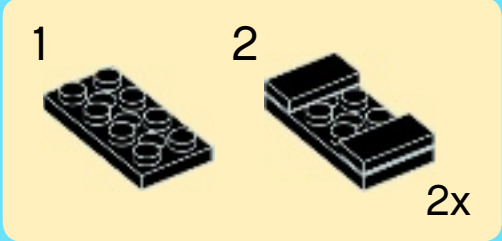

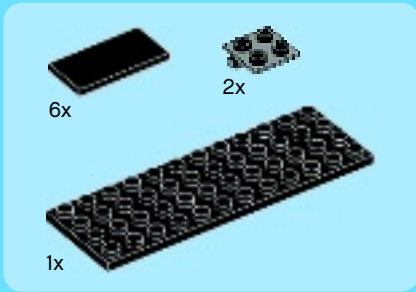

15

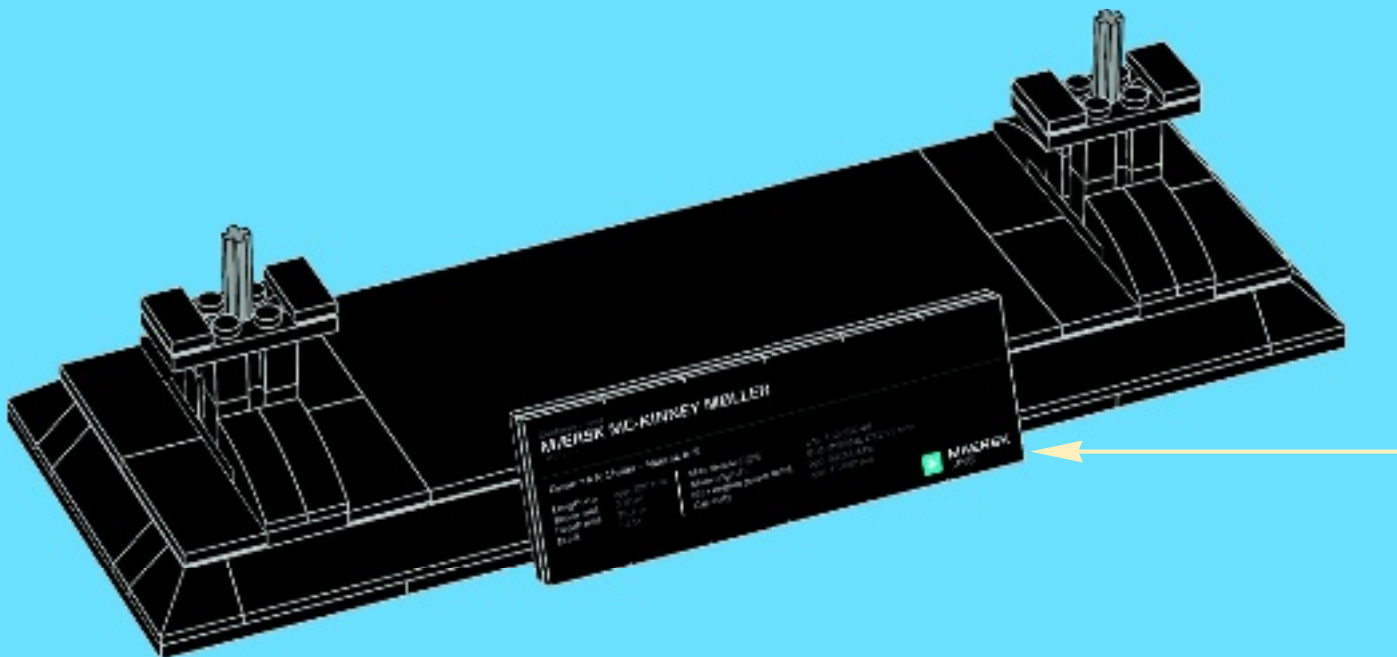
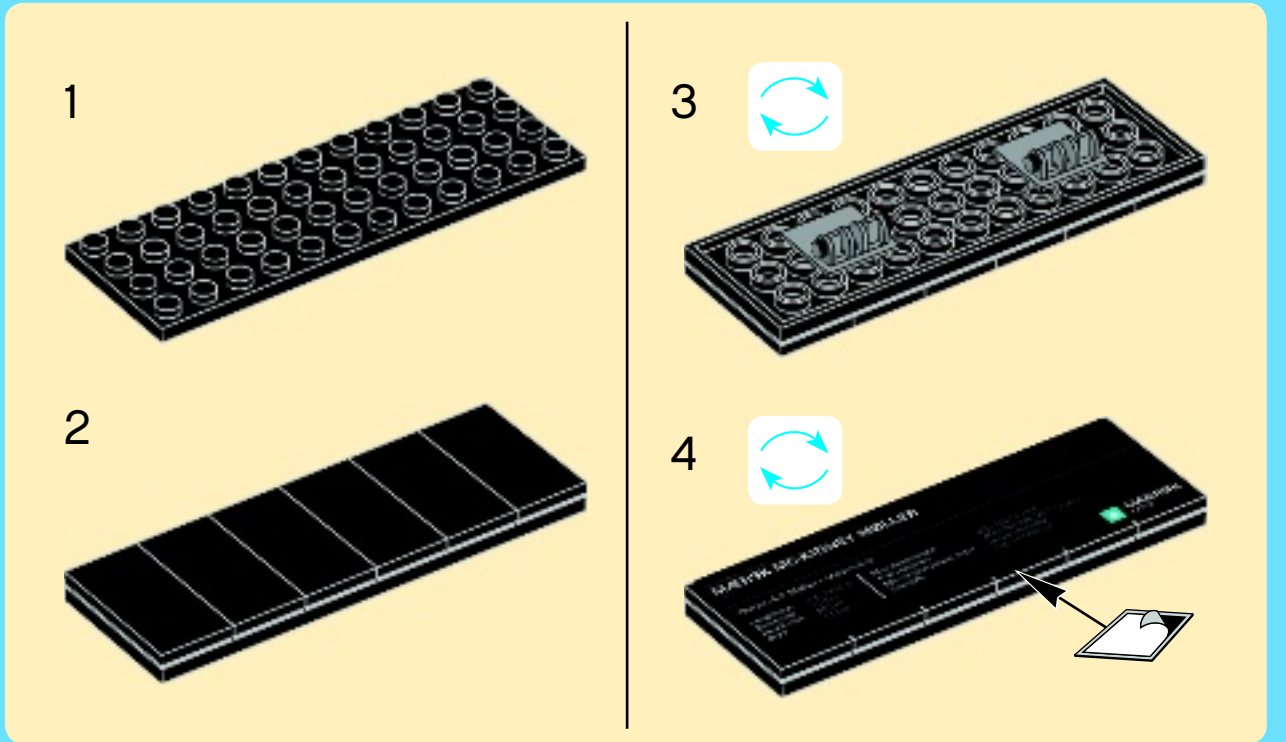

86



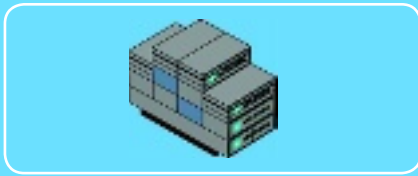
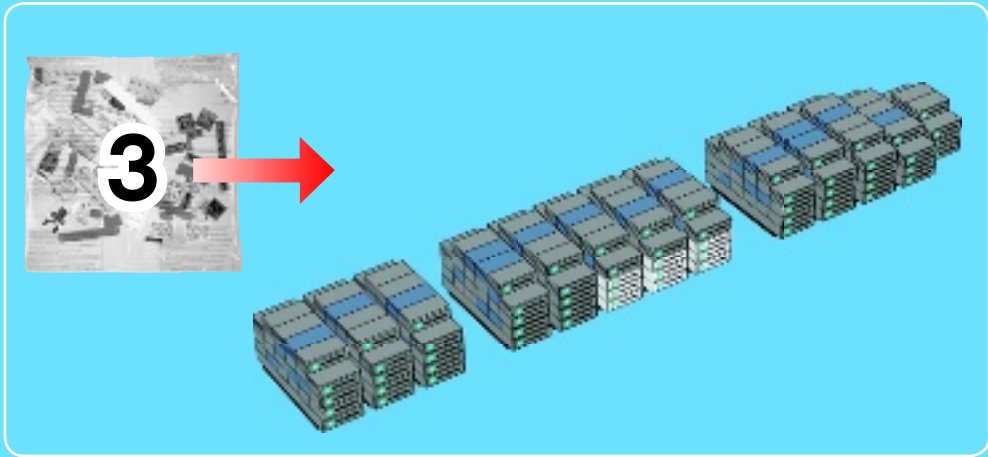

1

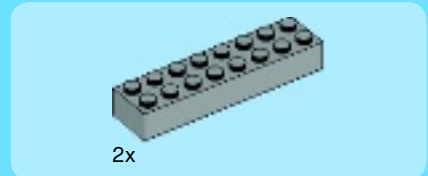

2

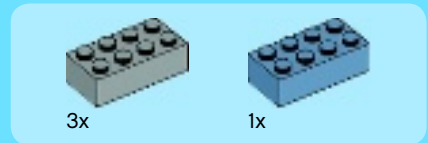
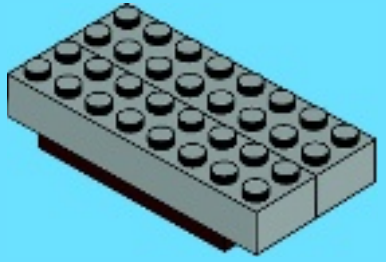

3

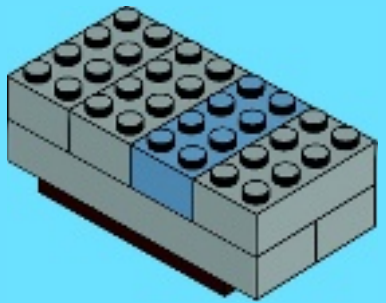

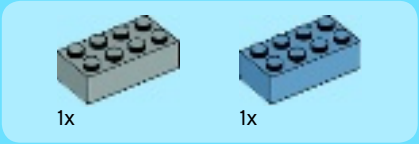

4

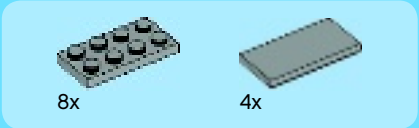
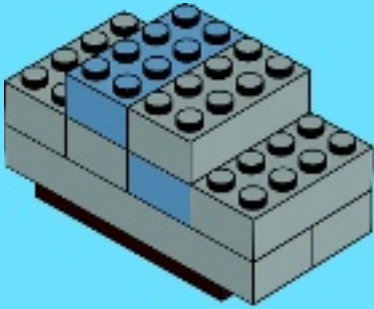

5

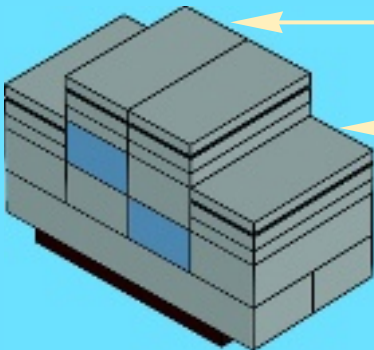
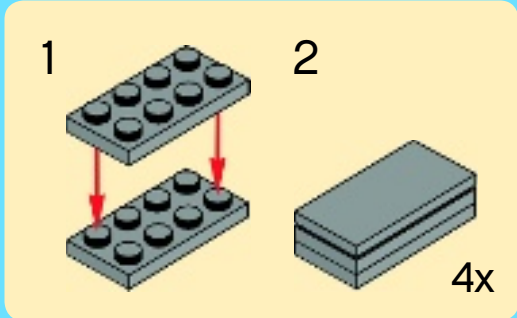

6

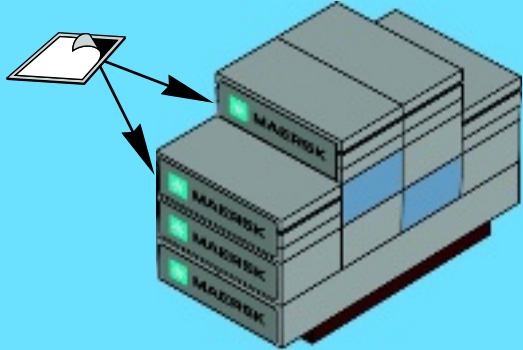

7

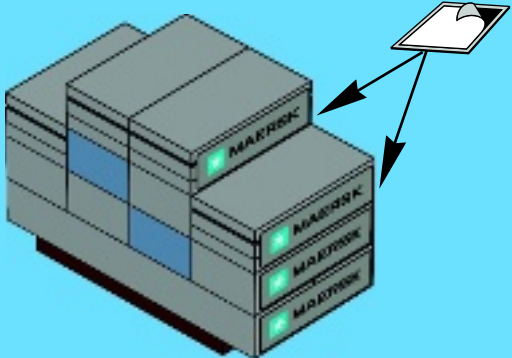

87



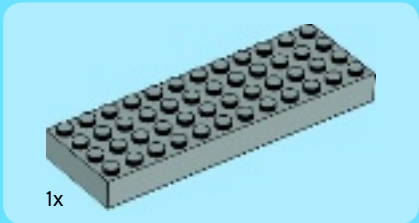
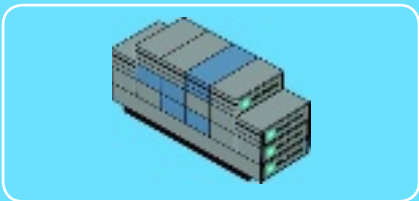

1x

1

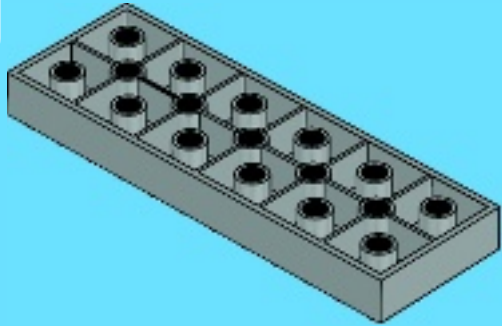

2x

2

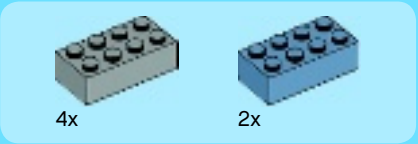
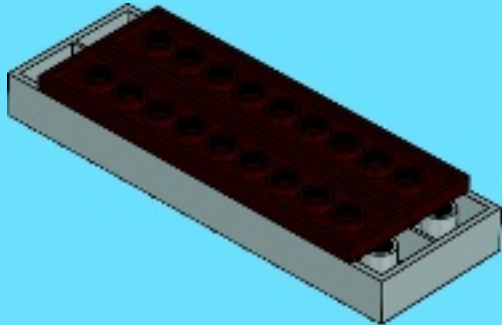

4x

2x

3

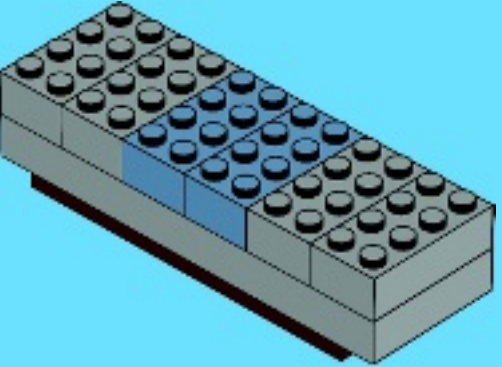

2x

2x

4

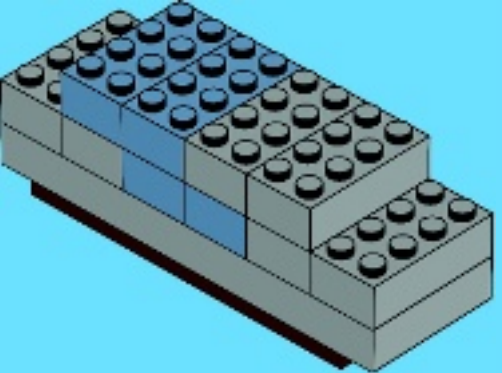

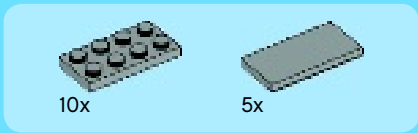

5

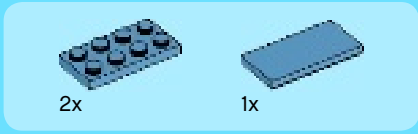
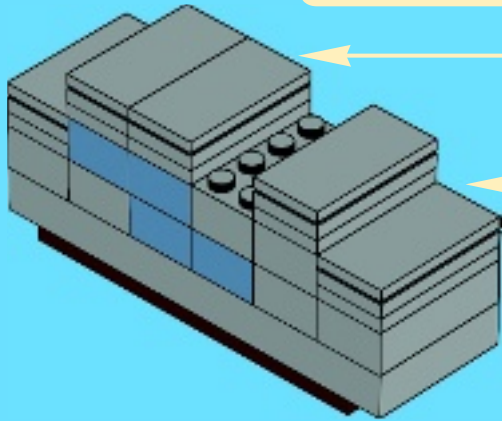
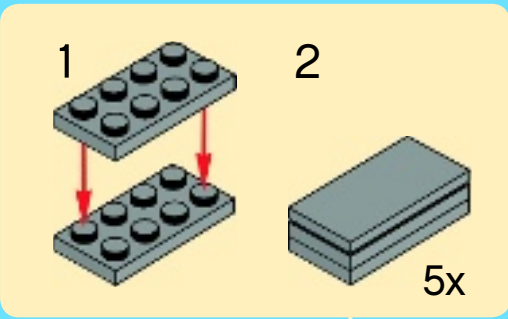

6

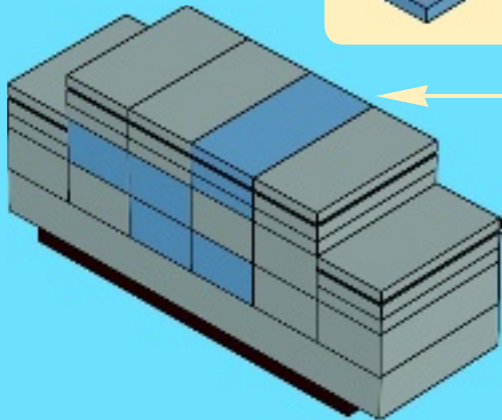
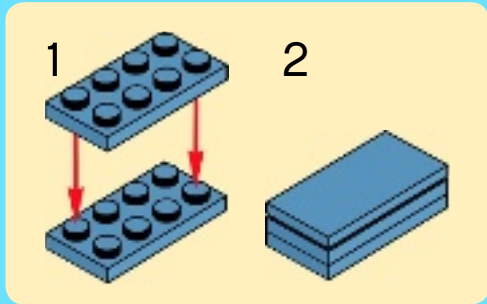

7

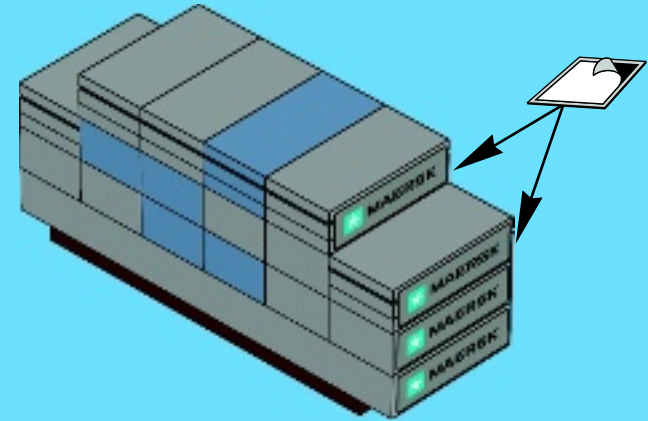

8

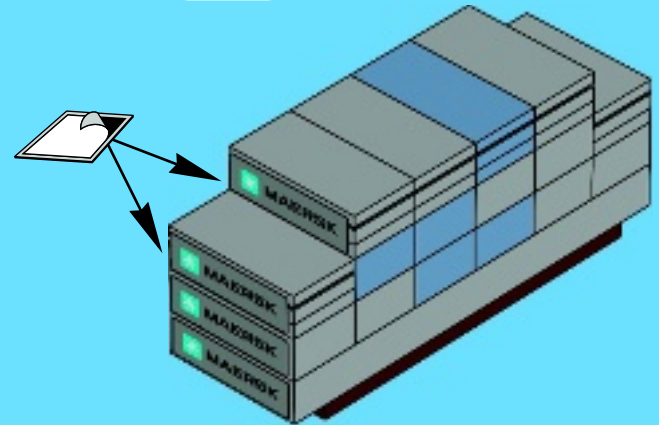

88

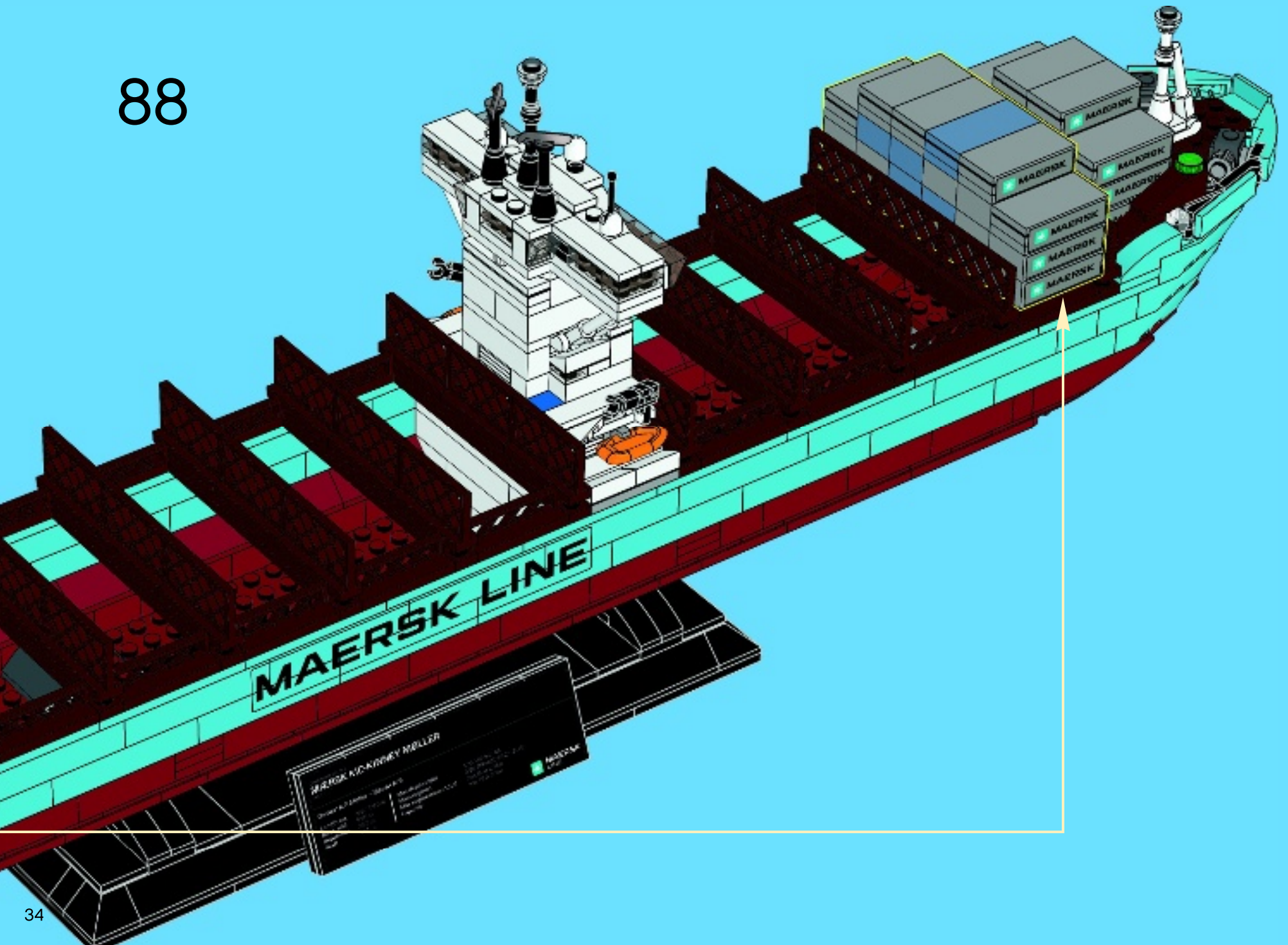

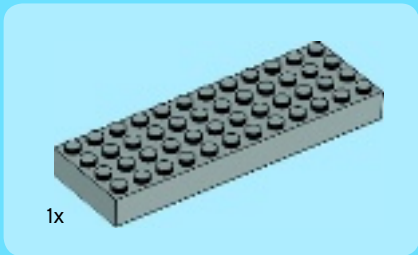
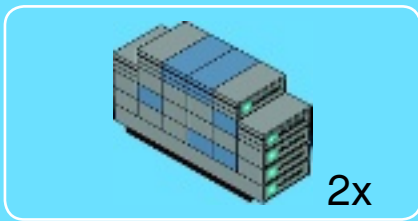

1

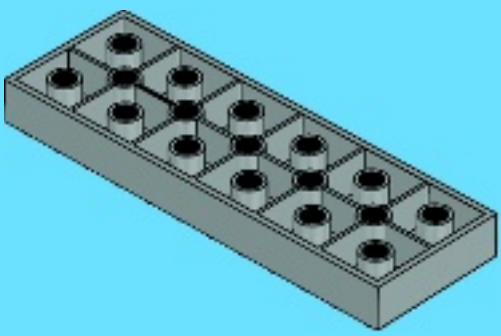

2

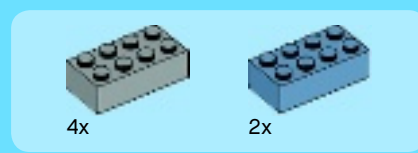
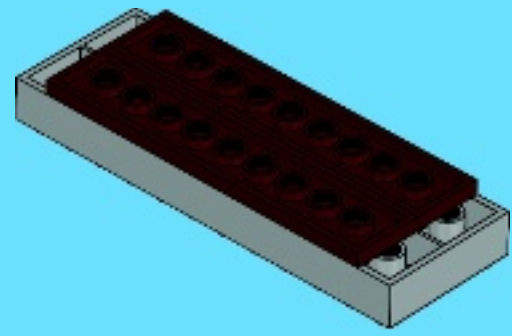

3

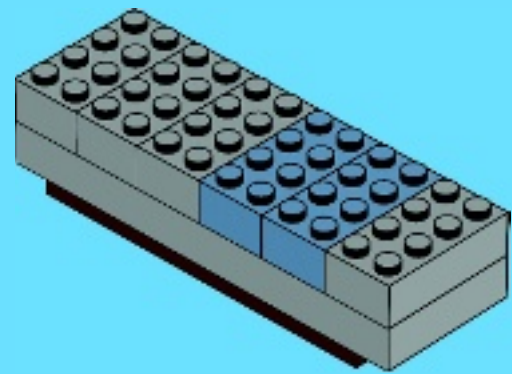

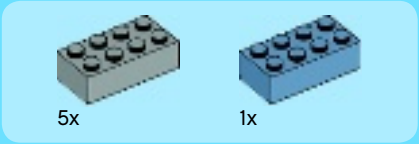

4

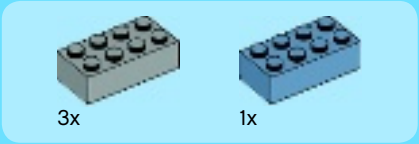
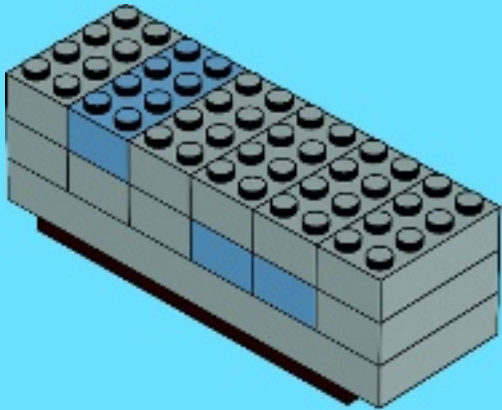

5

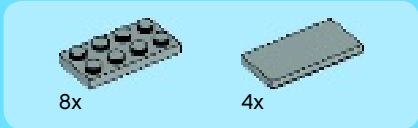
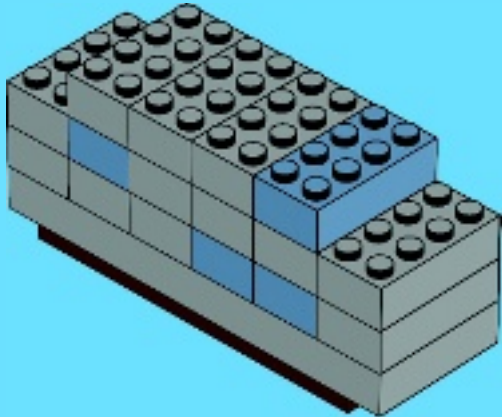

6

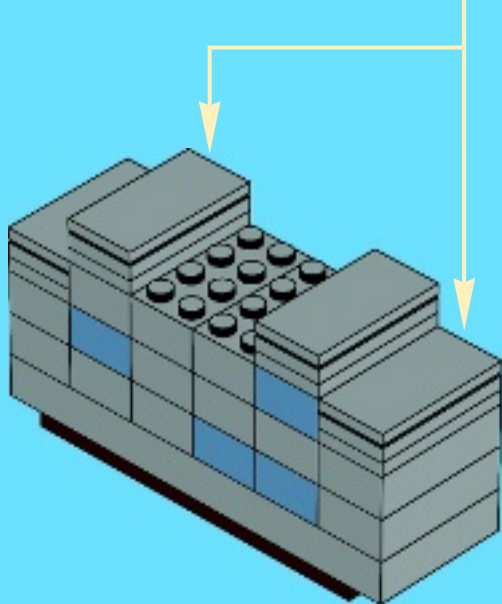
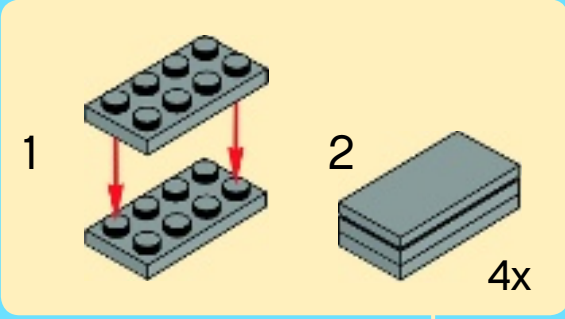

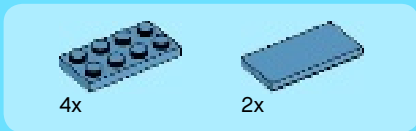

7

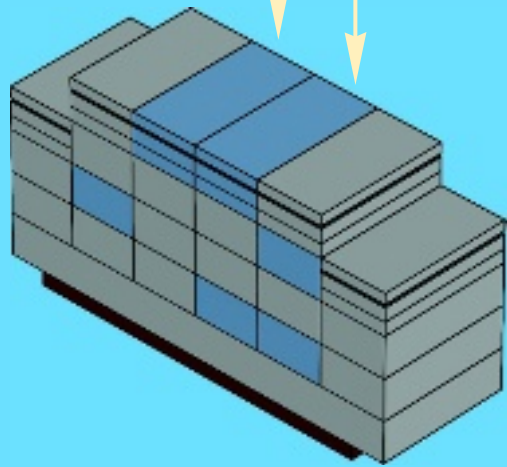
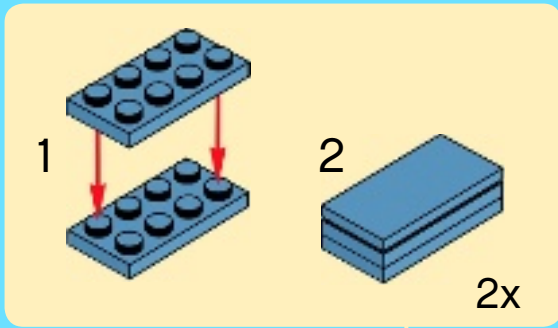

8

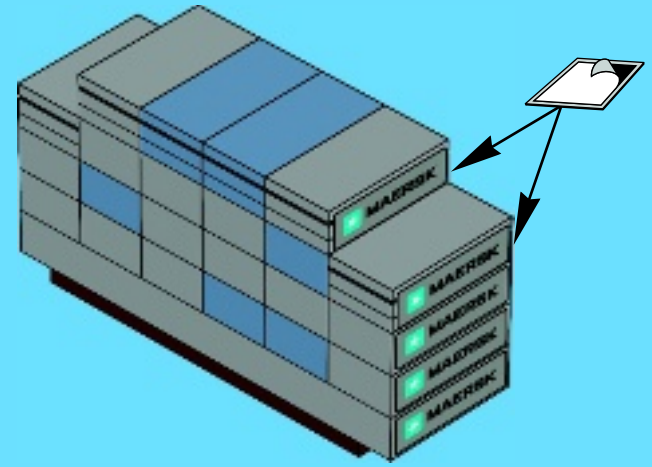

9

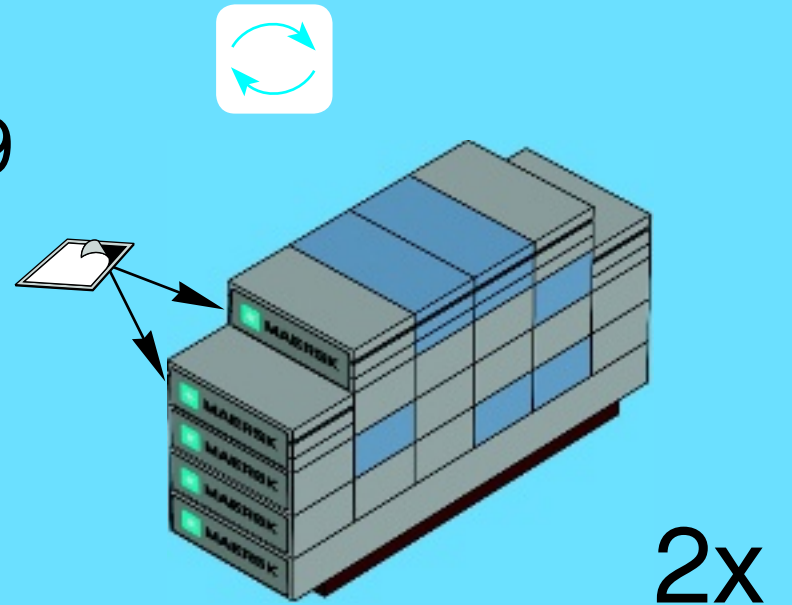

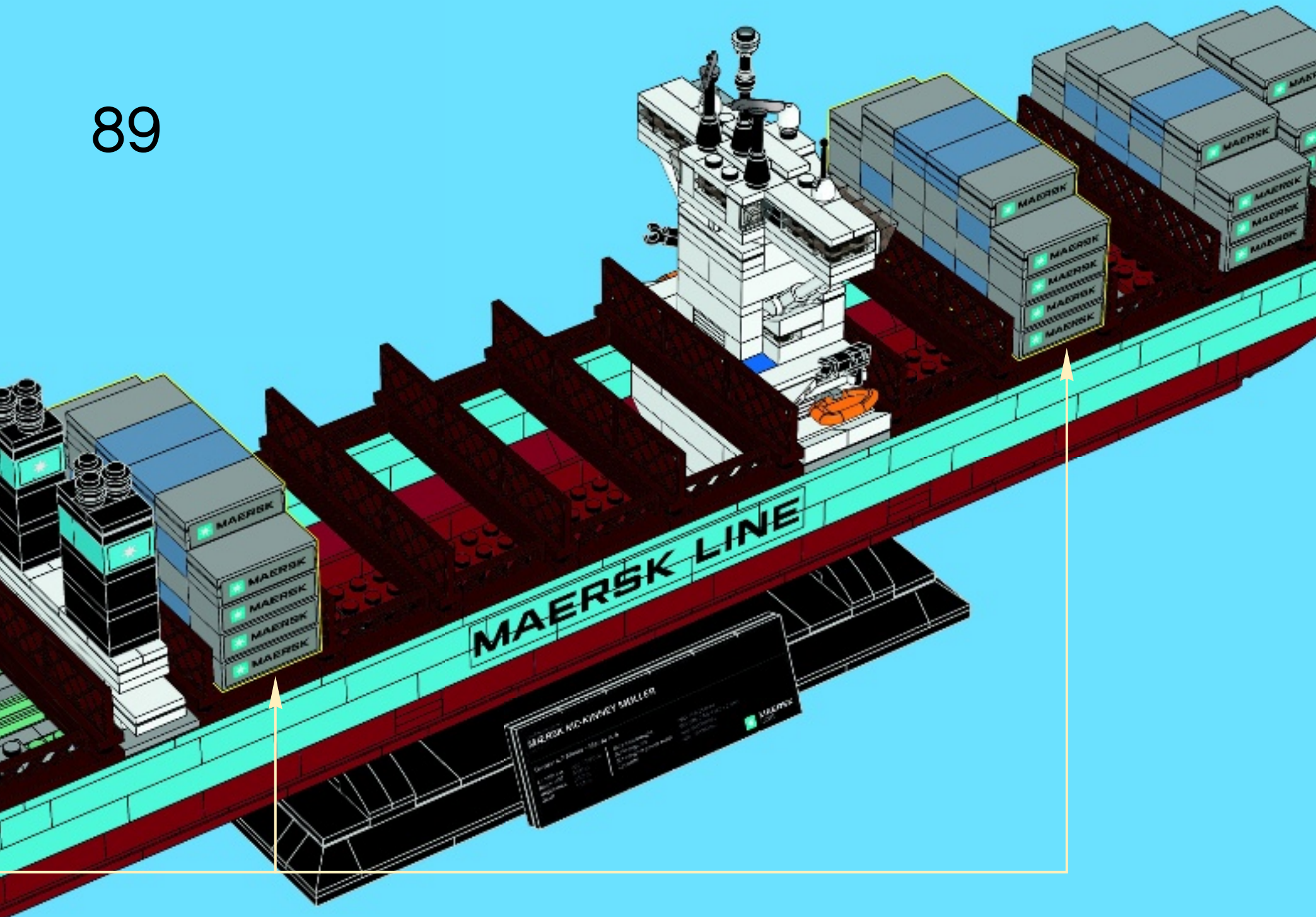

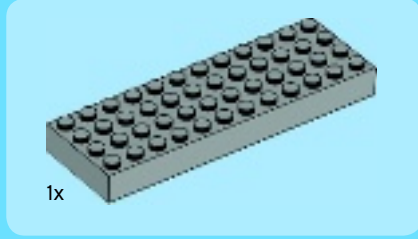
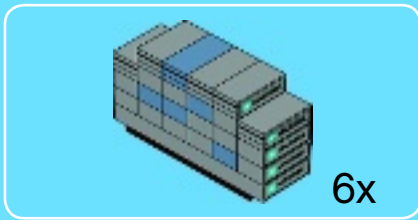

1

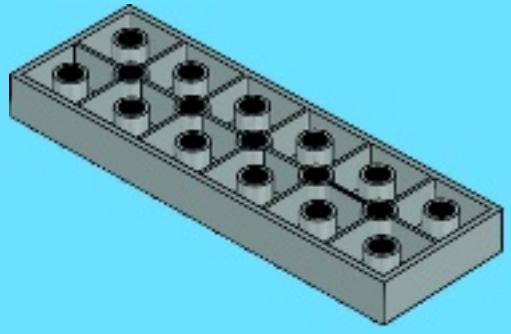

2

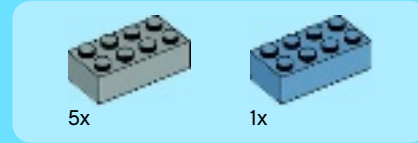
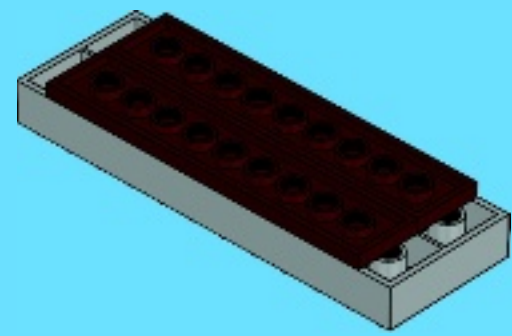

3

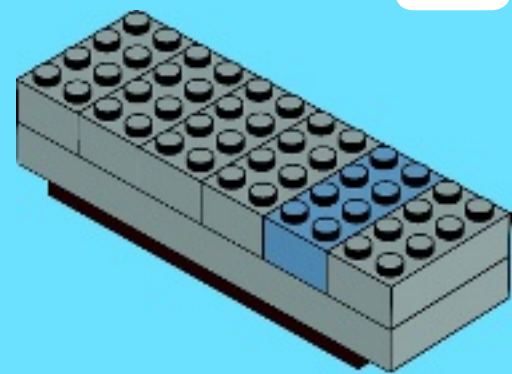

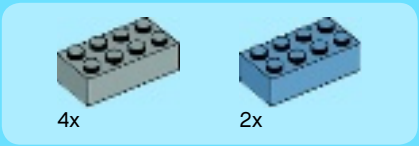

4

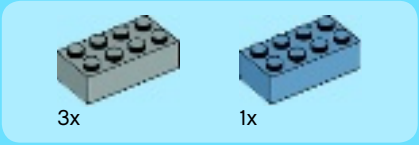
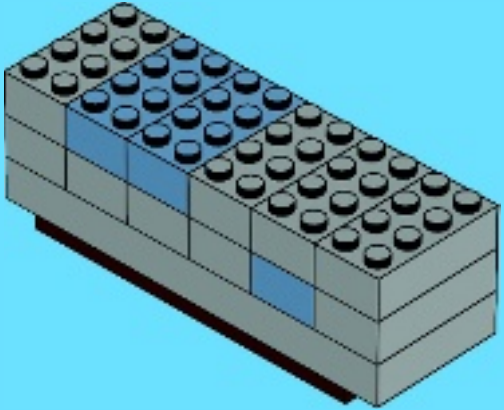

5

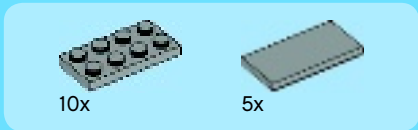
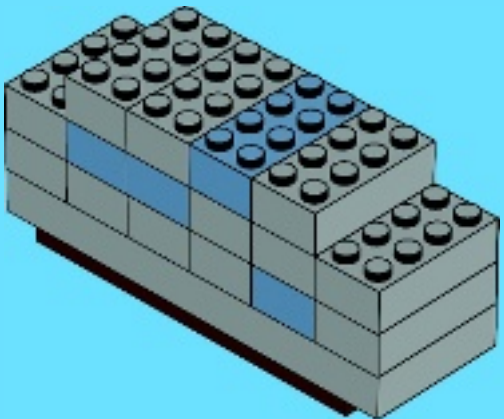

6

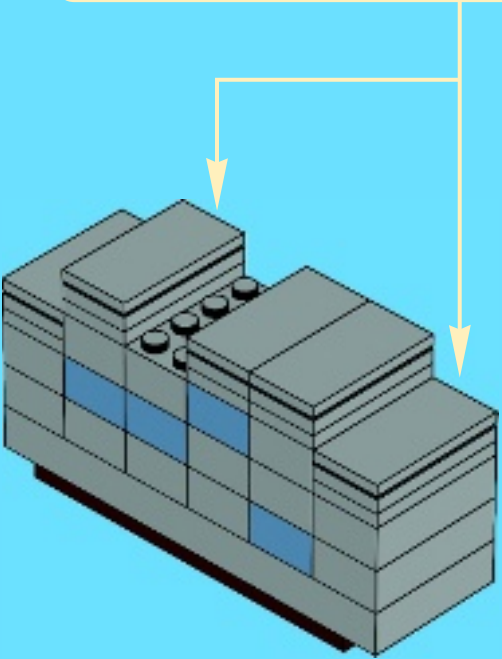
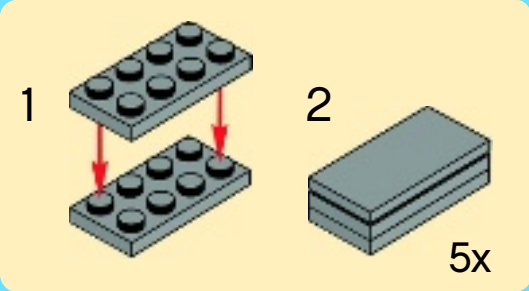

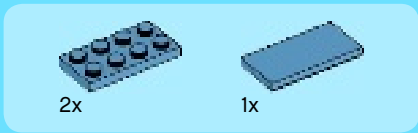

7

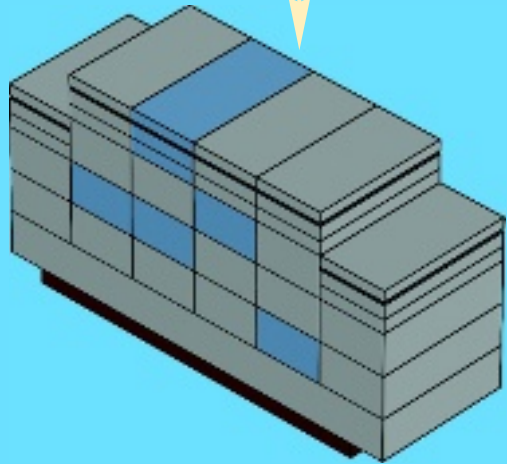
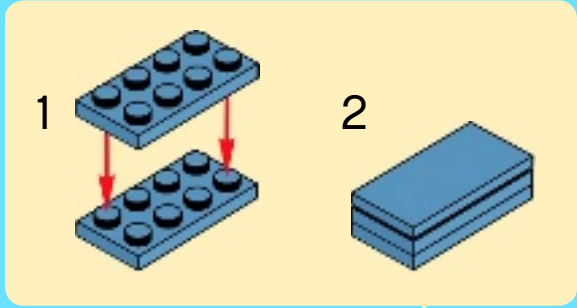

8

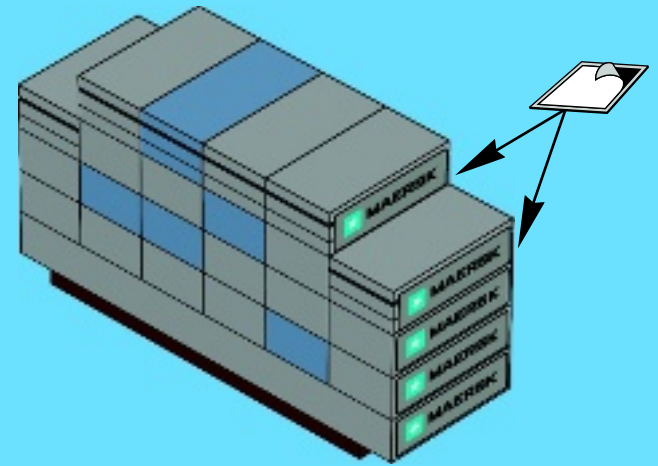

9

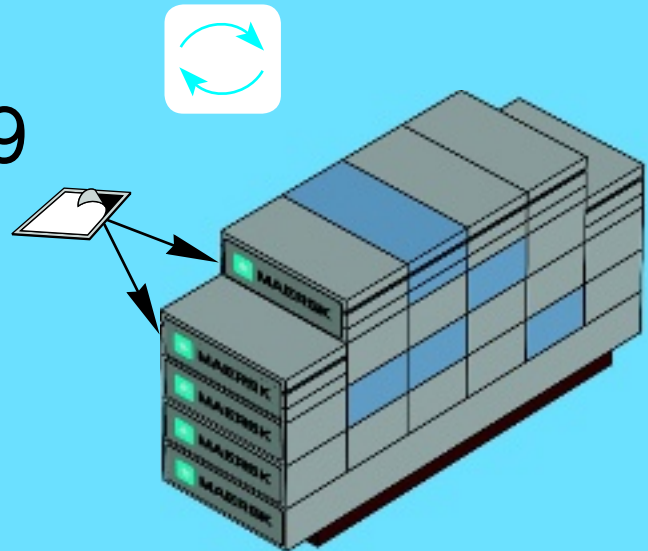

90

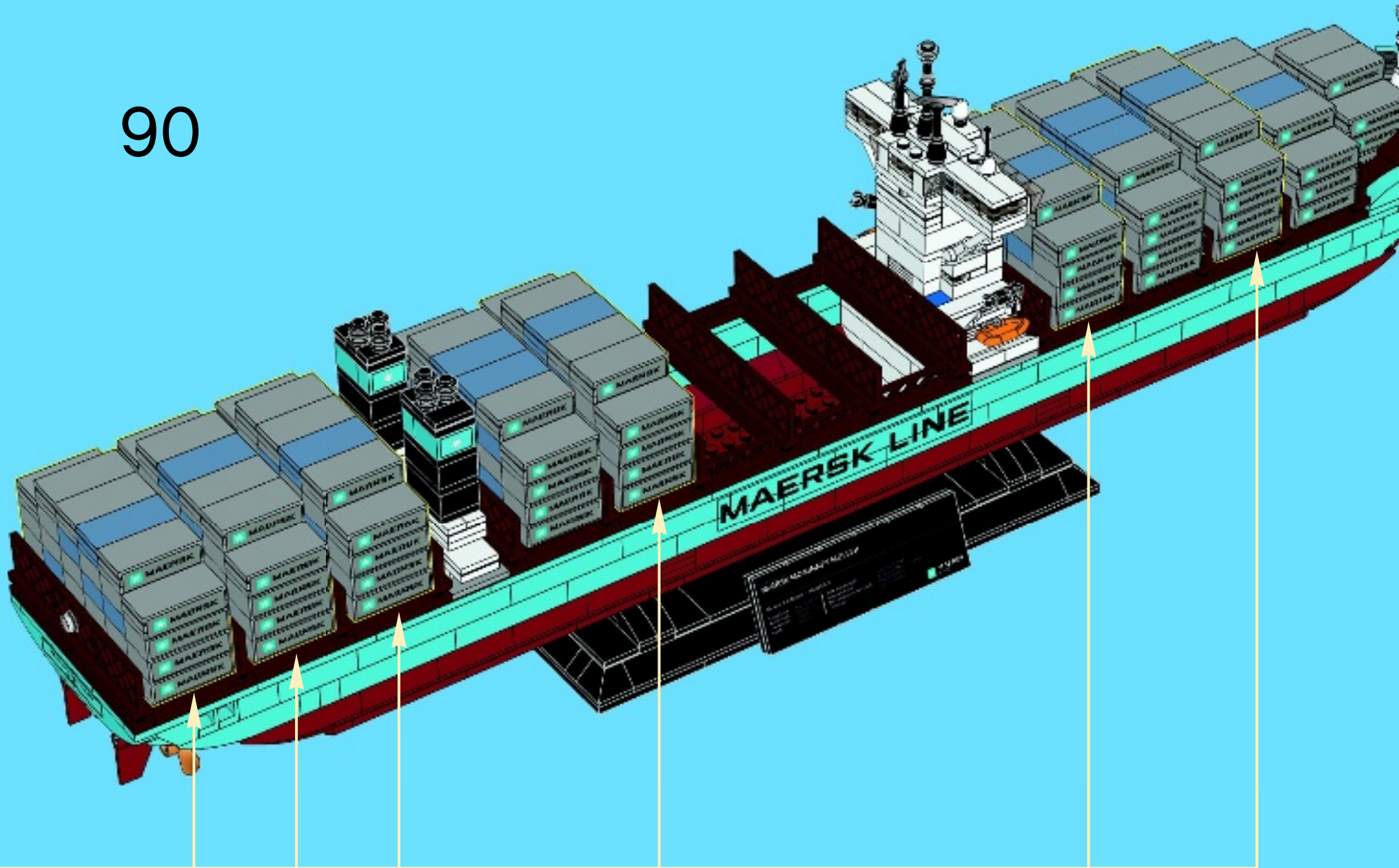

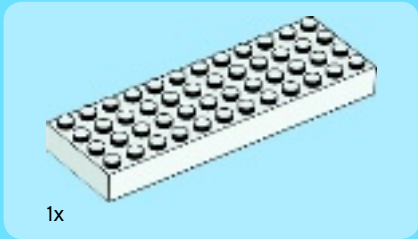
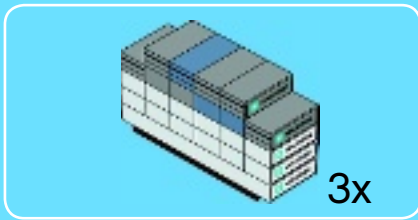

1

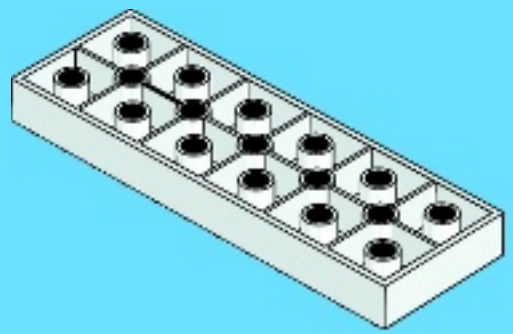

2

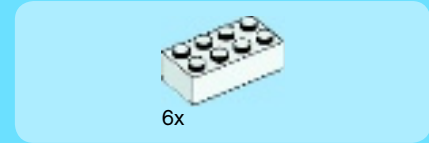
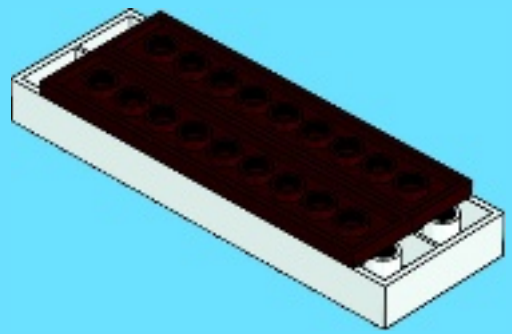

3

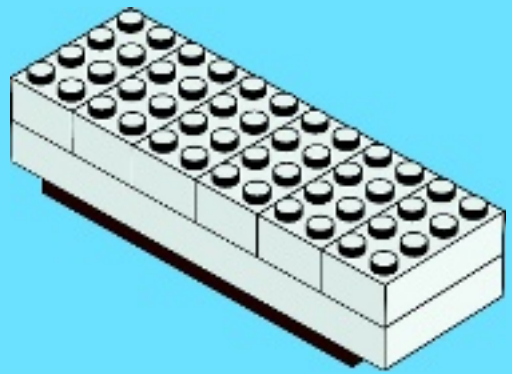



6x

4

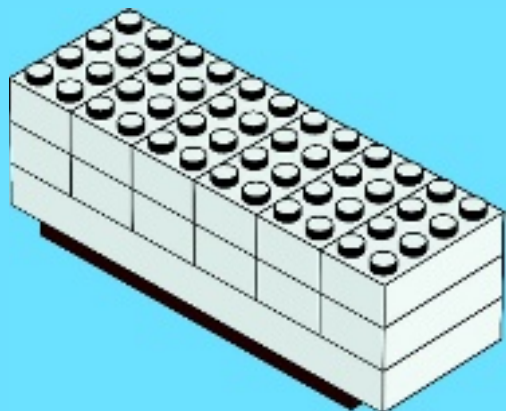

2x

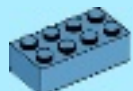

2x

5

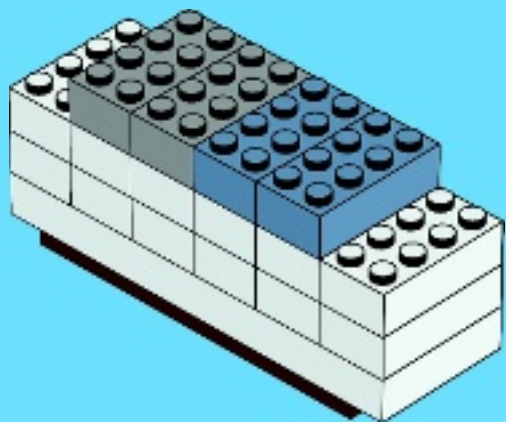

10x



5x

6

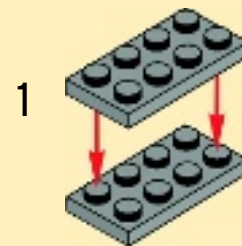

1

2

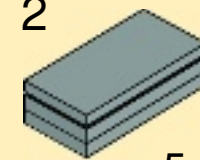

5x

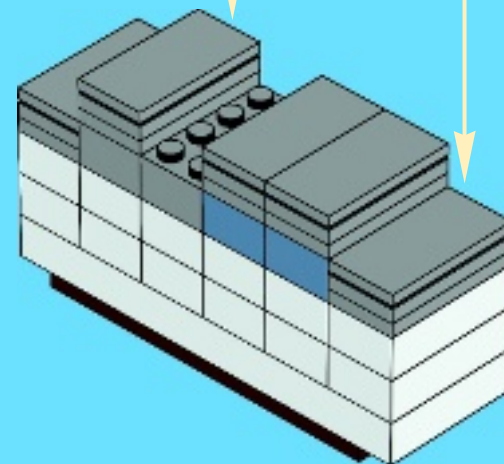

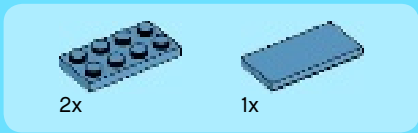

7

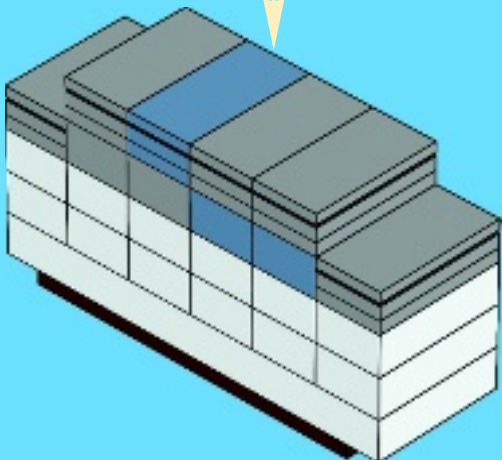
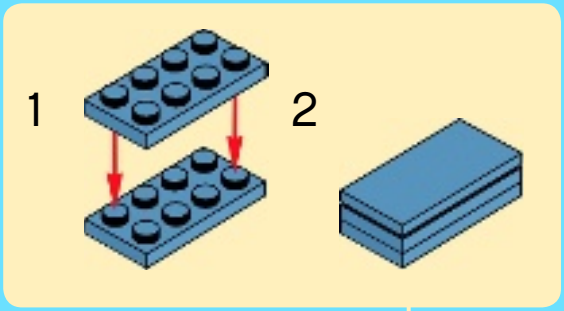

8

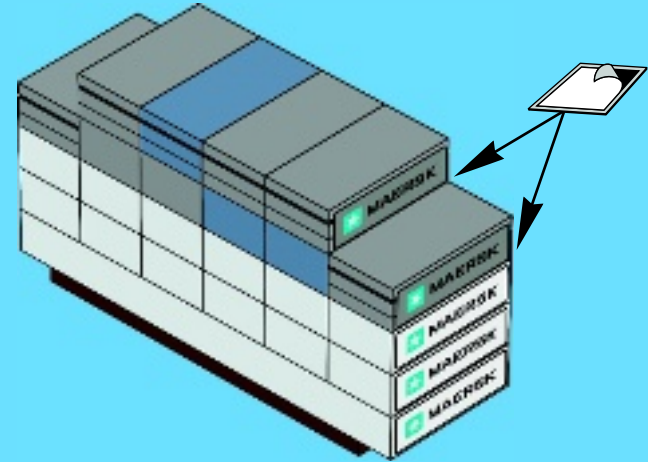

9

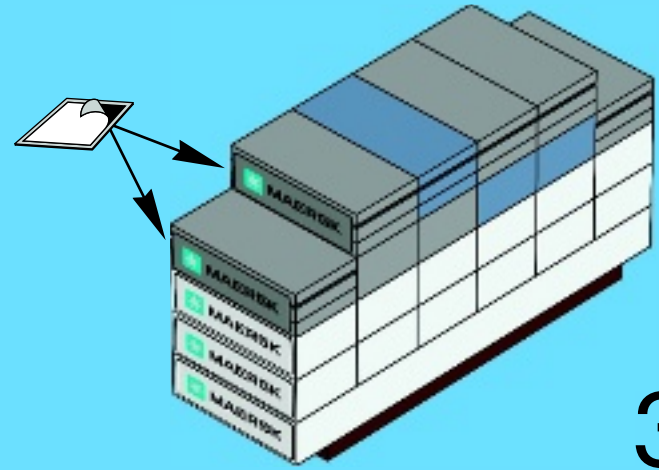

3x

91

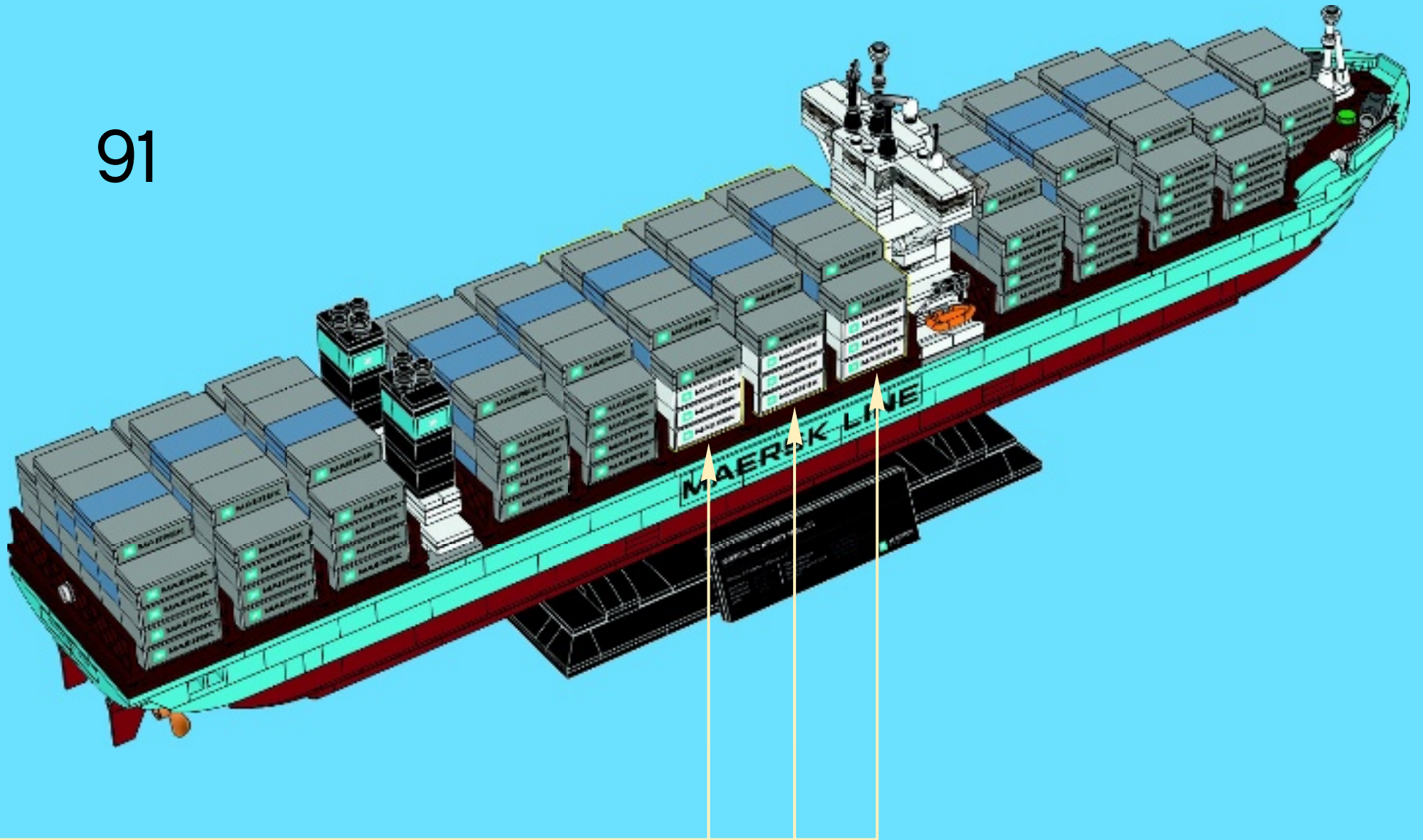



4x
287701

2x
362201

9x
301001

44x
300101

8x
300901

4x
407001

1x
4518400

6x
4547489

3x
307001

6x
302401

23x
6051511

7x
306901

8x
302301

5x
306801

2x
243201

5x
4515364

48

5x
302201

2x
4613256

2x
4282737

1x
4179875

1x
4179874

9x
243101

9x
371001

9x
302001

2x
366601

2x
379501

1x
447701

4x
383201

3x
6052797

4x
4249506

2x
73737

6x
6056663

1x
4623199

1x
6040333

5x
6052824

6x
300226

6x
6052796

3x
4529236

8x
4121966

4x
4189064

3x
303726

8x
4251161

2x
379426

6x
306926

3x
306926

2x
4517925

2x
302326

8x
302126

14x
4560182

5x
366626

2x
373826

5x
4163334

5x
303326

1x
302926

1x
4603646

1x
6048855

2x
4535739

2x
4515368

8x
370926

14x
614126

27x
4278359

3x
4653208

1x
4598897

2x
6052829

2x
6015891

4x
393726

2x
4124096

4x
4109810

8x
4121715

6x
4512363

3x
370526

1x
4631857

2x
626440

3x
3005740

2x
4594686

1x
4646864

1x
4646860

14x
6001197

14x
4244368

44x
6052830

14x
6052832

28x
6052827

16x
6009656

4x
6057579

10x
6052779

24x
6057585

12x
4211525

4x
4541379

4x
6052777

5x
6057588

1x
6028338

3x
6052785

10x
4531415

4x
4590811

58x
6052917

3x
4609925

6x
6052920

18x
4541380

16x
6052914

2x
6052768

2x
6052772

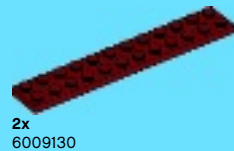

1x
4541544

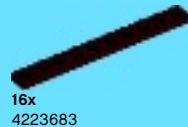
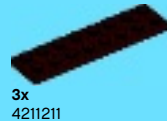

3x
6052822

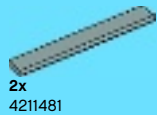
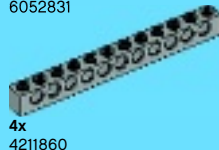
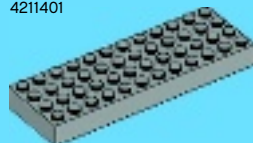
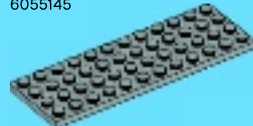
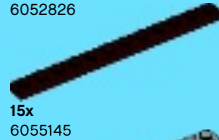
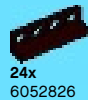

10x
4568637



2x
4211480



15x
6004945

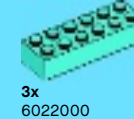

2x
4624705



Customer Service
Kundenservice
Service Consommateurs
Servicio Al Consumidor
LEGO.com/service or dial





Join the LEGO® VIP Loyalty Program!

Nehmen Sie am LEGO® VIP-Programm teil!

Rejoignez le programme de fidélité LEGO® VIP !

Earn points towards valuable rewards every time you shop!



Get 1 VIP Point for every Dollar, Pound or Euro spent!*

*For other exchange rates, please see VIP.LEGO.com



For every 100 Points you earn, enjoy a \$5 / £5 / 5€ reward!

Sammeln Sie bei jedem Einkauf Punkte für wertvolle Prämien!



Erhalten Sie 1 VIP-Punkt für jeden Euro, Pfund oder Dollar, den Sie ausgeben!*

*Den Umrechnungsfaktor für andere Währungen erhalten Sie auf VIP.LEGO.com



Für 100 VIP-Punkte erhalten Sie eine Prämie von 5€ / £5 / \$5!

Gagnez des points à chaque achat et obtenez de formidables récompenses !



Gagnez 1 point VIP pour chaque euro, livre ou dollar dépensé !*

*Pour d'autres taux de change, veuillez visiter VIP.LEGO.com



Par tranche de 100 points gagnés, bénéficiez d'une récompense de 5 € / 5 £ / 5 \$!



Redeem your rewards in LEGO Stores and shop.LEGO.com.

Lösen Sie Ihre Prämien in den LEGO Stores und auf LEGO.com/shop ein.

Utilisez vos récompenses dans les LEGO Stores et sur LEGO.com/shop.



- Enjoy early access to new LEGO products and promotions!
- Access special LEGO sets and goodies not available for anyone else!

Plus much, much more!

- Kaufen Sie neue exklusive LEGO Produkte, noch vor dem eigentlichen Verkaufsstart!
- Erhalten Sie Zugang zu besonderen LEGO Sets und Vorteilen, die es nur für LEGO VIPs gibt!

Und vieles mehr!

- Bénéficiez d'un accès en avant-première à des nouveautés et promotions LEGO !
- Accédez à des cadeaux et ensembles LEGO spéciaux réservés aux membres !

Et bien d'autres choses encore !

Visit VIP.LEGO.com for more information!

Besuchen Sie VIP.LEGO.com für weitere Informationen!

Rendez-vous sur VIP.LEGO.com pour en savoir plus !





CREATOR

10224

10232

10243



EXPERT

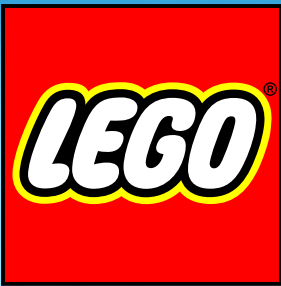

CREATOR

LEGO.com/creator

YOUR OPINION COUNTS! VOTRE OPINION NOUS INTÉRESSE !

Answer a few questions about your new LEGO® product and you could **win** a prize!
Please visit:

LEGO.com/productfeedback

No purchase necessary. Open to all residents where not prohibited.



DEINE MEINUNG ZÄHLT!
Beantworte einige Fragen über unser neues LEGO® Produkt und gewinne mit etwas Glück einen Preis!
Besuche uns auf:
LEGO.com/productfeedback

Die Teilnahme ist nicht an einen Einkauf gebunden.
Teilnahme in allen nicht ausgeschlossenen Ländern möglich.

VOTRE OPINION NOUS INTÉRESSE !
Répondez à quelques questions sur notre nouveau produit LEGO® et vous gagnerez peut-être un prix !
Rendez-vous sur :
LEGO.com/productfeedback

Sans obligation d'achat.
Ouvert à tous les résidents des pays autorisés.

GEEF JE MENING!
Beantwoord een paar vragen over je nieuwe LEGO® product en maak kans op een prijs!
Ga naar:
LEGO.com/productfeedback

Geen koopverplichting.
Deelname toegestaan waar geen enquêteverbod geldt.

みなさまのご意見をお聞かせください！
レゴ®新製品について、いくつかの質問にお答えください。お答え頂いた方には抽選でプレゼントをお渡しします。
以下のサイトをご覧ください：
LEGO.com/productfeedback

お買い上げ頂く必要はありません。
どなたでもご利用いただけます。
(法律で禁止されている国を除く)

EXPERT