



LEGENDS OF

CHIMA

TM

70133



1



2



3



4



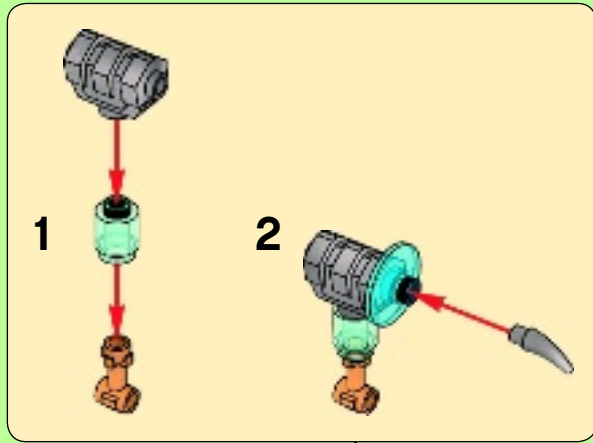
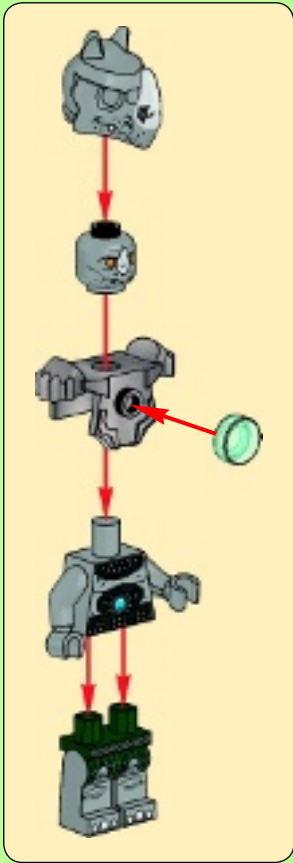

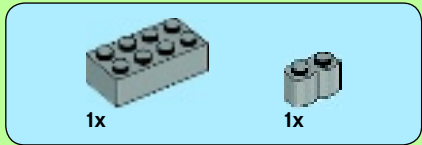

1

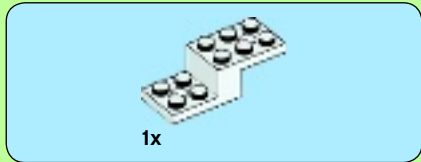
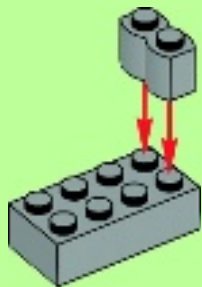

2

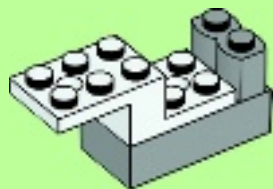



3



4

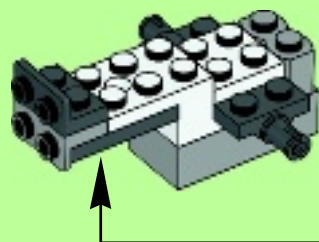
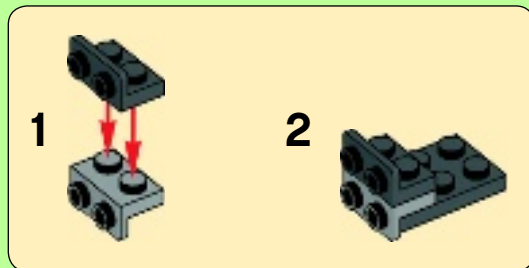



1x



2x

5

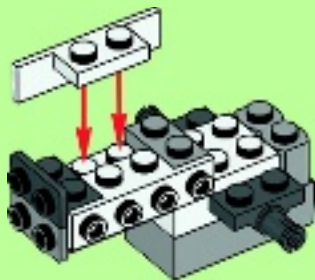

6



1x



2x



1x

6





1x

7

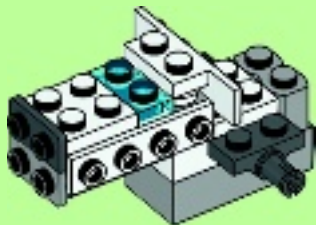

1x



2x

8



1



2





9

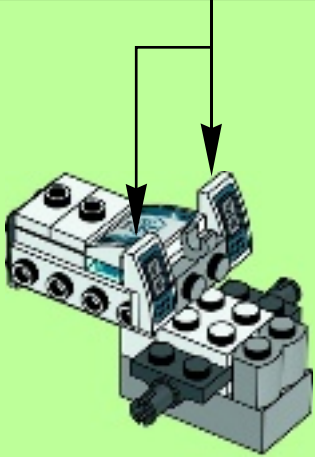
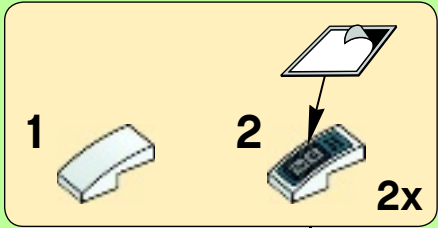



1x



1x

10



1x



1x

11



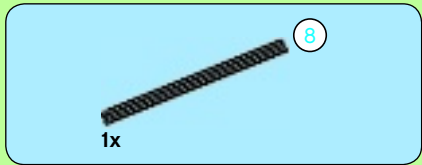

1



10

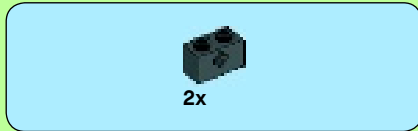
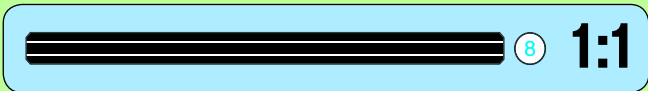

2

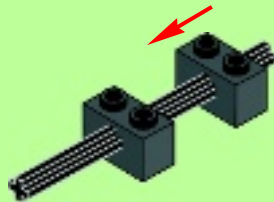

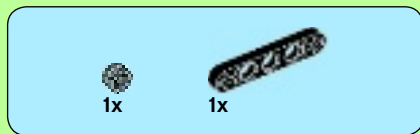

3

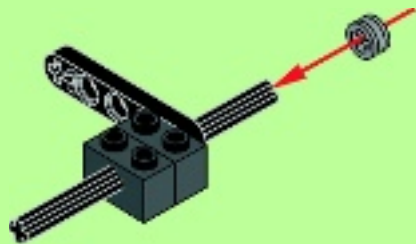

4

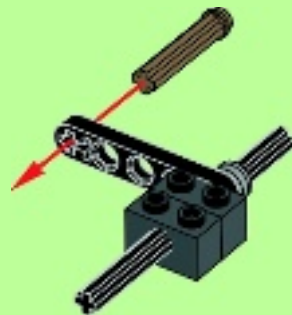



5

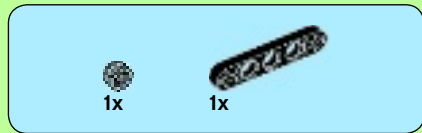
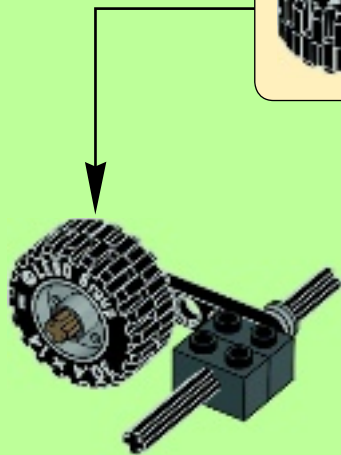
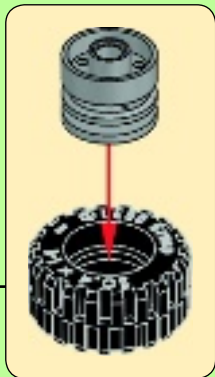

6



7

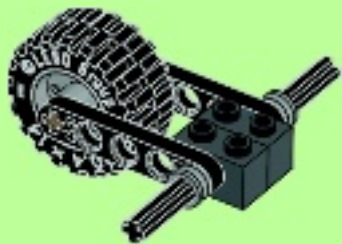

12

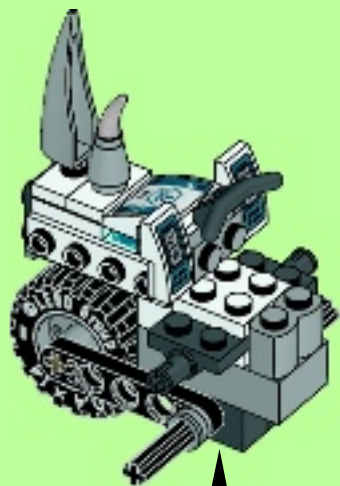



2x

13

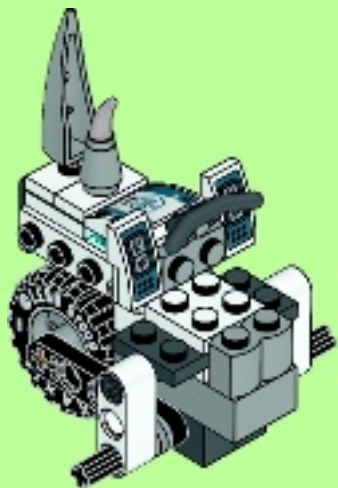

2x

14

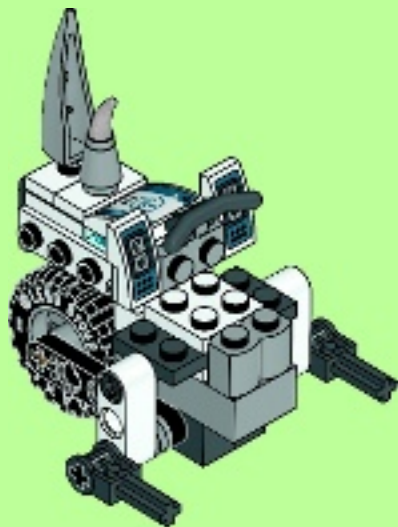



1x



1x



1x

15

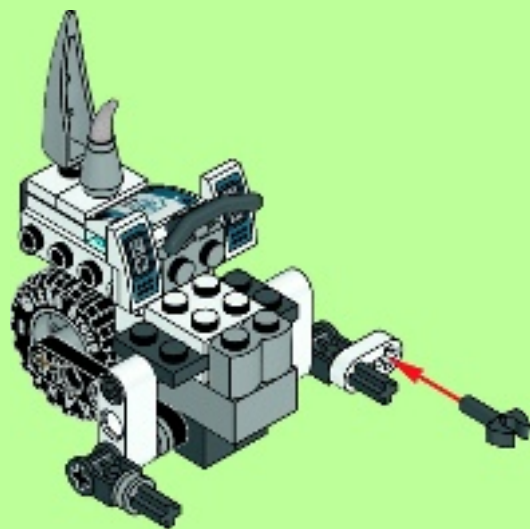

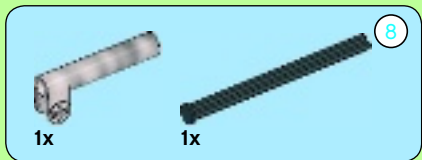

1



16



2

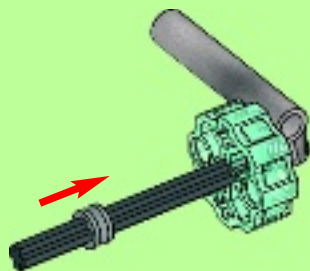



3

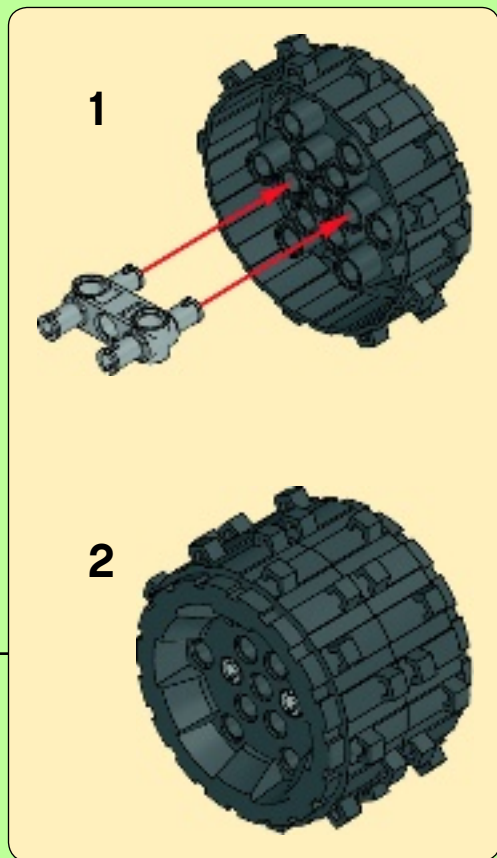
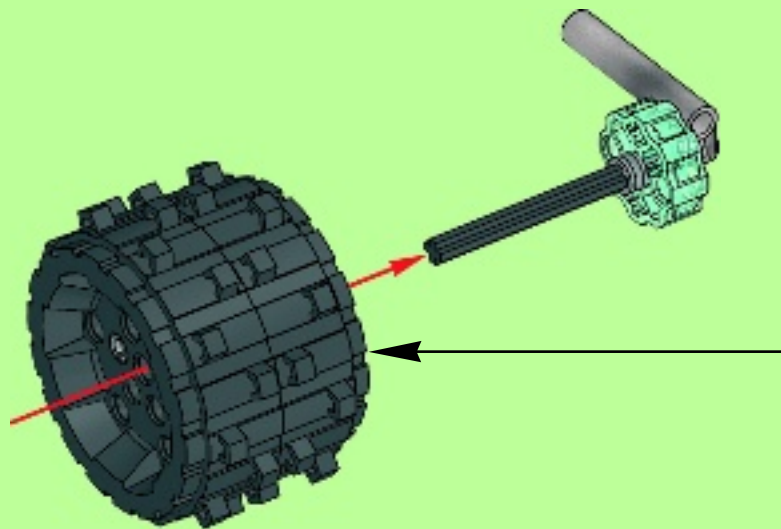



1x

4

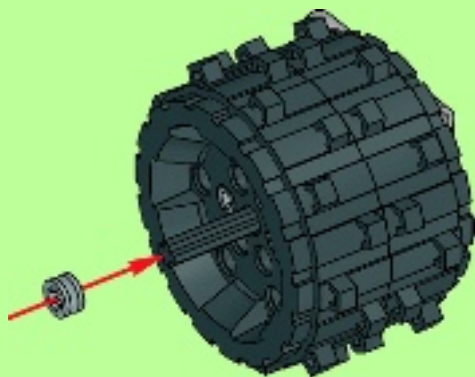

1x

5

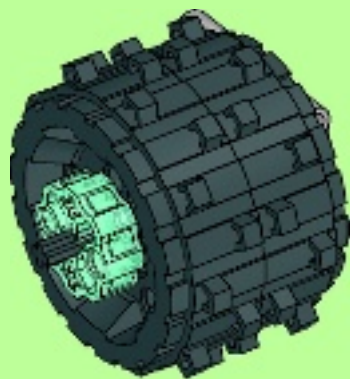

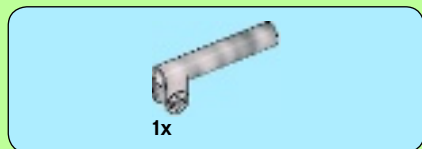

6

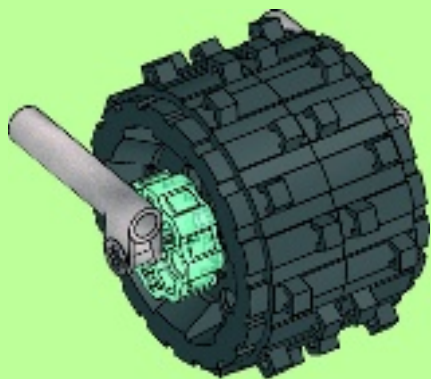

16

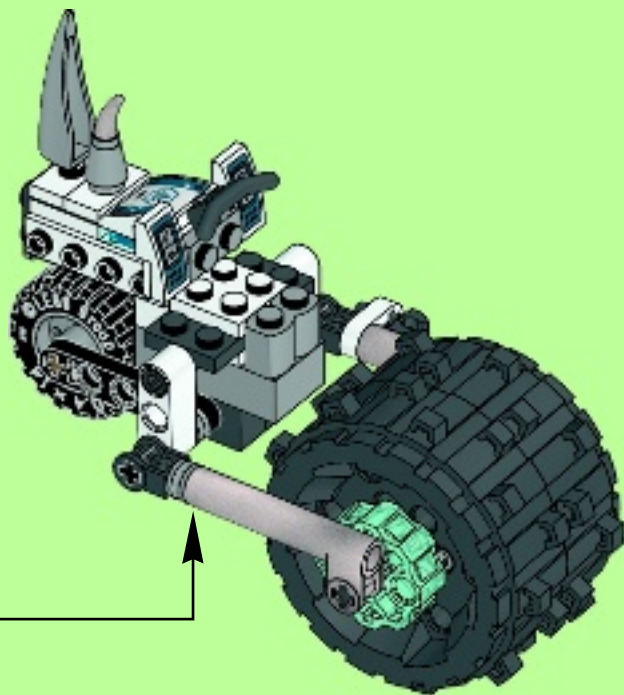



1x



1x

17

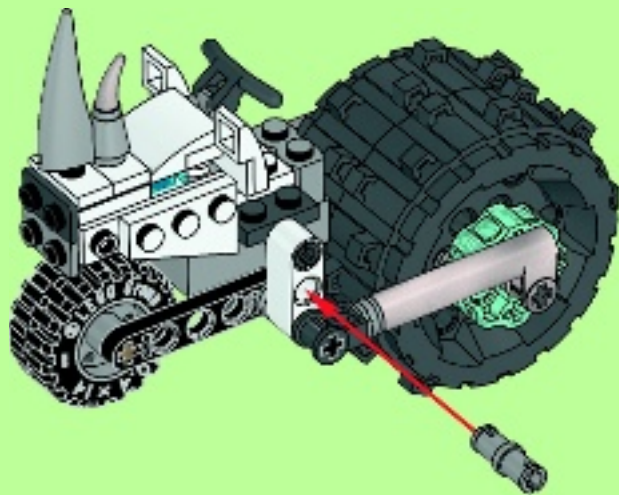
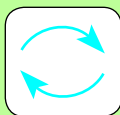



1x



18

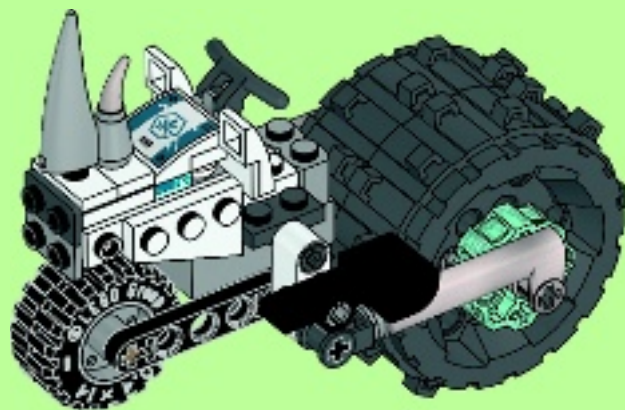



19

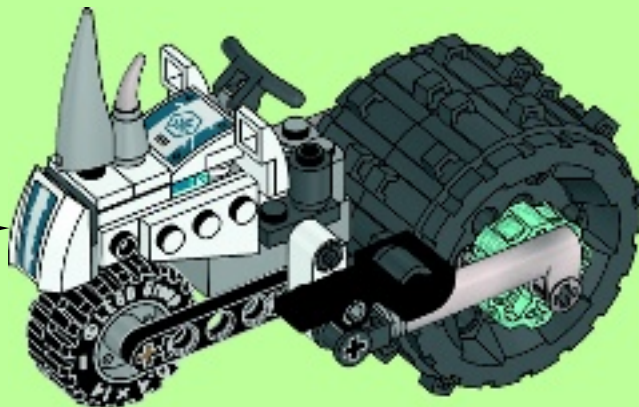
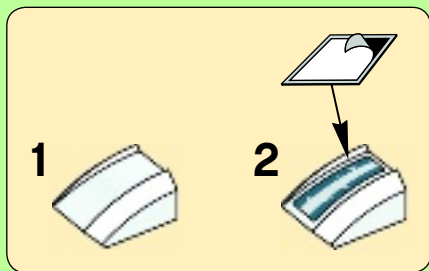



1x



1x

20

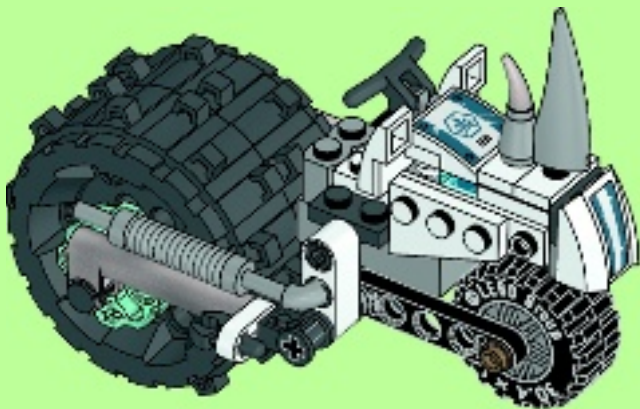

21

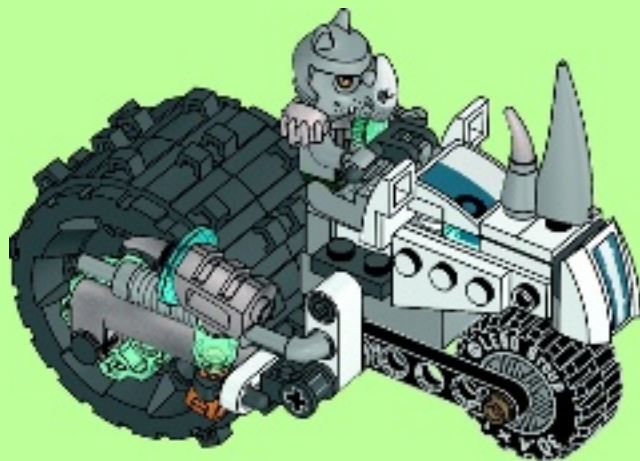



LEGENDS OF

CHIMA

TM

70133



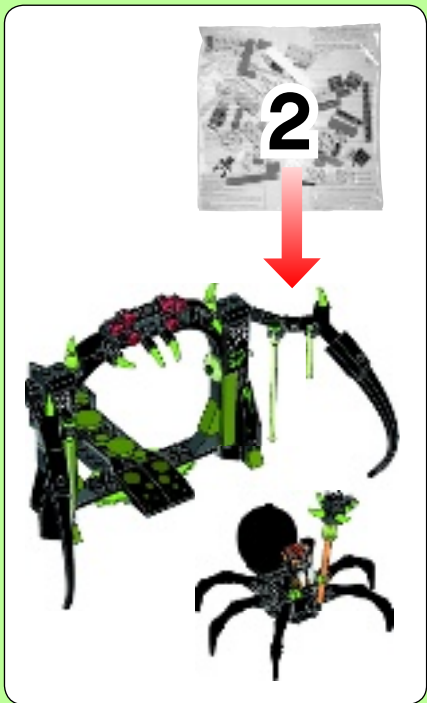

1

2

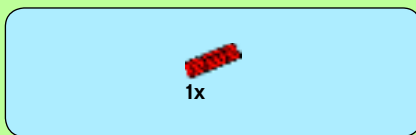

2



3



4





5



6

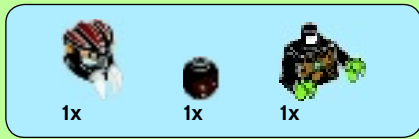

7

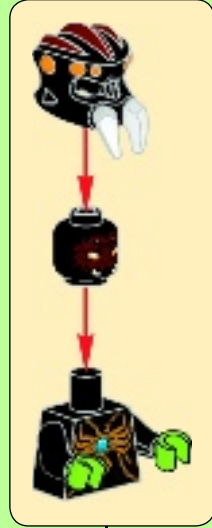

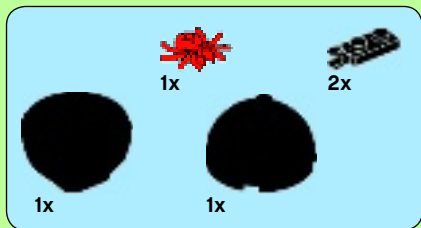

8

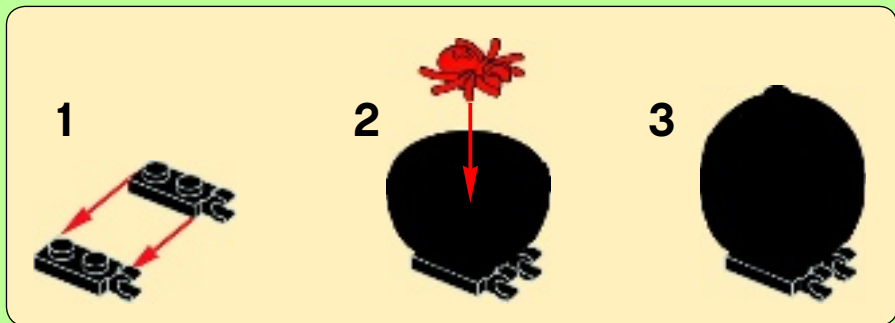

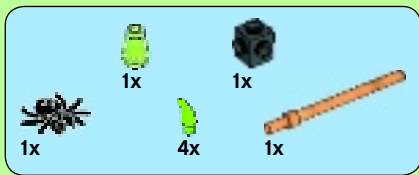

9

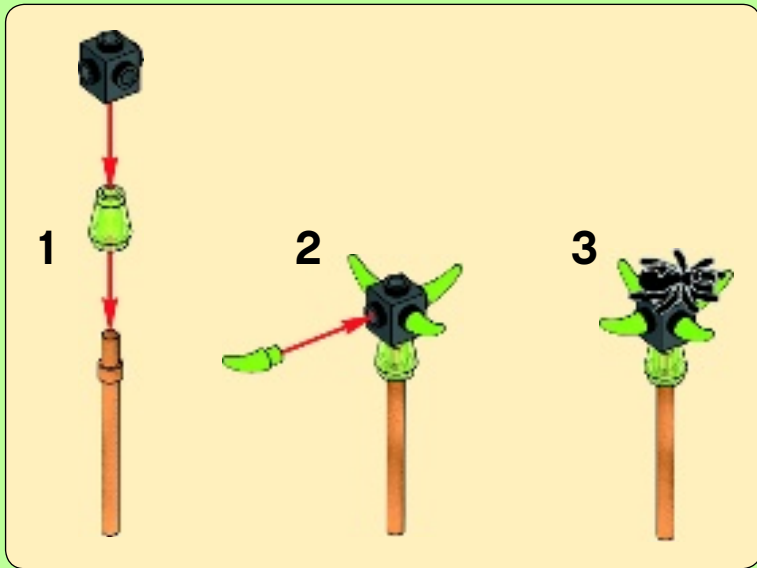

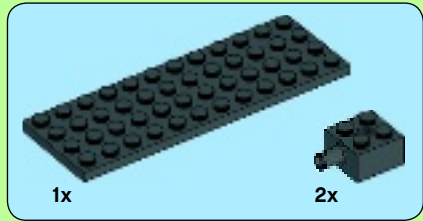

1

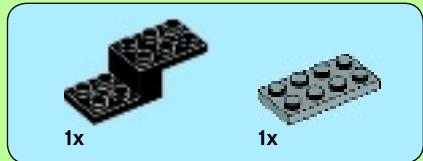
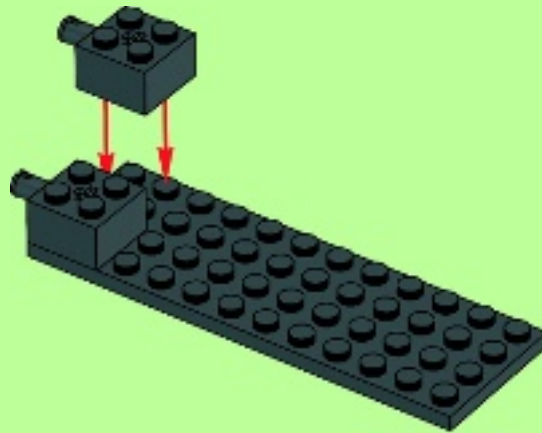

2

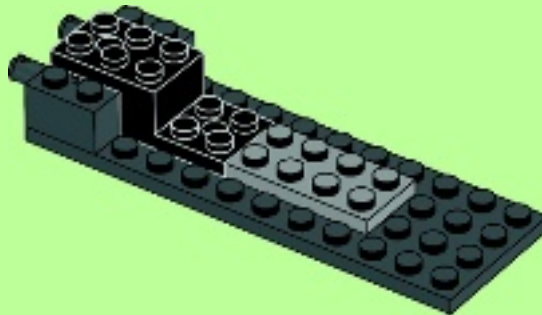

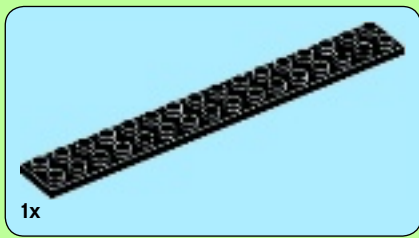

3

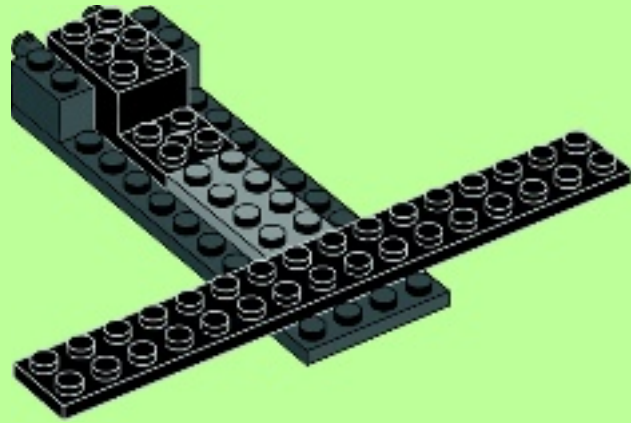

4

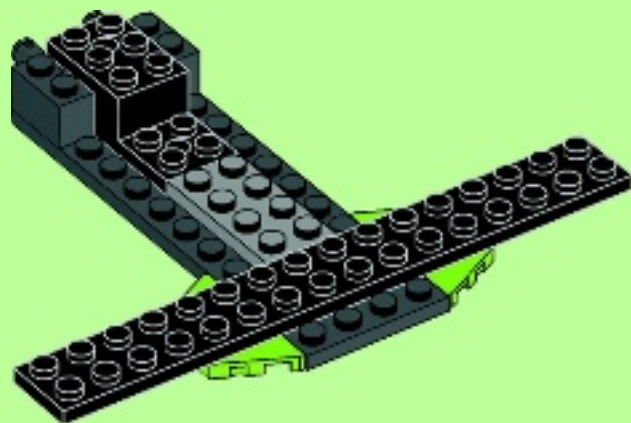



5

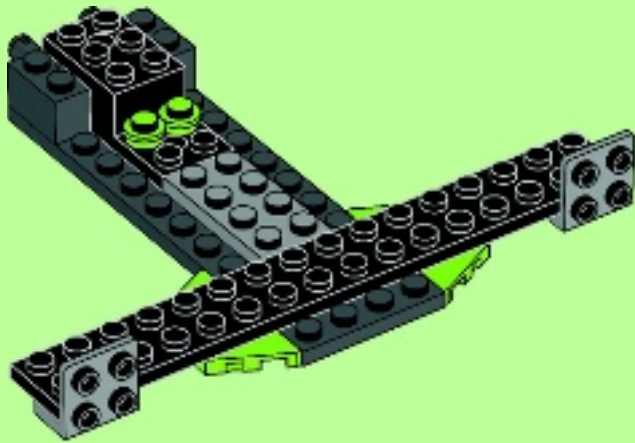

6

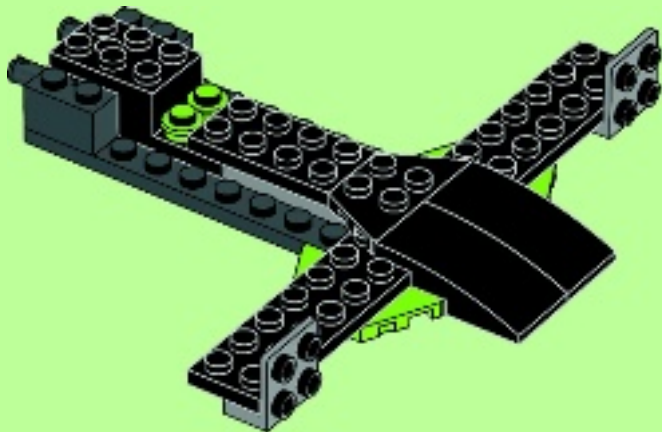



7

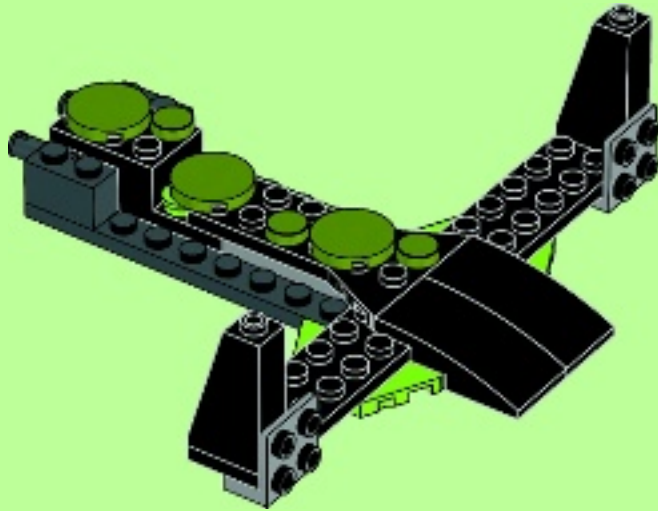

8

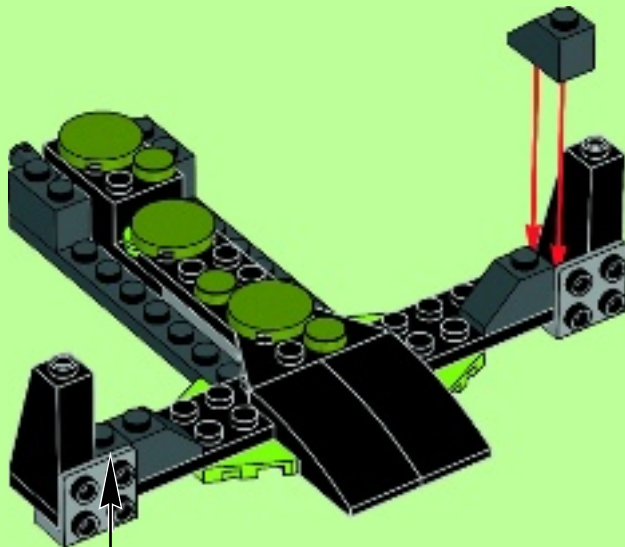

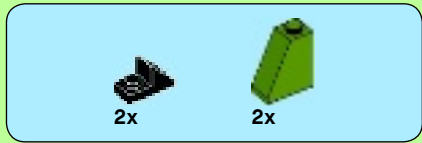

9

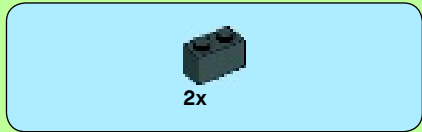
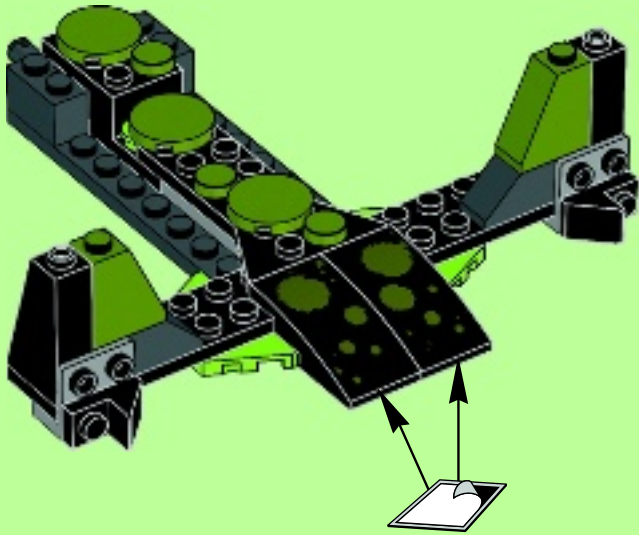

10

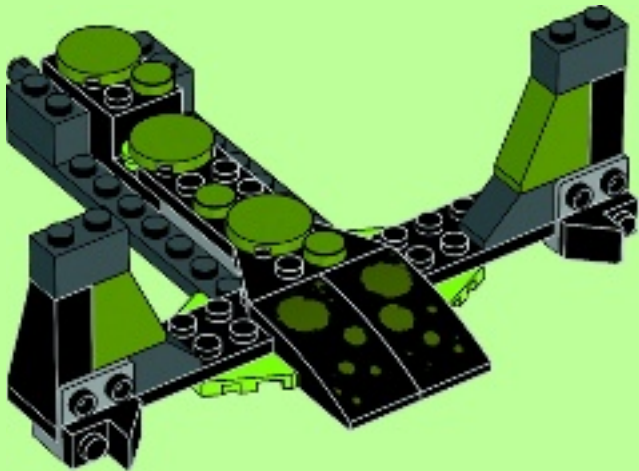



2x

11

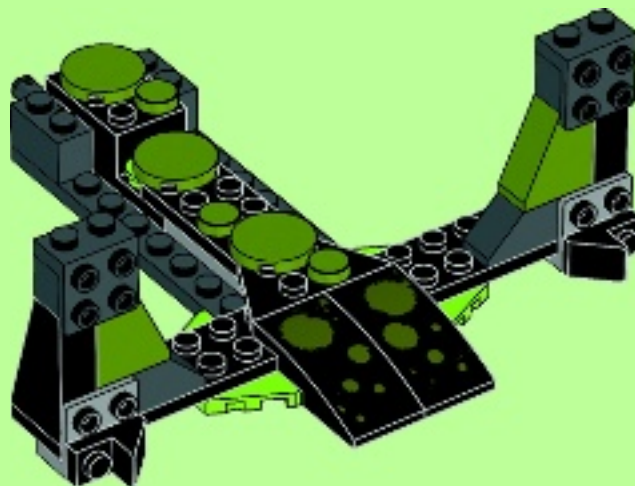

2x

12

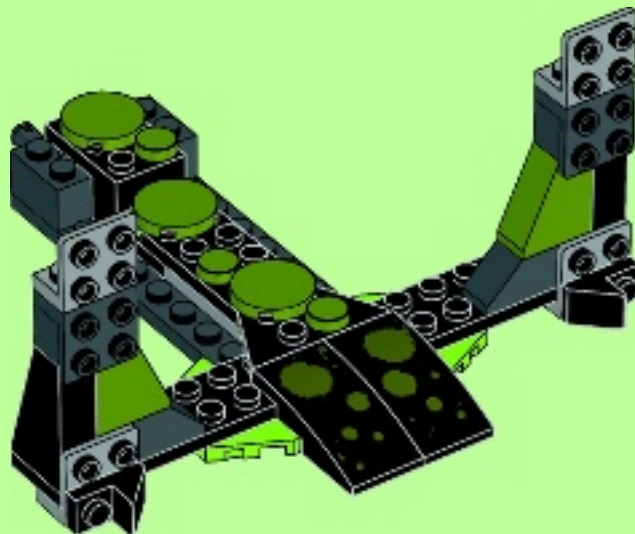

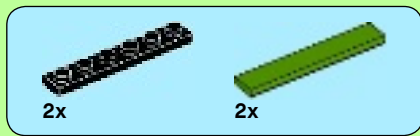

13

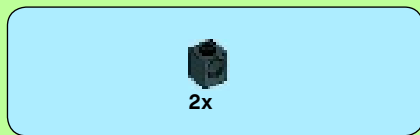
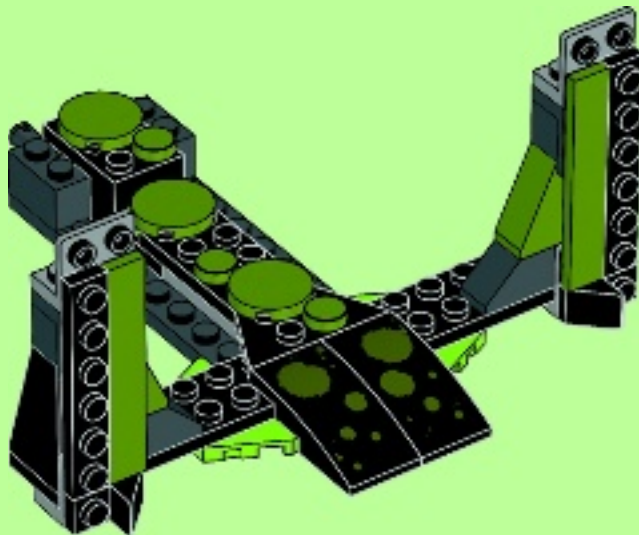

14

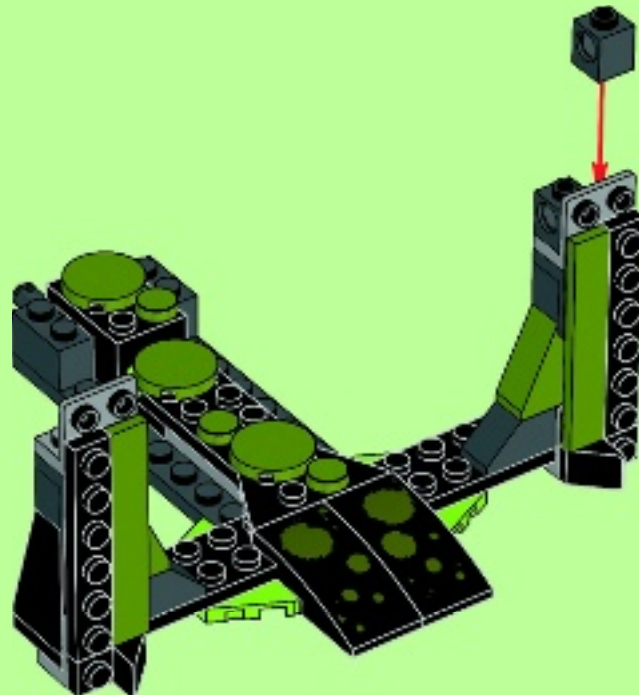



15

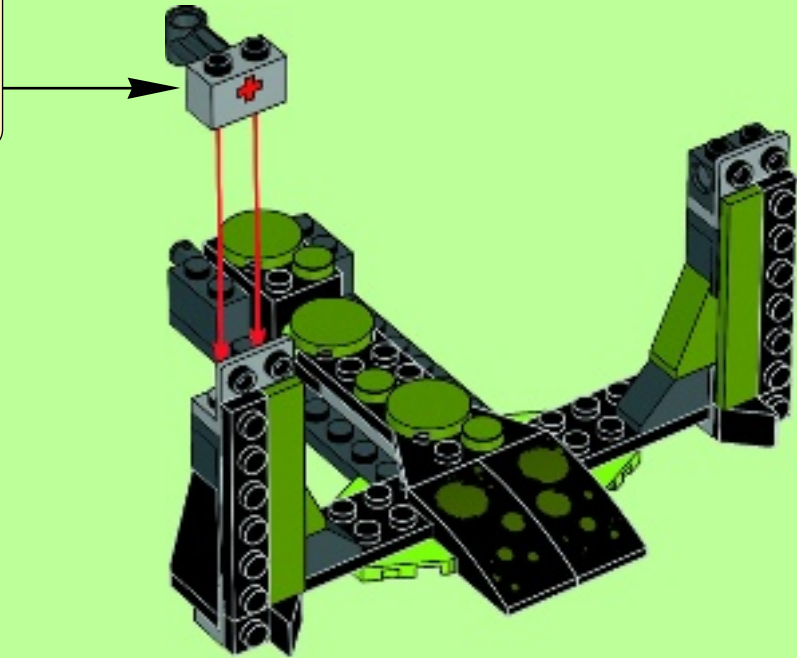
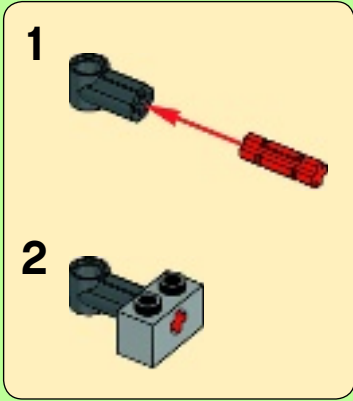



3x



1x

16

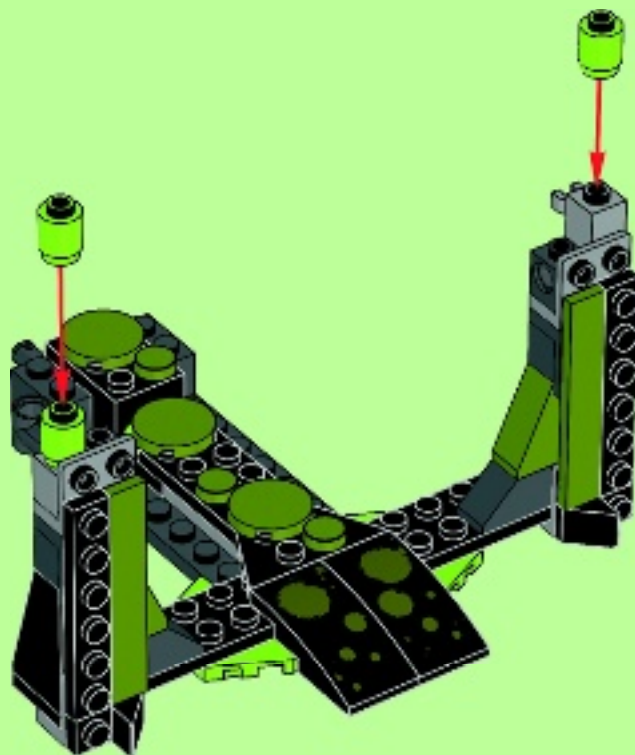

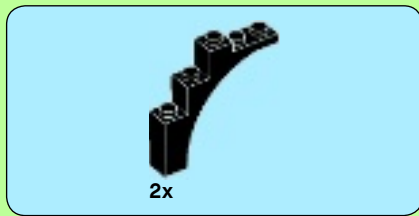

17

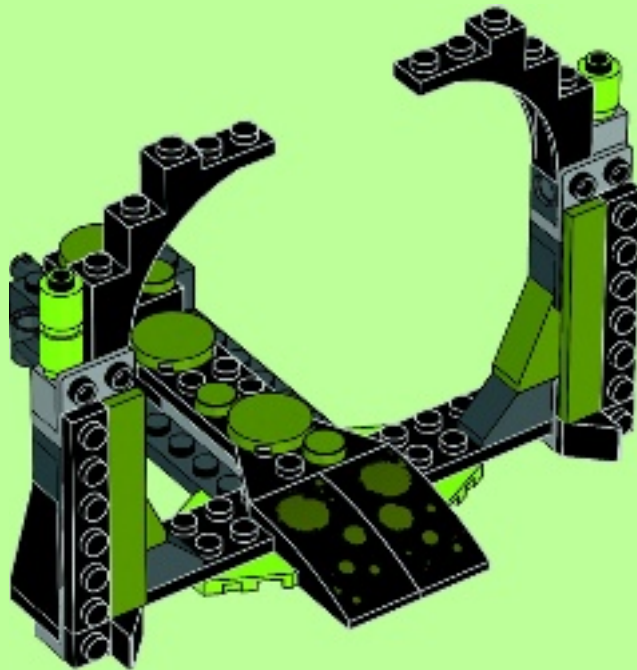



2x

18

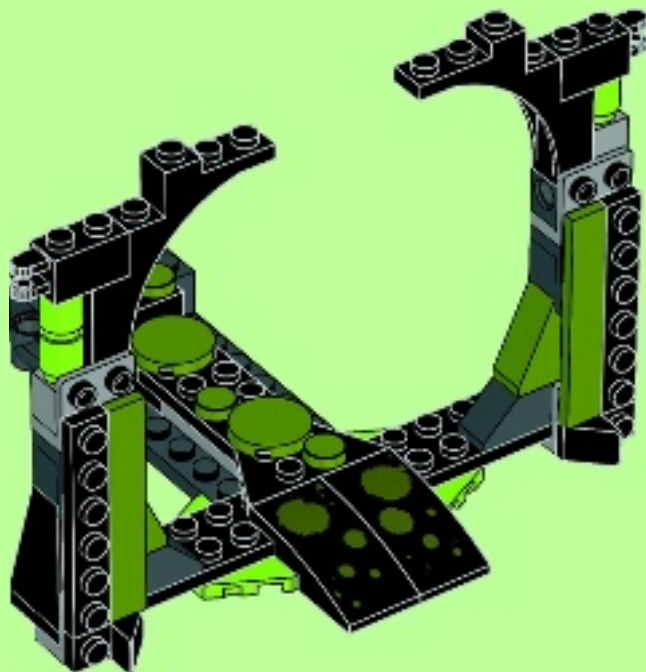



2x

19

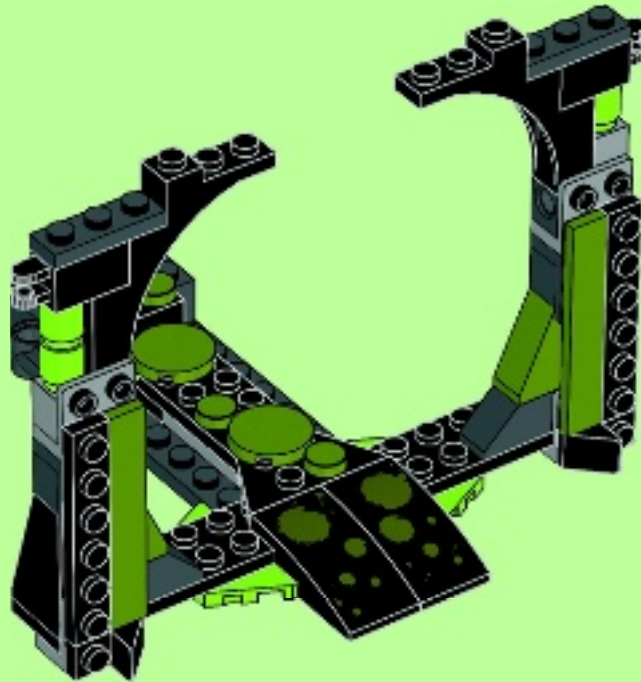



2x

20

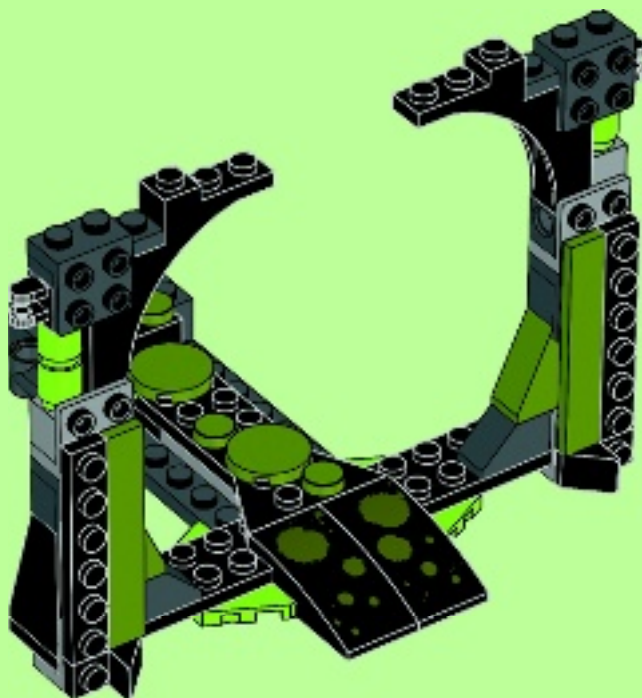

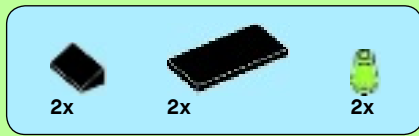

21

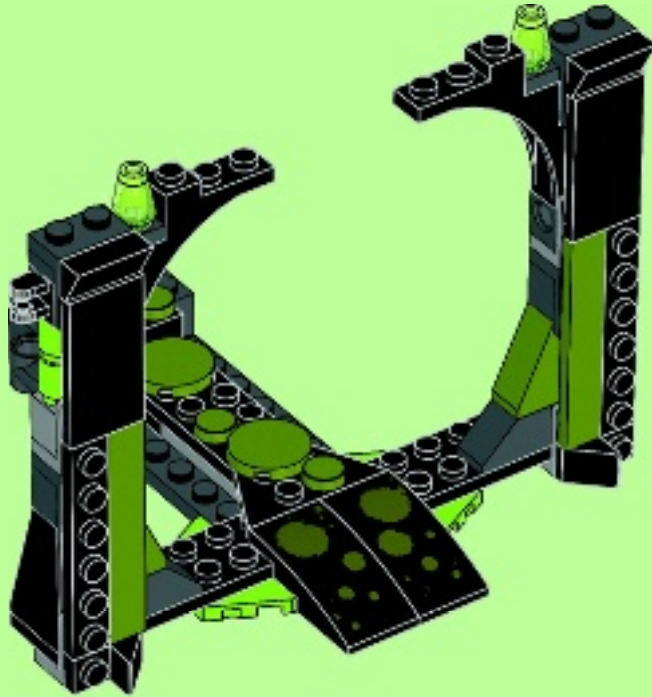

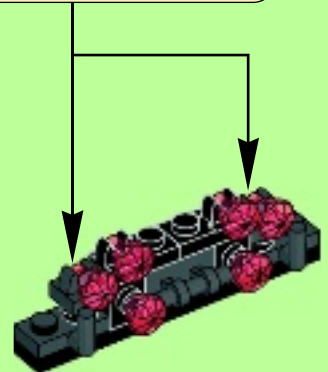
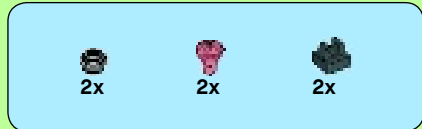

2x

2x

6

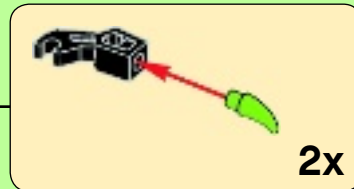
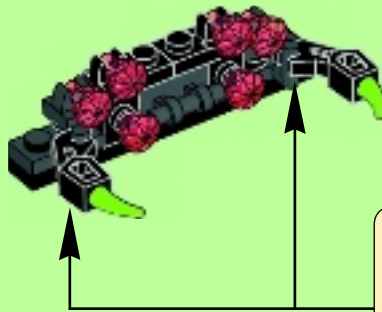

22

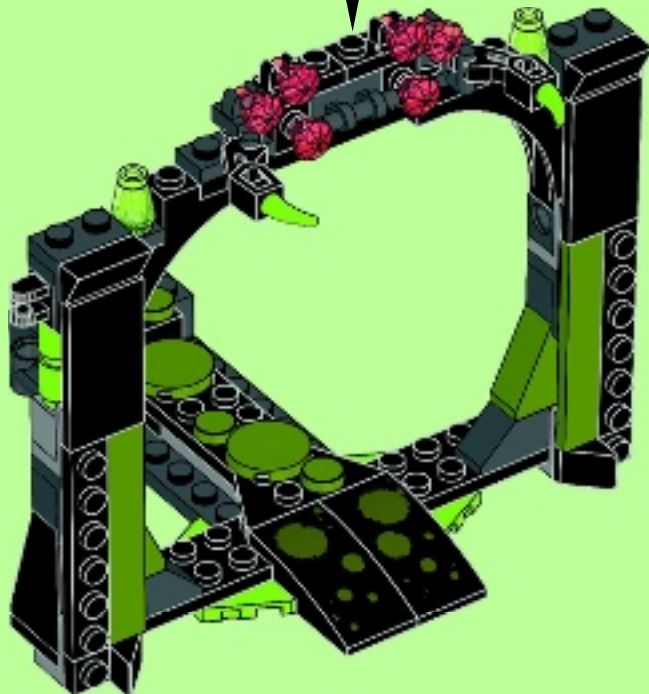



2x

23

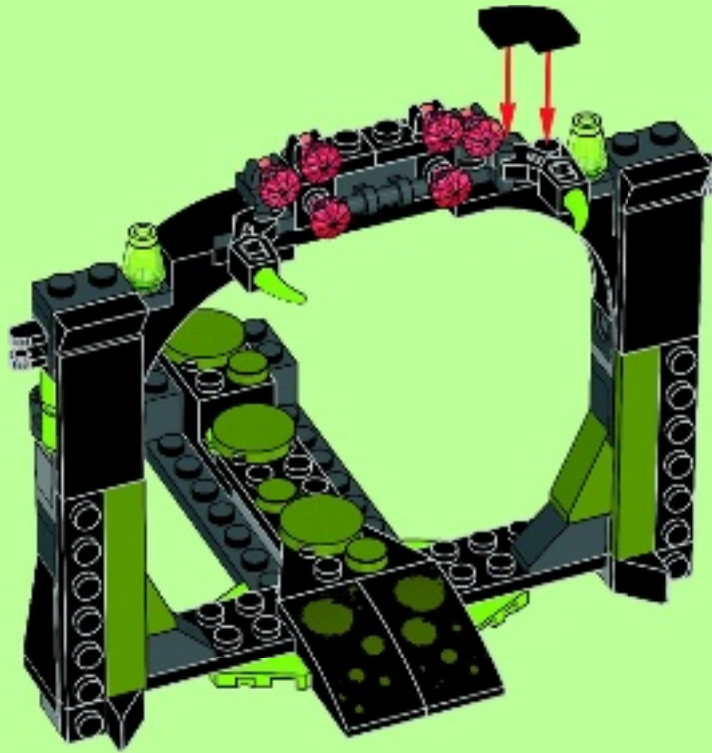



4x



2x

24

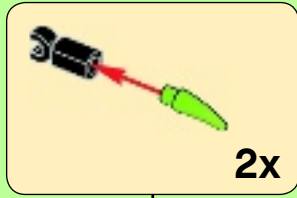

2x

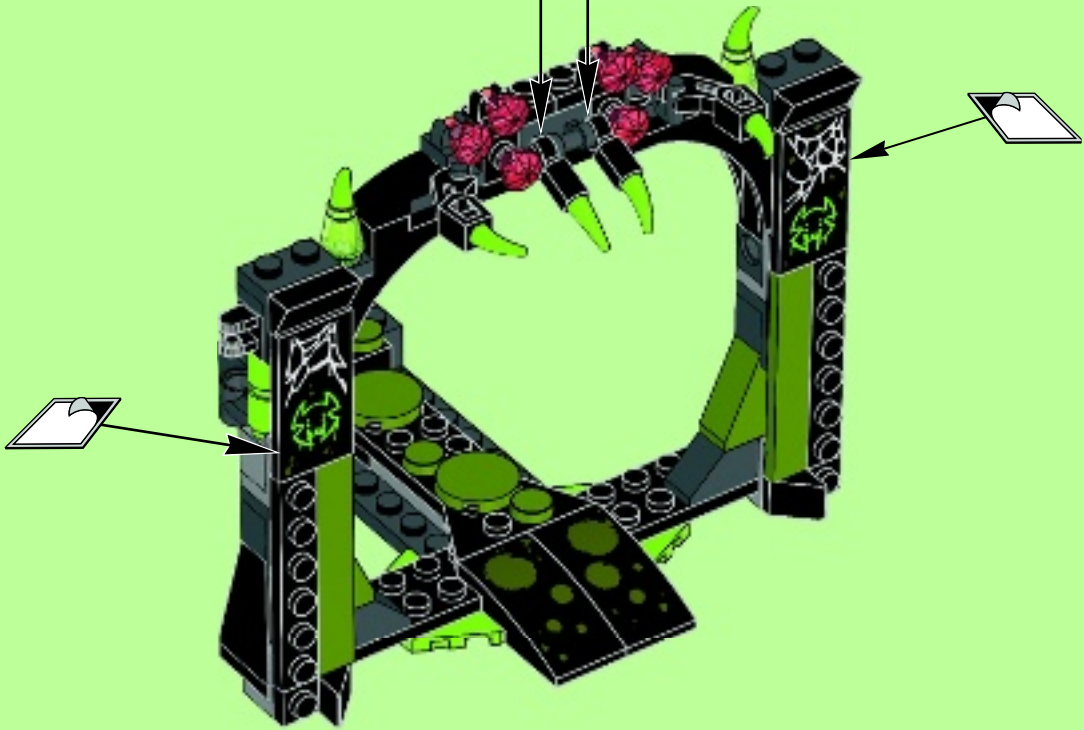

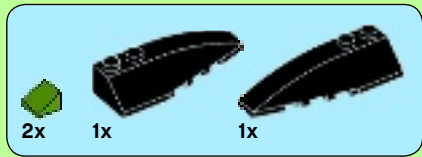

25

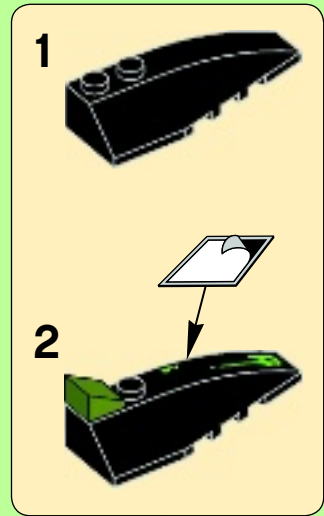
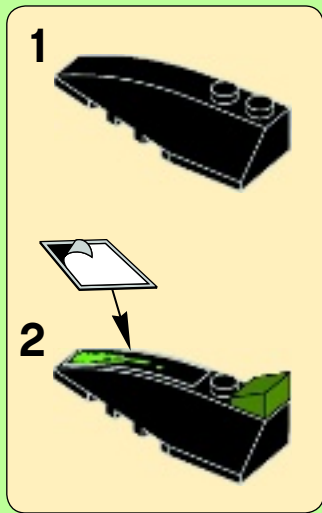



26

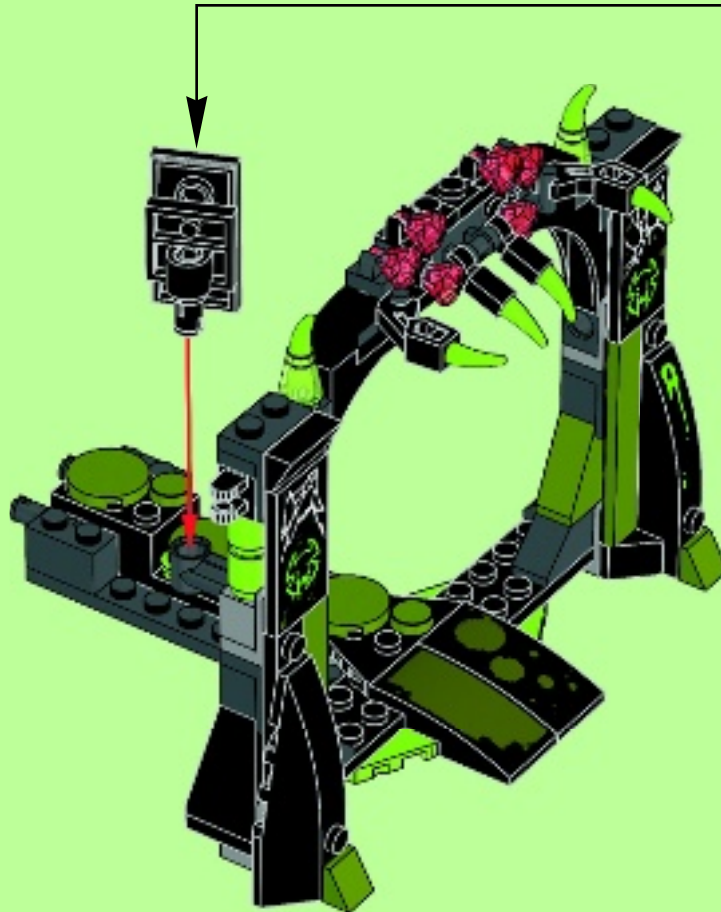
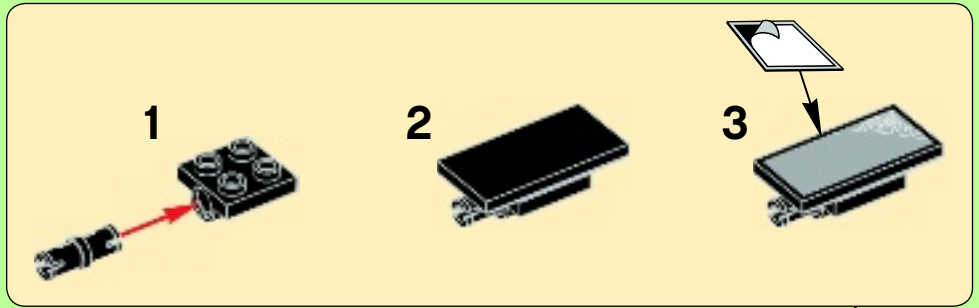

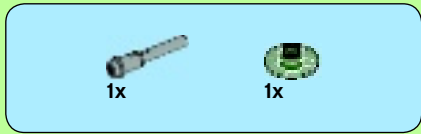

27

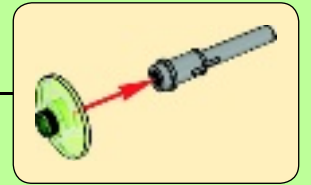

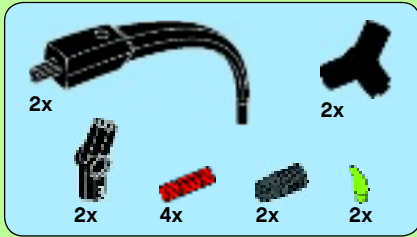

28

1



2



3



4

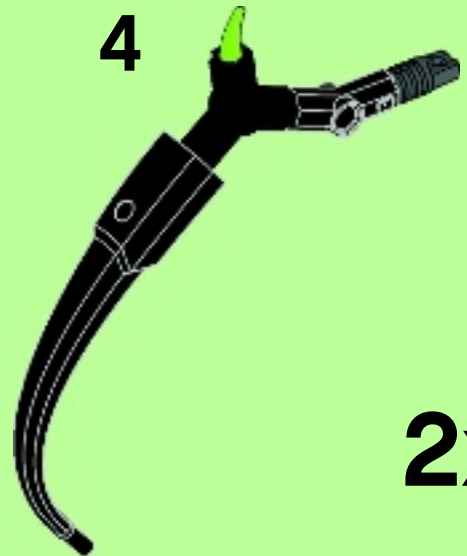

2x

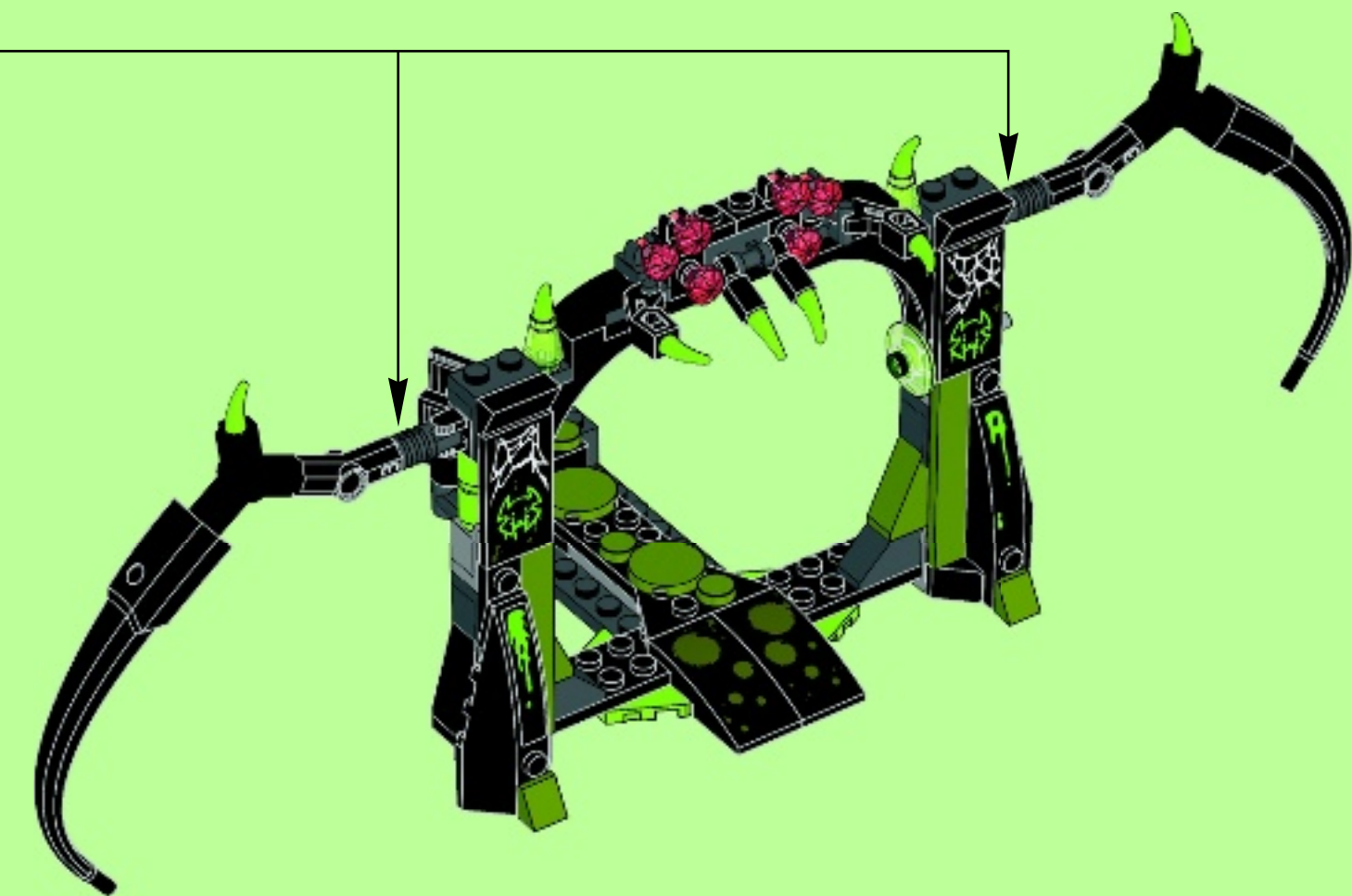



4x

29

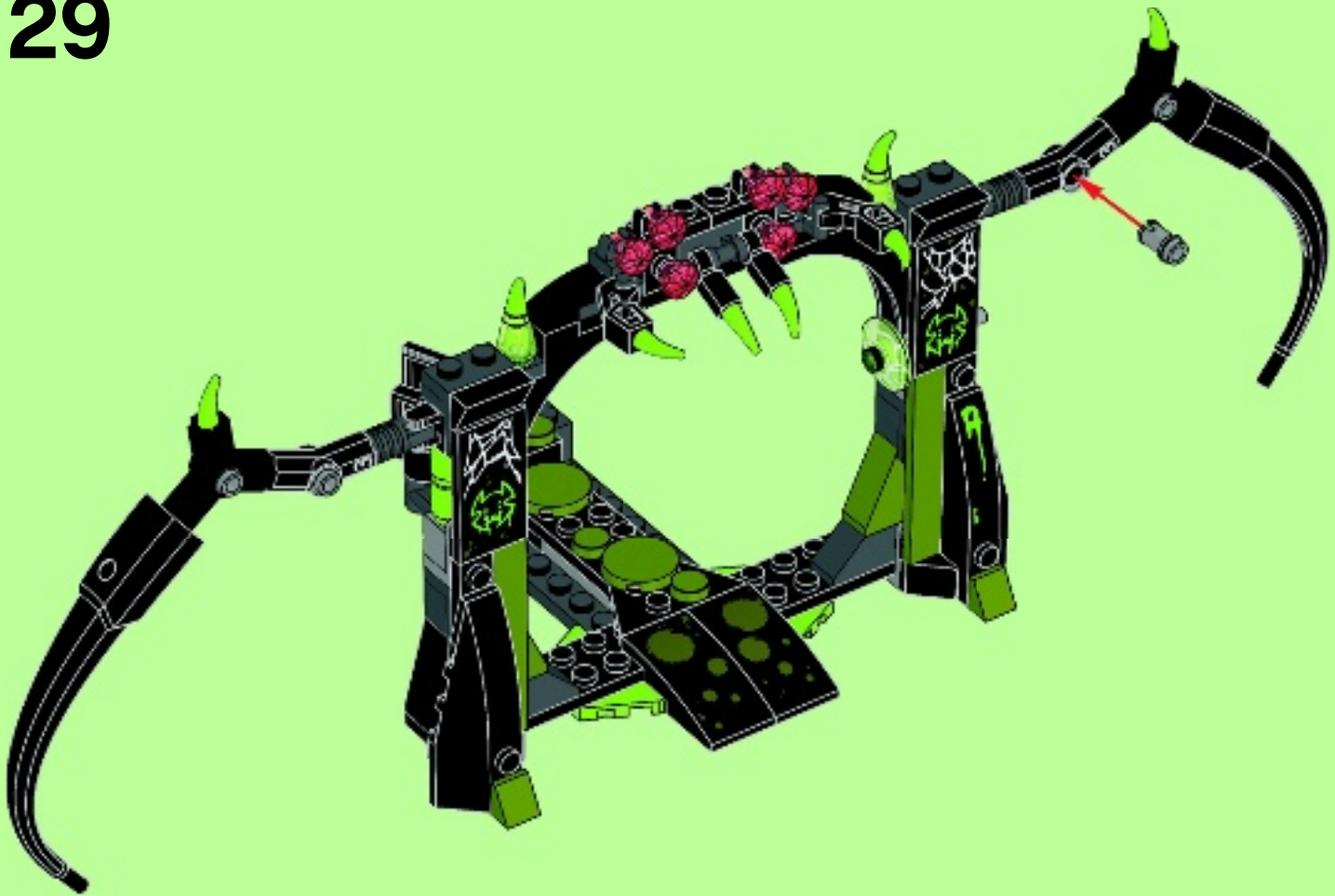



1x



3x

30



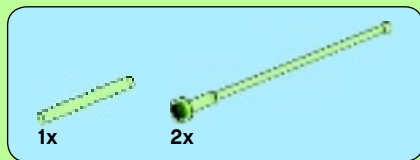

31



32

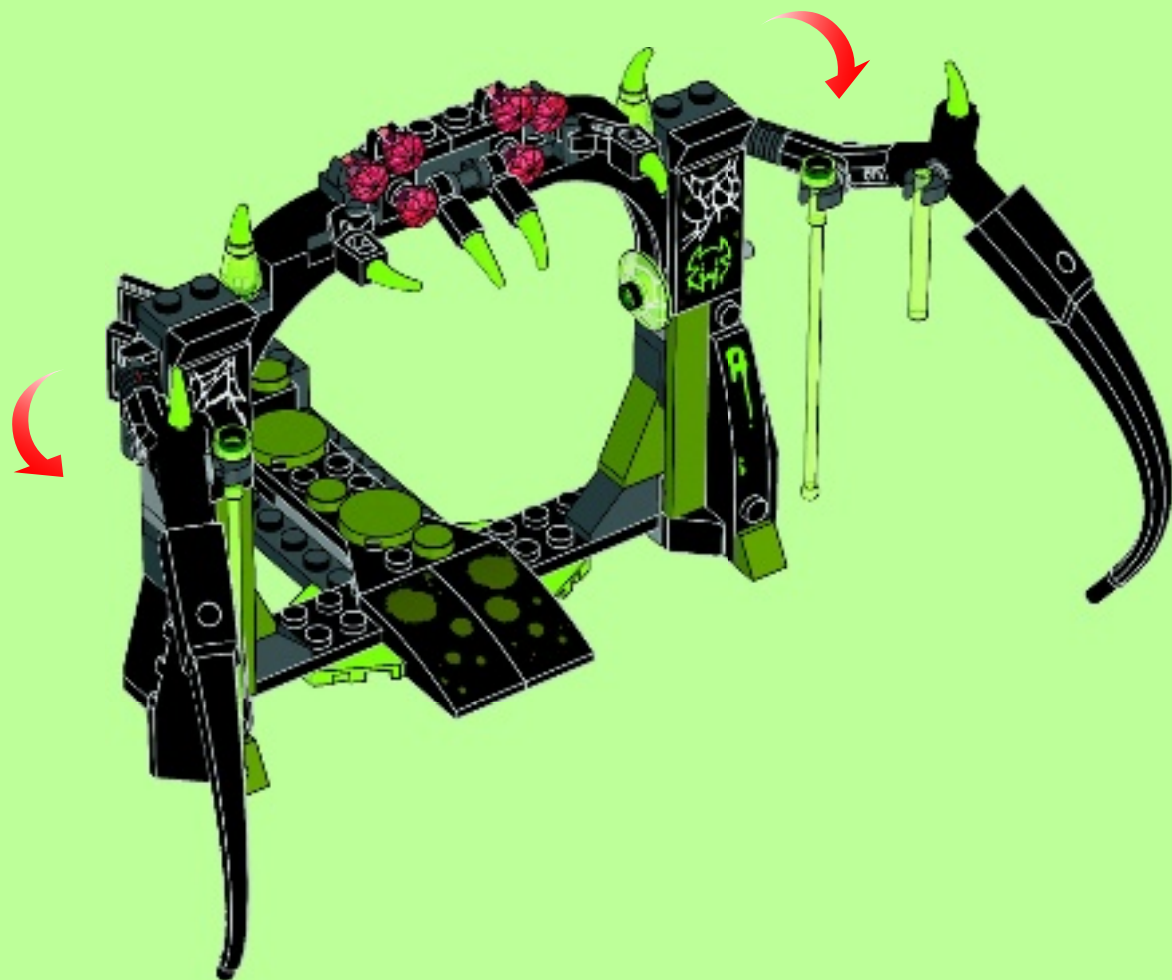

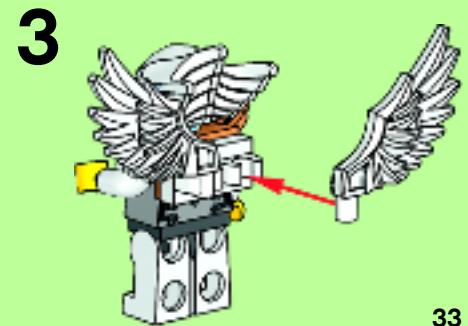
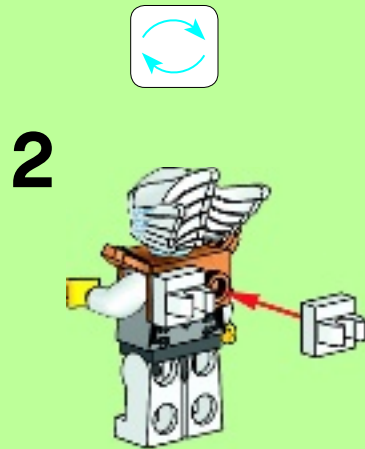
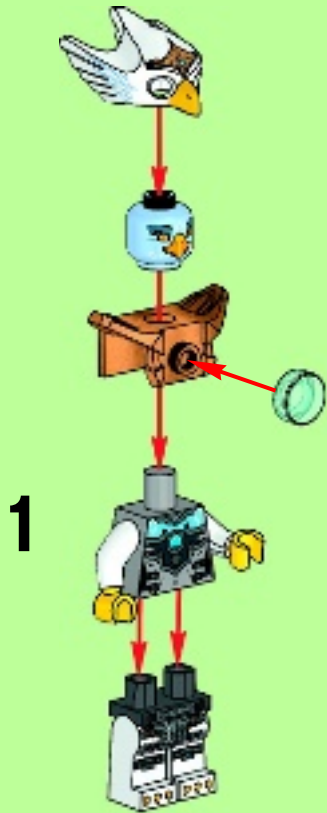
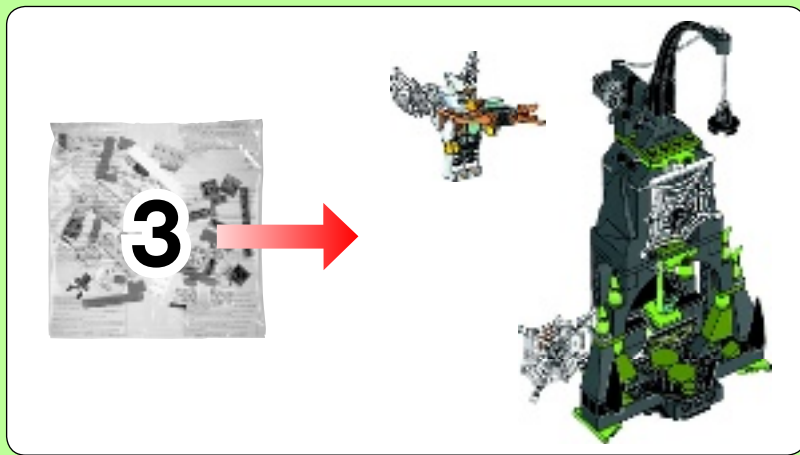

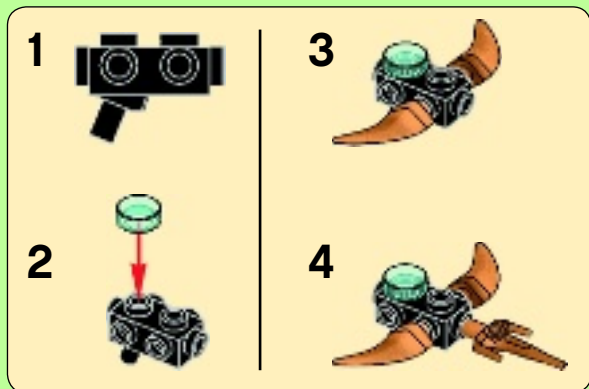

1

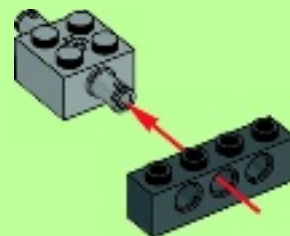

4





2

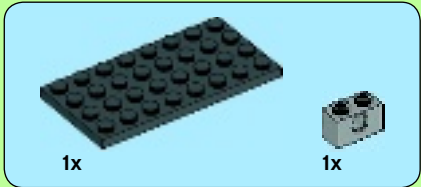

3

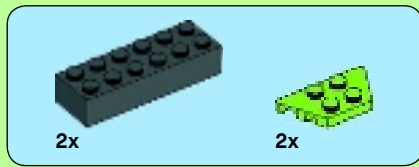
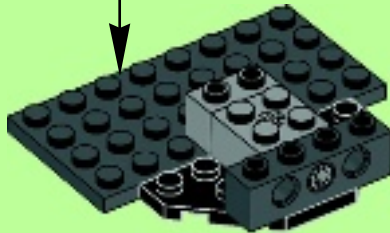

4

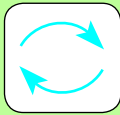
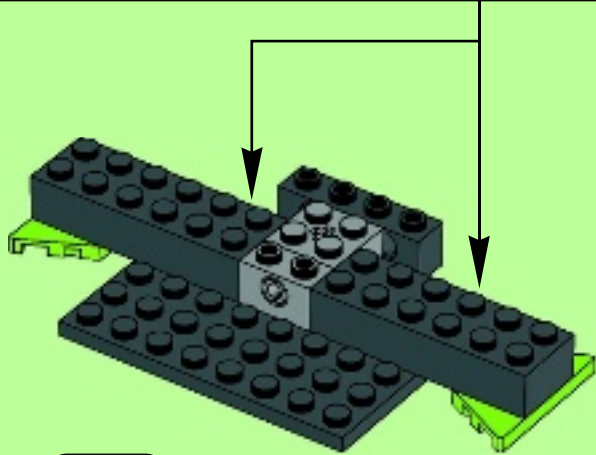
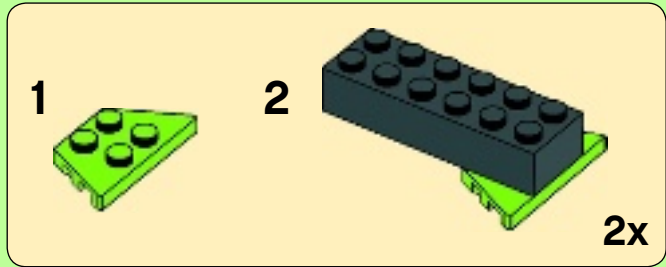



5

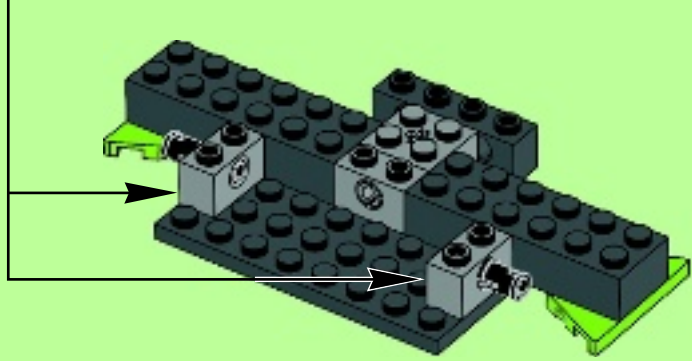
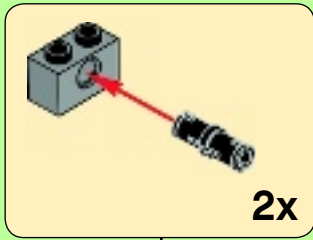

6

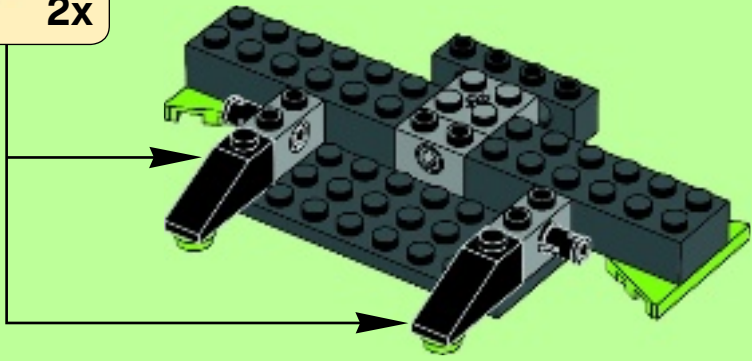
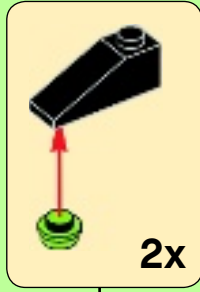

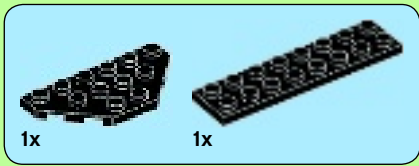

7



8

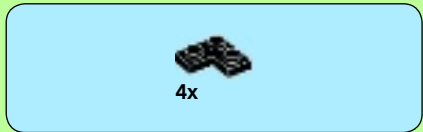

9

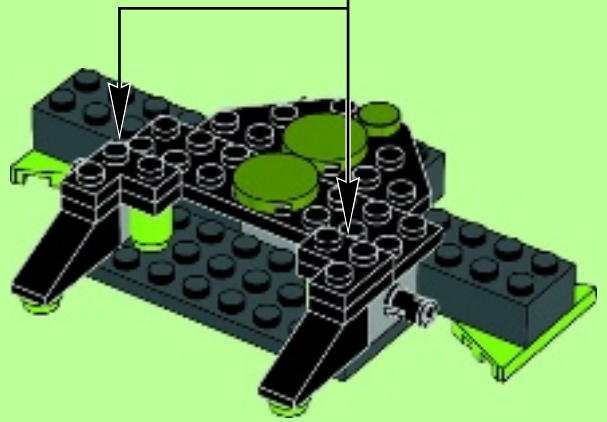
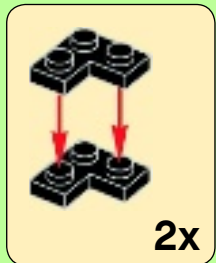

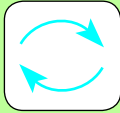
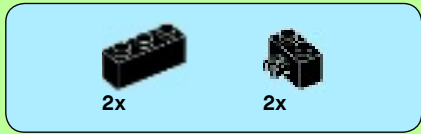

10

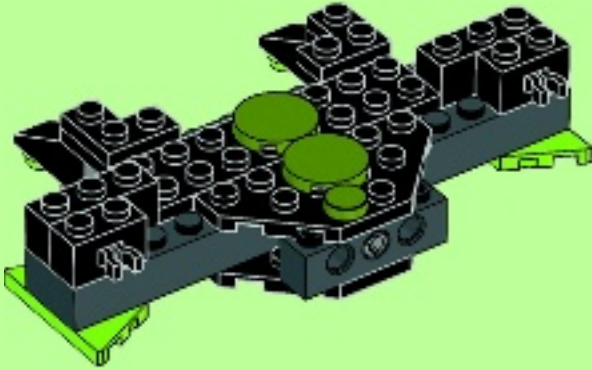

11

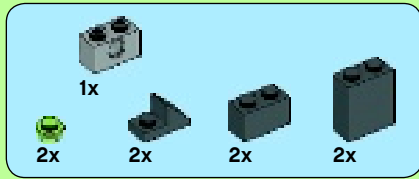
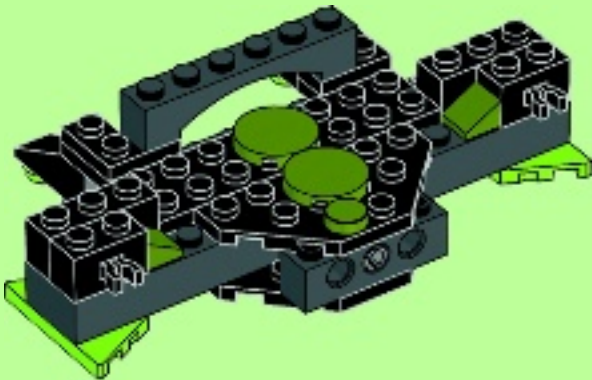

12

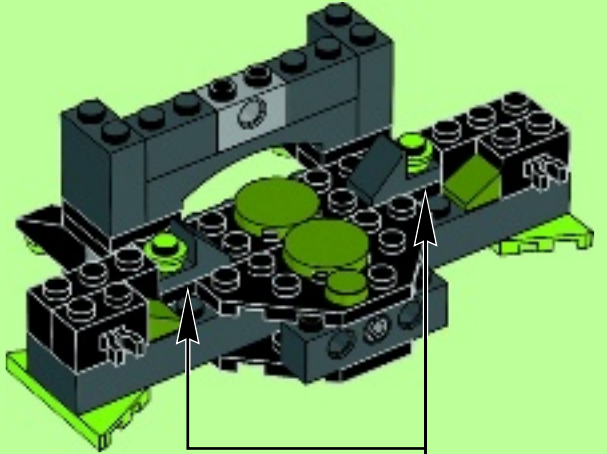

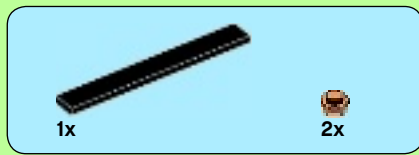

13

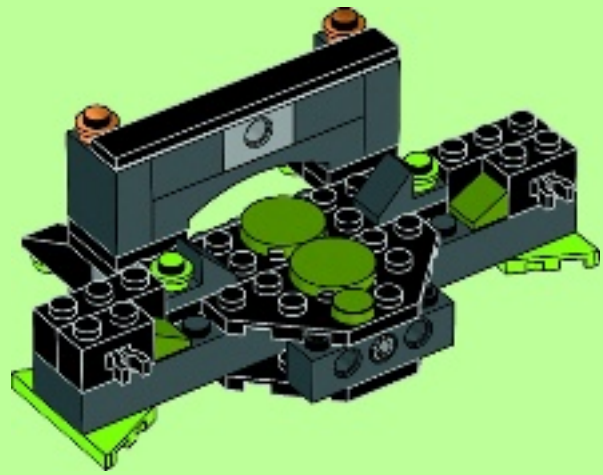

14

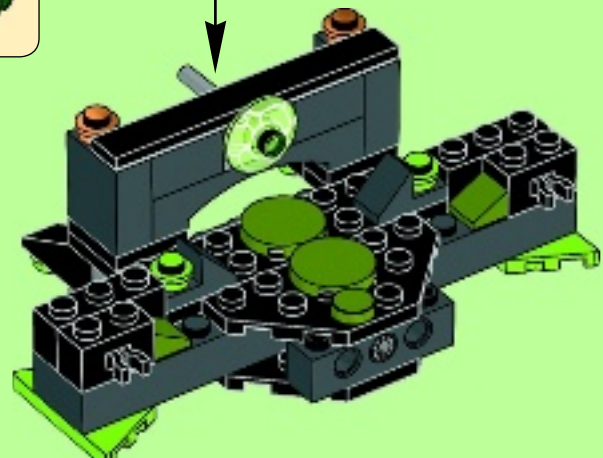
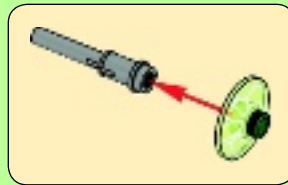



1x

1



1x

2

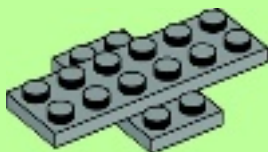

2x

3



1x



2x

4





5

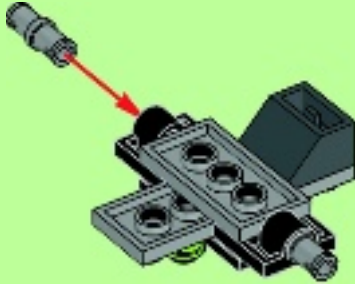

7



8

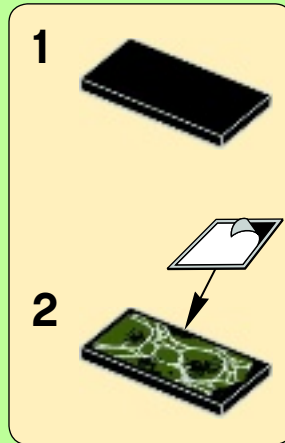

6

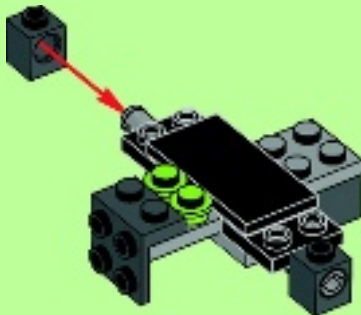

15

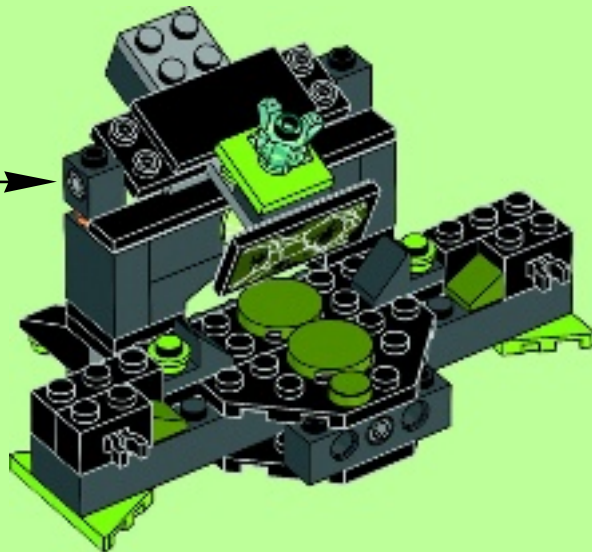

2x

16

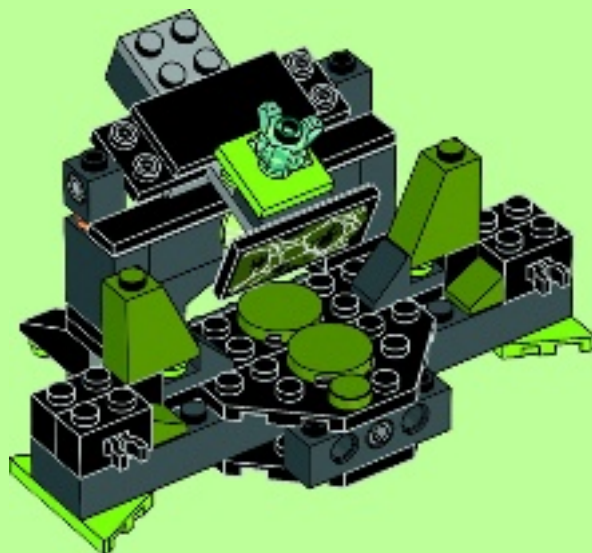



17



18

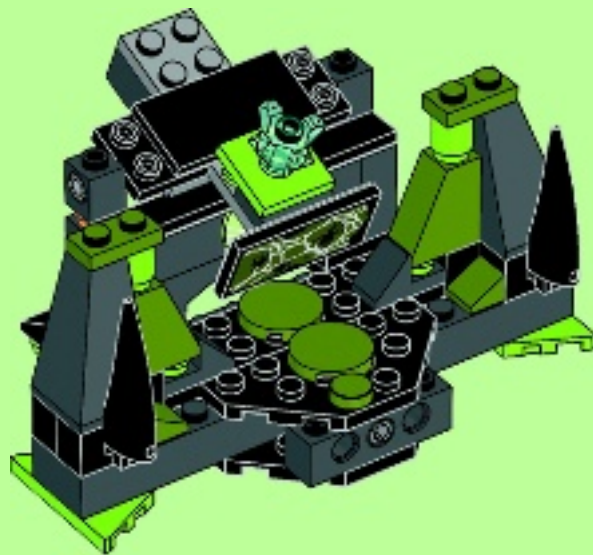



2x



2x

19

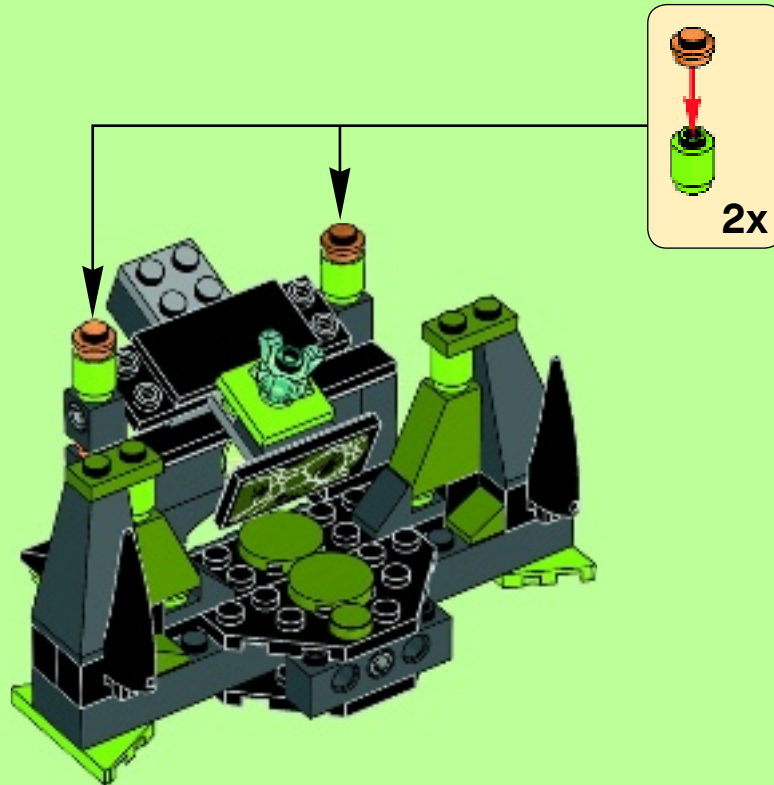

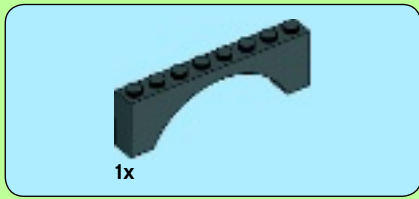

20

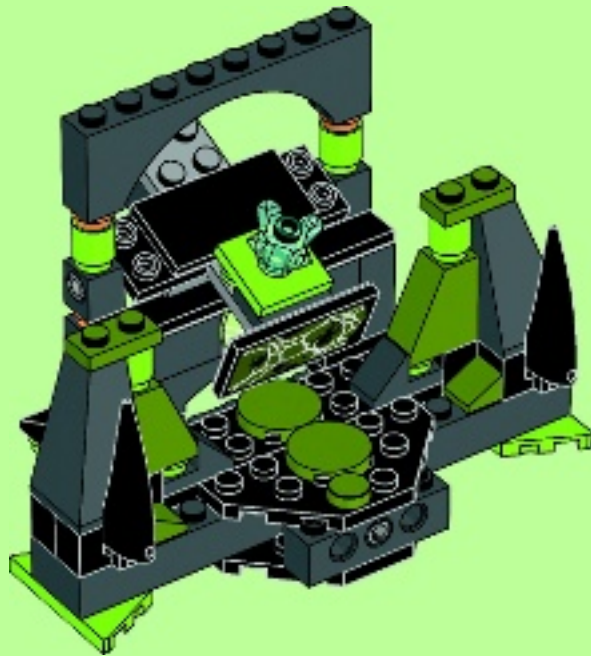



1x



1x

21

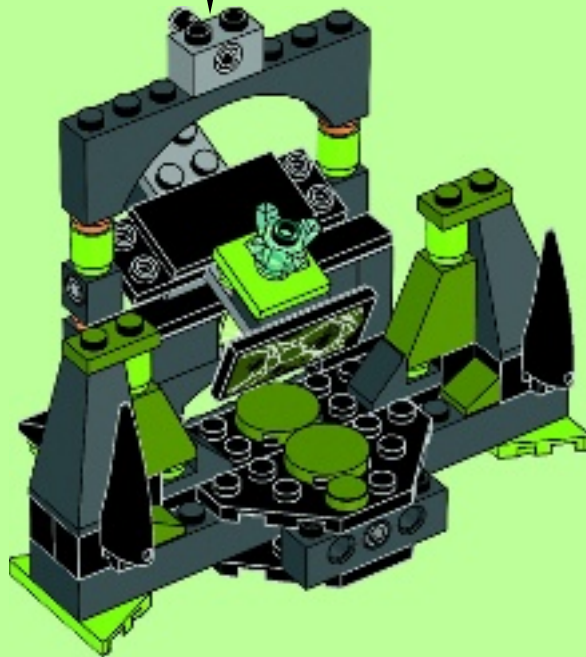
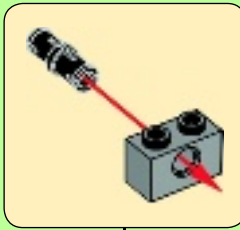

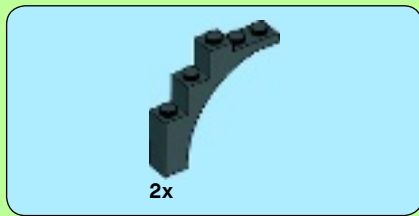

22

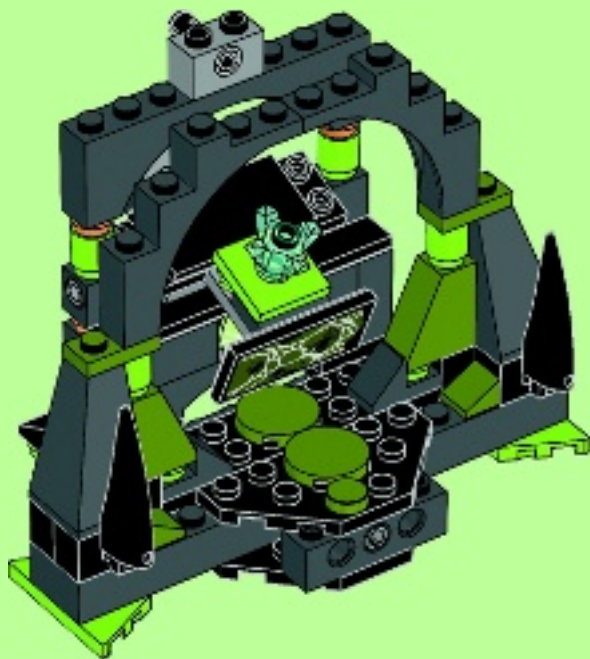

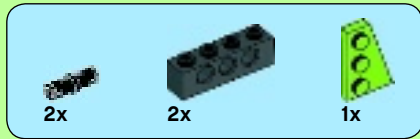

23

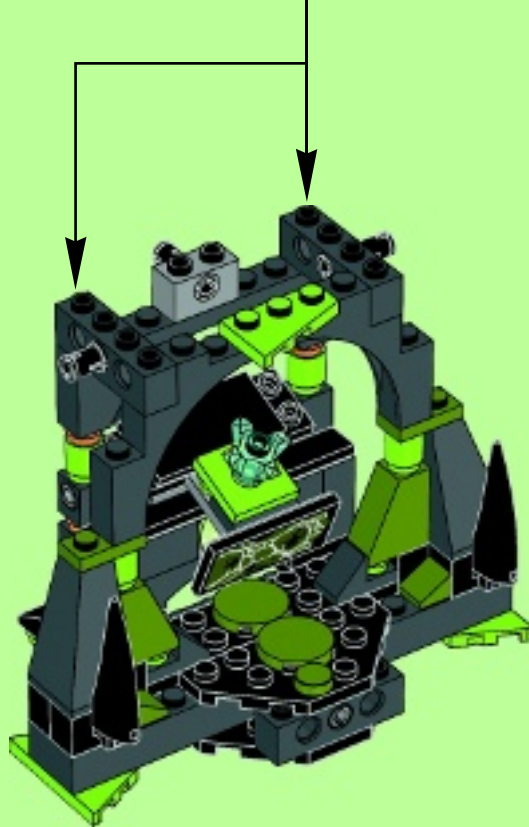
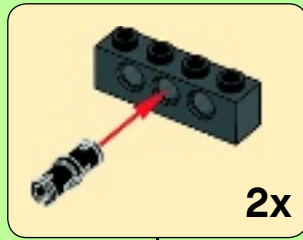



1x

24

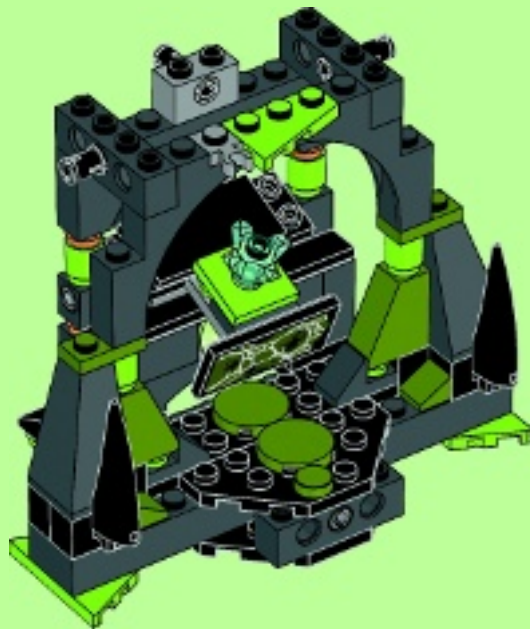

1x

25

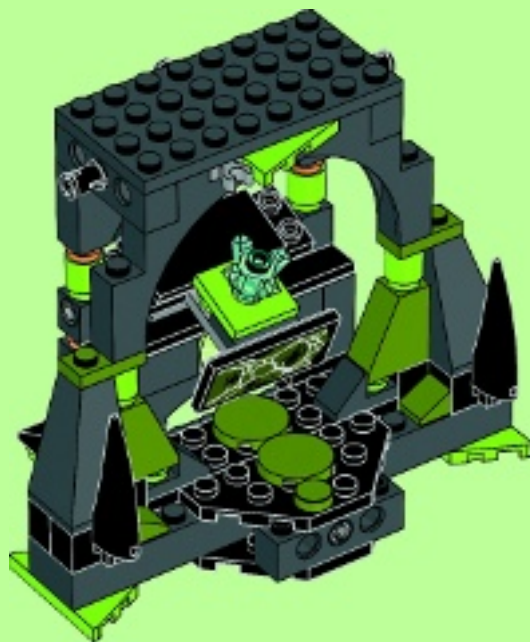

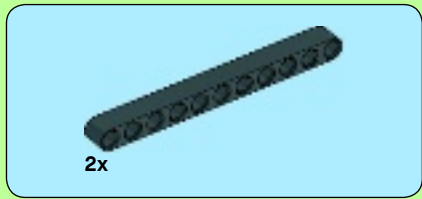

26

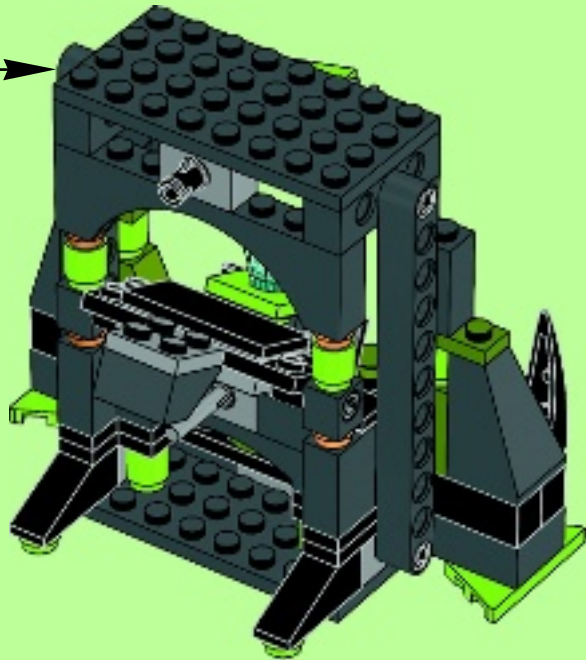

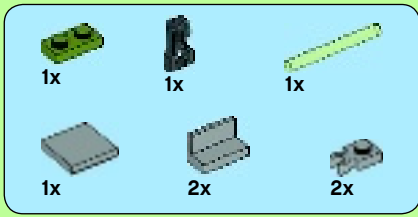

27

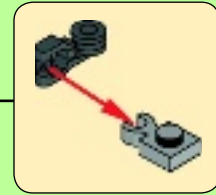
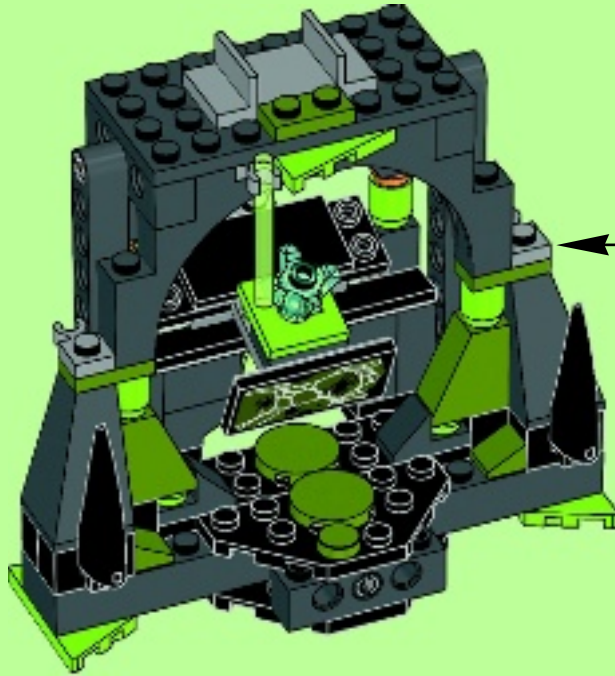



4x



4x

28



4x

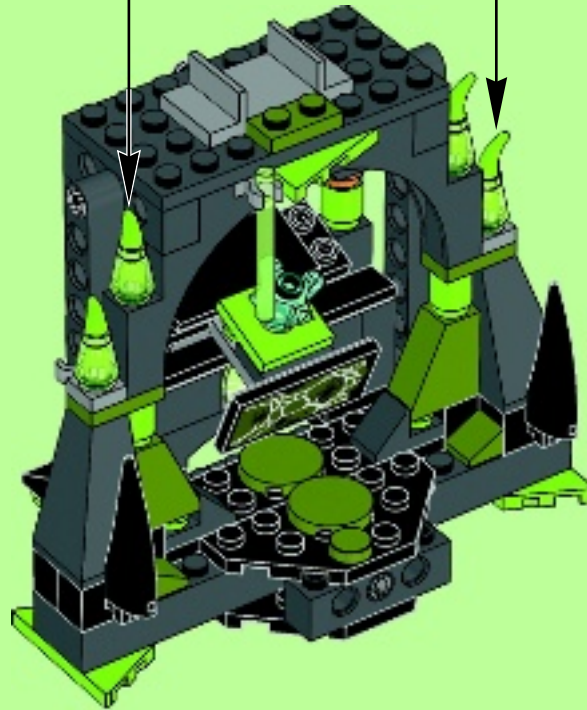



2x

29

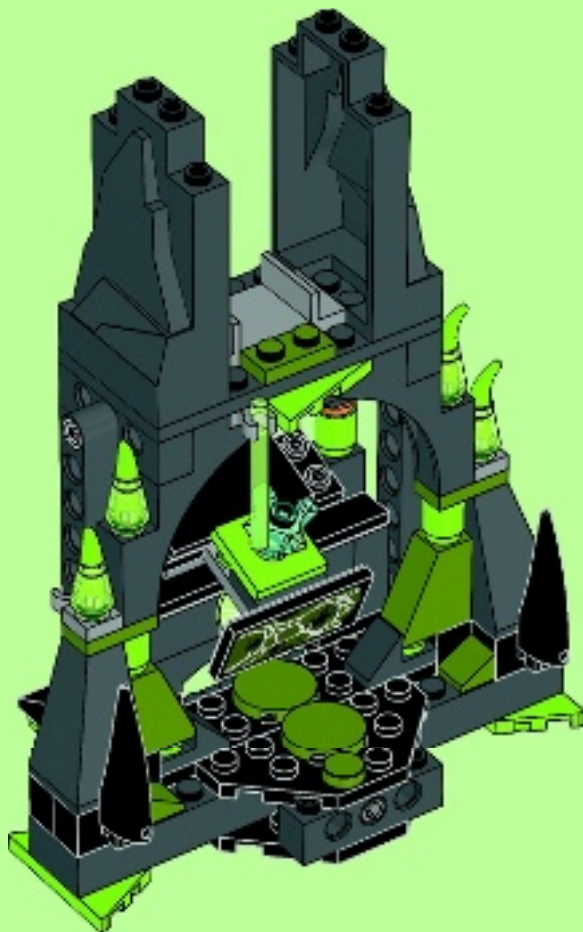

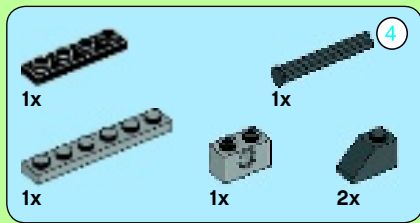

30

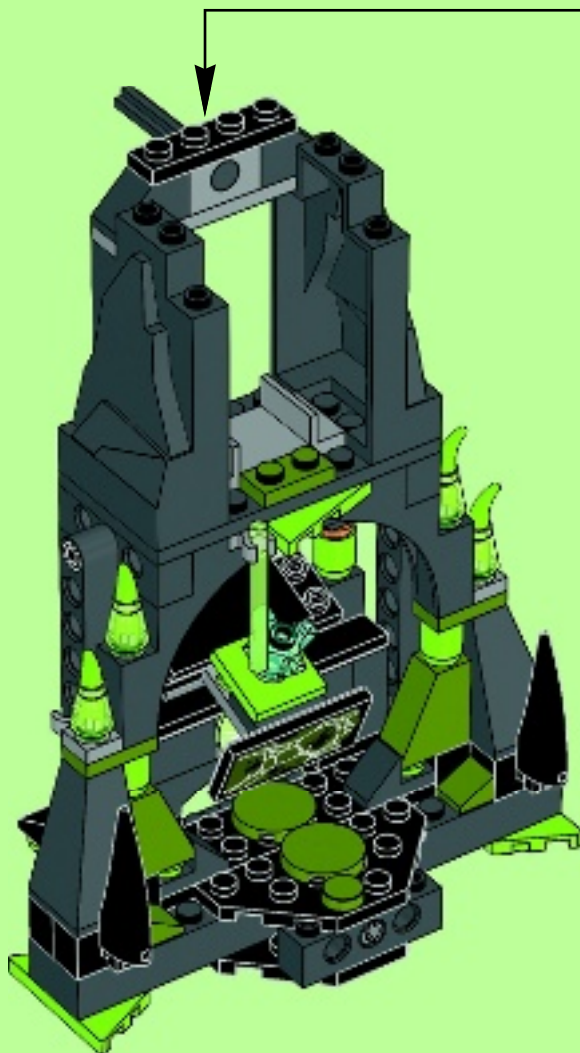



31

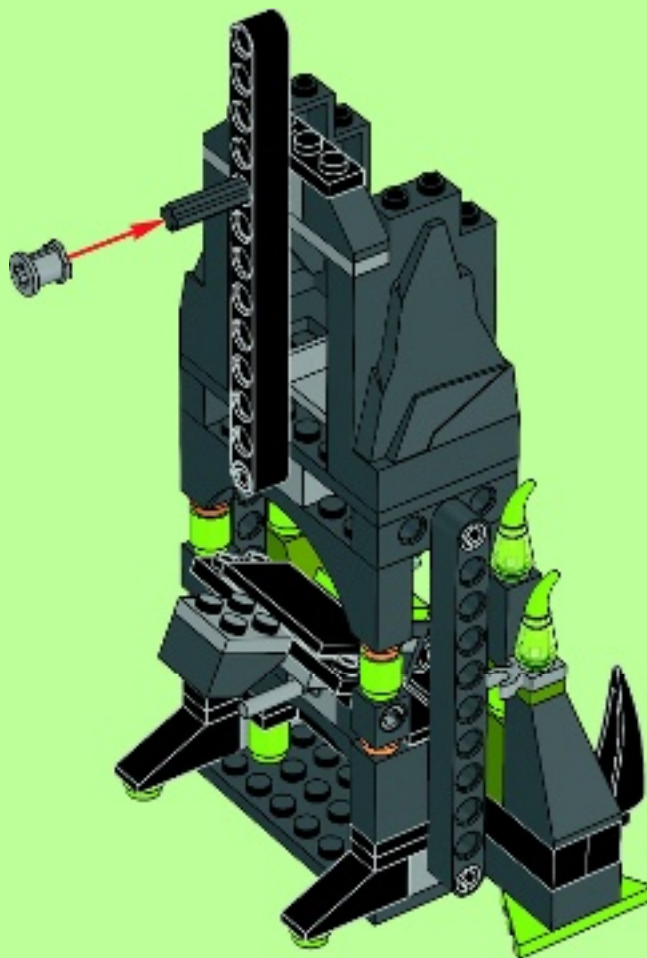

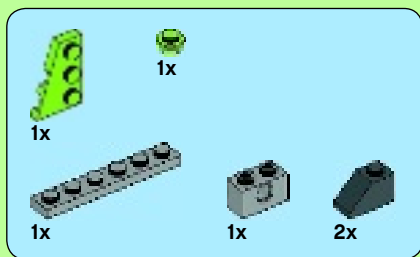

32

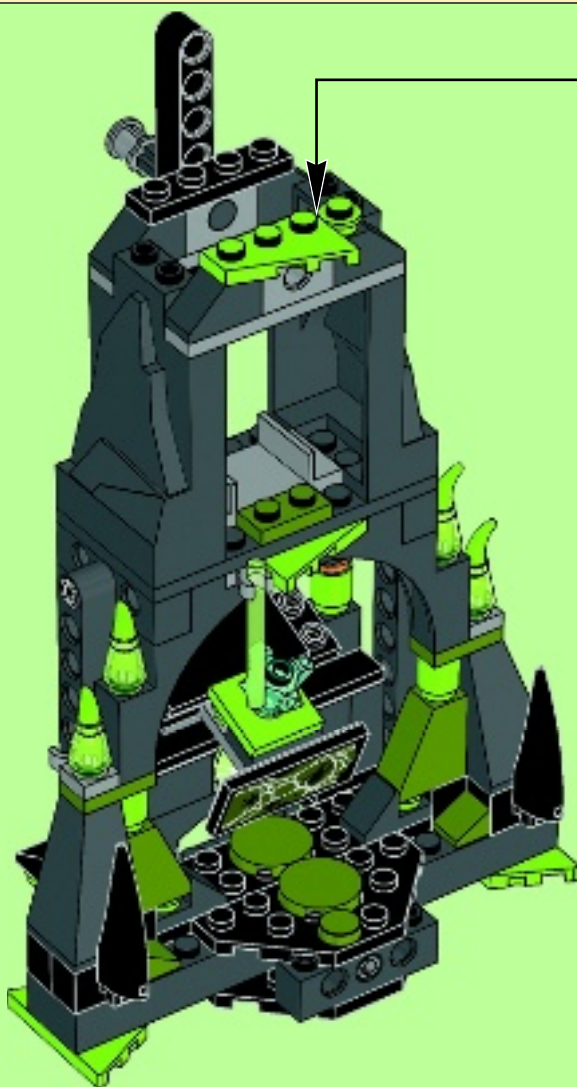



2x

33

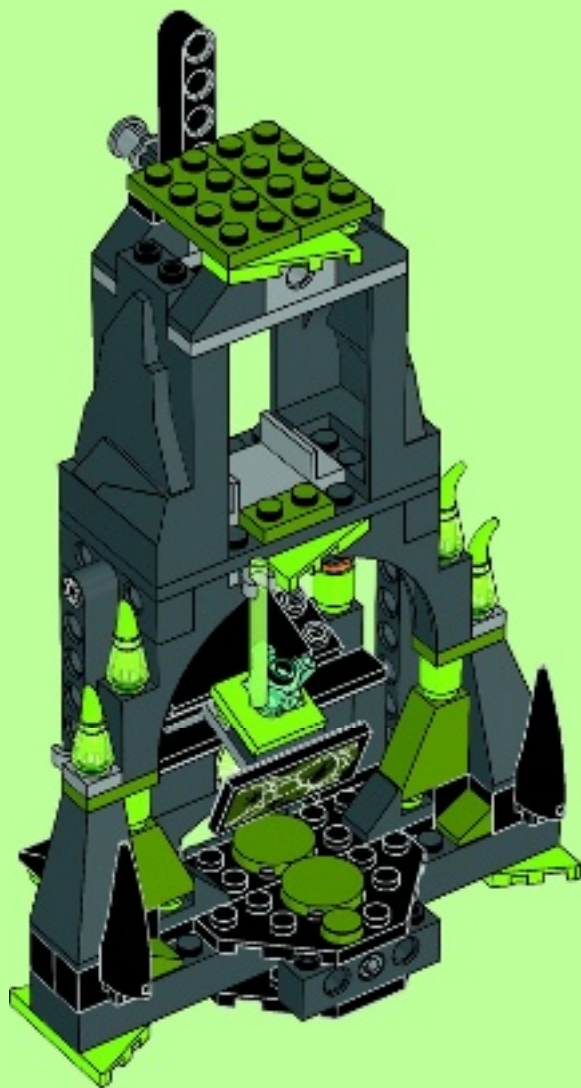



34

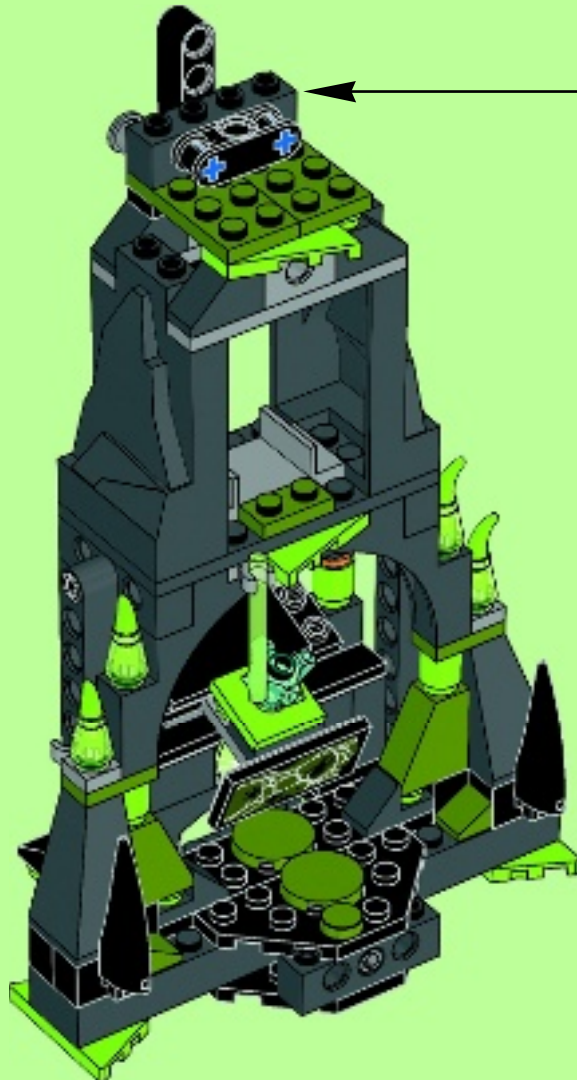
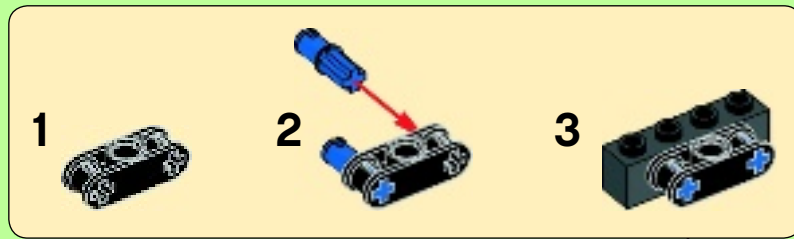



1x



2x

35

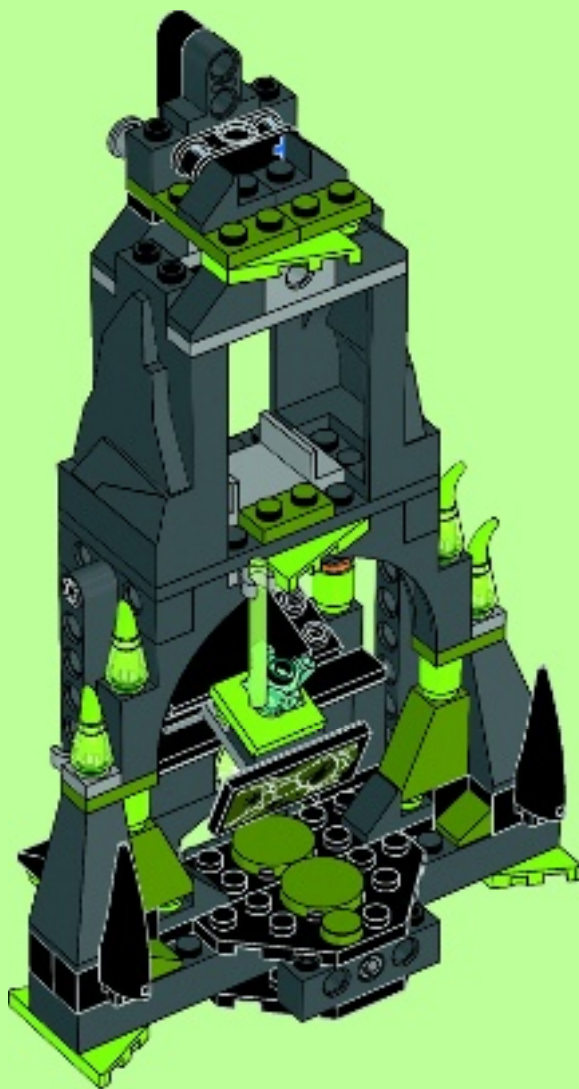

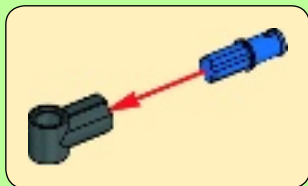

36

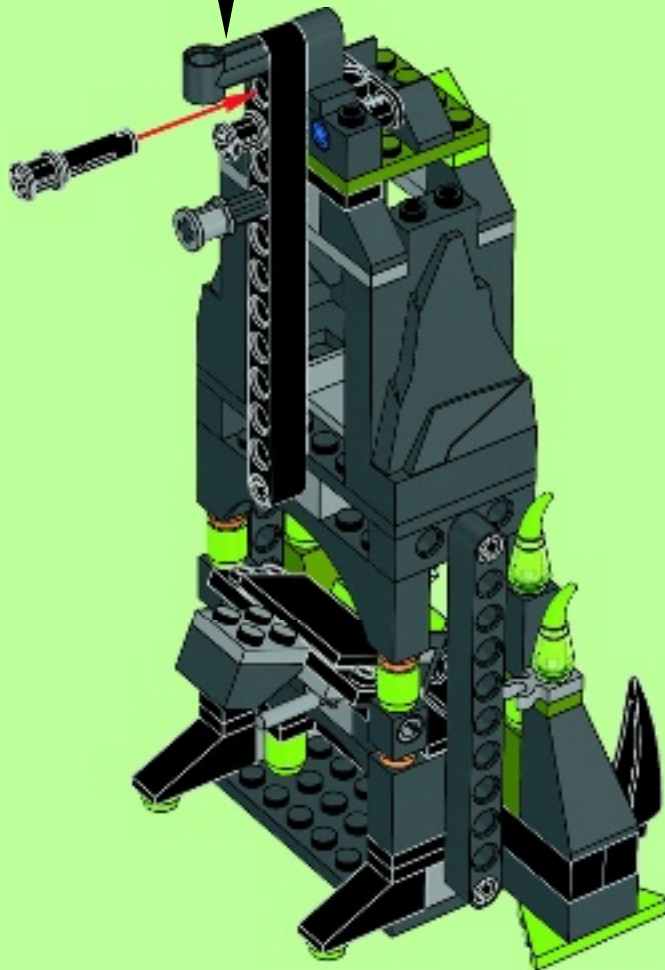

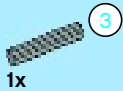

37





1x



1x

38

1



2





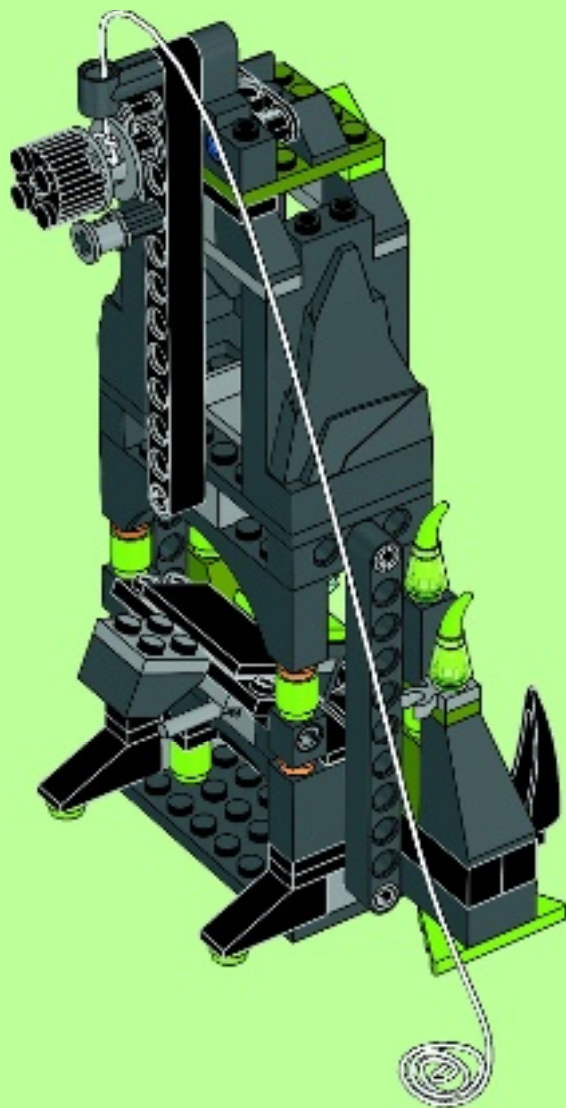

1x

39



1x  1x  1x 

40

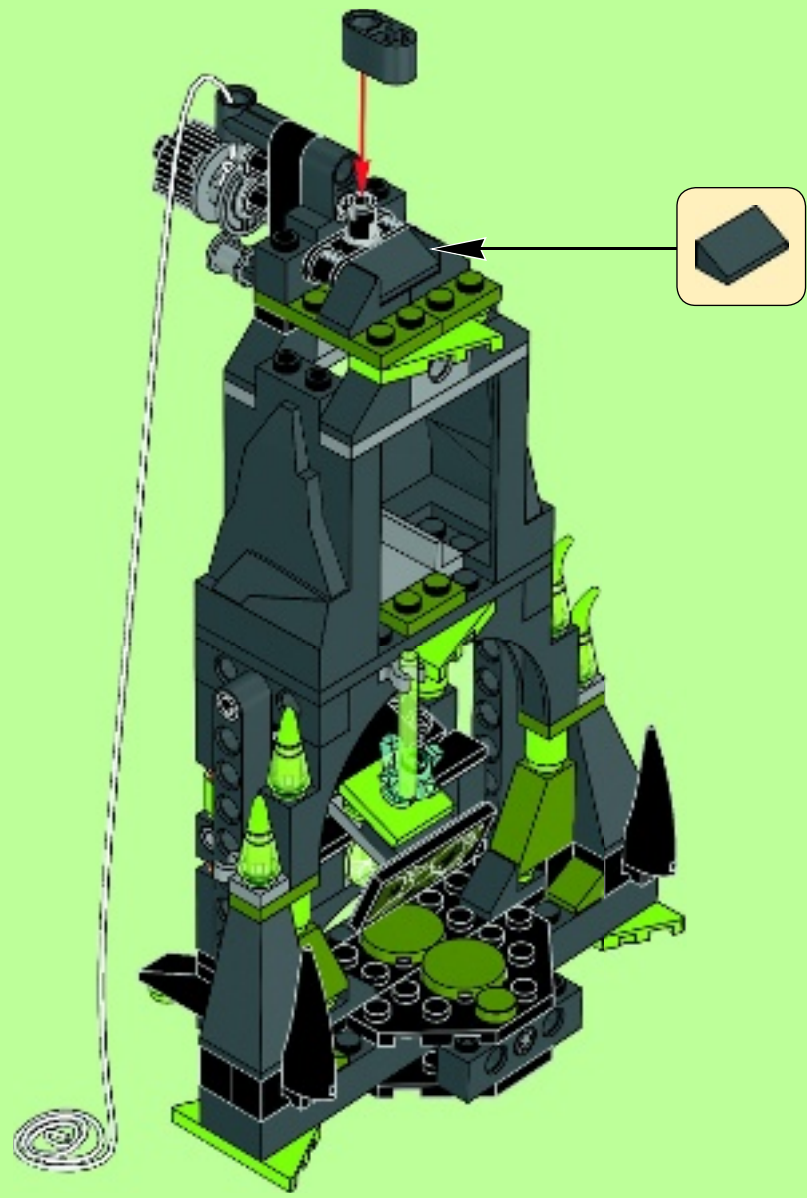

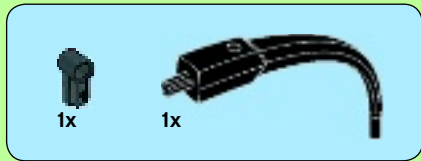

41

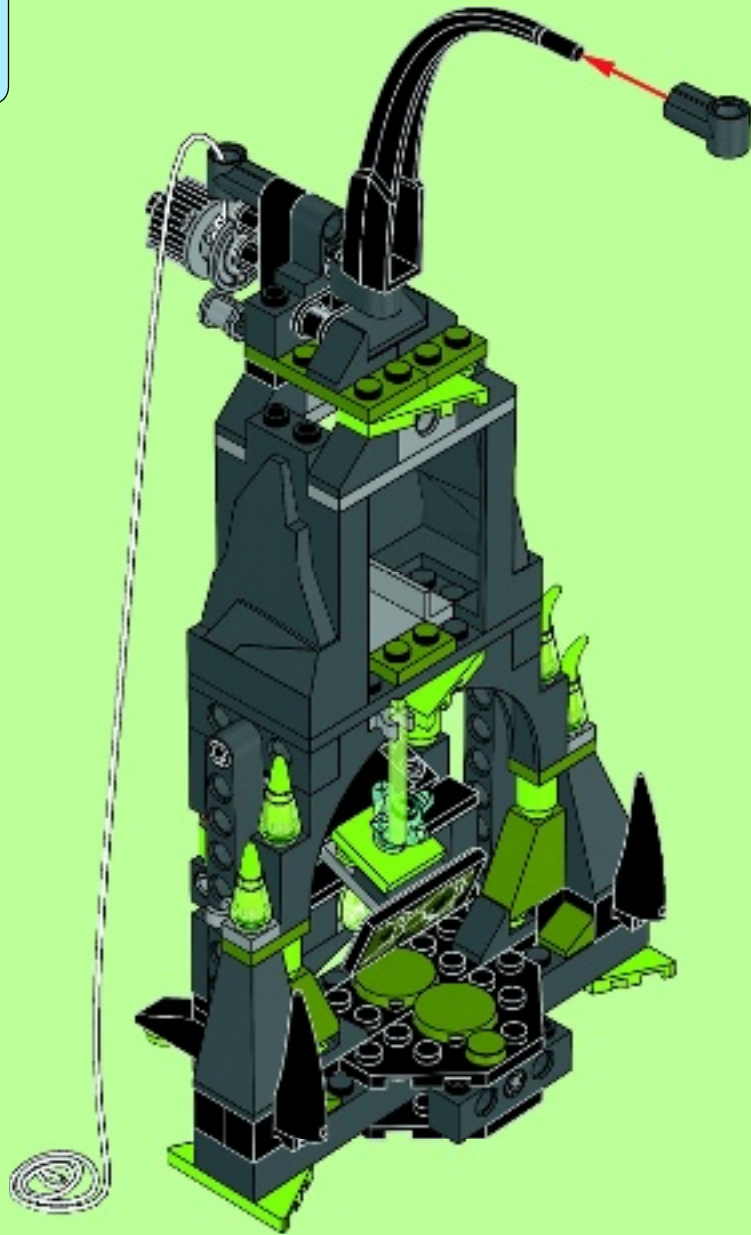



1x

42

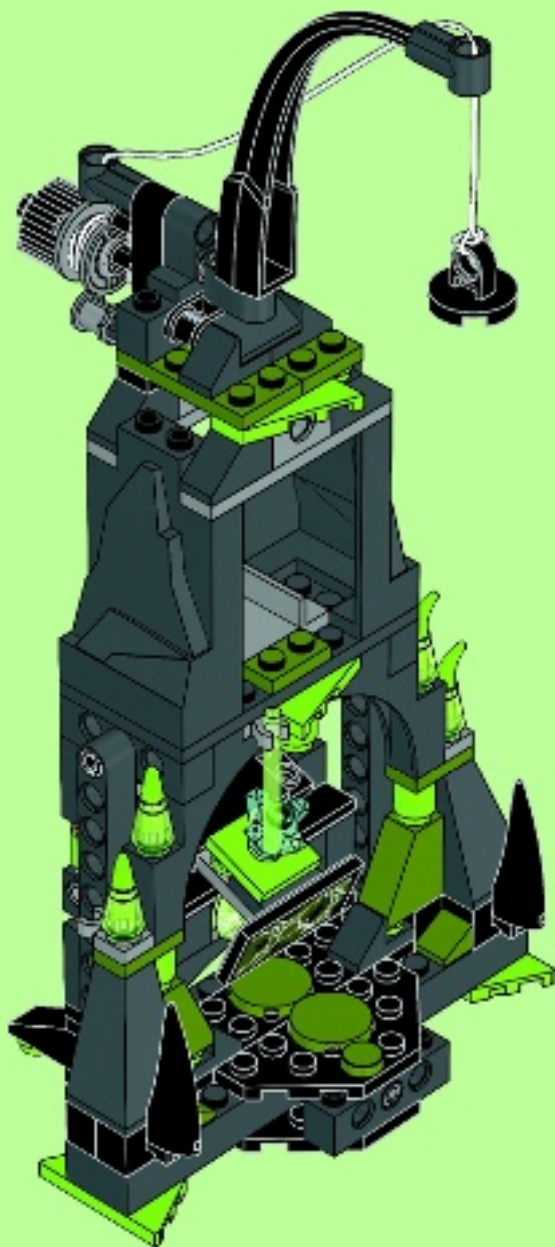

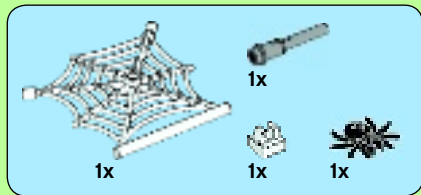

43

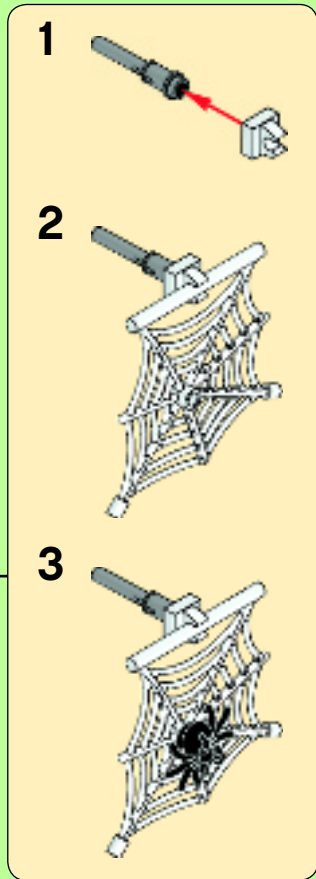
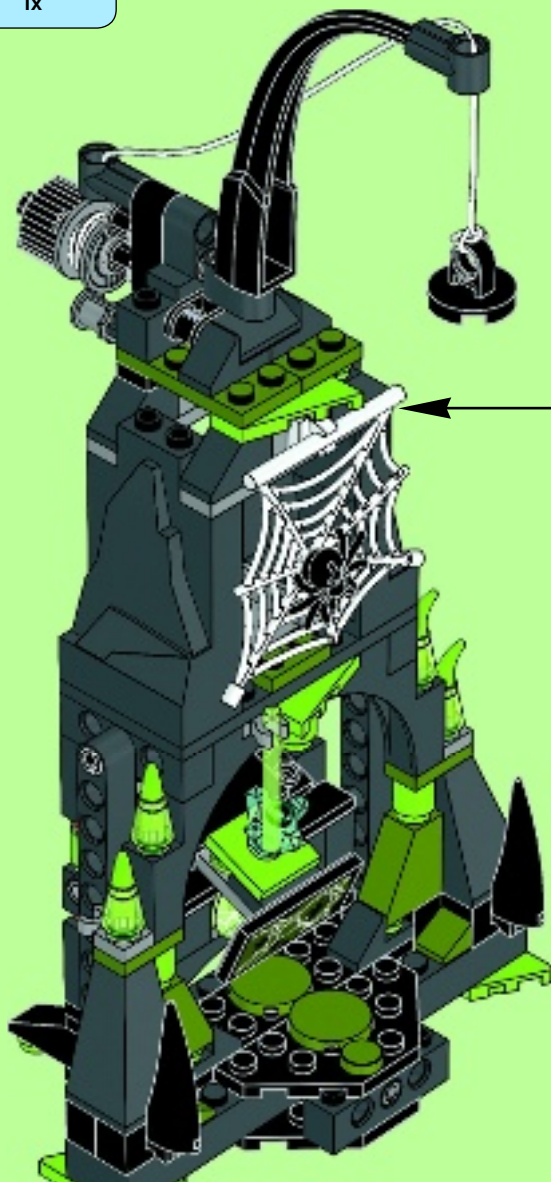

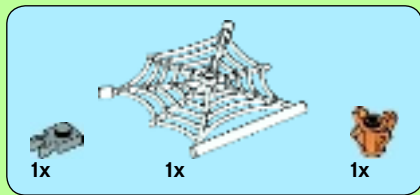

44

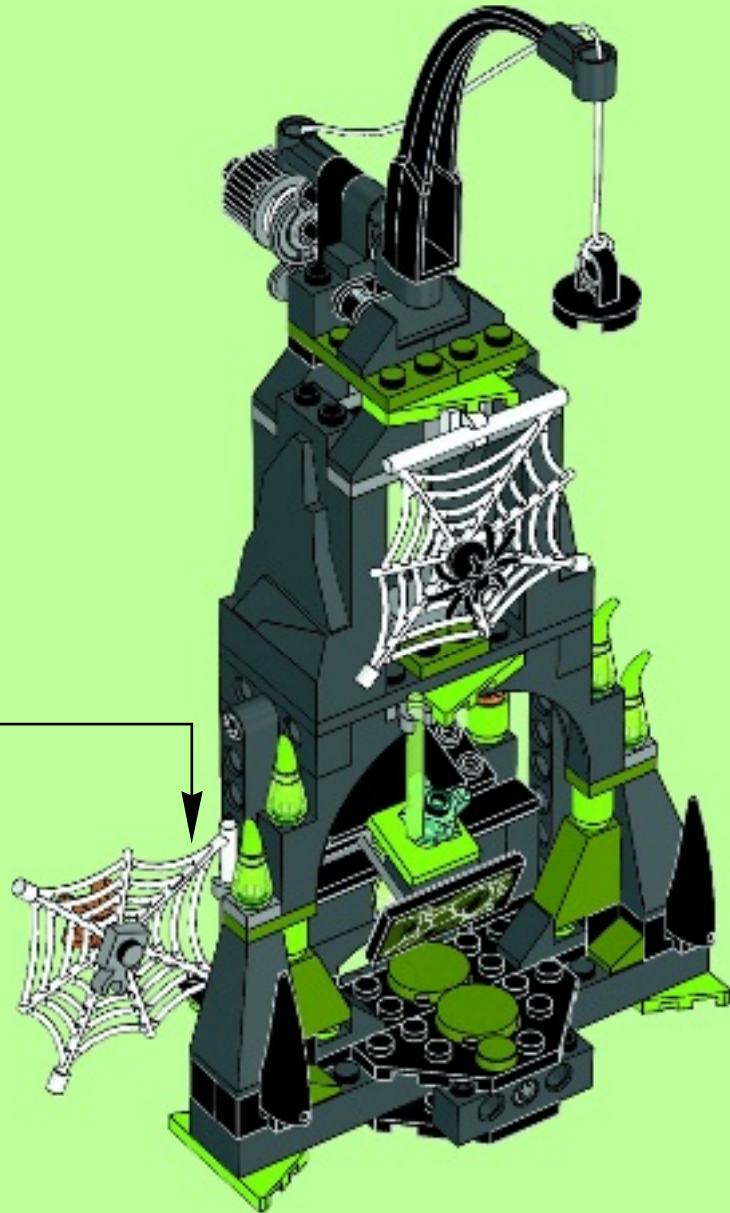
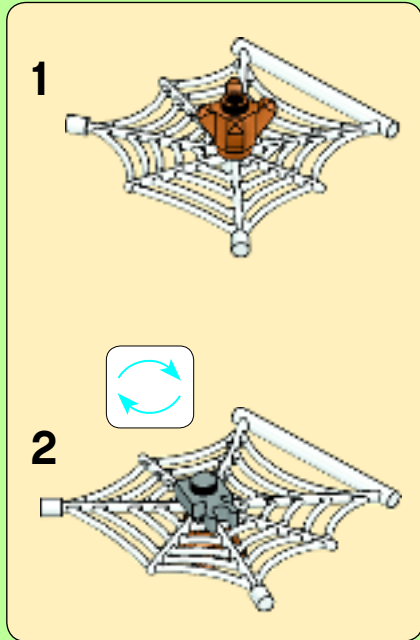

45

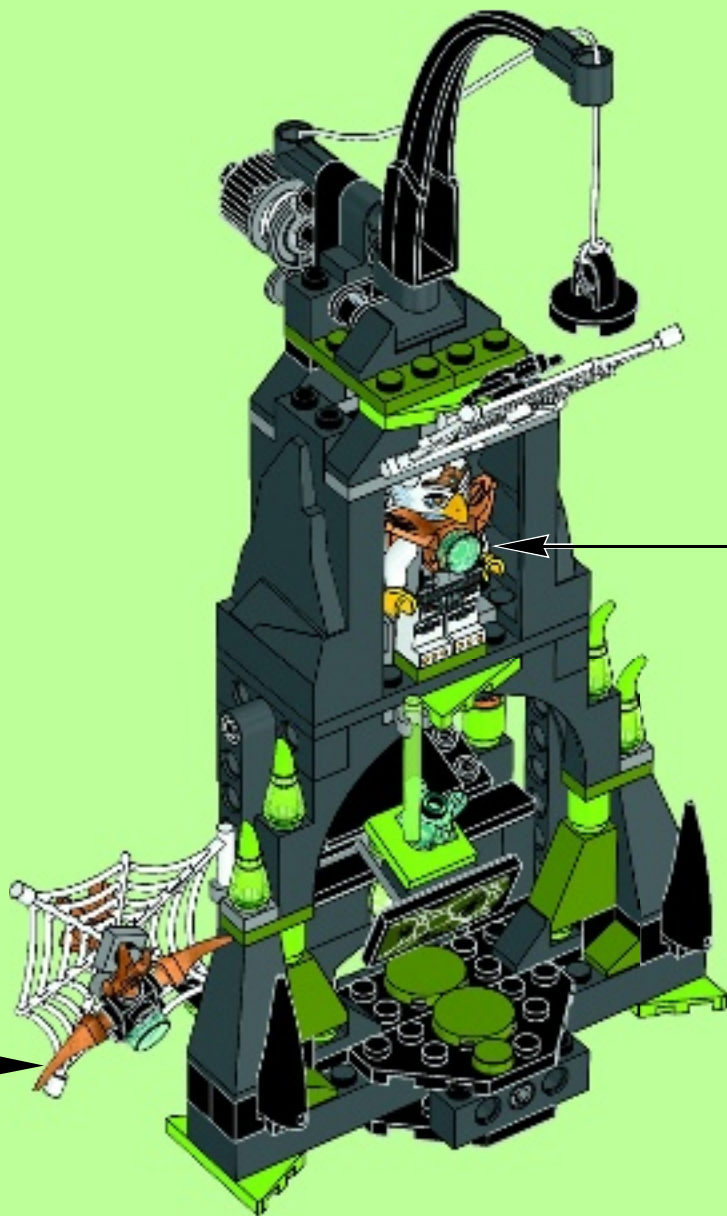

46

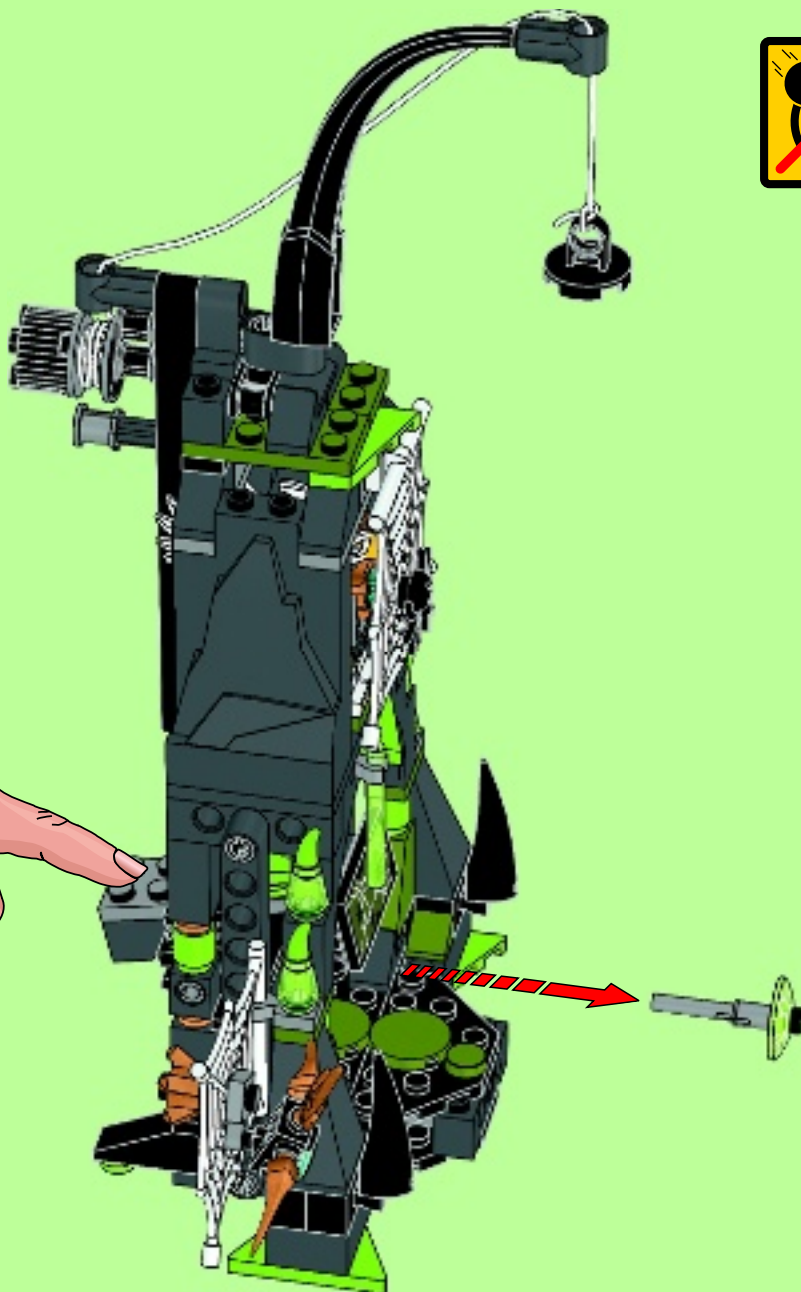
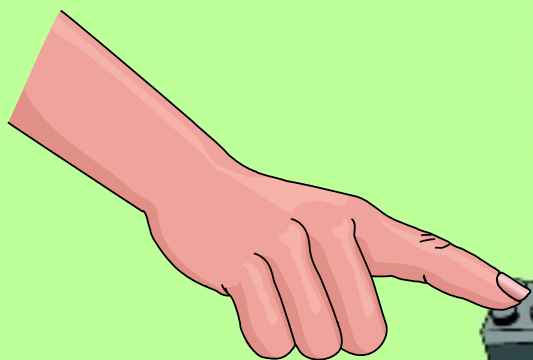

47

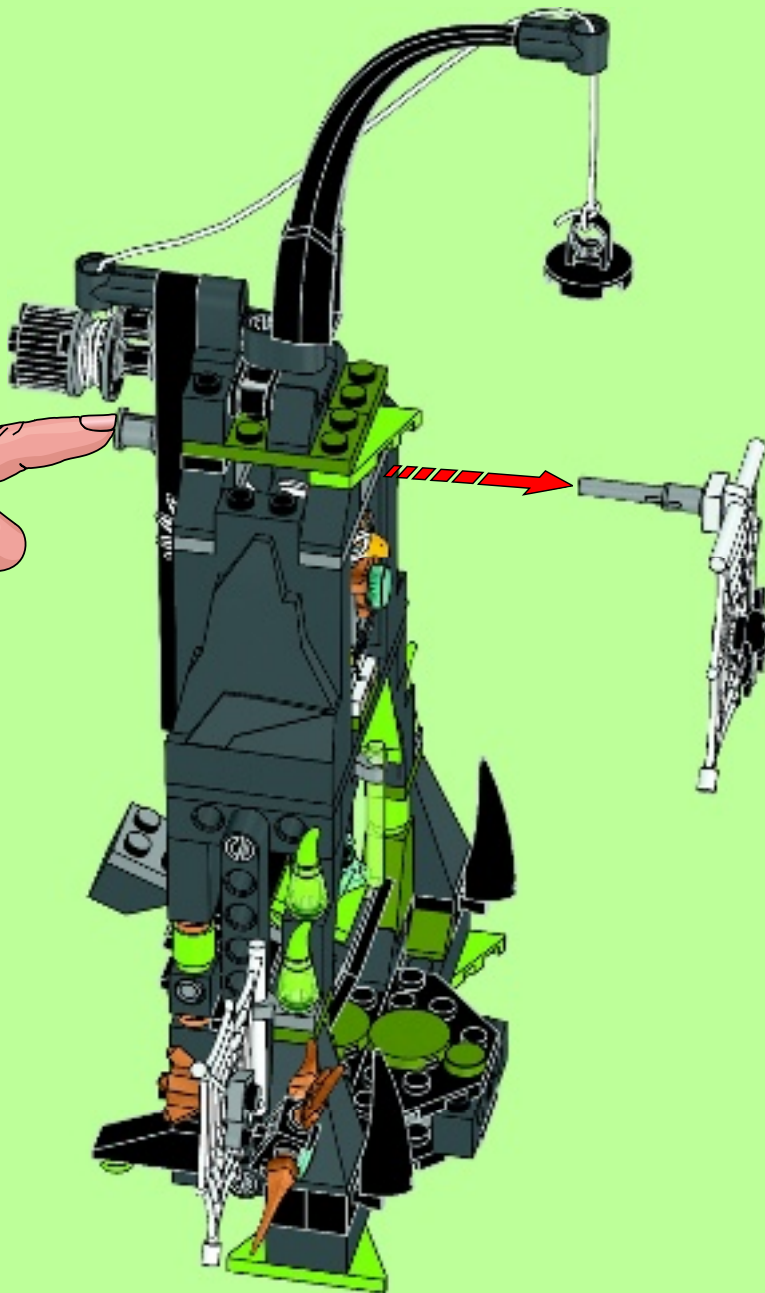

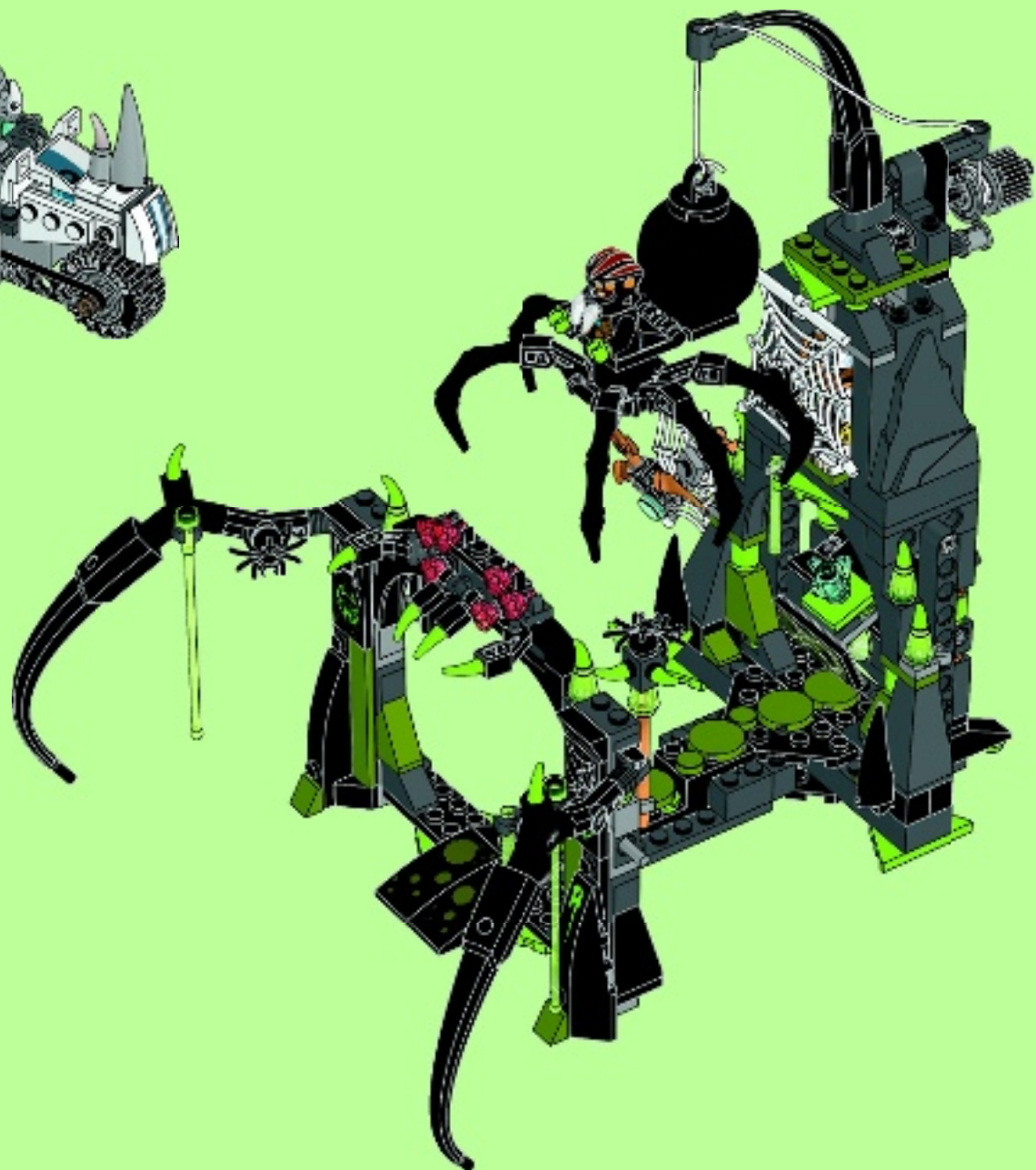
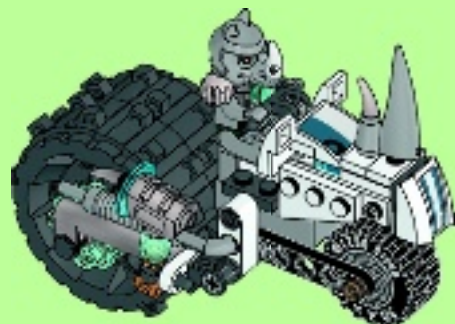







Customer Service
 Kundenservice
 Service Consommateurs
 Servicio Al Consumidor
 LEGO.com/service or dial

00800 5346 5555 : 
 1-800-422-5346 : 

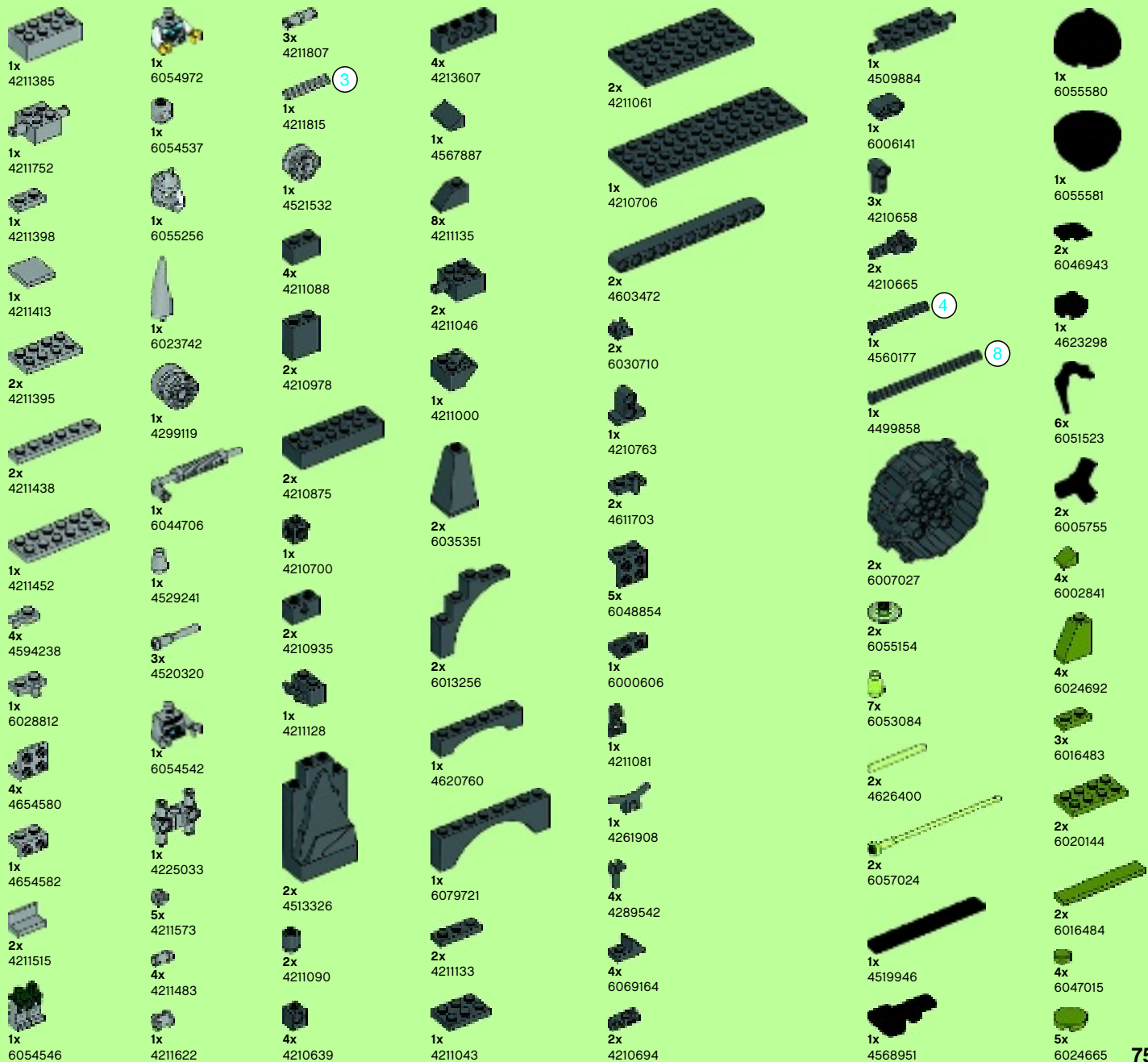



LEGENDS OF
CHIMA™



LAVAL

70132 70134



LAVERTUS

70129 70134



SHADOWWIND

70140



ERIS

70128 70133
70139



RINONA

70131



ROGON

70131 70133



CRAGGER

70132



GORZAN

70130 70136



SCORM

70132



SCUTTER

70129



SCOLDER

70140



BRAPTOR

70128



SPARACON

70131



SPARRATUS

70130 70138
70134



SPINLYN

70133



BLISTA

70134 70137



LEGENDS OF

CHIMA™

70129

70130

70124

70137

70131

70132

LEGO.COM/CHIMA





70132



70131



70130



70129



70128



70127



70126



70125



70124



70123



70140



70139



70138



70137



70136



LEGENDS OF

CHIMA™

TM

LEGO.COM/CHIMA

JOIN THE QUEST!

DAS ABENTEUER ERWARTET DICH!
REJOINS LA QUETE!
¡PARTICIPA EN LA AVENTURA!
JUNTA-TE A MISSÃO!
SEGITS TE IS A KERESÉSBEN!



SCAN

SCANNEN · SCANNE
ESCANEA · FAZ SCAN
OLVASD BE



[http://www.lego.com/
Quest555](http://www.lego.com/Quest555)



WATCH

ANSEHEN · REGARDER
MIRA · VÊ · NÉZD MEG



LEGENDS OF

CHIMA



LEGO.COM/CHIMA



club™

Free*! Gratuit!

* Paid subscription in Australia and New Zealand.
Abonnement payant en Australie et Nouvelle-Zélande



© 2014 The LEGO Group.



LEGO.com/club



WIN!

Go to LEGO.com/productfeedback to fill out a survey for a chance to win a cool LEGO® Product. No purchase necessary. Open to all residents where not prohibited.



LEGO.com/productfeedback

GEWINNE! WIN!

Nimm an der Umfrage auf LEGO.com/productfeedback teil und hab die Chance ein cooles LEGO® Produkt zu gewinnen!

Die Teilnahme am Gewinnspiel führt zu keinerlei Kaufverpflichtungen. Teilnahme in allen nicht ausgeschlossenen Ländern möglich.

Ga naar LEGO.com/productfeedback, vul een enquêteformulier in en maak kans op een cool LEGO® product.

Geen aankoopverplichting. Ledereen mag deelnemen, uitgezonderd ingezetenden van landen waar een enquêteverbod geldt.

GAGNE! 当てよう!

Visite LEGO.com/productfeedback pour répondre à un questionnaire et avoir une chance de gagner un produit LEGO® très cool!

Aucune obligation d'achat. Ouvert à tous les résidents des pays autorisés.

LEGO.com/productfeedback にアクセスして、アンケートにご記入ください。当選者にはレゴ® 製品を差し上げます。

お買い上げの必要はありません

禁止されていない限り、すべての皆様にご利用いただけます。

 LEGO.com

6102551

LEGO, the LEGO logo and LEGENDS OF CHIMA are trademarks of the LEGO Group. ©2014 The LEGO Group.