



# BRICK 'HEADZ

41636



THE  
**LEGO**  
MOVIE

BENNY

90





 [LEGO.com/movie2](http://LEGO.com/movie2)



70823 70829 70830 70831



THE LEGO® MOVIE 2™ © & ™, Warner Bros. Entertainment Inc. & The LEGO Group. LEGO, the LEGO logo, DUPLO, the Minifigure and the Brick and Knob configurations are trademarks and/or copyrights of the LEGO Group. ©2019 The LEGO Group. All rights reserved. WB SHIELD: TM & © WBEI. (s19)



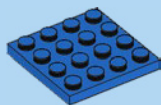

1x

1

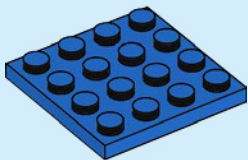

4



2x



1x

2

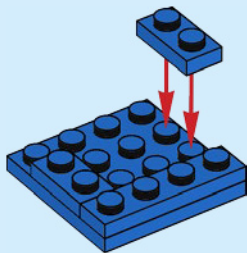

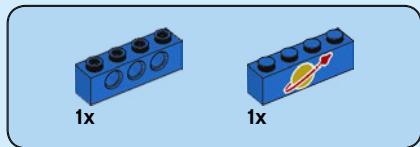

**3**

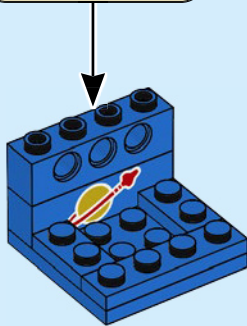
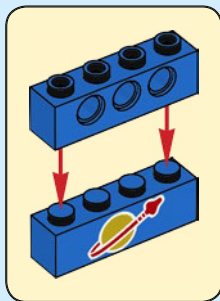



2x

4

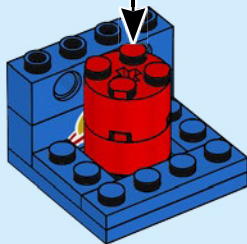
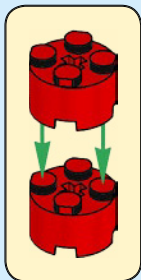

6



2x

5

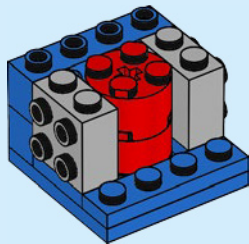

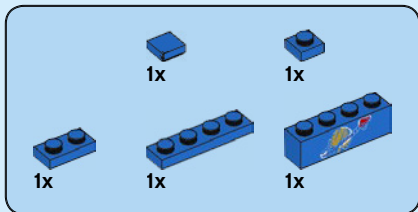

6

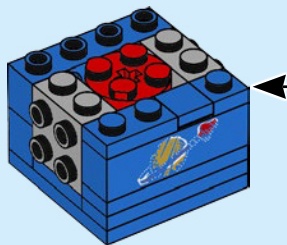
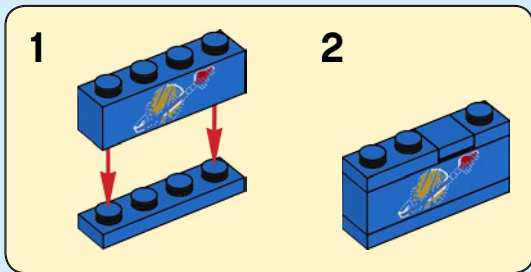

8



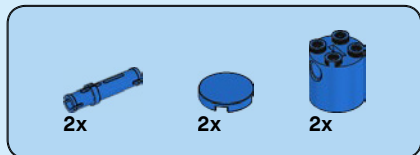

7

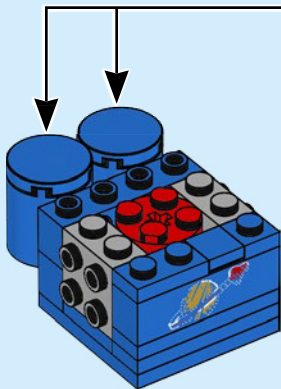
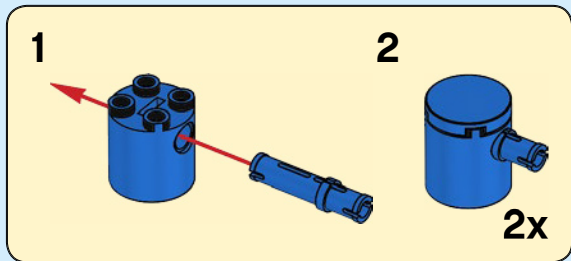

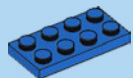

1x



2x



1x

8

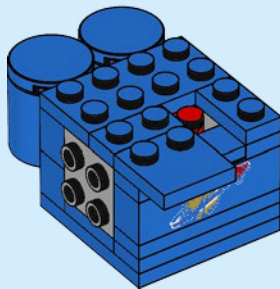

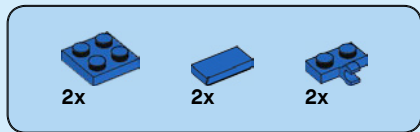

9

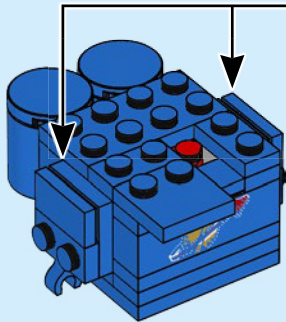
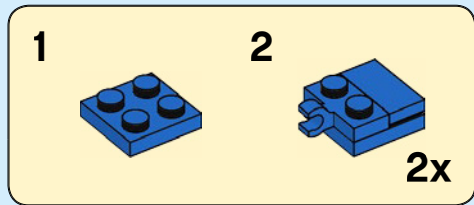



2x



1x

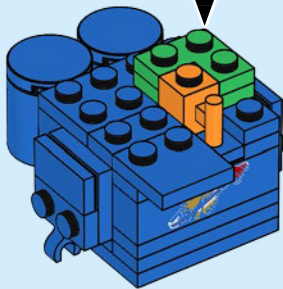
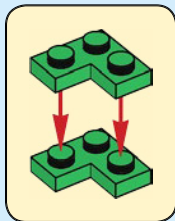

10

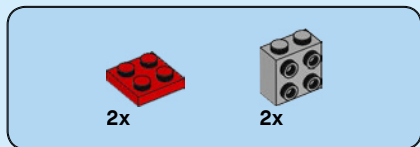

11

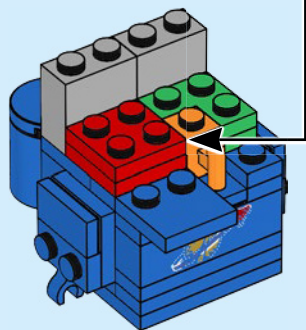
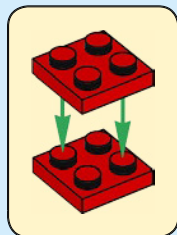



1x



1x



1x

# 12

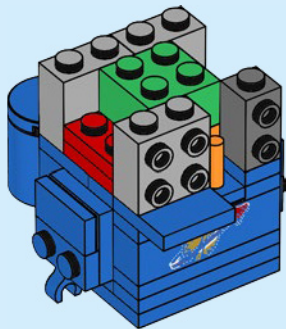



2x

13

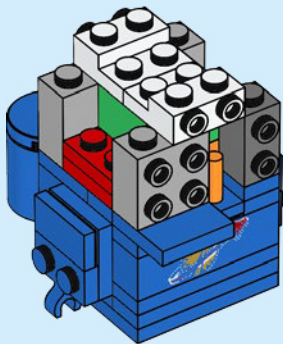

1x



2x

14

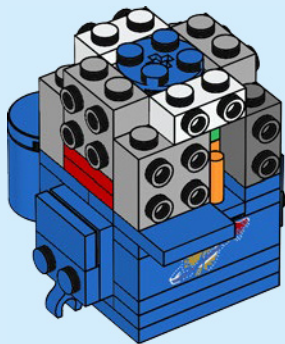



8x

15



4x

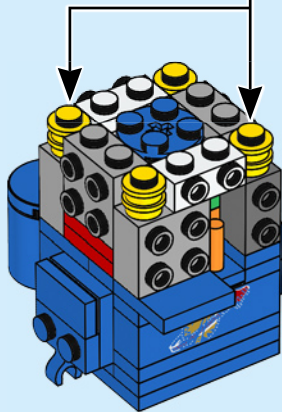

16





1x



4x

# 16

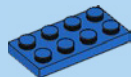
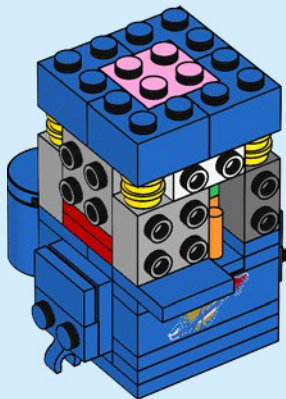

1x



2x

# 17

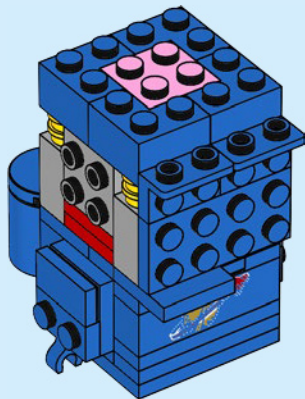

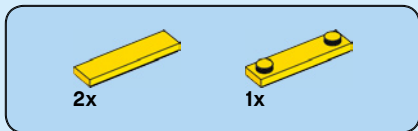

18

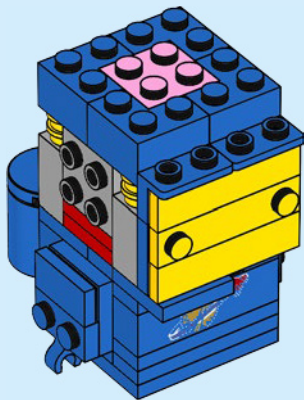

18



19

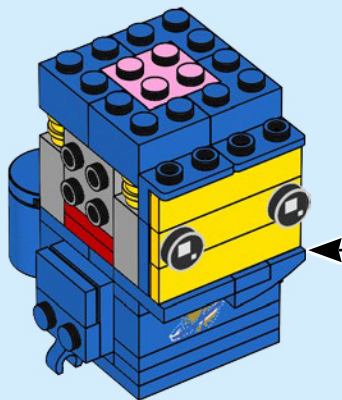
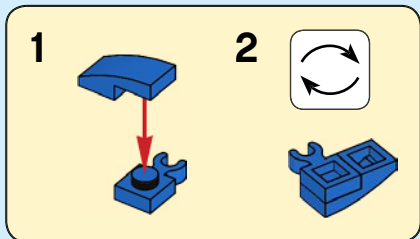



1x



2x

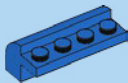

1x

# 20

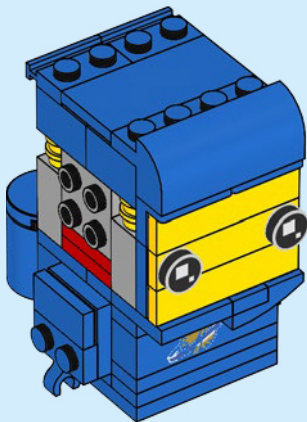

20

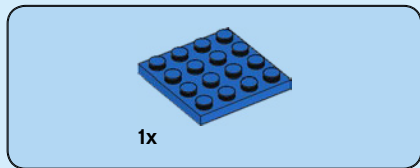

21

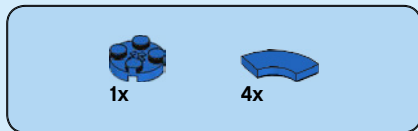
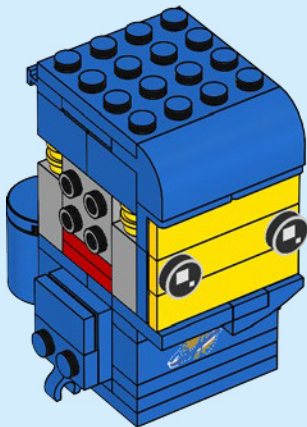

22

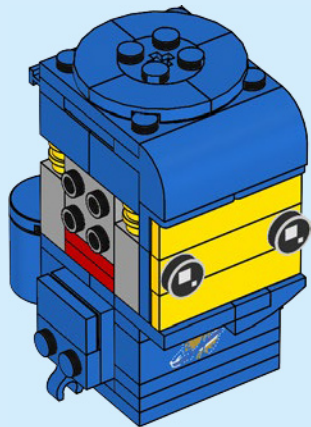

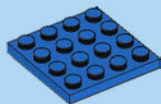

1x

23

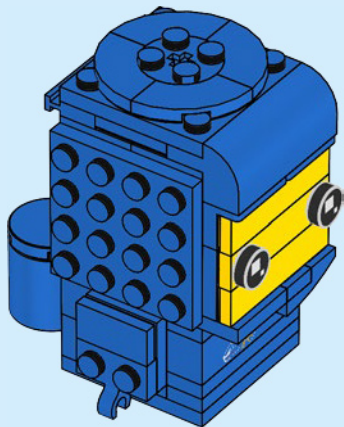

22

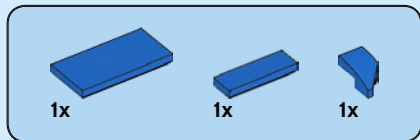

24

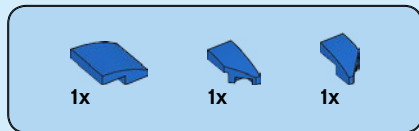
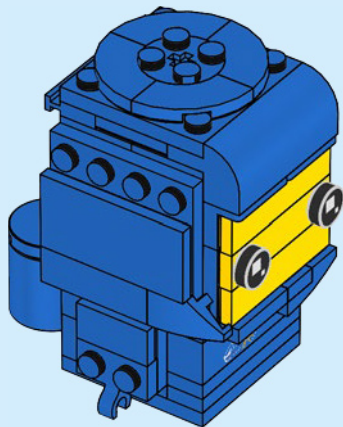

25

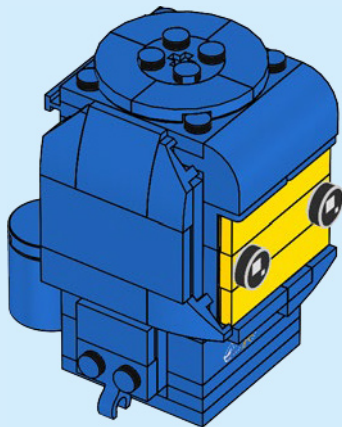

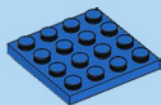

1x

26

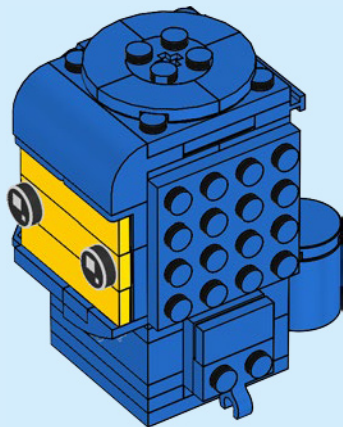
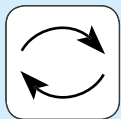

24



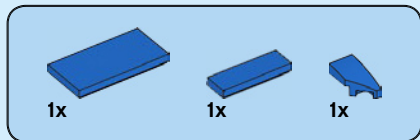

27

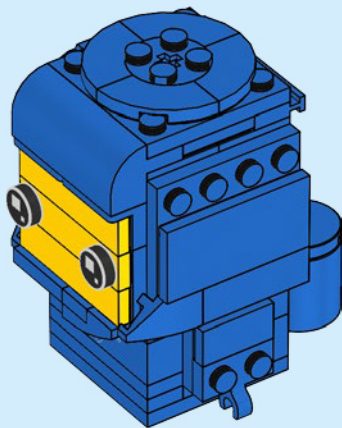

28

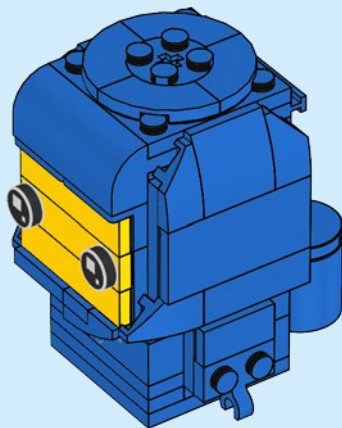

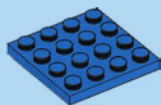

1x

29

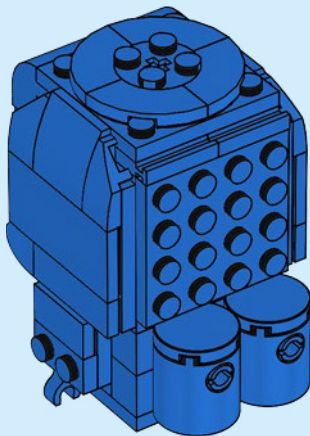
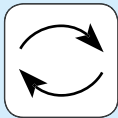

26

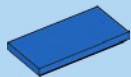

2x

**30**

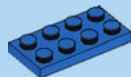
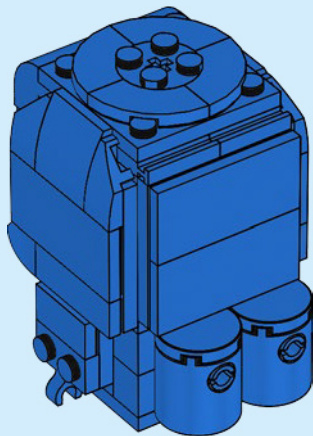

1x

**31**

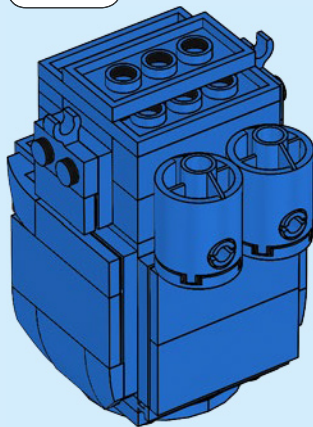
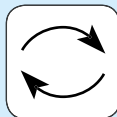



2x

32

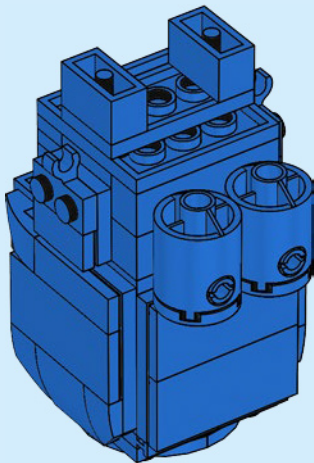

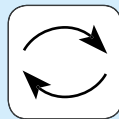
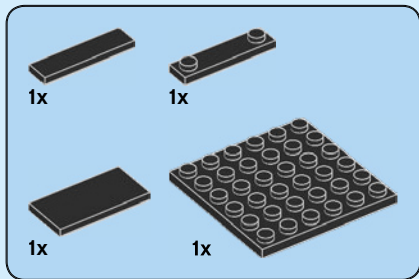

**33**

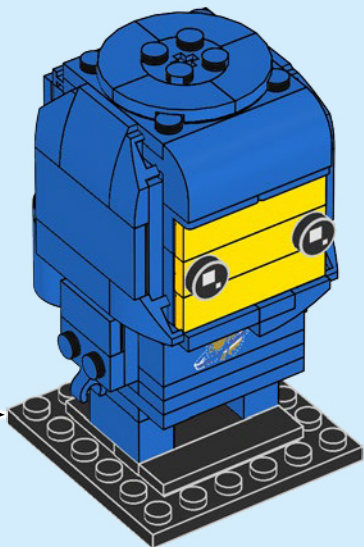
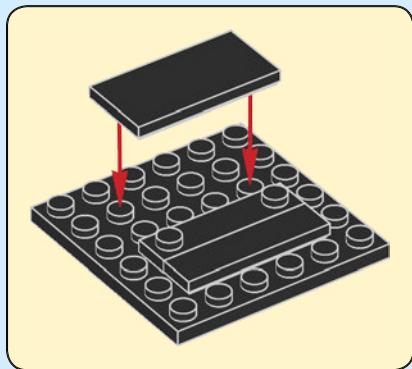

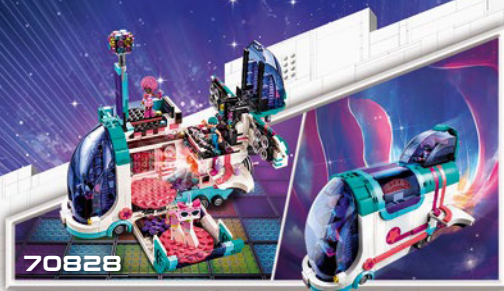

70828



70831



70830



70826

 [LEGO.com/movie2](http://LEGO.com/movie2)



70826    70830    70831    70828



THE LEGO® MOVIE 2™ © & ™, Warner Bros. Entertainment Inc. & The LEGO Group. LEGO, the LEGO logo, DUPLO, the Minifigure and the Brick and Knob configurations are trademarks and/or copyrights of the LEGO Group. ©2019 The LEGO Group. All rights reserved. WB SHIELD: TM & © WBEI. (s19)





1x  
6228923



7x  
6123809



2x  
6178627



1x  
6254045



1x  
243126



1x  
4560182

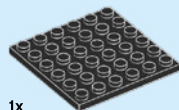

1x  
395826



2x  
371023



1x  
6267134



1x  
6267126



5x  
4560180



3x  
302023



1x  
6268011

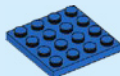

5x  
4243815



1x  
6252060



2x  
6116786



4x  
4558606



4x  
6194724



2x  
4514553



2x  
4587840



2x  
6159841



1x  
370123



2x  
6213381



2x  
300423



1x  
6055065



5x  
302323



2x  
6133721



2x  
6179330



2x  
302223



1x  
4206330



1x  
4613257



3x  
6172411



2x  
403223



2x  
6133844



2x  
306923



1x  
300328



2x  
4157120



1x  
302423



3x  
6172414



8x  
614124



2x  
243124



1x  
6257598



1x  
4550359



1x  
6170571



2x  
6046979



2x  
614321



2x  
302221



**Customer Service**

**Kundenservice**

**Service Consommateurs**

**Servicio Al Consumidor**

**LEGO.com/service or dial**



**: 00800 5346 5555**

**: 1-800-422-5346**

# WIN

GO TO [WWW.LEGO.COM/PRODUCTFEEDBACK](http://WWW.LEGO.COM/PRODUCTFEEDBACK) AND  
GIVE US YOUR SHORT **FEEDBACK** ABOUT THIS  
LEGO® SET FOR A CHANCE TO WIN  
A COOL LEGO PRIZE.

Terms & Conditions apply

## LEGO.com/productfeedback



### GEWINNE

Erzähle uns auf  
[www.LEGO.com/productfeedback](http://www.LEGO.com/productfeedback)

etwas über die Erfahrungen, die du  
mit diesem LEGO® Set gemacht hast,  
und sichere dir die Chance auf einen  
coolen LEGO Preis!

Es gelten die Teilnahmebedingungen

### GAGNE

Rends-toi sur  
[www.LEGO.com/productfeedback](http://www.LEGO.com/productfeedback)

et donne-nous quelques commen-  
taires sur ce produit LEGO® pour  
avoir une chance de gagner un  
prix LEGO !

Voir Conditions Générales

### GANA

Visita  
[www.LEGO.com/productfeedback](http://www.LEGO.com/productfeedback)

y envíanos tu opinión acerca de este  
set LEGO®. ¡Participarás en el sorteo  
de un premio LEGO!

Términos y Condiciones aplicables

### 获取奖品

登录  
[www.LEGO.com/productfeedback](http://www.LEGO.com/productfeedback)

给出关于此乐高®套装的简短反馈，  
就有机会获得炫酷乐高奖品

《条款及条件》适用

THE LEGO® MOVIE 2™ © & TM Warner Bros. Ent. Inc. & The LEGO Group. LEGO, the LEGO logo, DUPLO,  
the Minifigure and the Brick and Knob configurations © & TM The LEGO Group. ©2019 The LEGO Group.  
WB SHIELD: TM & © WBEI. (s19)



6274775