

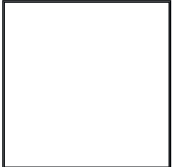

Booklet available in English on
Heft in deutscher Sprache erhältlich auf
Livret disponible en français sur
Libretto disponibile in italiano su
Folleto disponible en español en
如需中文版手册, 请访问

LEGO.com/service/buildinginstructions





STYLE MAKEOVER CLASS

*"Even if you're not
ready to live at
your full volume,
turn it up halfway,
and get there."*

- Bobby Berk

QUEER EYE

MORE THAN A MAKEOVER

While so many reality TV shows are about knocking people down, *Queer Eye* is all about building people up. The Fab Five use their own personal experiences – both positive and negative – to achieve a constructive and lasting impact for every single person, or heroes as the team prefers to call them, that they meet.

Join the Minifigure Fab Five in the LEGO® version of their original Atlanta loft. They're all here: fashion designer Tan France, culture expert Karamo Brown, food and wine specialist Antoni Porowski, interior designer Bobby Berk and grooming consultant Jonathan Van Ness, and they need your help to carry out their latest transformation. Enjoy!





"As a stylist, my goal is to help people be the best version of themselves."

- Tan France



TAN FRANCE

FASHION



Born in Doncaster, South Yorkshire, to Pakistani parents, Tan France started working in the US in 2008 and now lives in Salt Lake City, Utah.

As a clothes designer and fashion expert, Tan restores people's confidence in themselves by making them feel good about what they wear. More often than not, he completes every magical makeover with his signature French Tuck!



"Food can offer a moment of pure emotional pleasure in an otherwise hard and difficult world."

- Antoni Porowski

ANTONI POROWSKI

FOOD & WINE



As the son of Polish immigrants, Antoni grew up in Montreal, Canada, speaking Polish, English and French. After moving to the US, he studied psychology and theatre before turning his talents to cooking. Before joining the Fab Five and encouraging people to start cooking for themselves, he worked for Ted Allen, the food expert from the original *Queer Eye* that ran in the early 2000s.



KARAMO BROWN

CULTURE

Karamo Brown is the life coach and therapist of the group. He helps the show's heroes get to the core of understanding themselves, encouraging them to overcome the life-changing adversity they've faced. Born in Houston, Texas, of Jamaican and Cuban descent, Karamo now lives in Los Angeles with his two sons and is an active campaigner for the Black LGBT community.



"Life does not happen to you. Life responds to you."

- Karamo Brown





"When you're happy at home, it spills out into every other area of your life."

- Bobby Berk



BOBBY BERK

DESIGN

Bobby grew up in a small town in Missouri. In 2003, he moved to New York with just \$100 in his pocket. He worked his way up to become creative director for a home furnishing company before launching his own online store. On the Netflix show *Queer Eye*, Bobby revamps the living spaces of the heroes to help them transform their lives.

"How you take care of yourself is how the world sees you."
- Jonathan Van Ness



JONATHAN VAN NESS

GROOMING

As the enthusiastic cheerleader of the Fab Five team, Jonathan encourages the show's heroes to find some real "me-time" via their own personalised grooming and self-care moments. When not restyling hair on *Queer Eye*, Jonathan is the effusive host on a series of award-winning podcasts and a big fan of gymnastics and figure skating – it's even rumoured Jonathan himself has mastered both the toe loop and axel jump on the ice!





Bruley was the loveable French bulldog from seasons 3-4. He passed away in 2019 but is now immortalized in LEGO® form.



EVERY GUEST IS A HERO

Every hero on *Queer Eye* has a special story to tell. Some have faced the traumas of losing a loved one, overcome a serious medical condition, or faced rejection by their family. Others have given so much to others and their local communities that they've had little time to look after themselves. They are all heroes to the Fab Five – and all deserving of a transformation that will make their lives easier, healthier and happier.



THIS WEEK'S GUEST

It wouldn't be a proper *Queer Eye* LEGO® set unless someone was getting a magical makeover! Meet Kathi Dooley, a dedicated teacher who played a special

role in Jonathan's early life, supporting him with understanding and kindness. Now it's time for Jonathan and friends to repay the favour...

Kathi Dooley's
LEGO makeover



Before

After



Bobby's cool design skills started at an early age ... with a LEGO® set!



MORE THAN A MAKEOVER

ATRUE COLLABORATION!

This *Queer Eye* LEGO® set was the result of a true Fab Five-style collaboration between the LEGO design team and the show's own design guru, Bobby Berk. For Bobby it quickly became a passion project: *"LEGO played such an important part in my childhood. Clicking those little bricks together really sparked my imagination and creativity."* Matthew Ashton, LEGO Vice President of Design, saw the collaboration as the perfect partnership: *"We share so many values, like caring, learning, creativity and fun. While the Fab Five rebuild people's lives, we are on a mission to inspire kids and adults to get creative and be part of rebuilding a more positive world."*

The first task was to decide exactly what the set should be. The team quickly zeroed in on the original loft setting from the first season and together defined the model's floor plan and layout. For Matthew it was vital they captured as many details as possible: *"We wanted to replicate the furniture and include iconic details like the STYLE, TASTE, CLASS' sign. We also wanted to include a distinct zone for each of the guys and play up to each of the Fab Five's unique skills and contributions to the team."*

"Collaborating with the LEGO team was an absolute dream come true! It would be any kid's dream and now my reality."

- Bobby Berk



Bobby and Matthew in the initial stages of the design process.



CLICKING IT ALL TOGETHER

Just like it is for the Fab Five, teamwork is an essential part of developing a great LEGO® set. The other members of Matthew's LEGO Dream team were Senior Graphic Designer, Diego Sancho and Senior Element Designer, Ruth Kelly.

Diego had the important task of capturing the Fab 5's likeness in LEGO minifigure form, as well as designing all the decorations and stickers to bring the loft to life: *"I got the opportunity to do my personal take on the artwork for the loft, to add some nice Easter Eggs for the fans! I created a 'Yaaas Queen' print for the kitchen to celebrate the fun LGBTQ+ saying, and if you look closely at the unique brush-stroke art you will see it says FAB 5!"*

For Ruth the challenge was very different: *"We simply didn't have any existing wigs with a coif quite as voluminous as Tan's, so it was my job to sculpt a new one. We decided to mould the wig in shimmering silver plastic to really 'elevate' Tan's look!"*

Matthew is proud of the finished set and what the partnership stands for: *"The Fab Five have had such a positive impact on so many peoples' lives. We need to take time to celebrate kindness and this collaboration has been the perfect way to showcase that."*



Left to right:
Ruth Kelly, Senior Element Designer
Matthew Ashton, Vice President of Design
Diego Sancho, Senior Graphic Designer

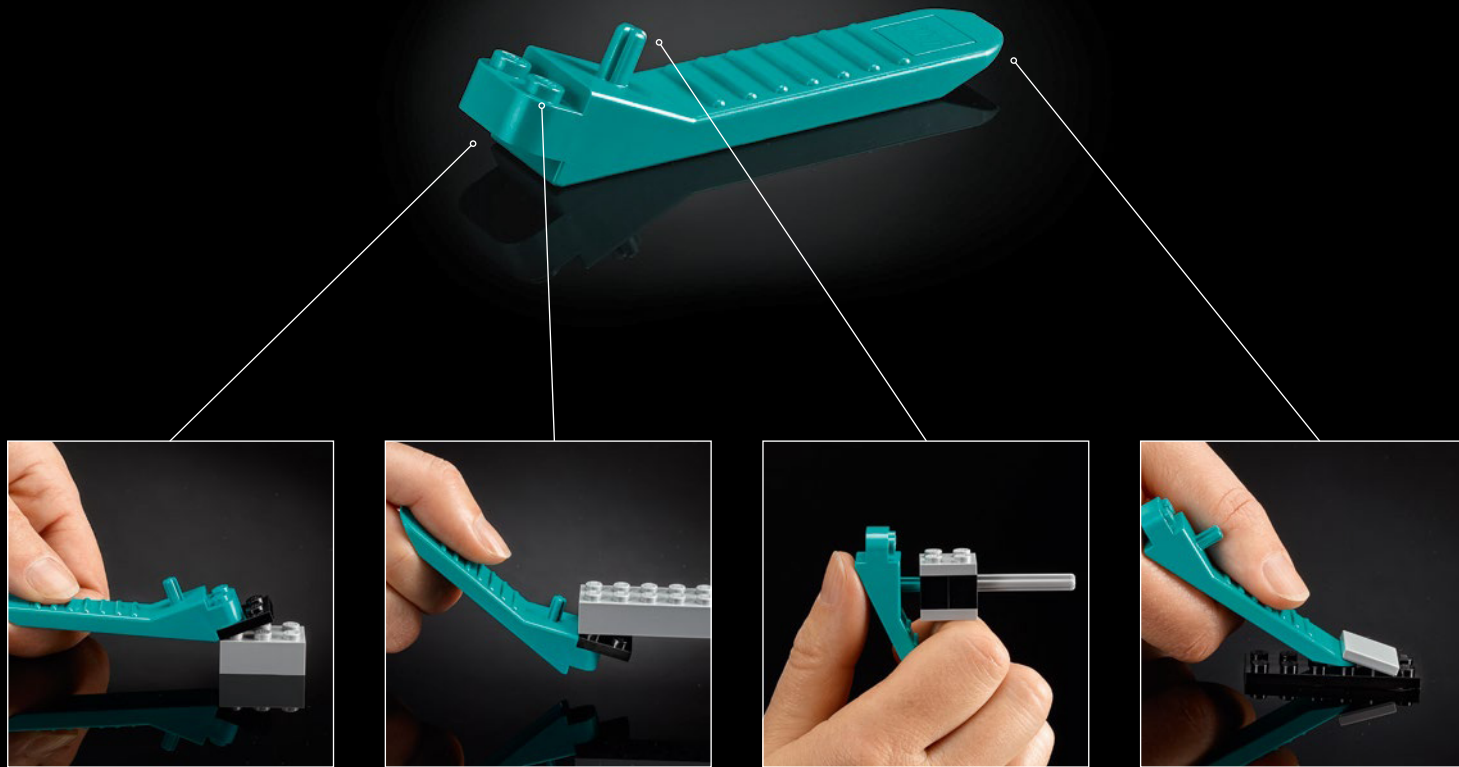

[LEGO.com/brickseparator](https://www.lego.com/brickseparator)

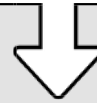
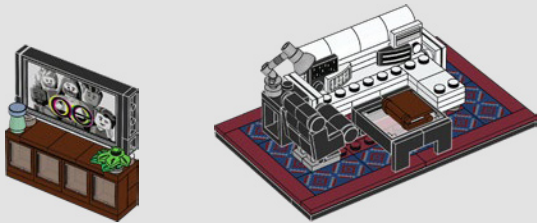
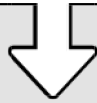

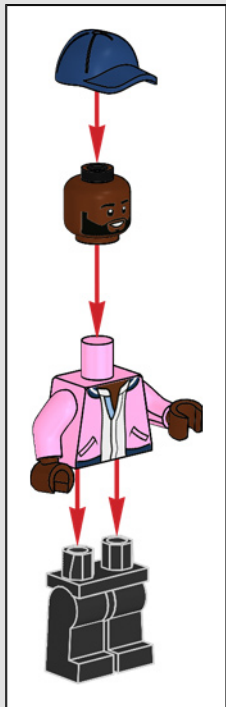
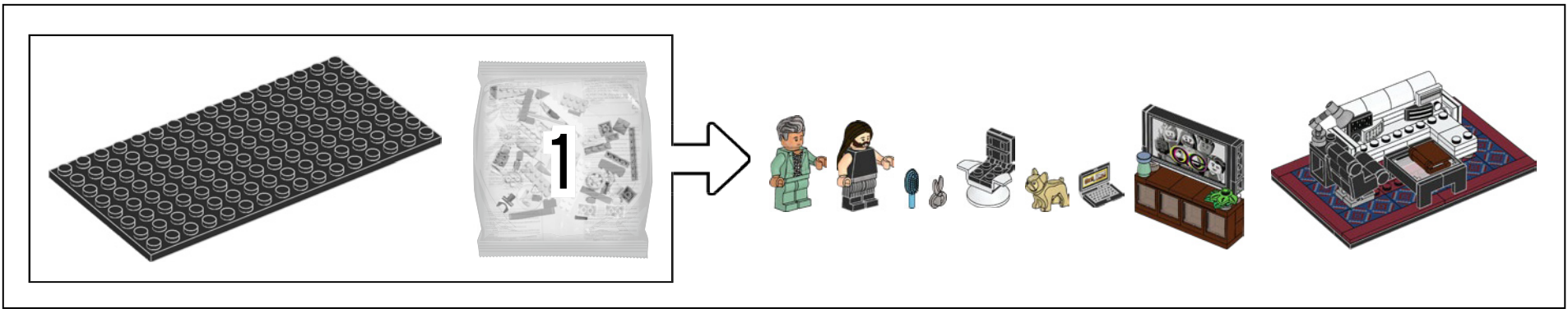

Karamo Brown

"Glad to see they made me rocking a signature Karamo bomber jacket, and good choice on the baseball cap to cover that unsightly bump on my head! Ha!"

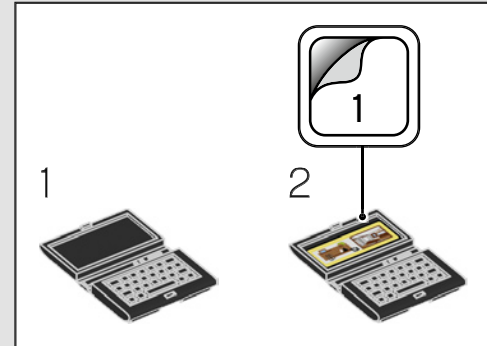

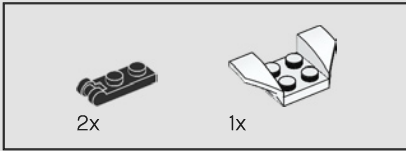
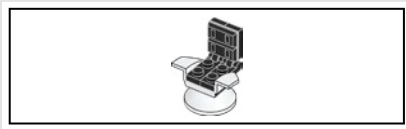

1

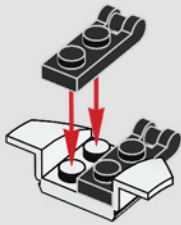

2

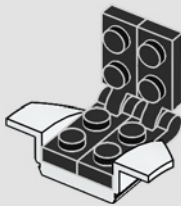

3

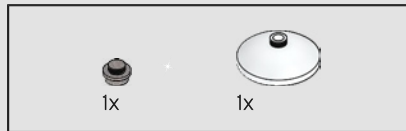
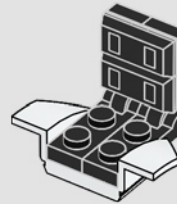

4

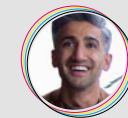
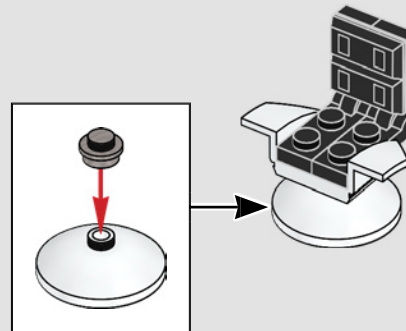

Tan France

"Ha! That little LEGO® wig is pure perfection! And much like my real hair once it is sprayed into place, it doesn't move an inch."



Jonathan Van Ness

"Could LEGO us be any cuter?!"

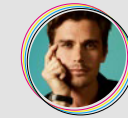

Antoni Porowski

"It's so cute that they included Bruley! I miss that little Pupponi!"

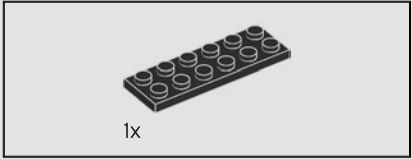
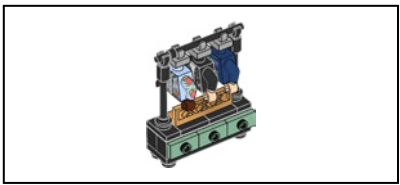

1

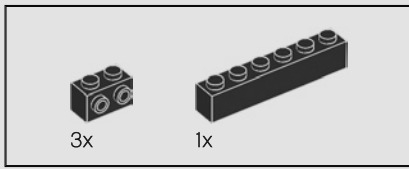
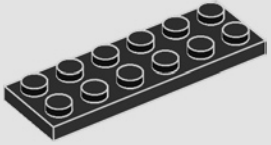

2

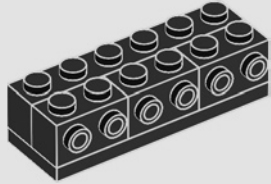

3

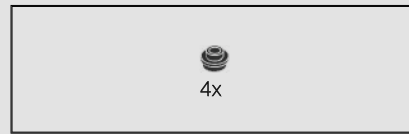
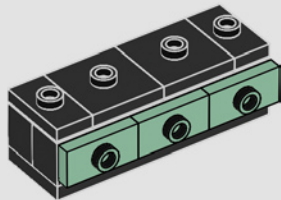

4

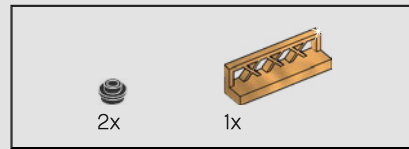
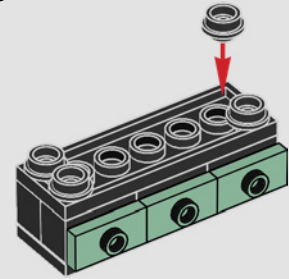
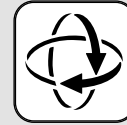

5

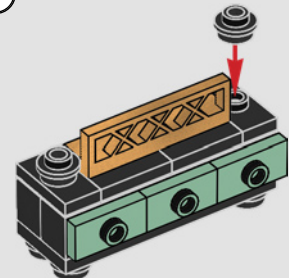
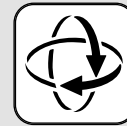



6

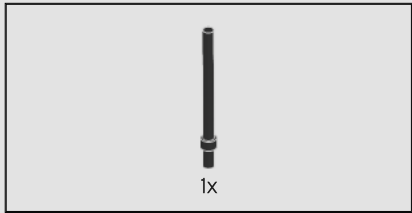
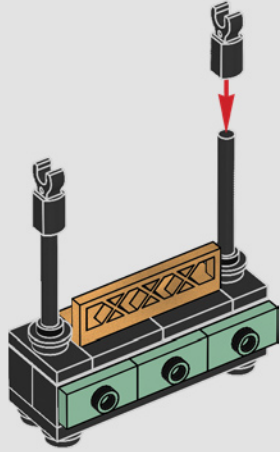

7

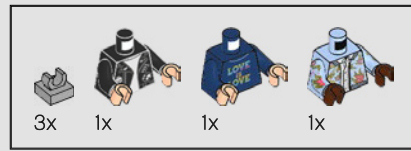
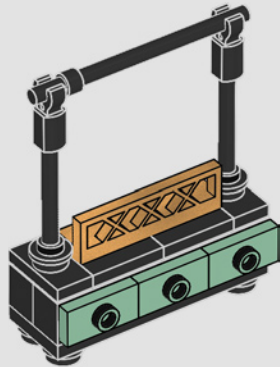

8

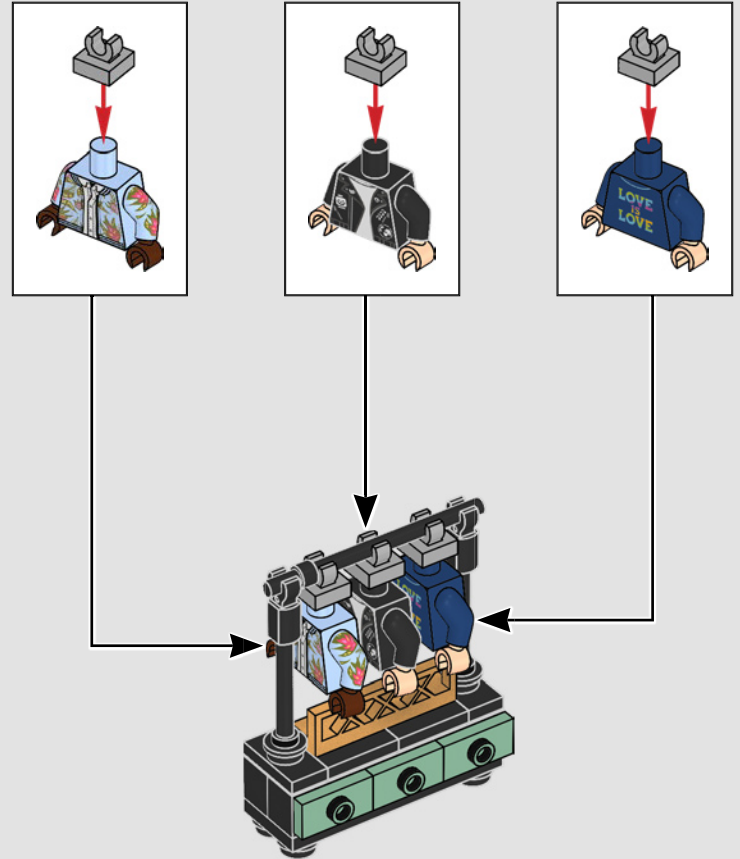

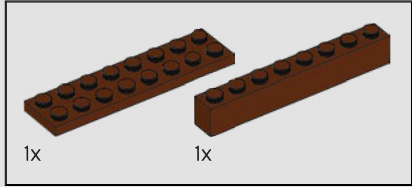

1

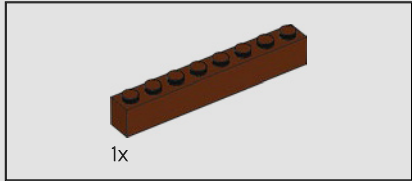
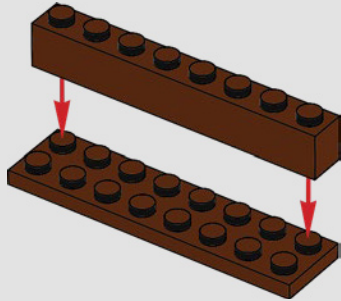

2

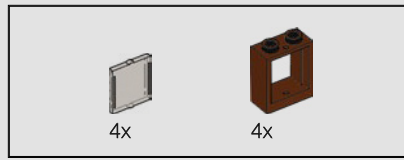
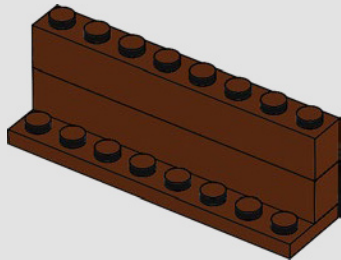

3

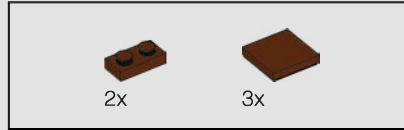
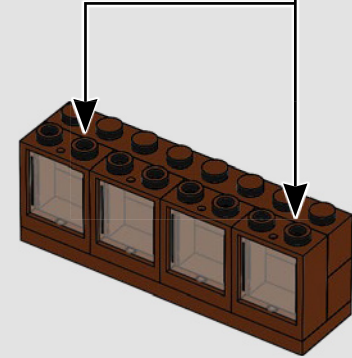
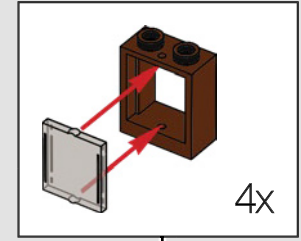

4

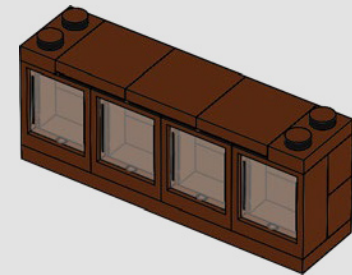



5

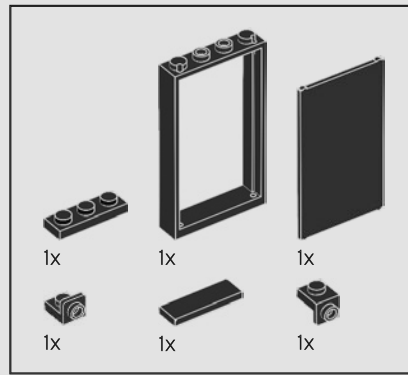
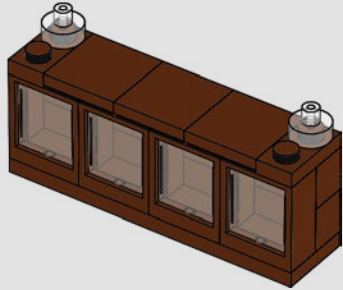

6

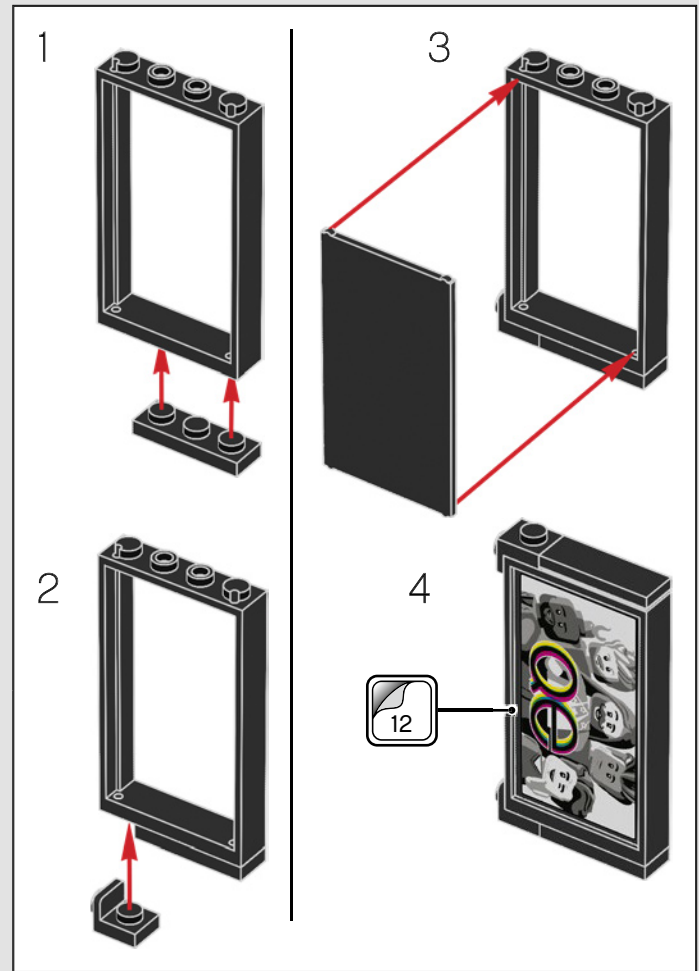
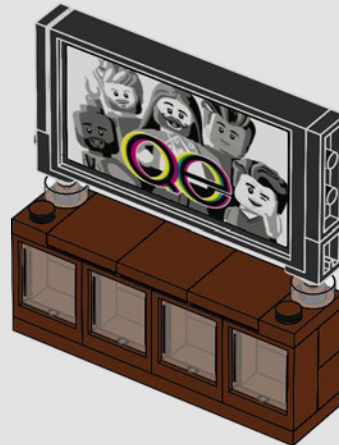



7



Jonathan Van Ness

"It's so important that folks have inclusion built into their creativity. So, for the LEGO Company to show support for topics like LGBTQ inclusivity feels necessary and I'm excited that it is happening."

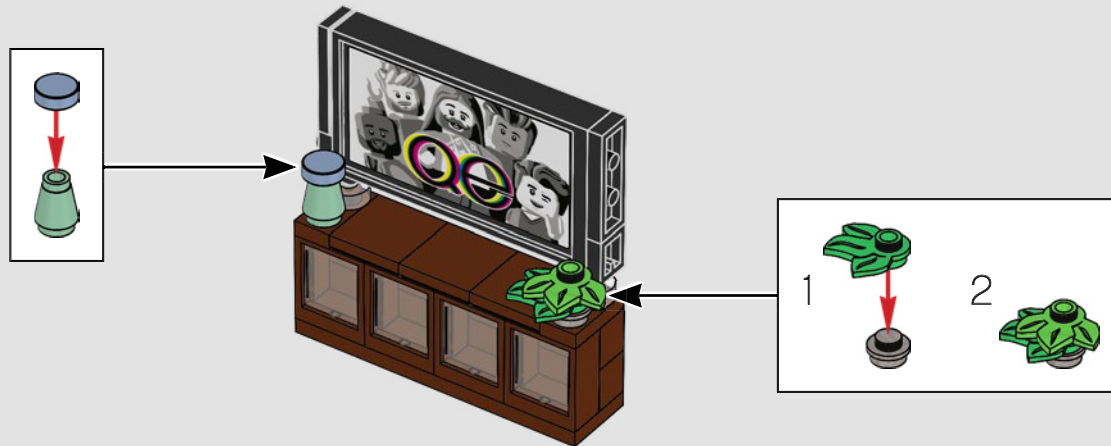

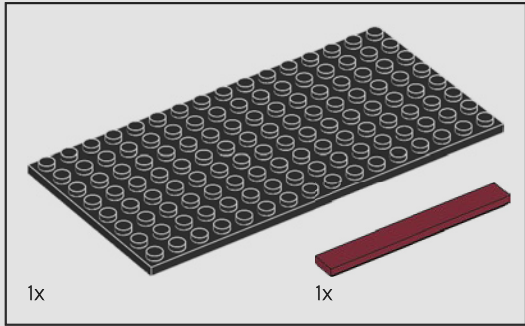
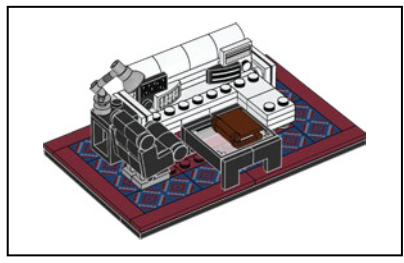

1

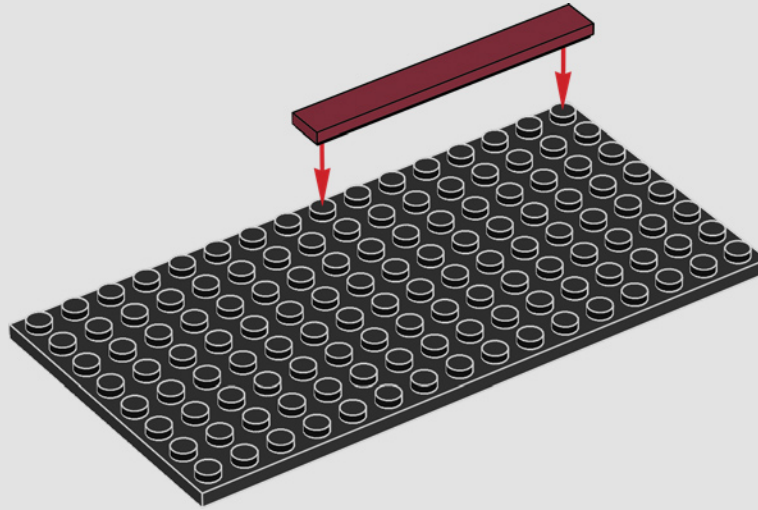

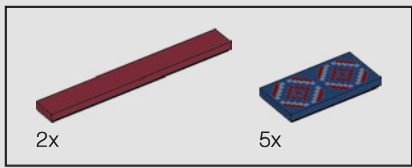

2

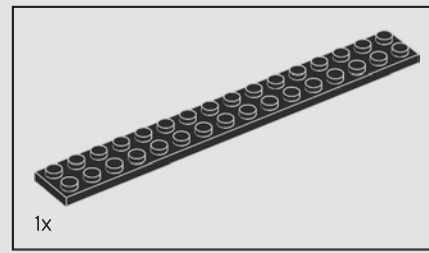
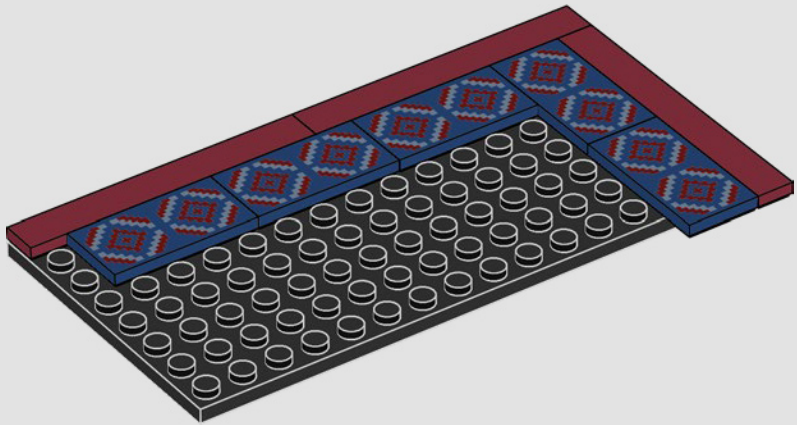

3

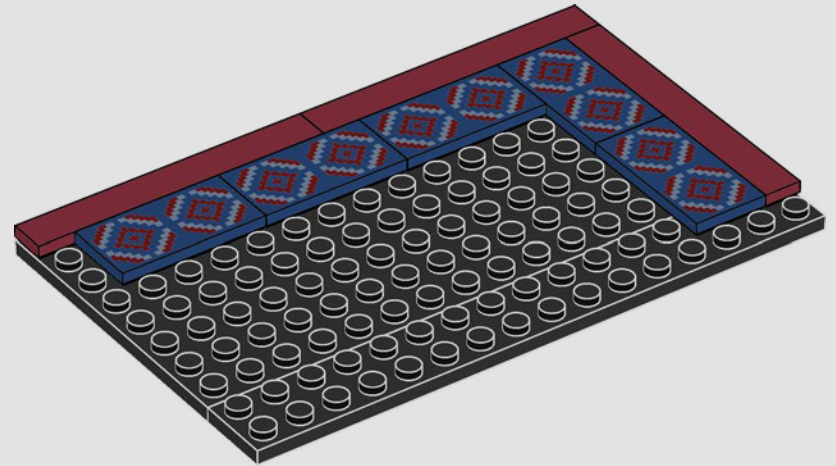

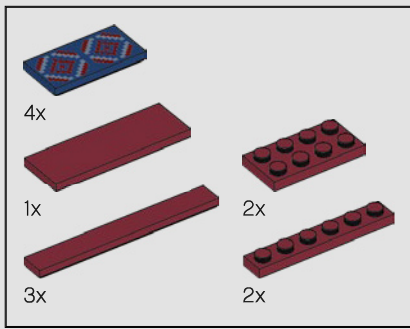

4

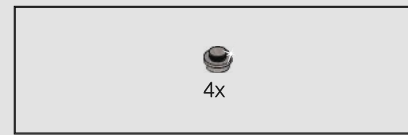
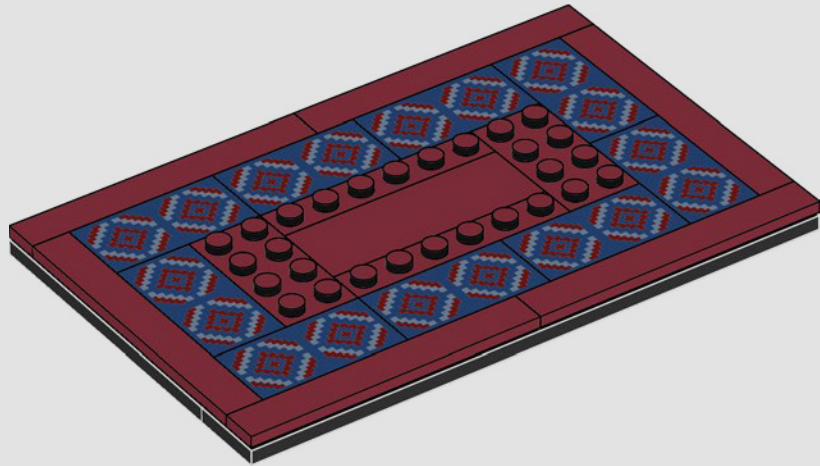

5

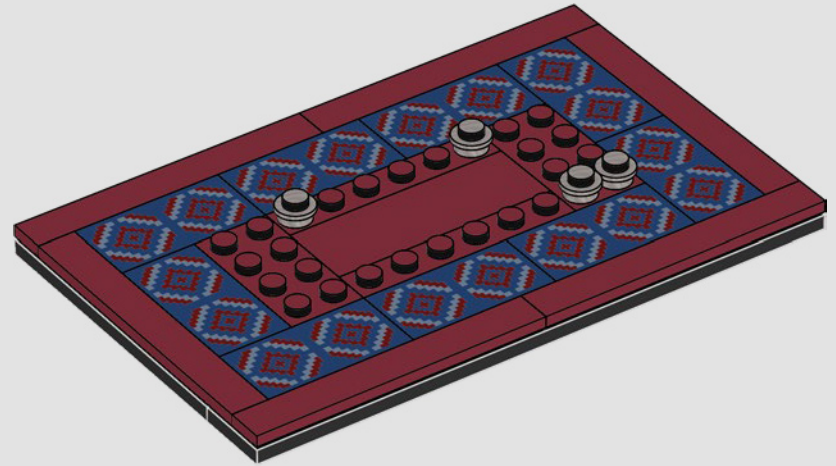

Jonathan Van Ness

"To be a part of the imagination of folks creating a better world is lovely! I hope folks can spark their imagination with this collaboration."

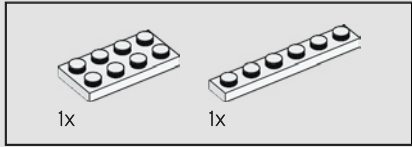
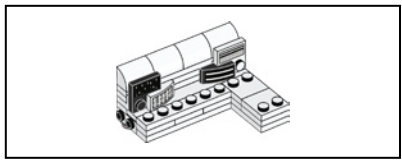

6

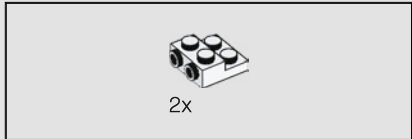
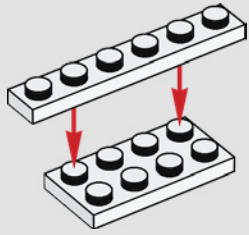

7

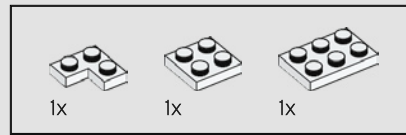
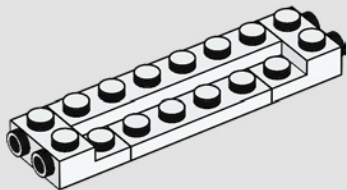

8

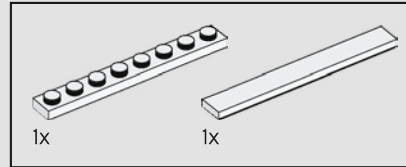
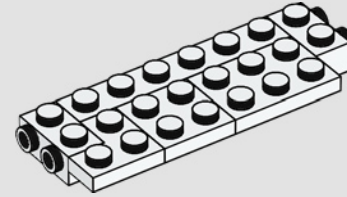

9

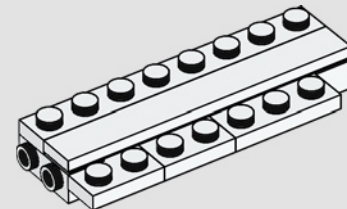

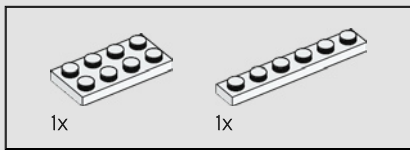

10

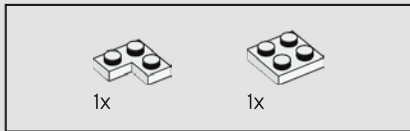
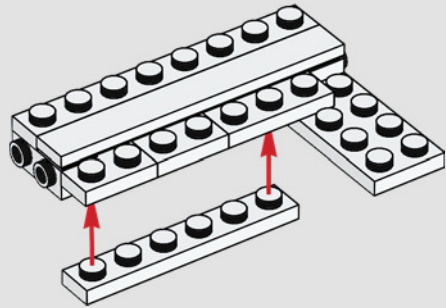

11

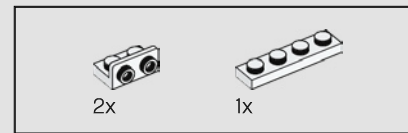
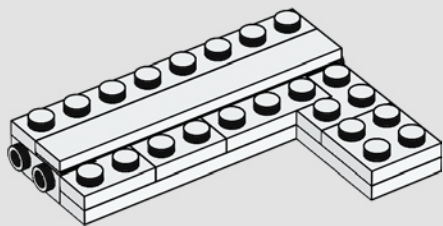

12

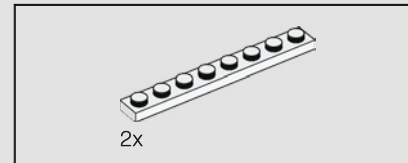
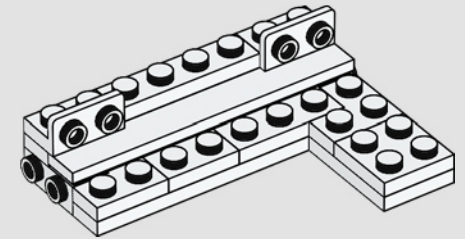

13

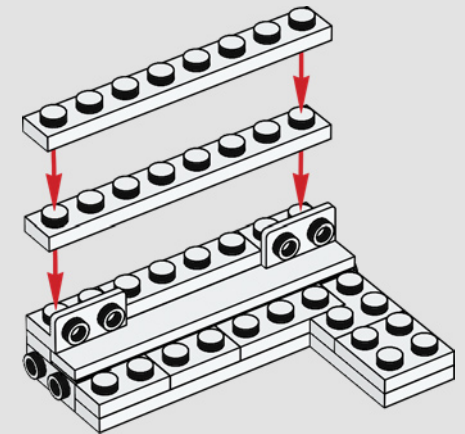

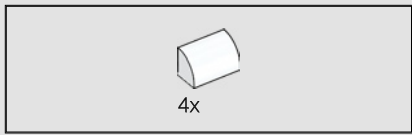

14

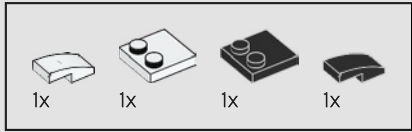
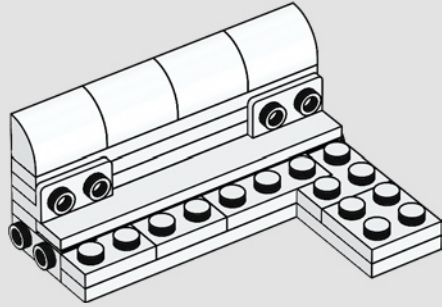

15

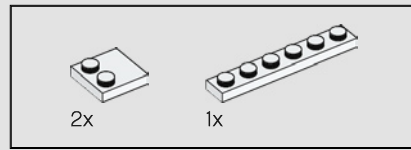
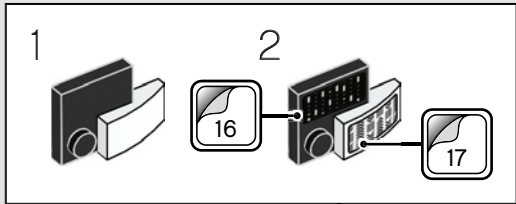
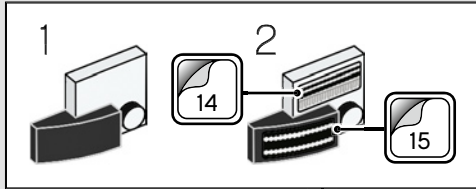

16

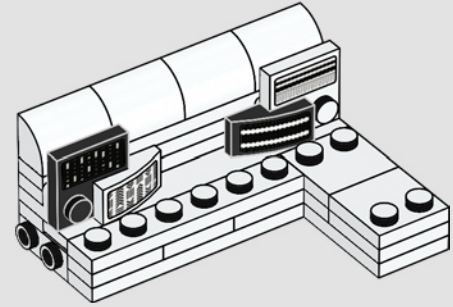

17

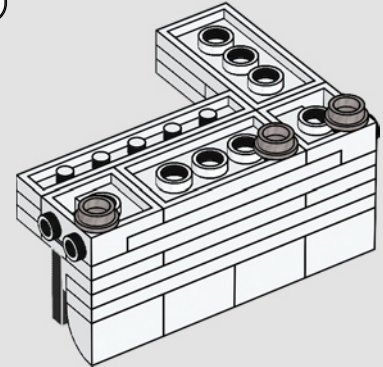
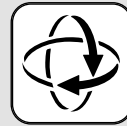

18

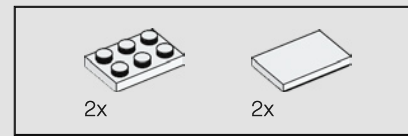
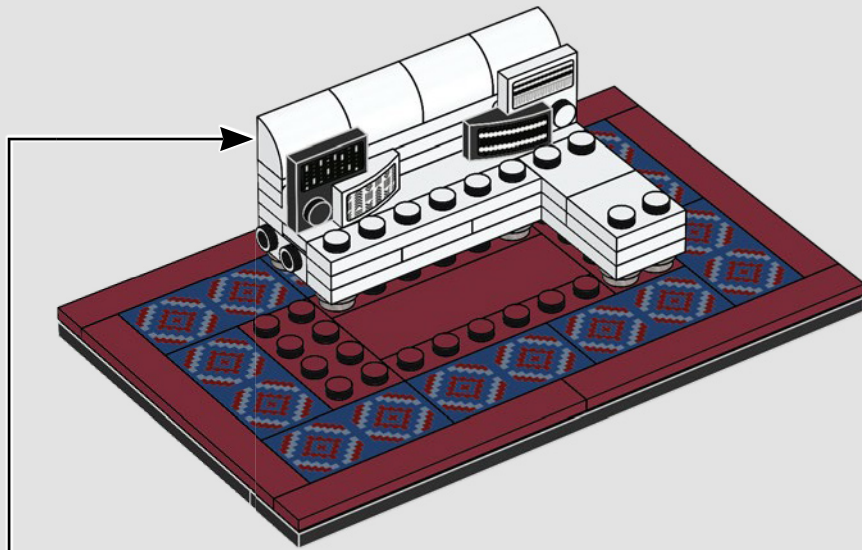

19

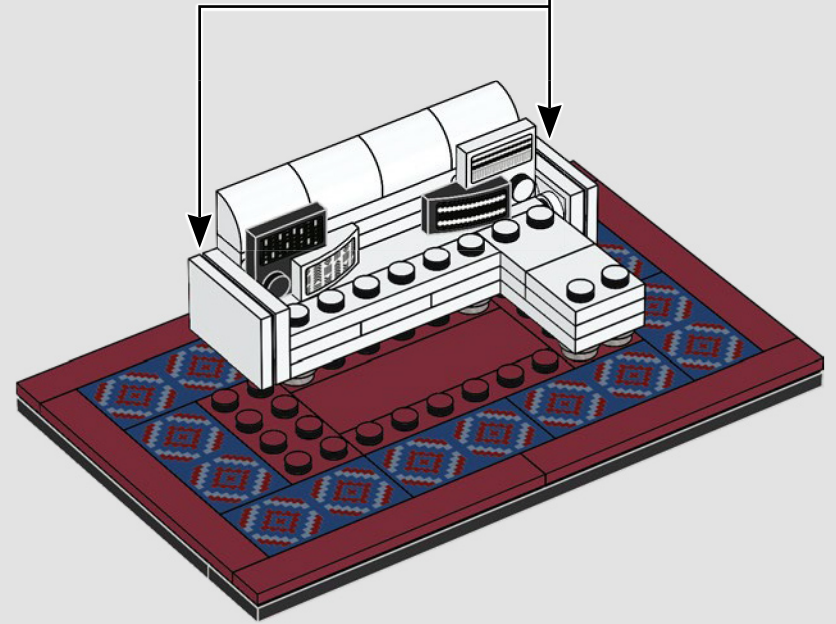
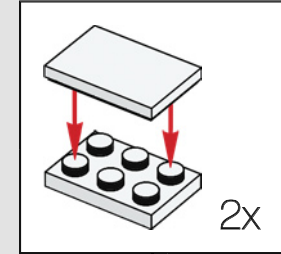

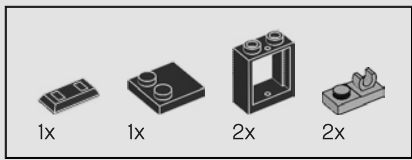

20

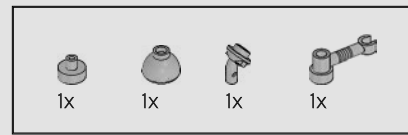
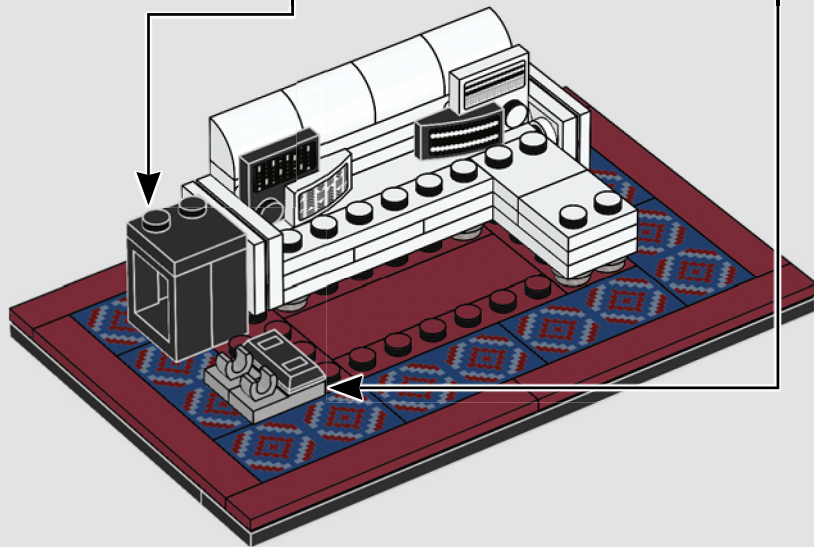
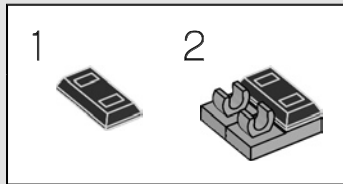
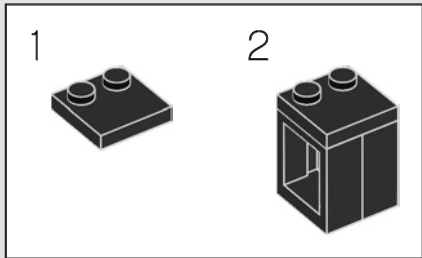

21

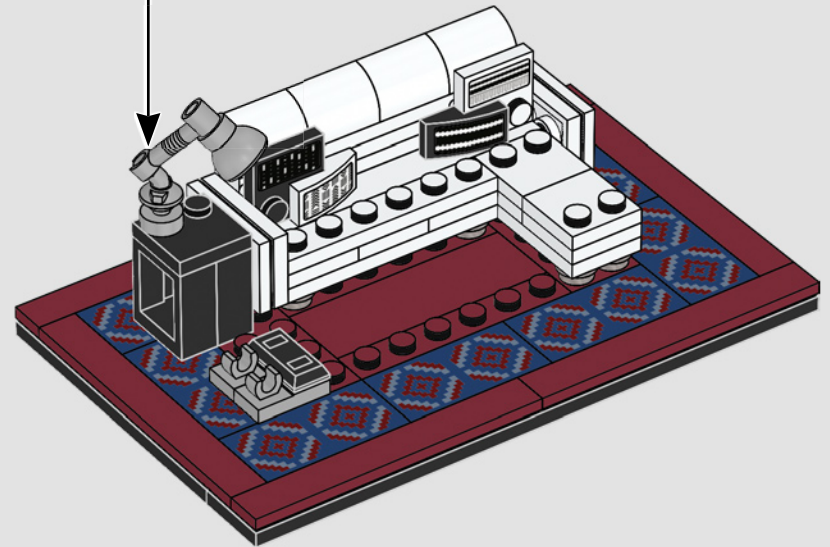
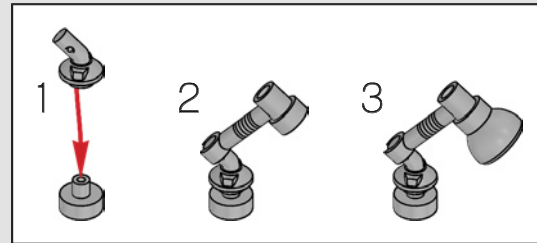

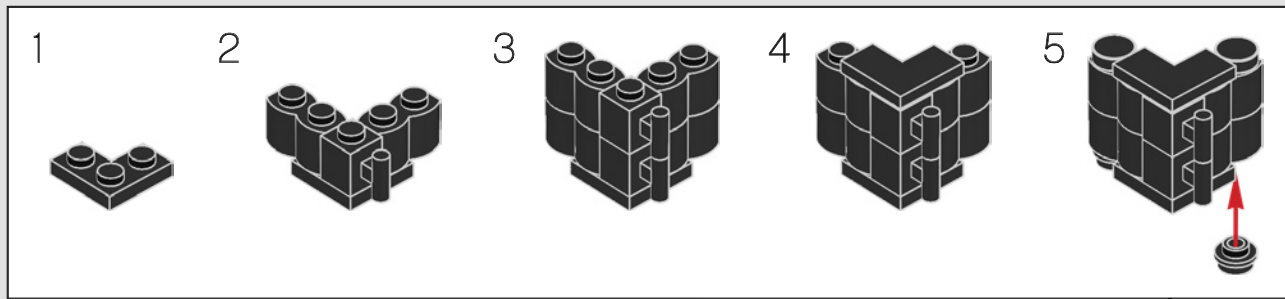
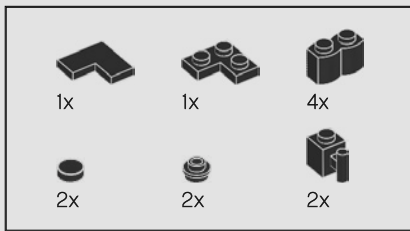

22

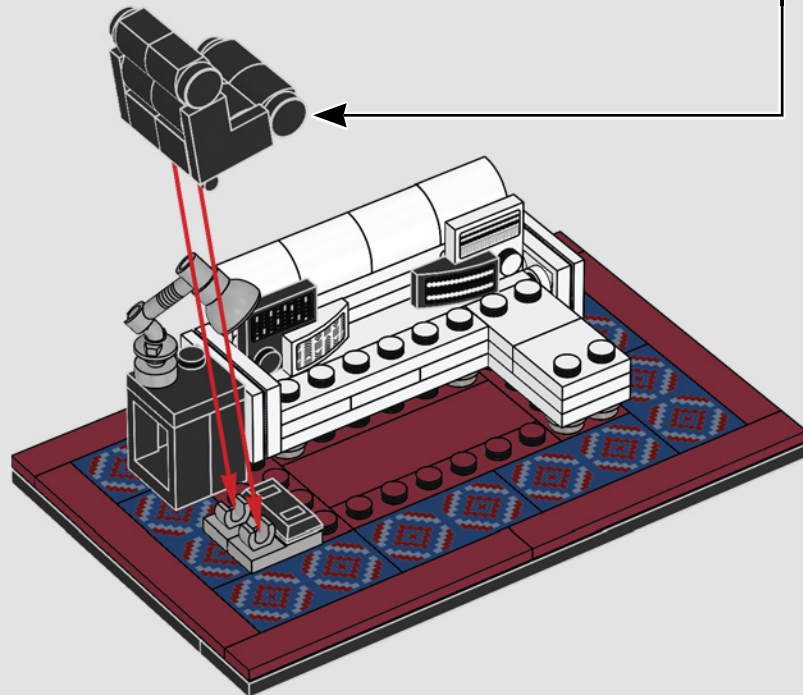

Tan France

"I love a creative process, and LEGO® is perfect for unleashing that creativity, you can build whatever you want in your own unique style."

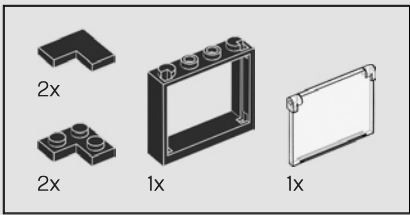

23

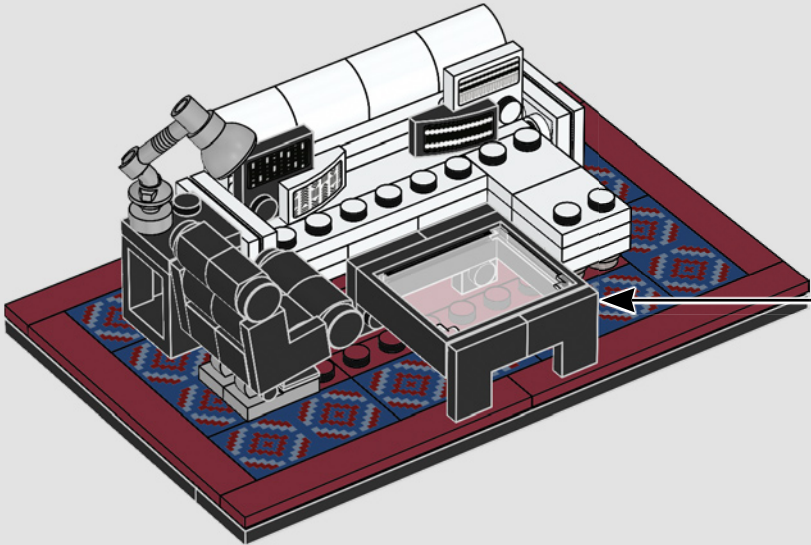
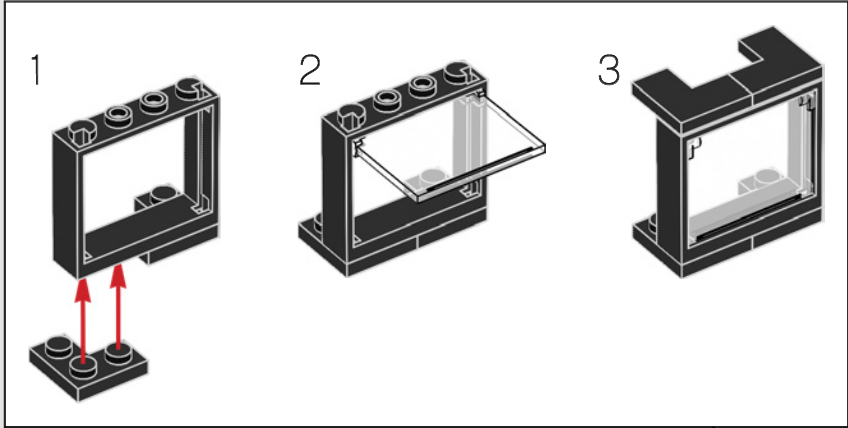

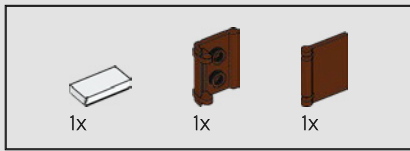

24



Karamo Brown

"Seeing this set is bringing back so many happy memories. It's like I have been shrunk down to a miniature scale and I can relive the show all over again!"

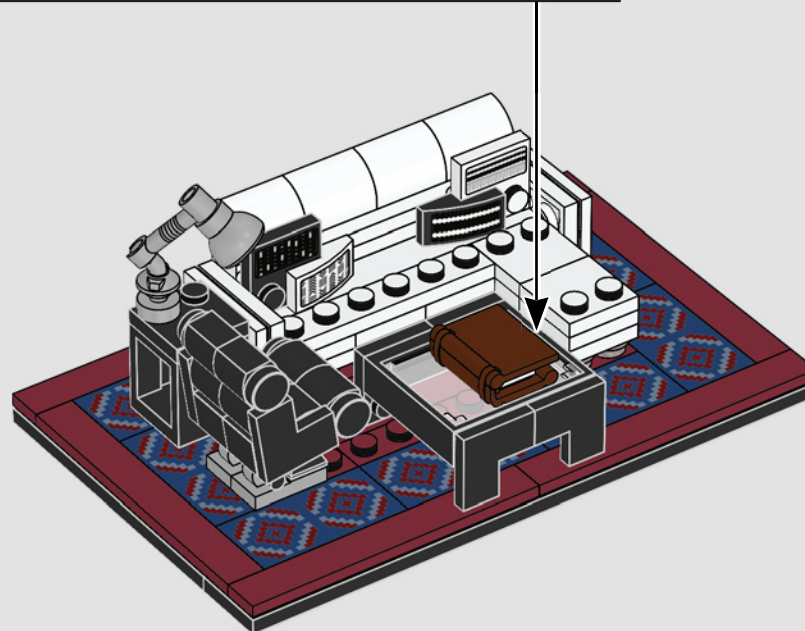
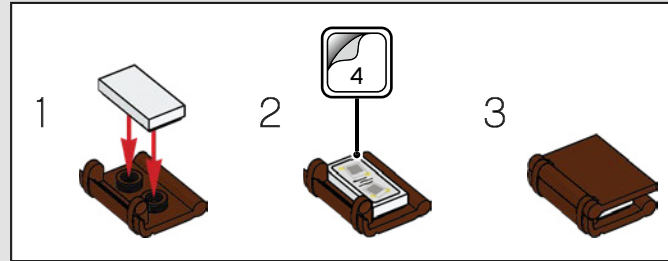

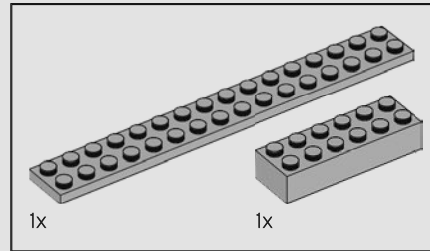
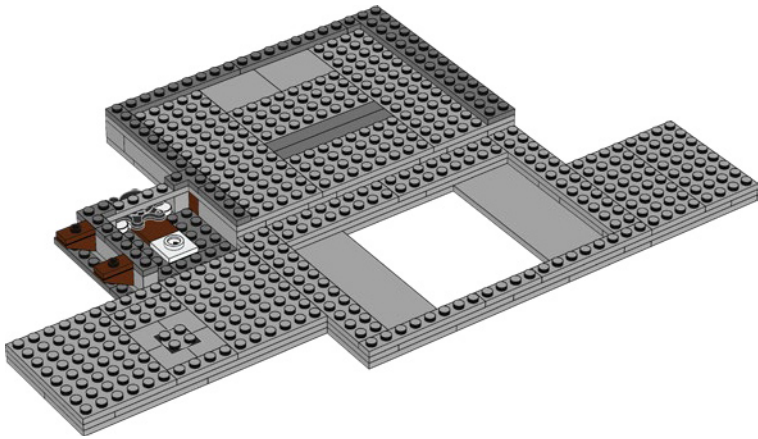
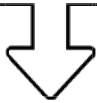

1

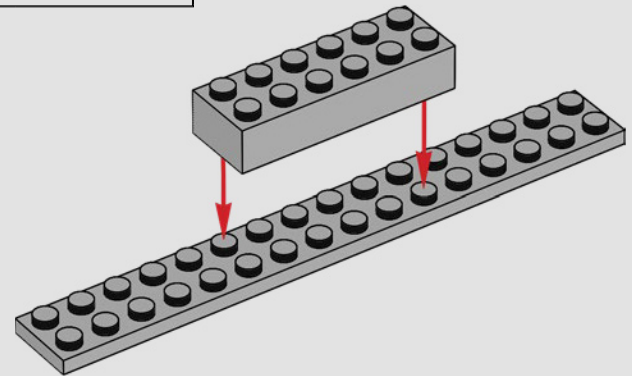

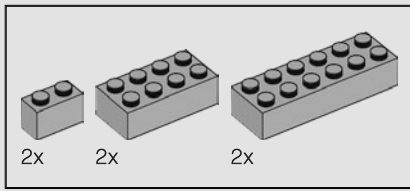

2

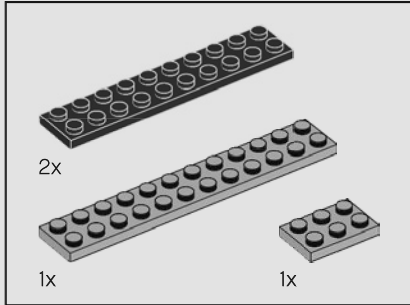
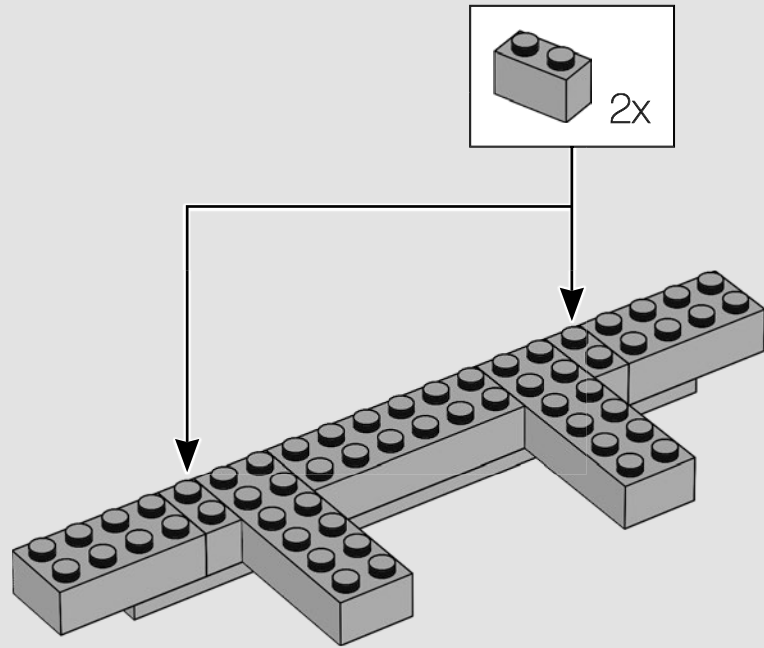

3

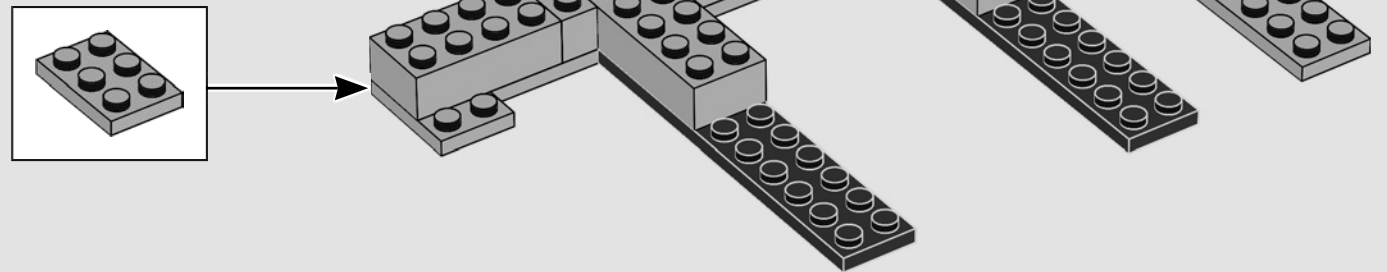

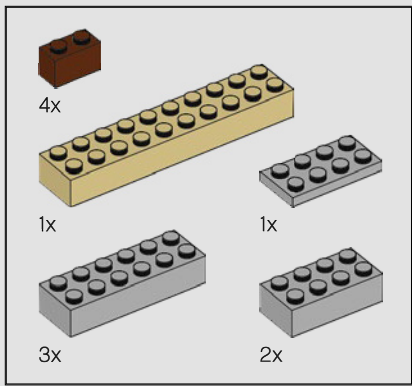

Karamo Brown

"Queer Eye is special because of the people; the amazing cast I work with every day and the beautiful lives I get to touch and interact with on the show and share with the world."

4

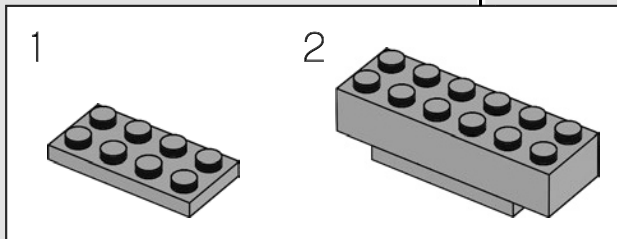
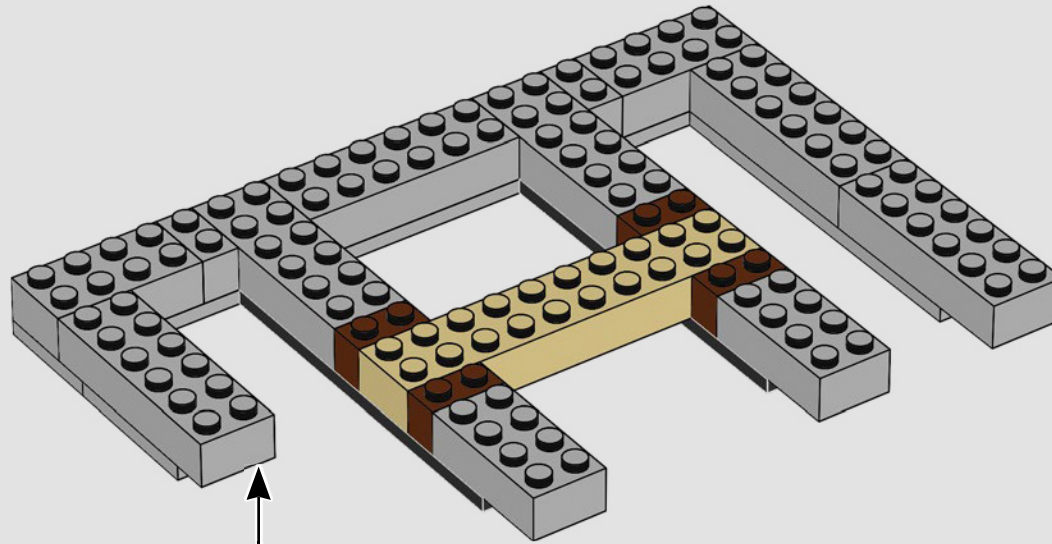

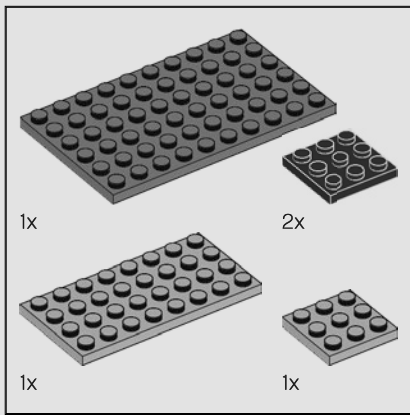

5

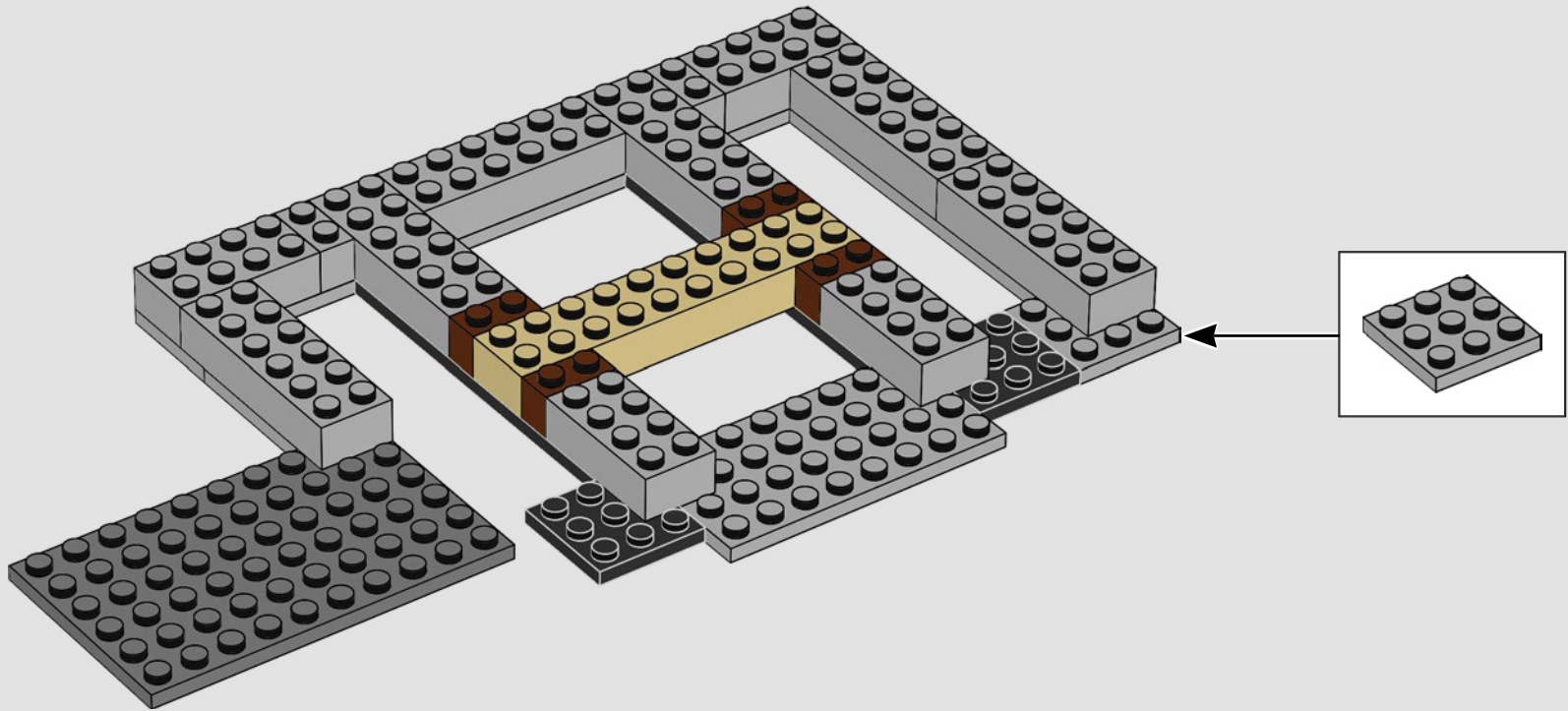

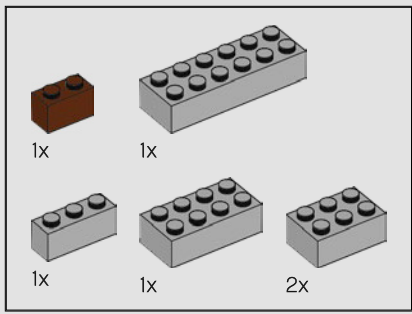

6

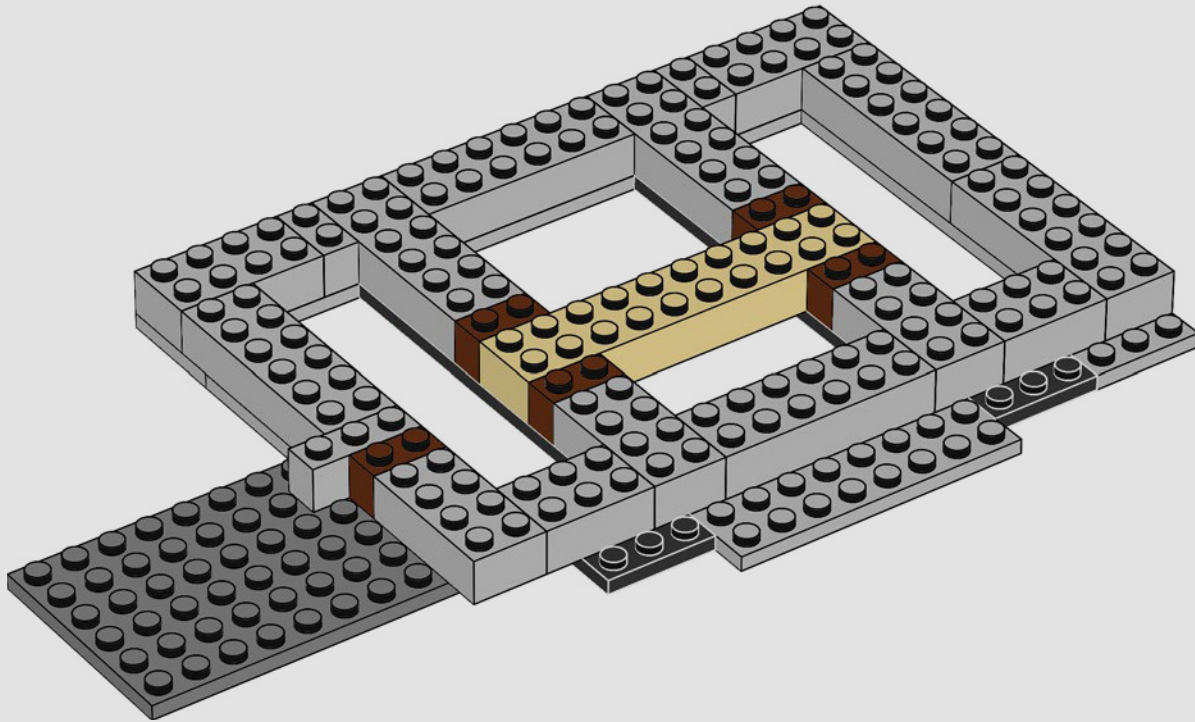

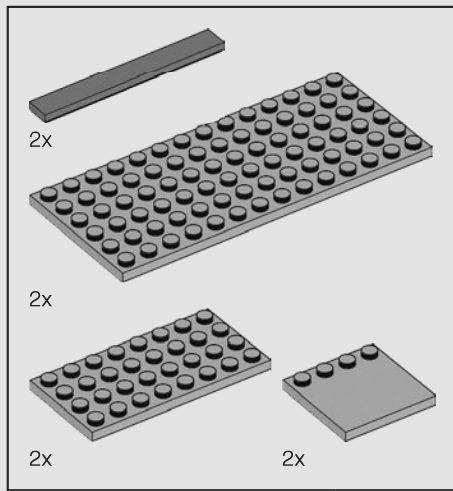

7

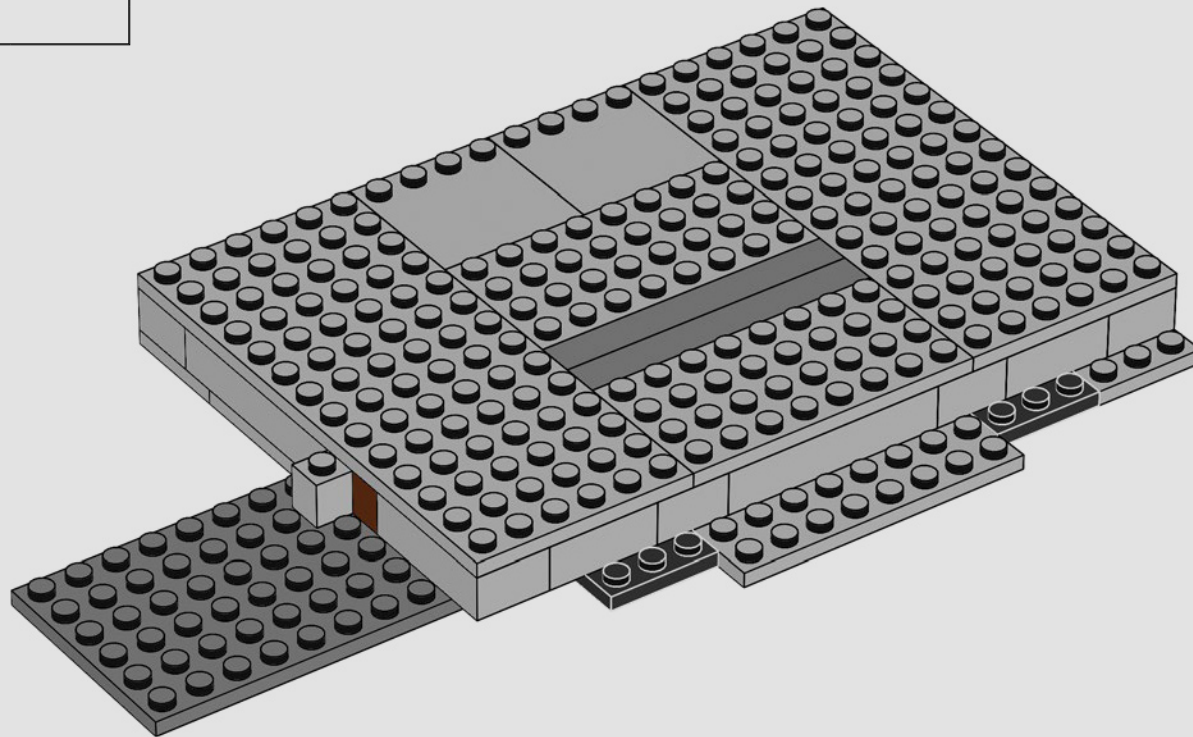

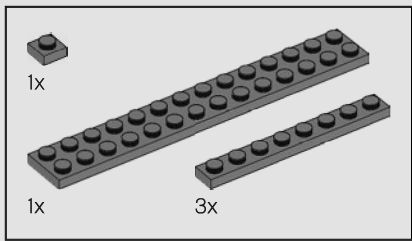

8

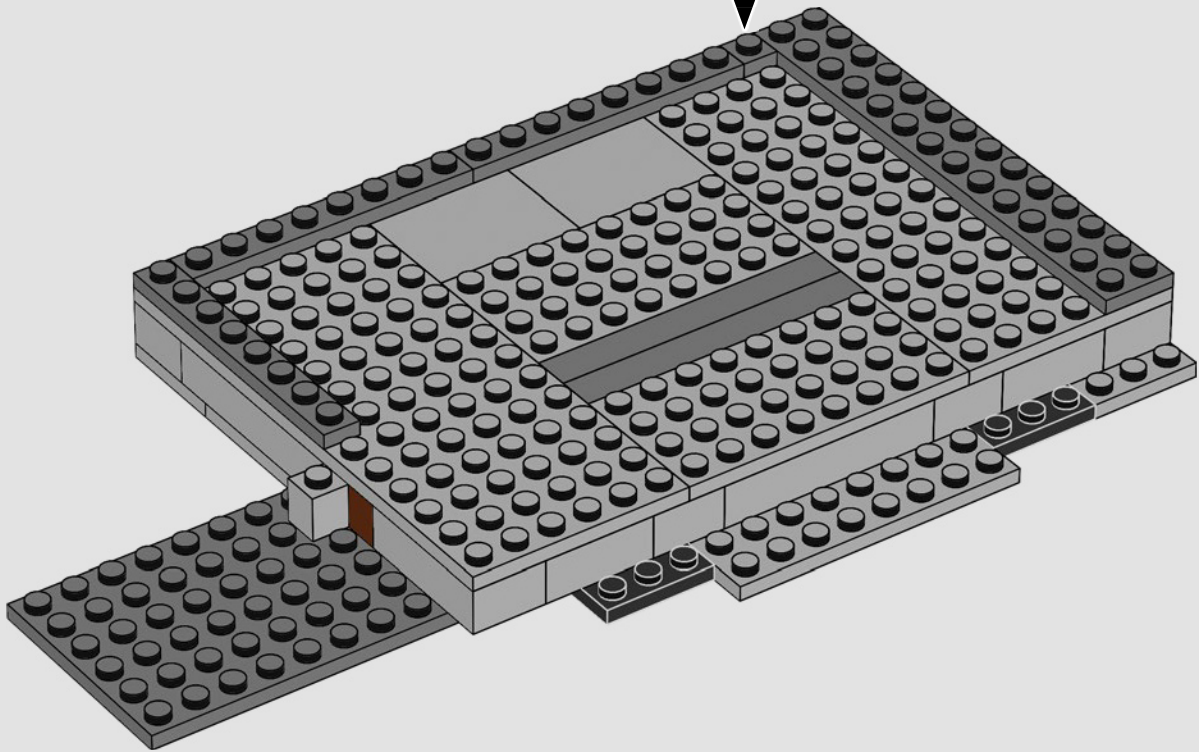
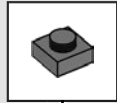

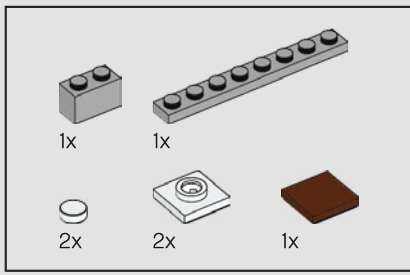

9

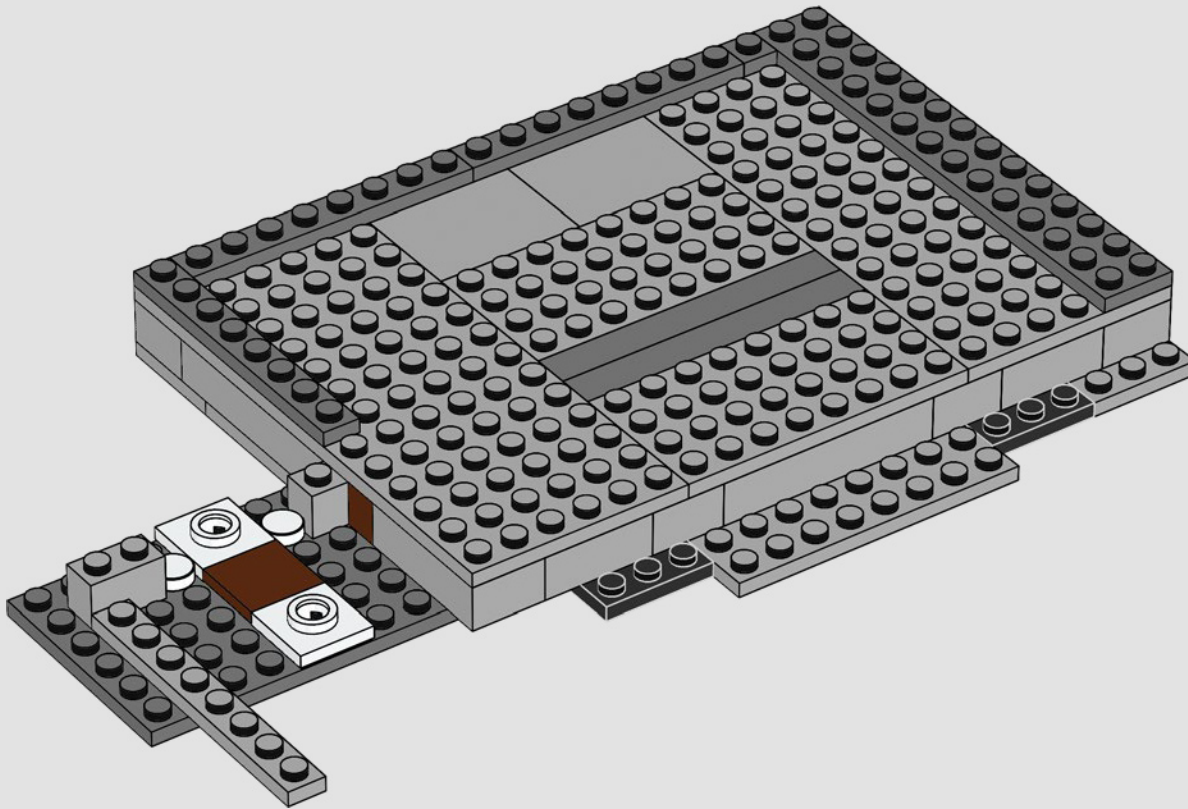

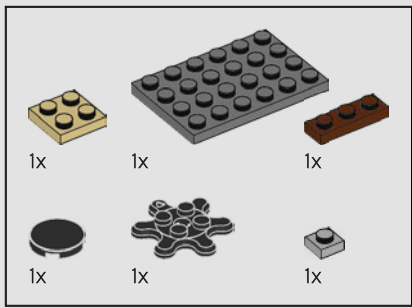

10

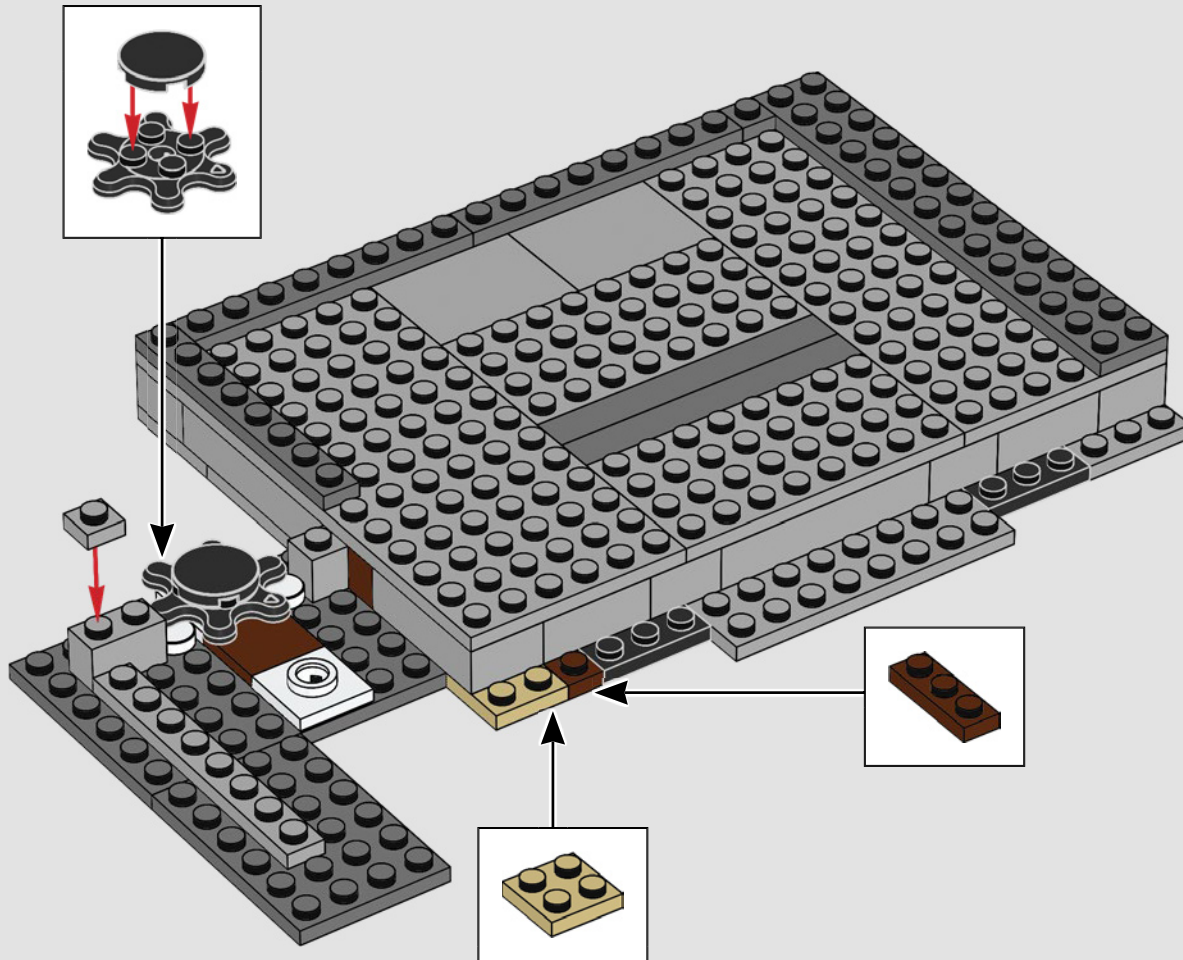

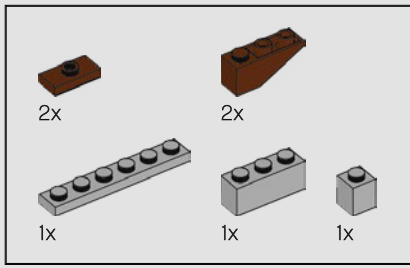

11

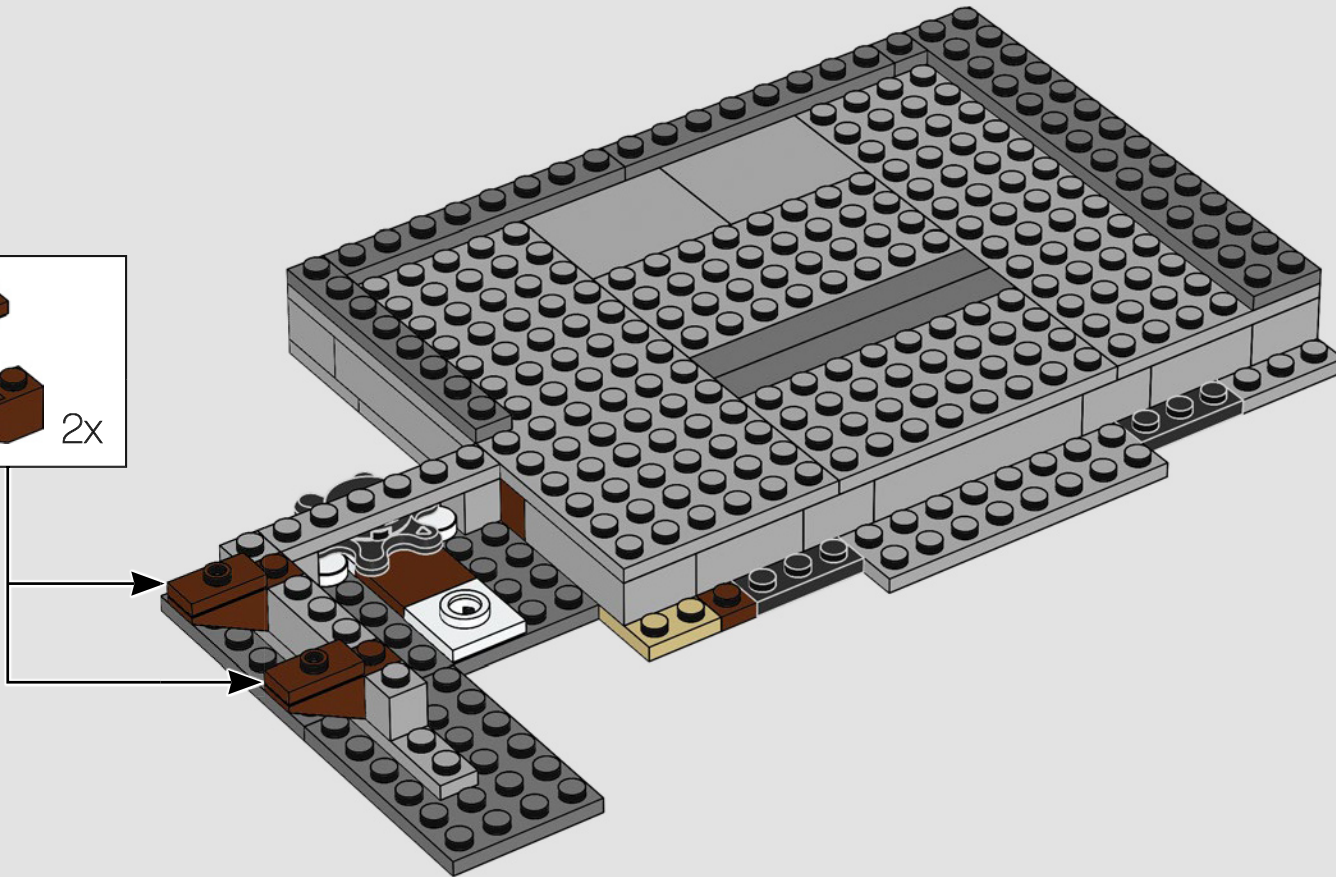
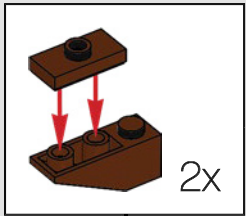

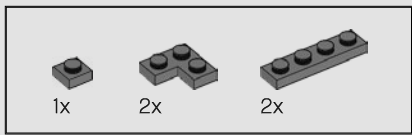

12

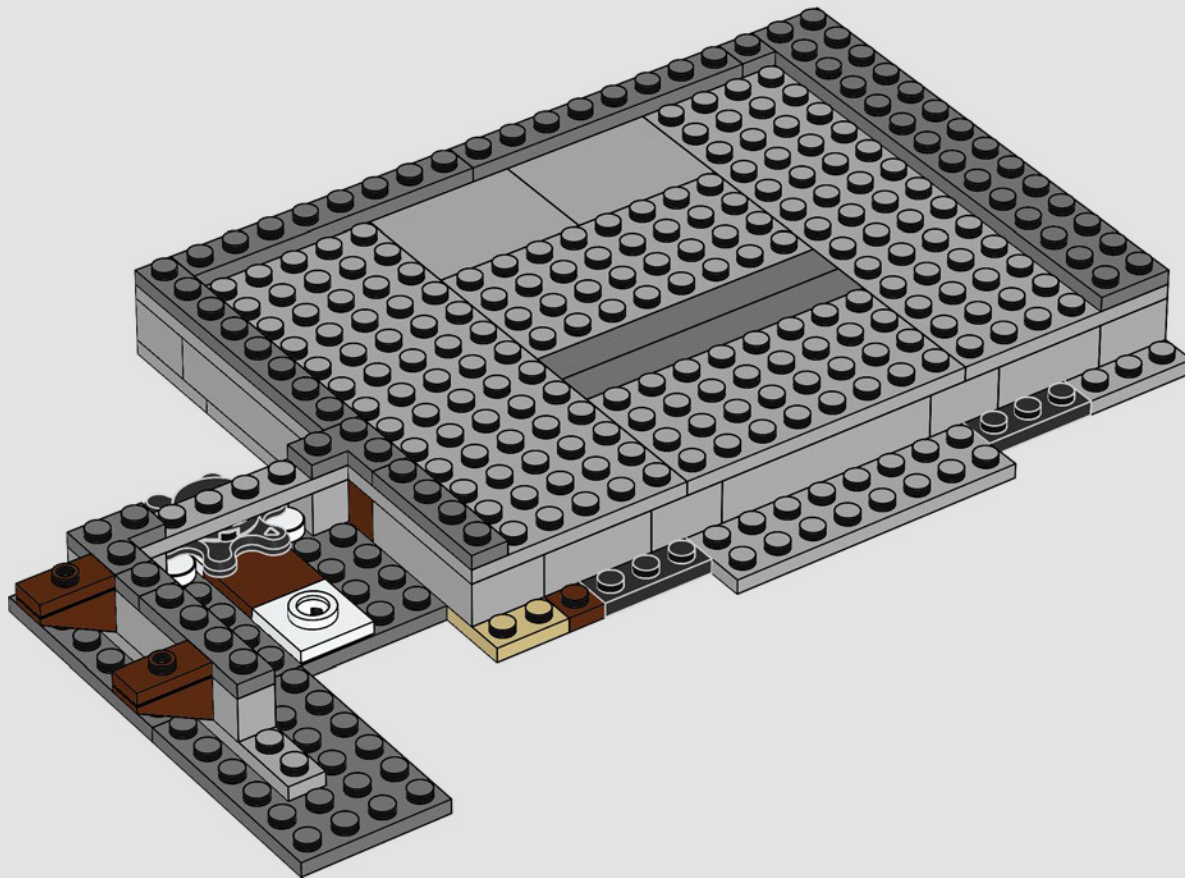

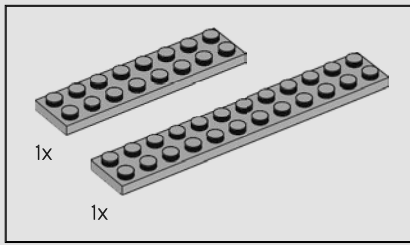

13

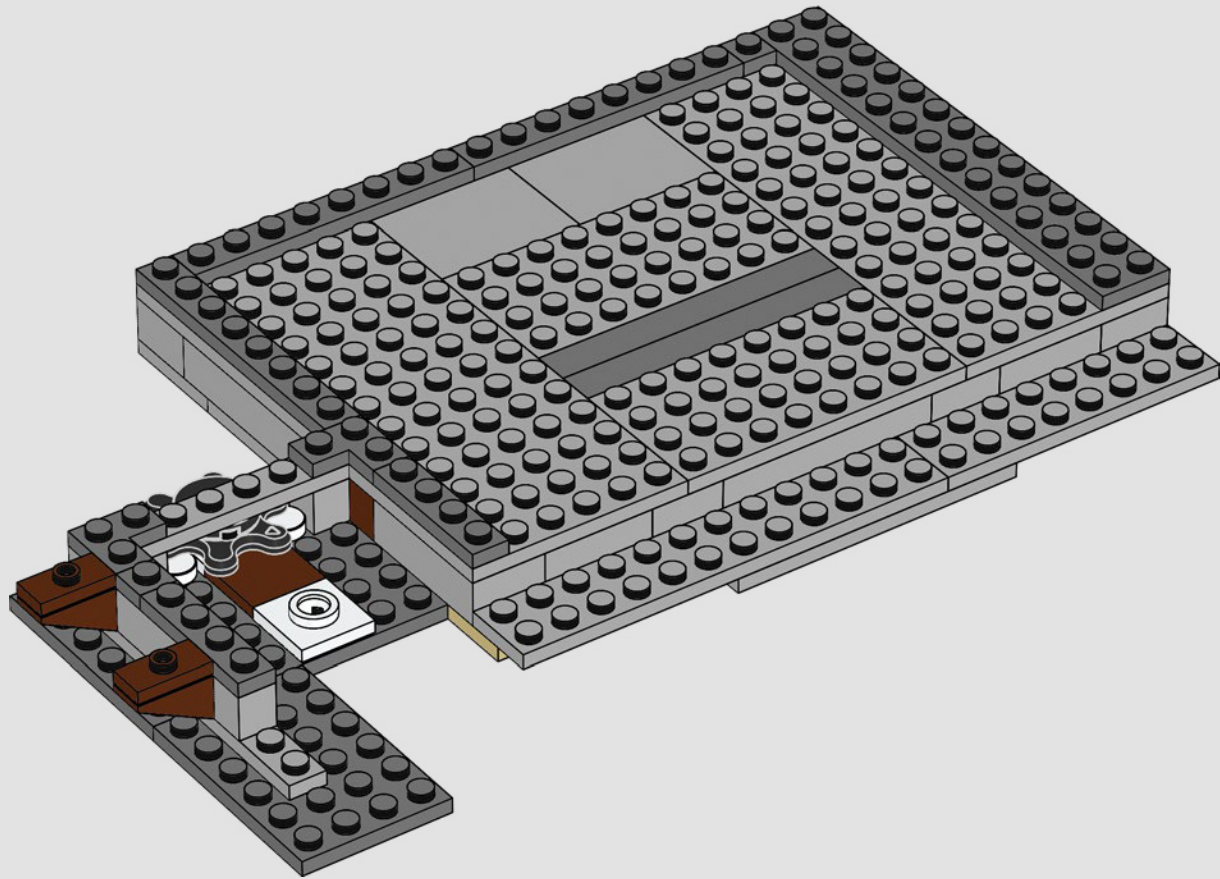

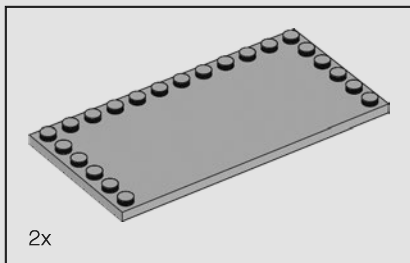

2x

14

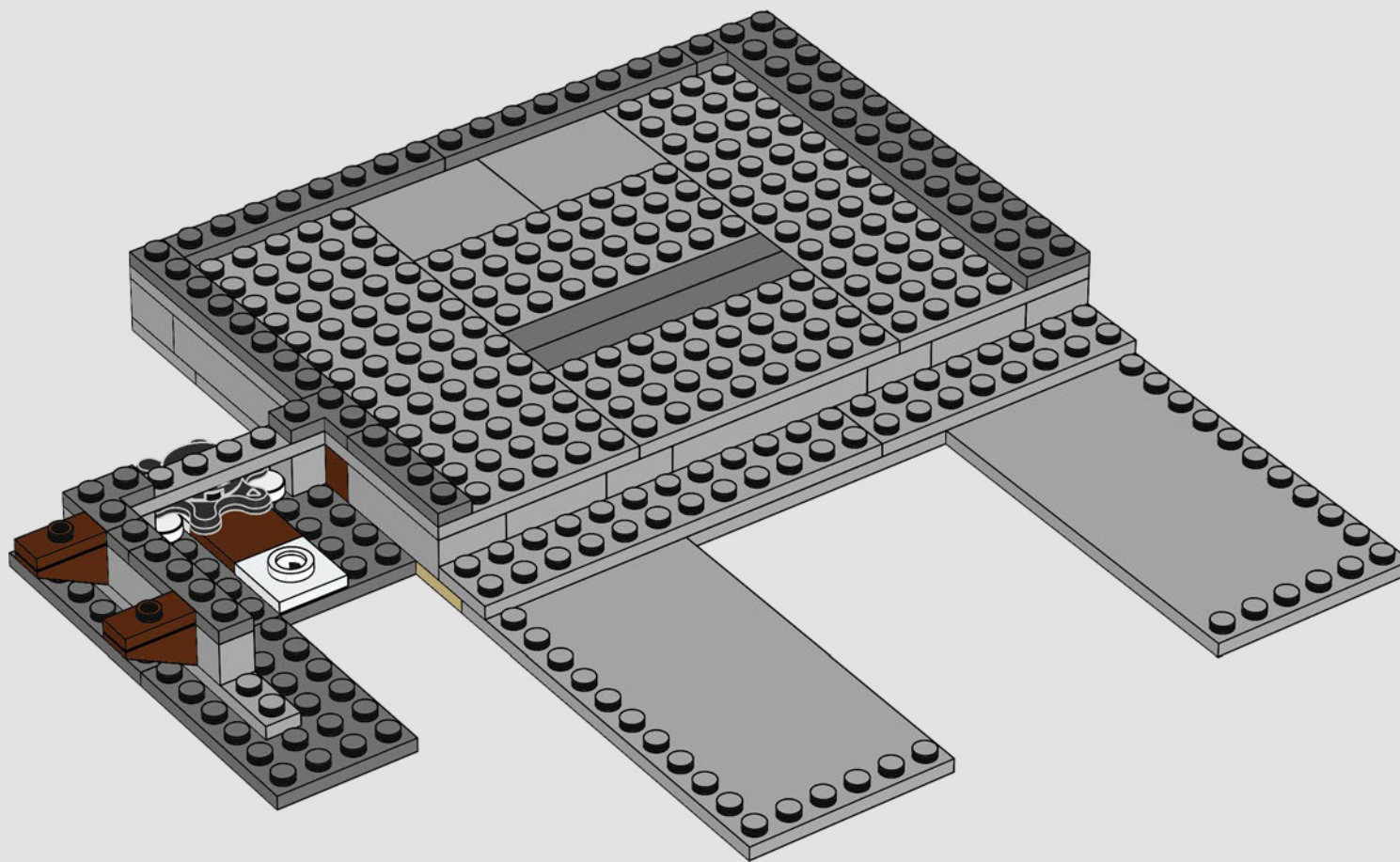

Jonathan Van Ness

"My goal on Queer Eye is creating a legacy of connection and understanding, not only with those around us but also understanding and accepting ourselves, too."

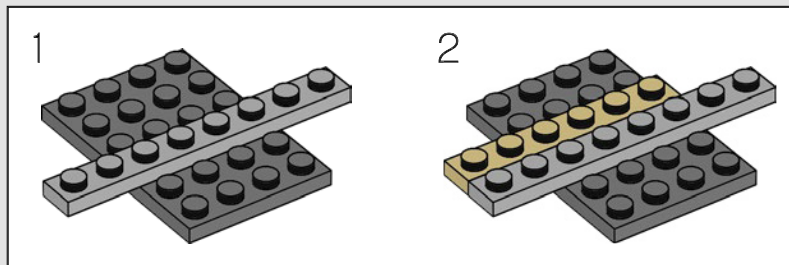
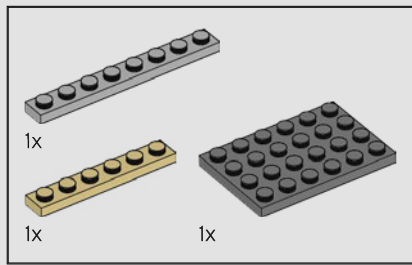

15

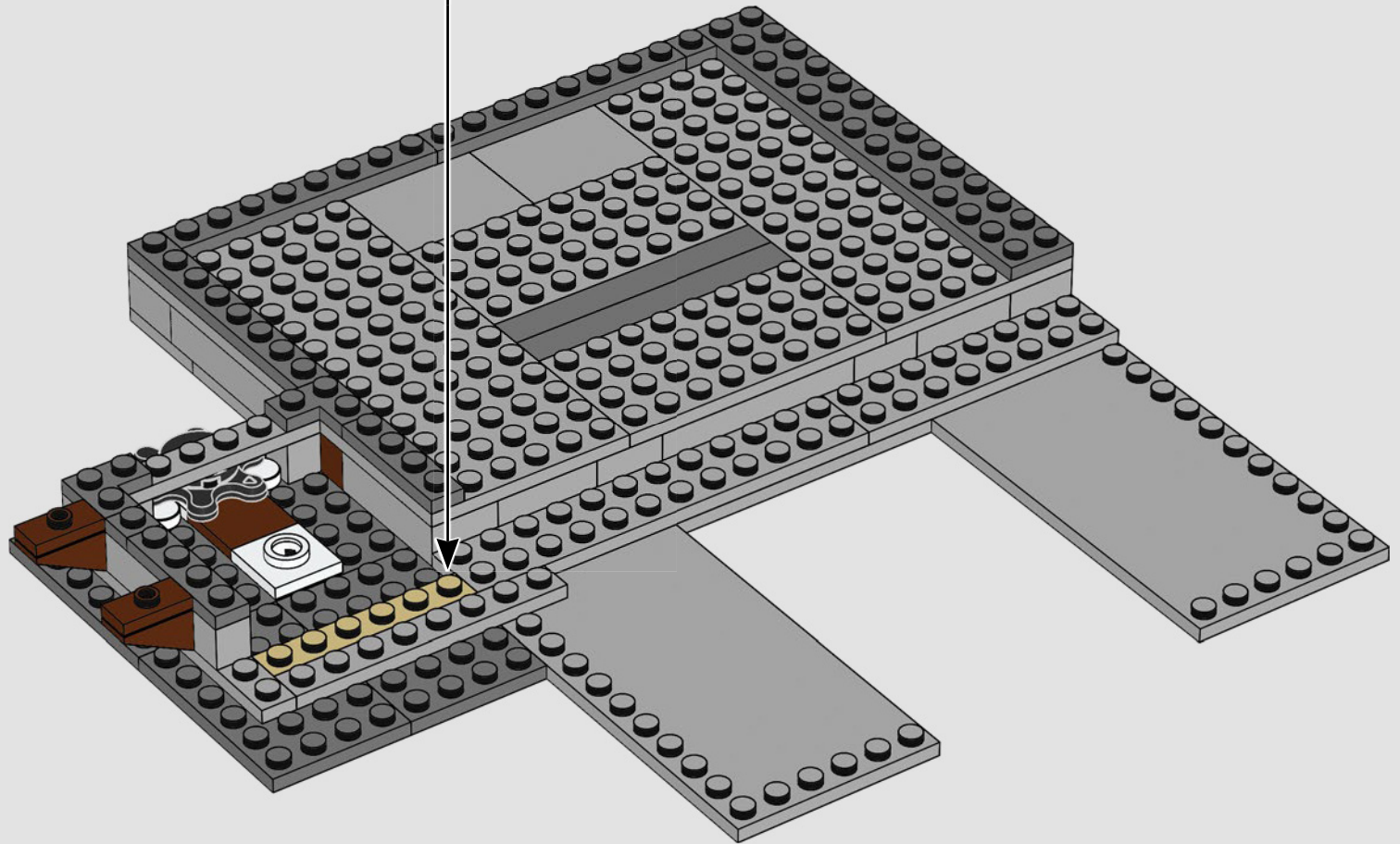

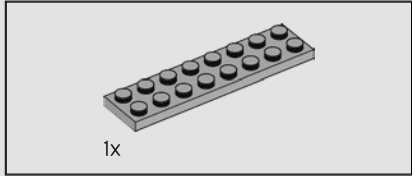
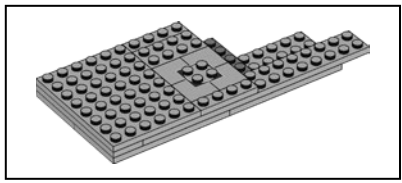

16

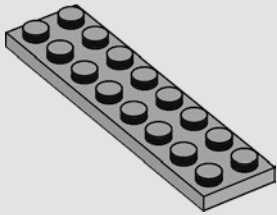

17

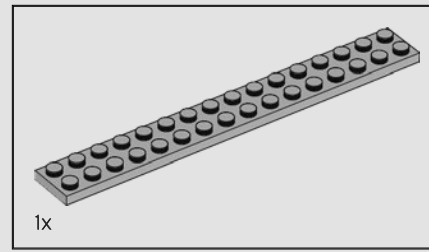
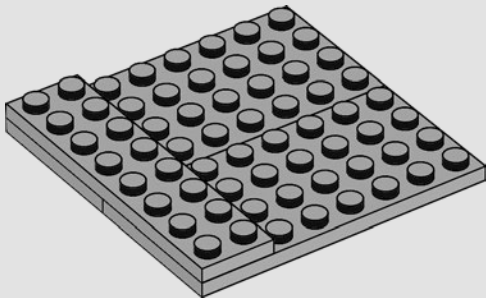

18

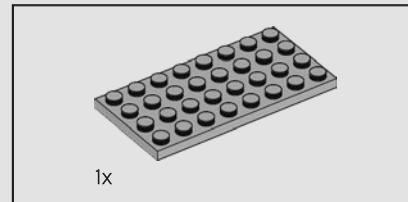
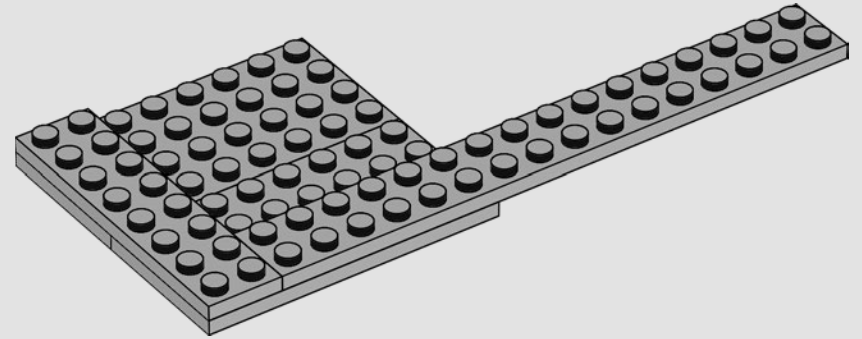

19

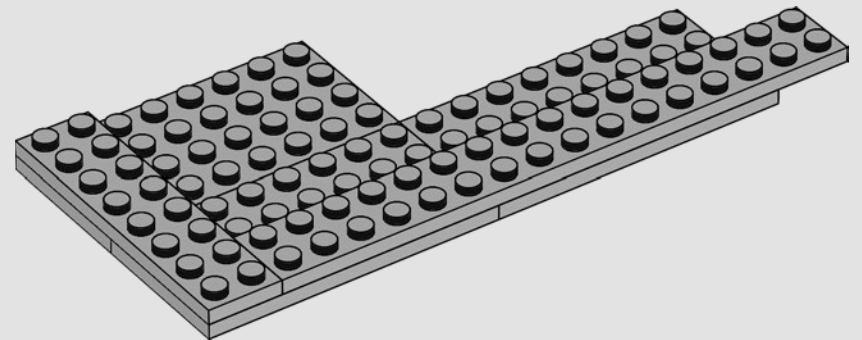

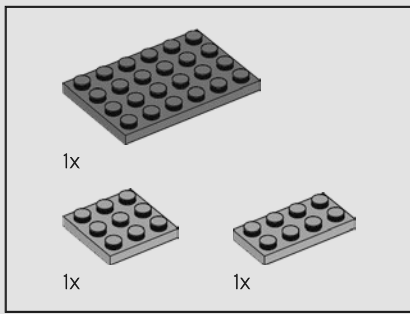

20

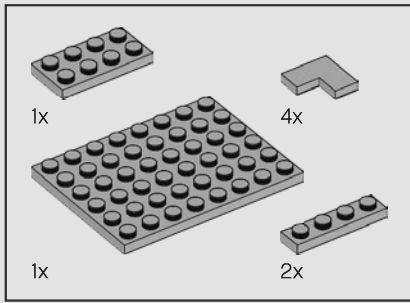
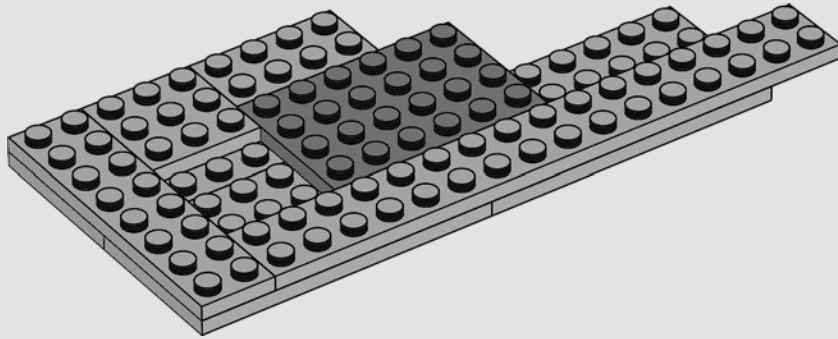

21

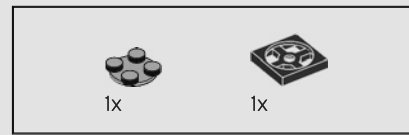
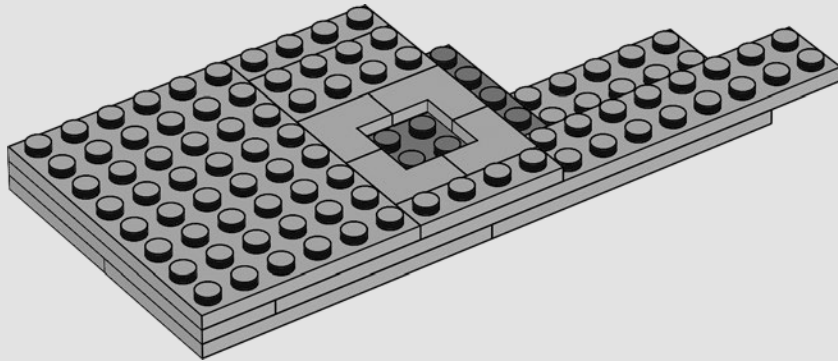

22

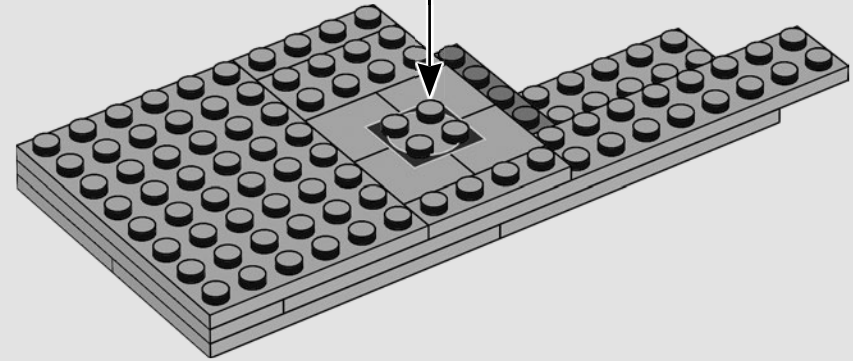
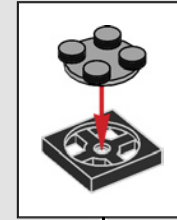



Karamo Brown

"LEGO® has been really special to me and my family. Not only has LEGO kept my boys entertained for hours, it has also been a great activity for me to connect and bond with them over even more."

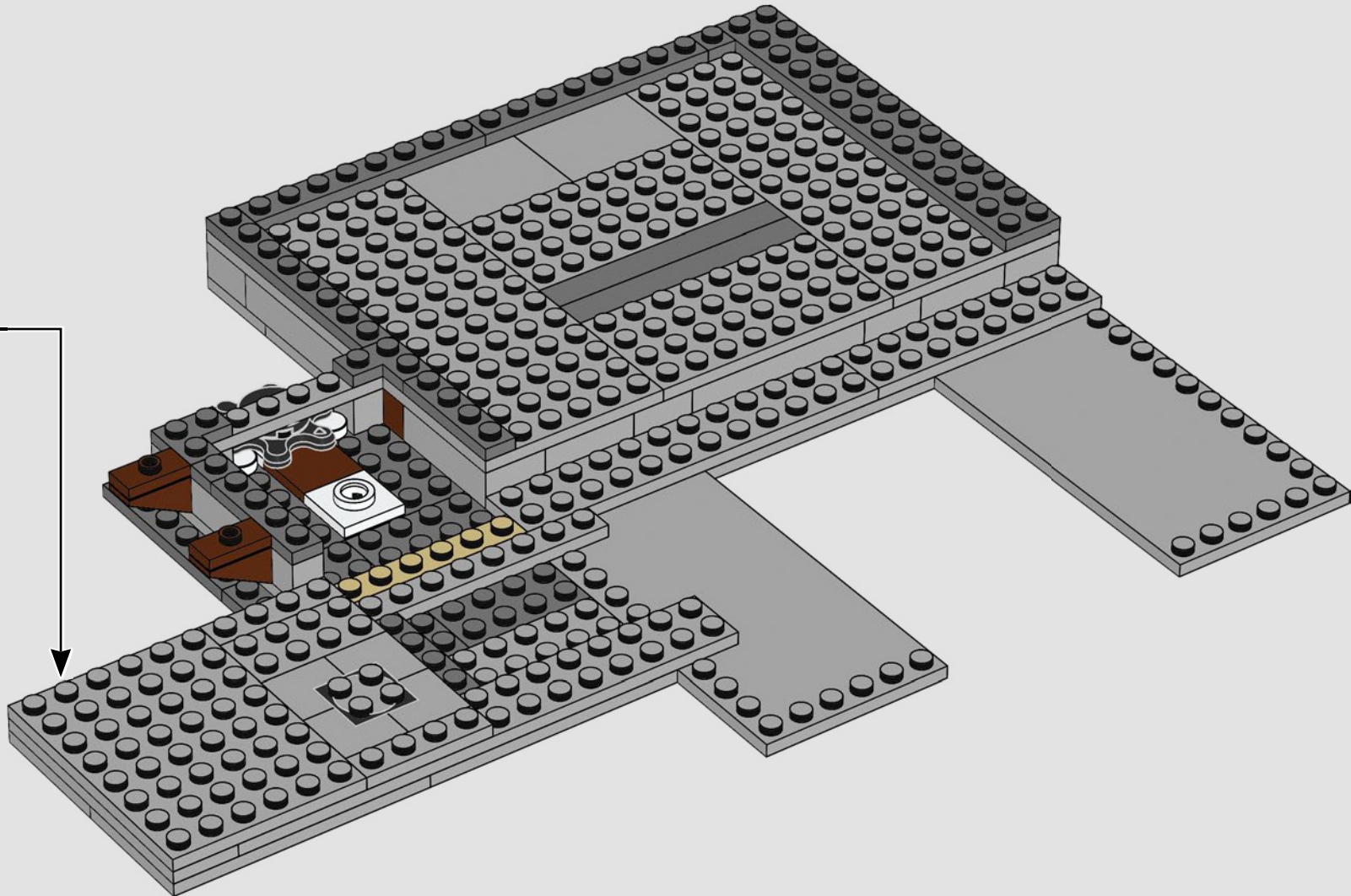

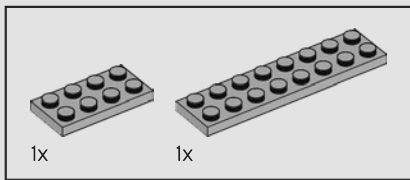

24

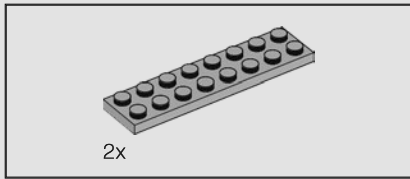
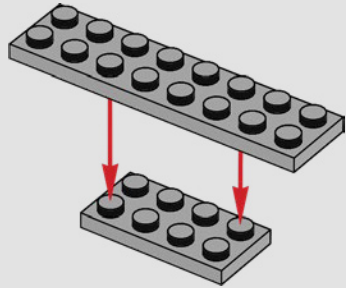

25

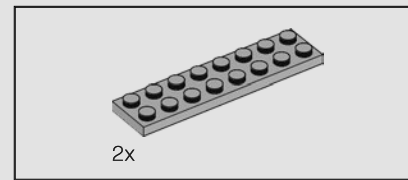
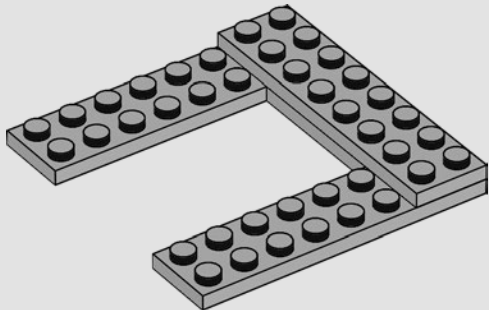

26

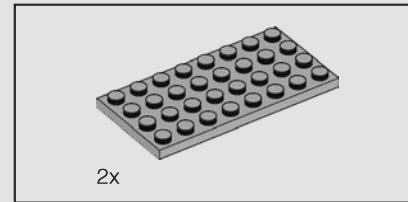
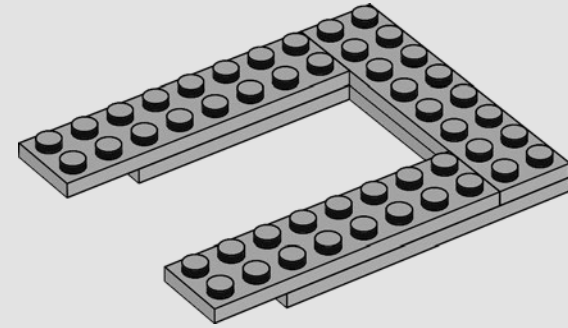

27

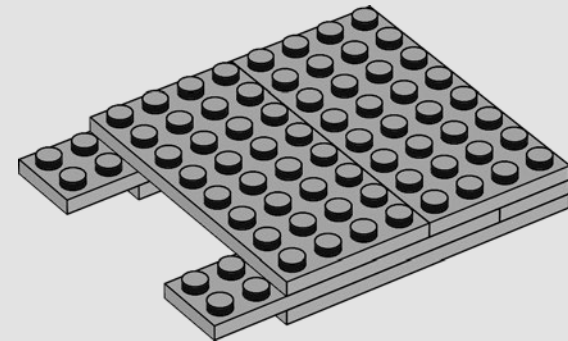

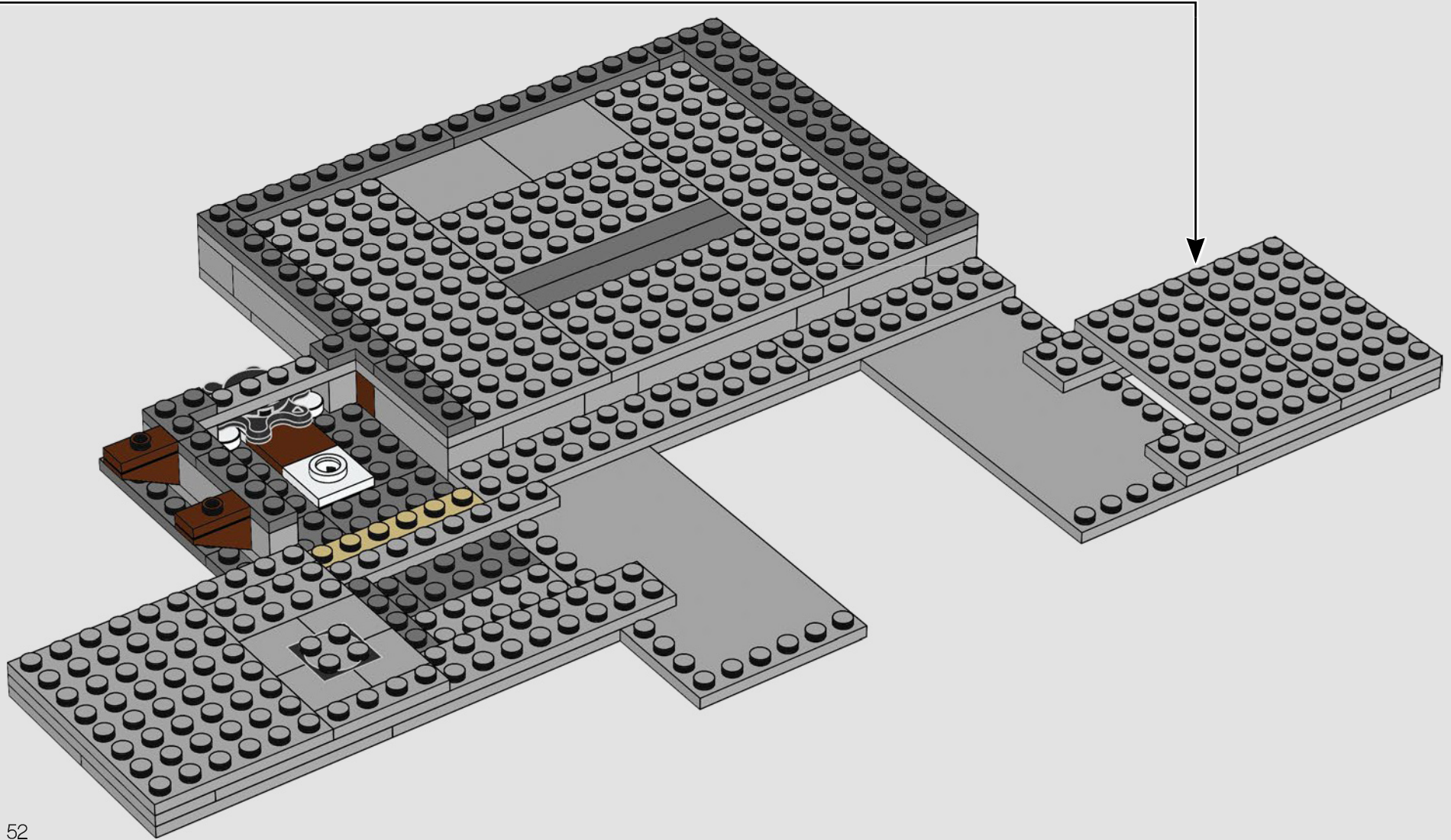

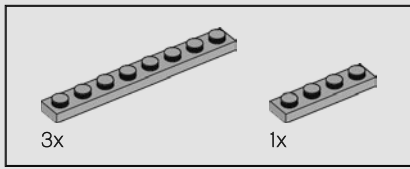

29

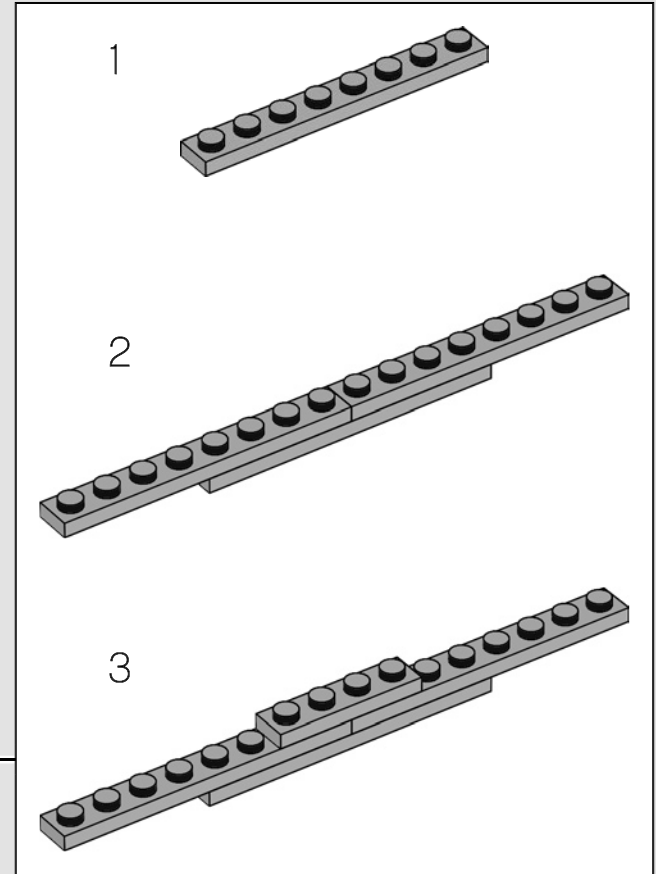
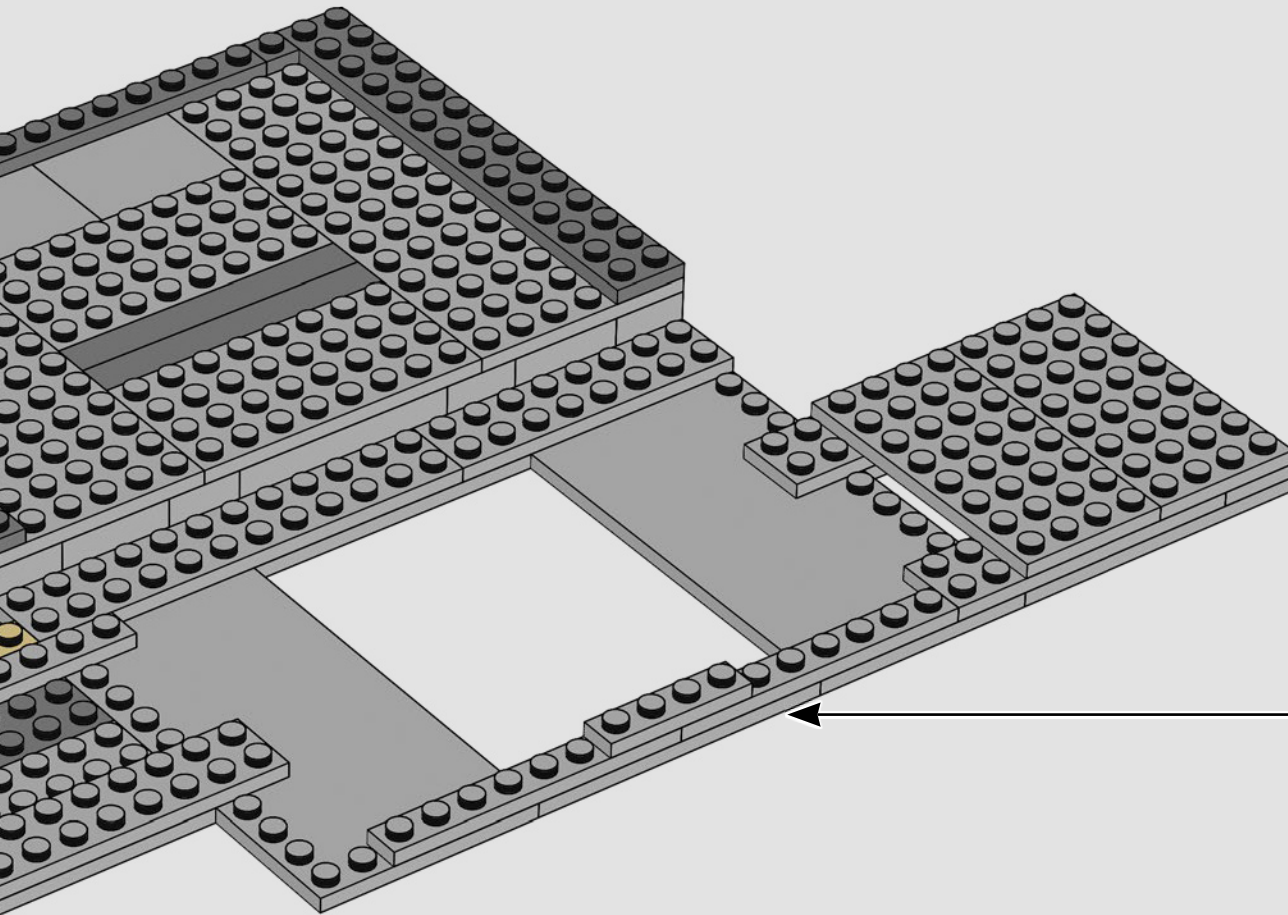

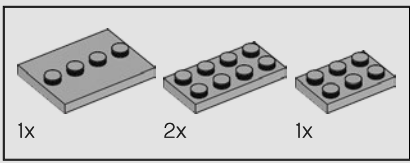

30

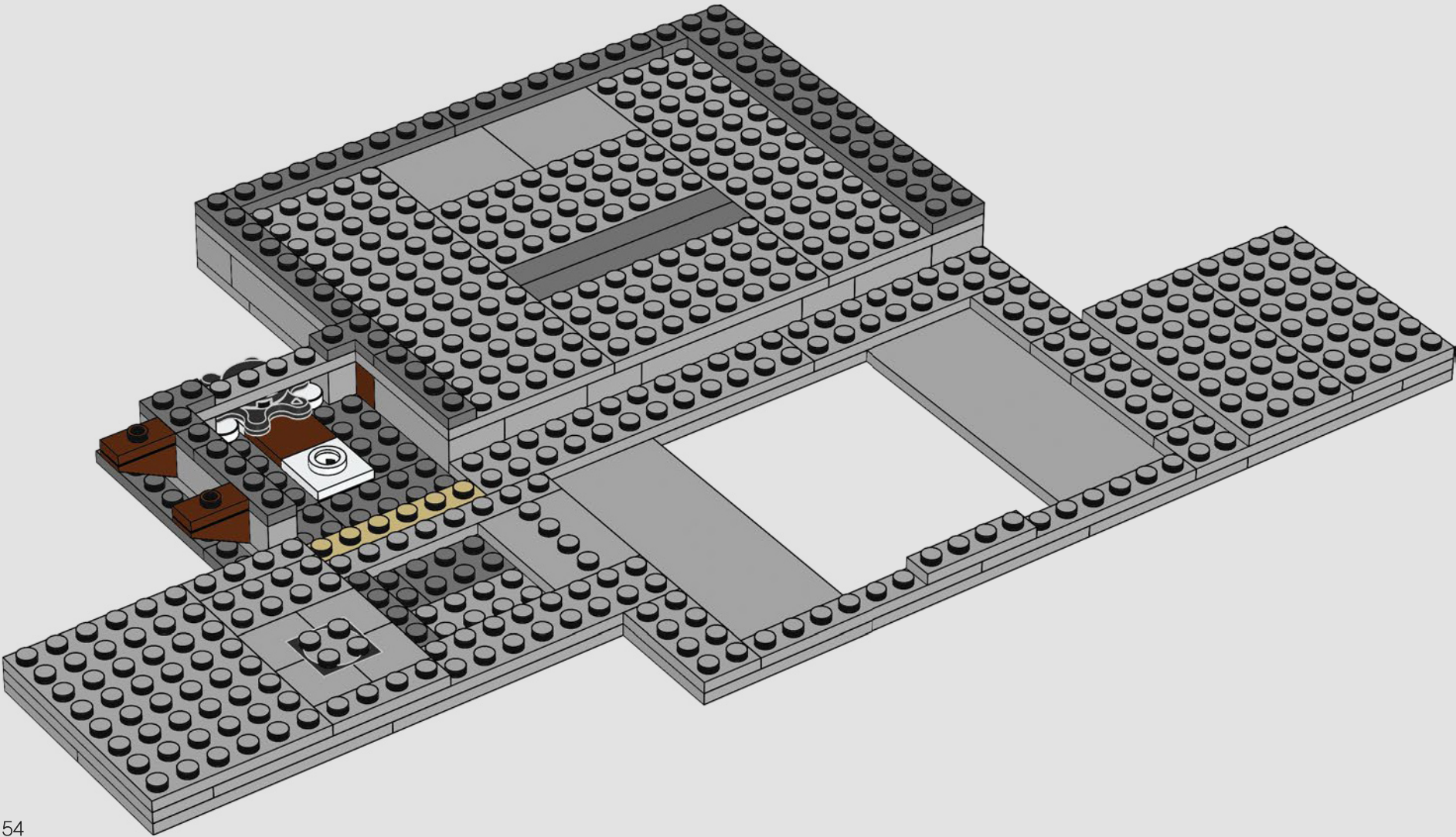

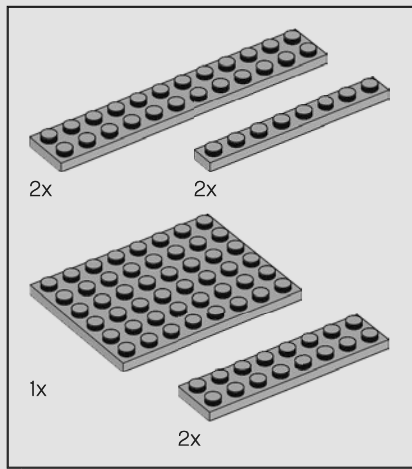

31

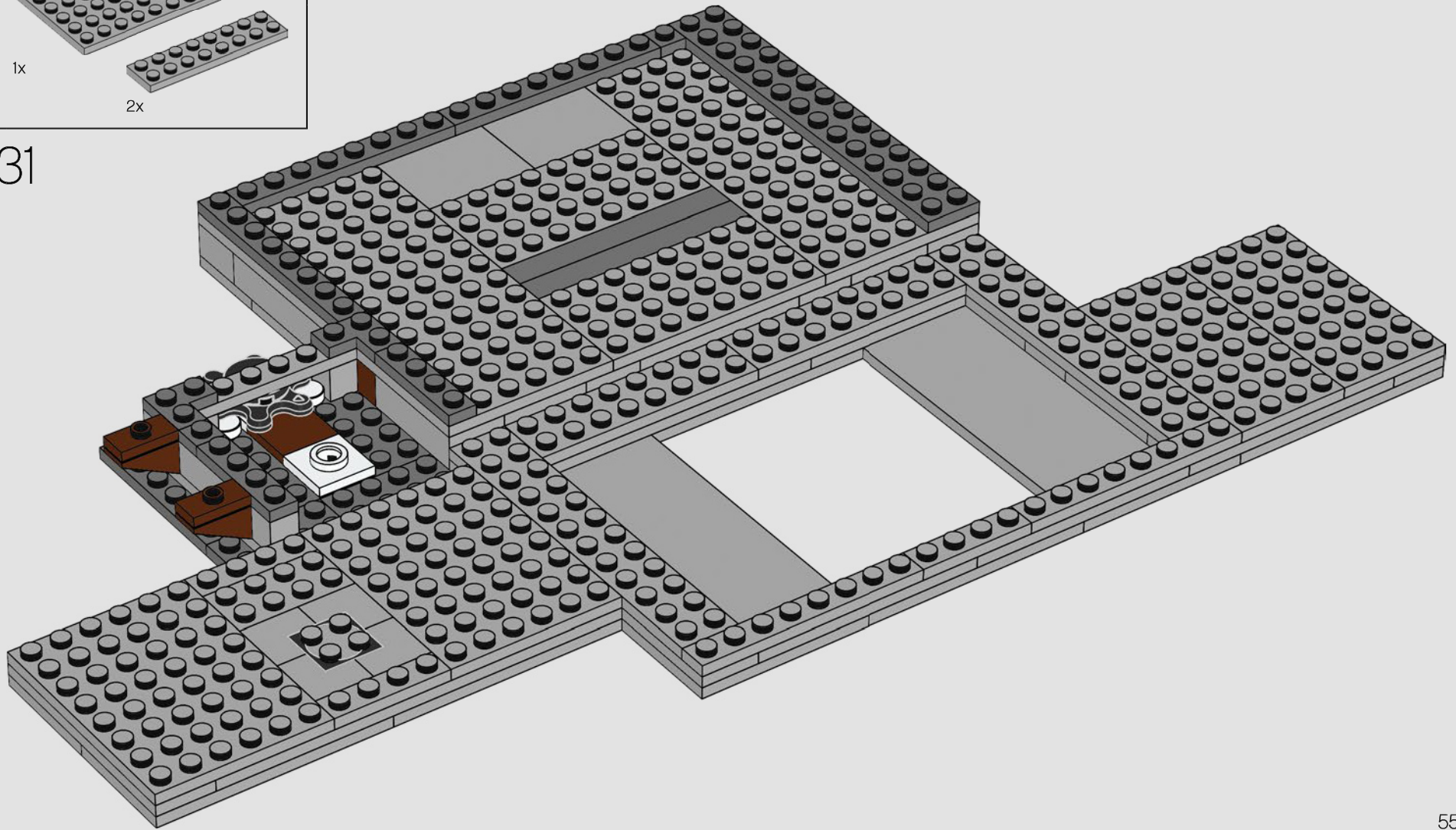

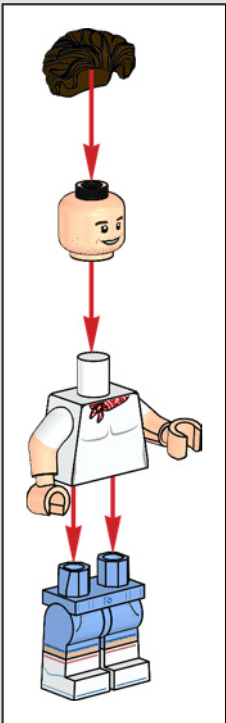
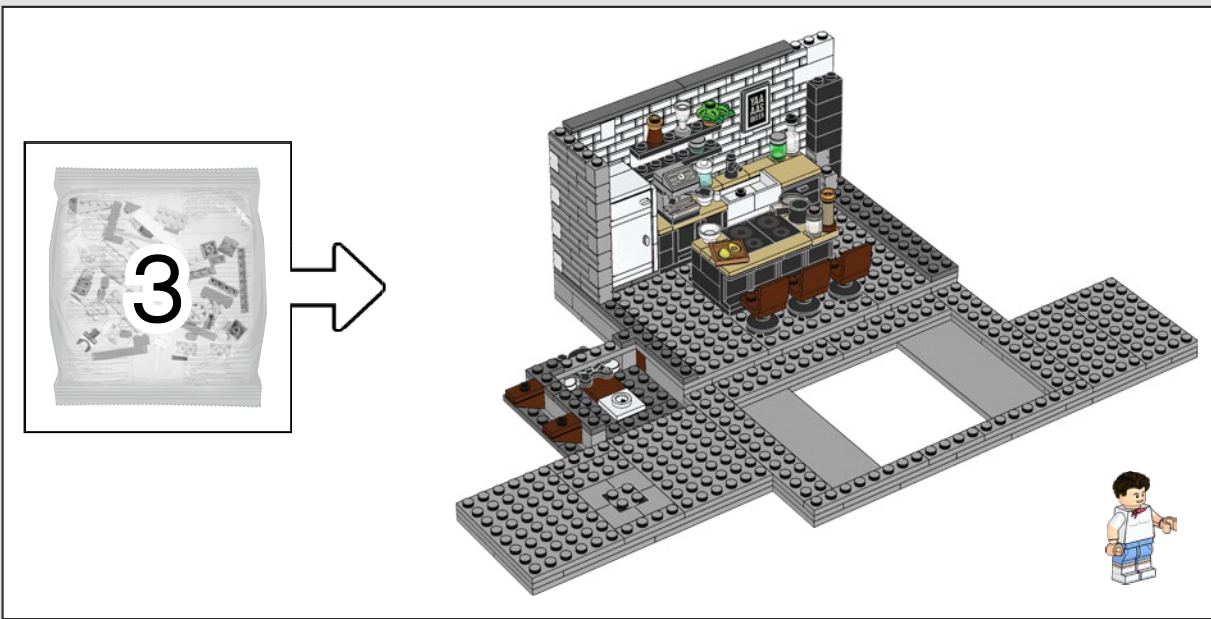

Antoni Porowski

"Loving that little neckerchief, and of course my LEGO® accessory had to be a tiny chopping board with avocados."

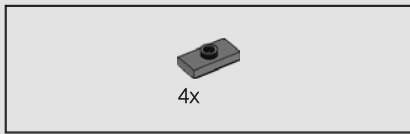

32

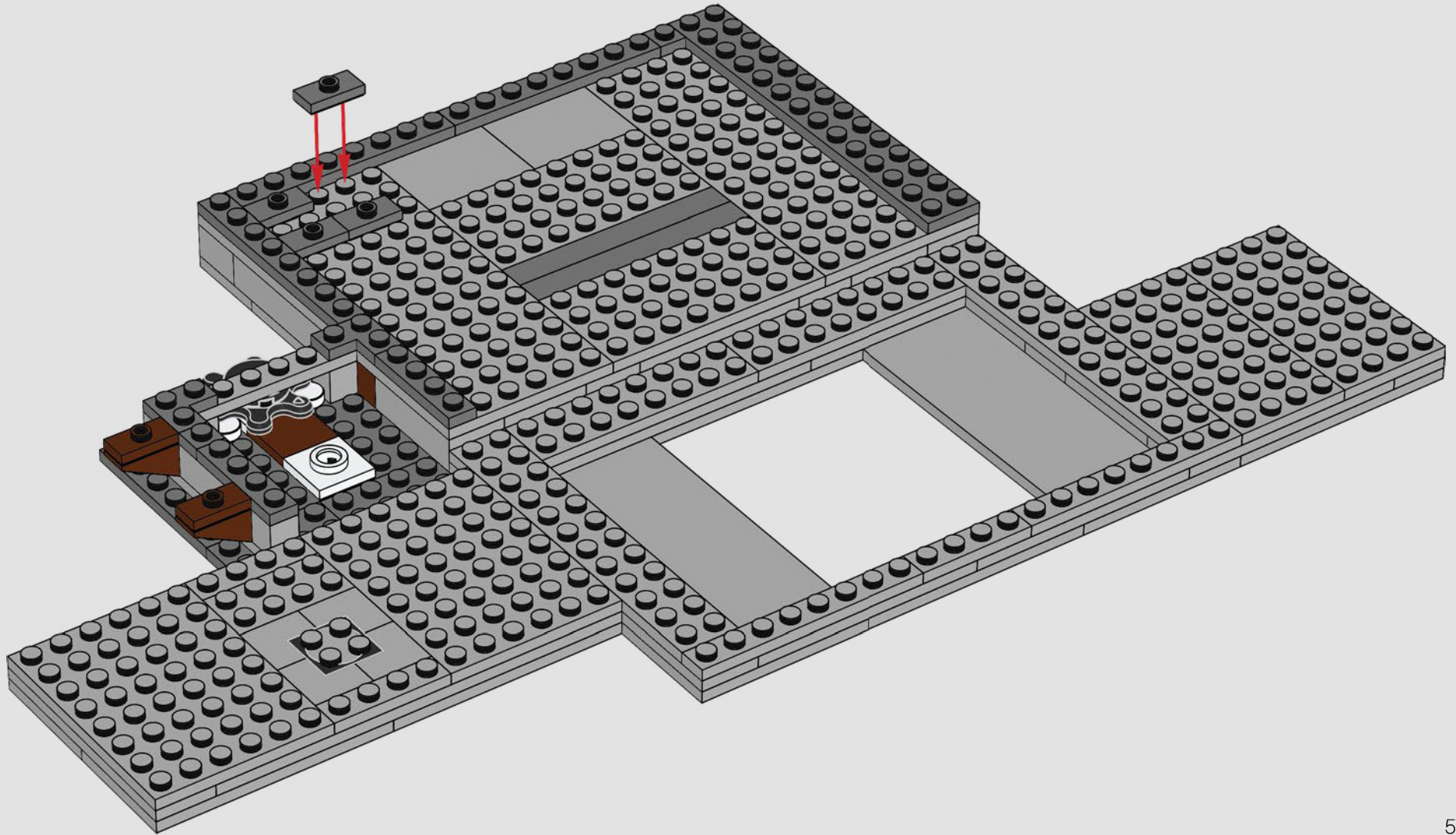

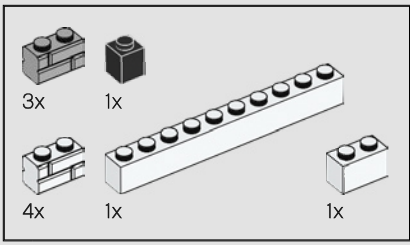

33

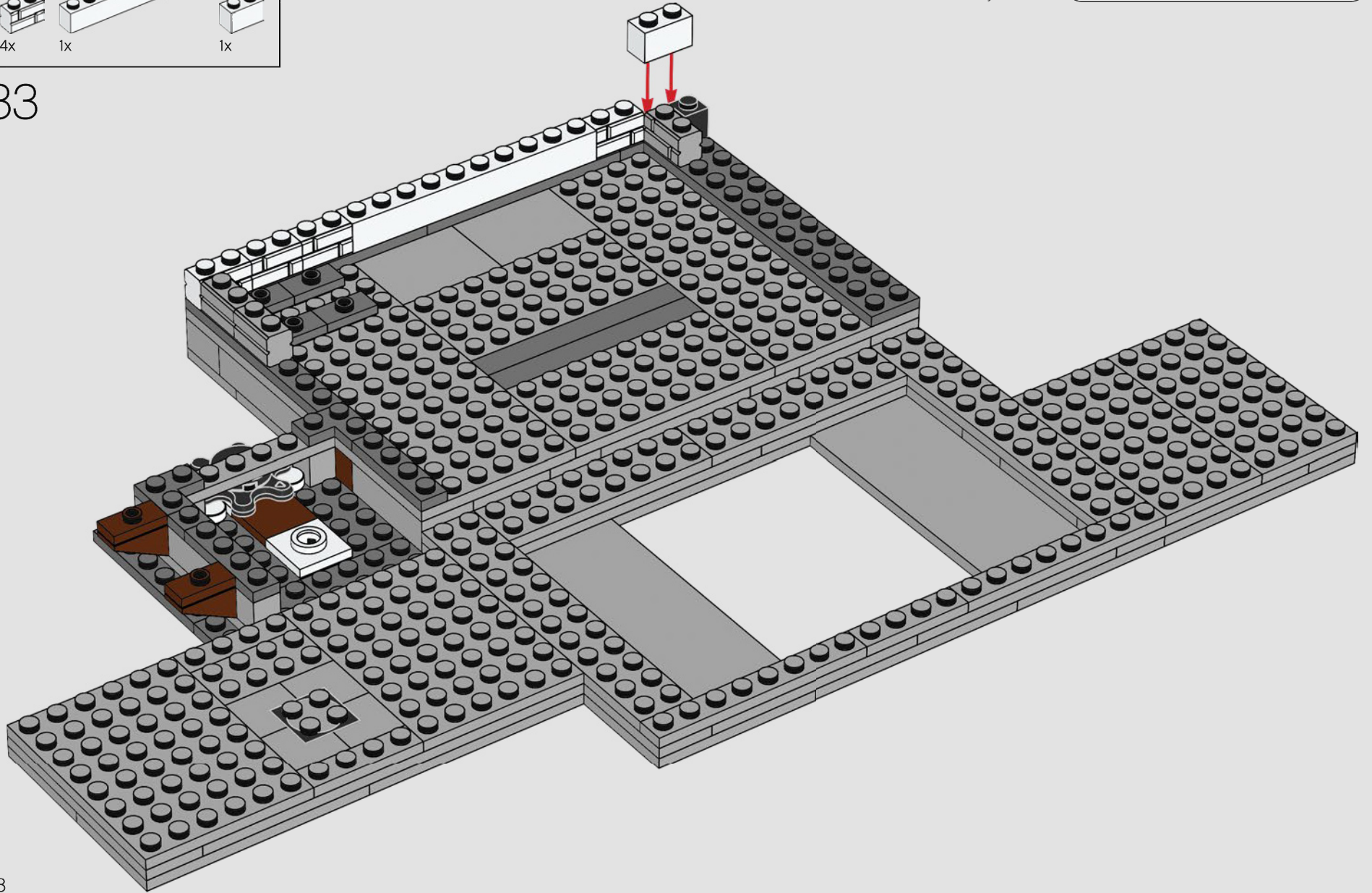

Bobby Berk

"As a child, LEGO® ignited the creative flame inside me and made me feel like the possibilities in life were just as endless as the things I was able to build."

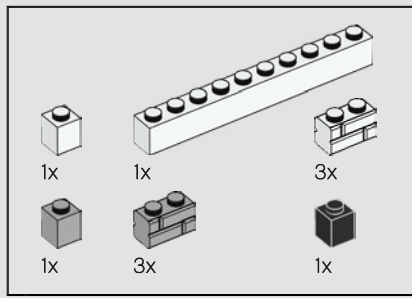

34

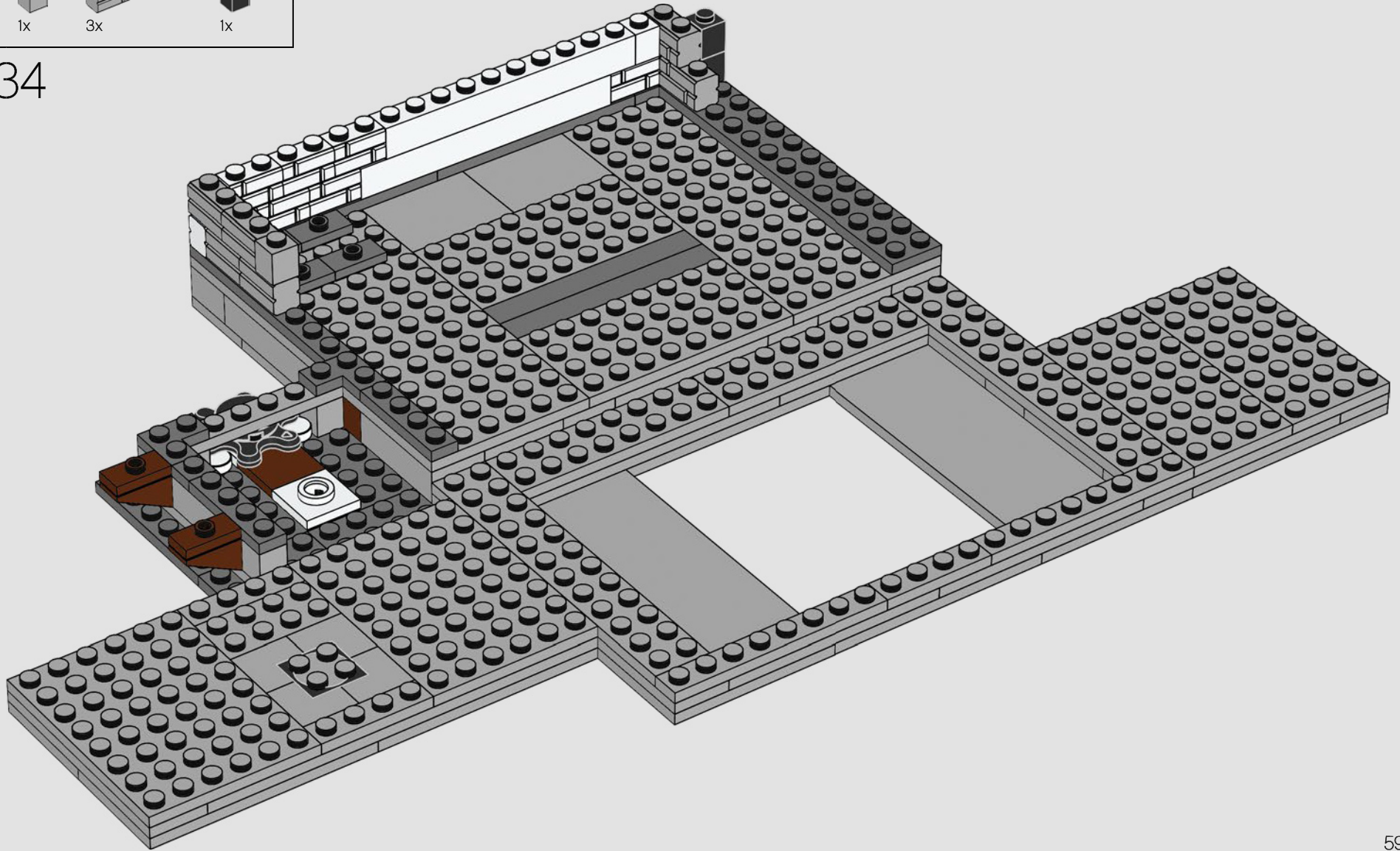

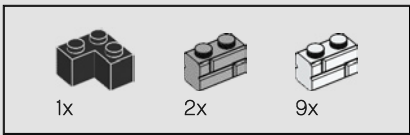

35

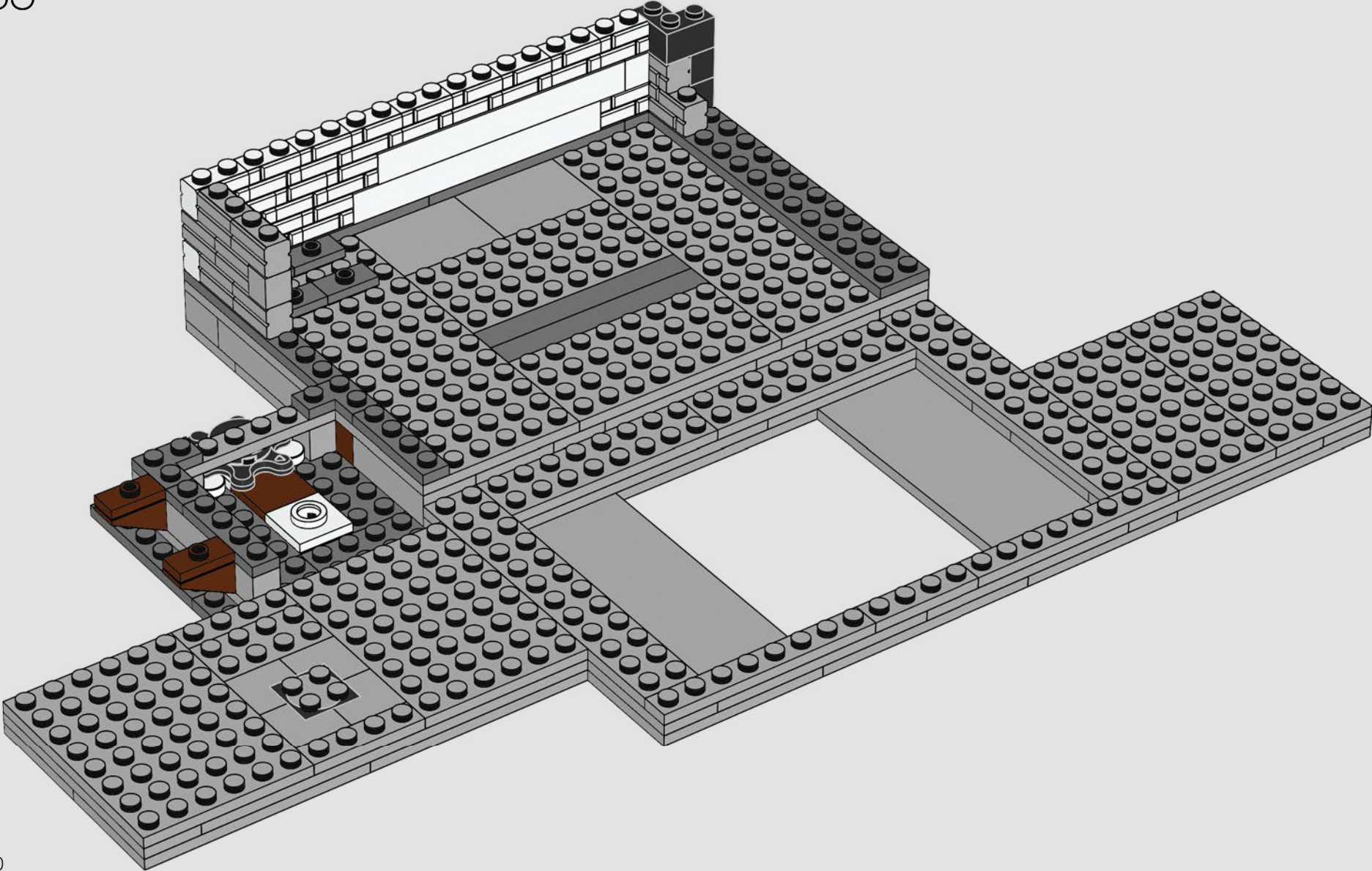

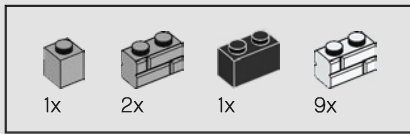

36

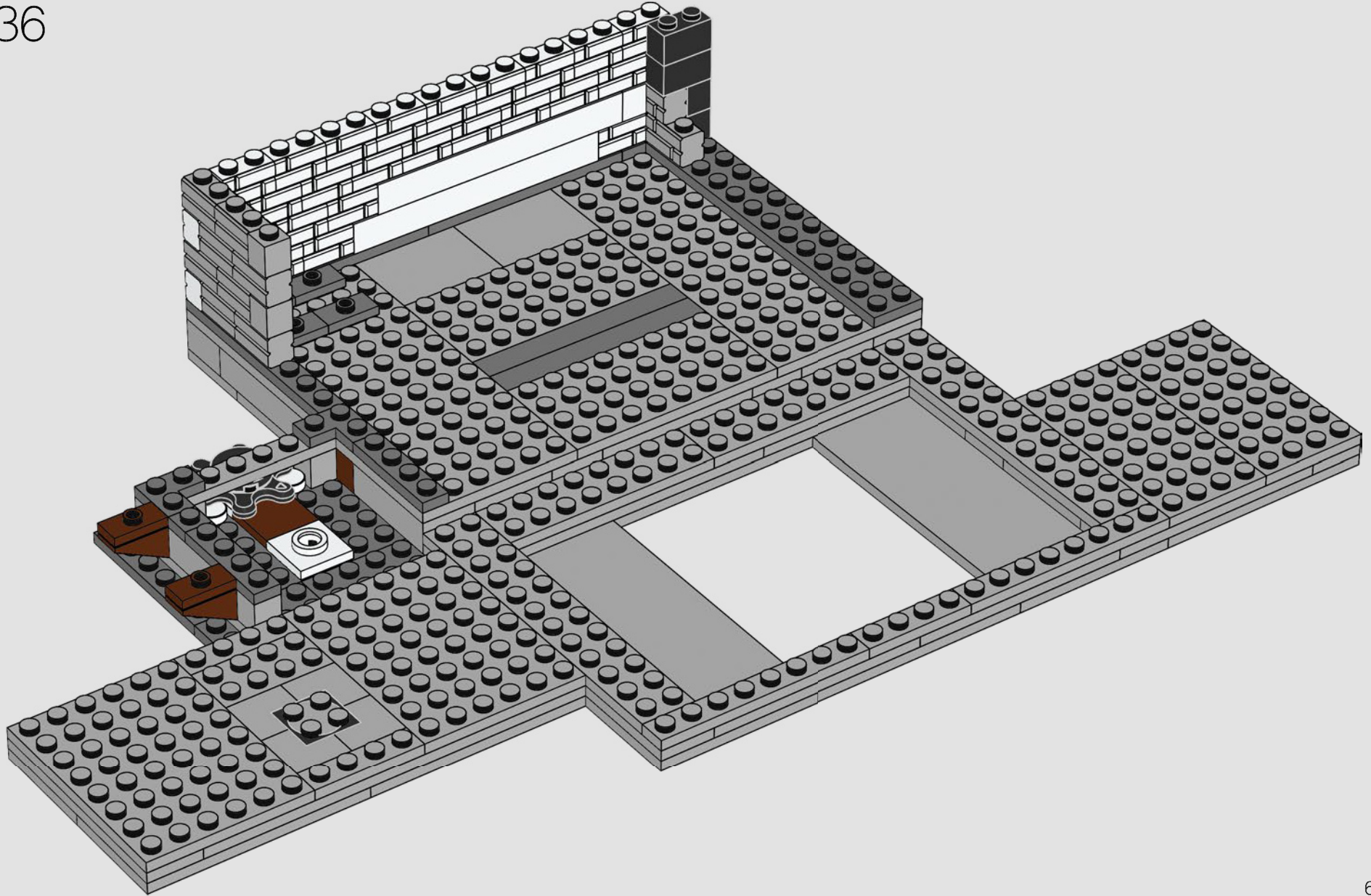

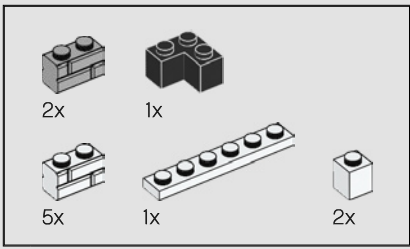

37

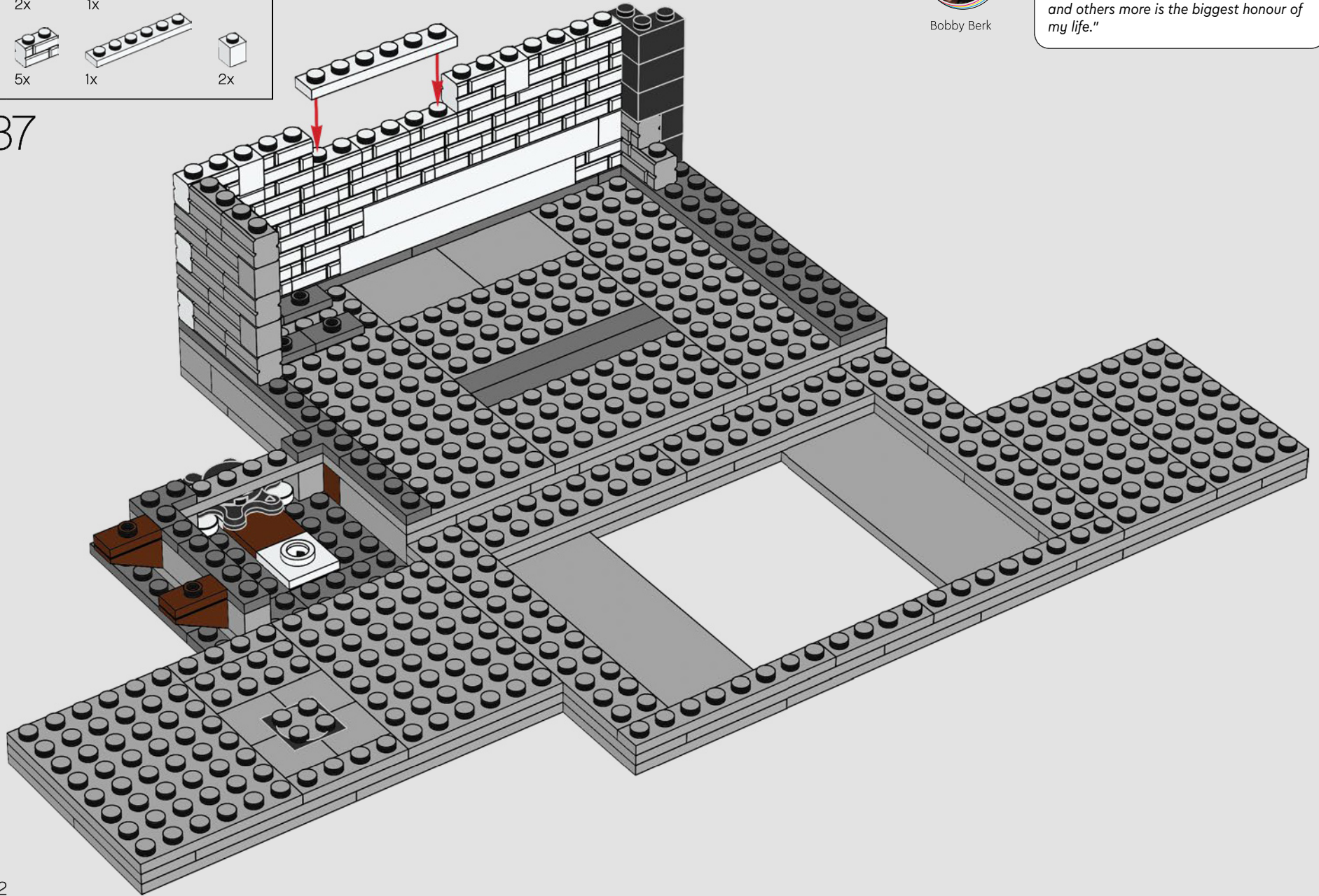

Bobby Berk

"To be able to make a show that has not only been a success but is also able to help millions of people to love themselves and others more is the biggest honour of my life."

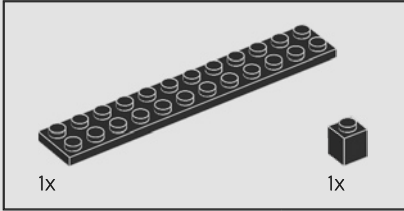
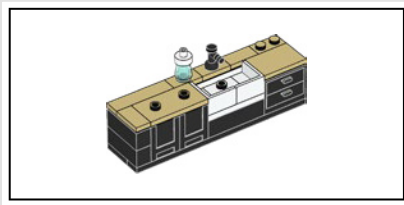

38

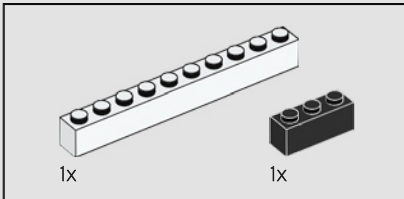
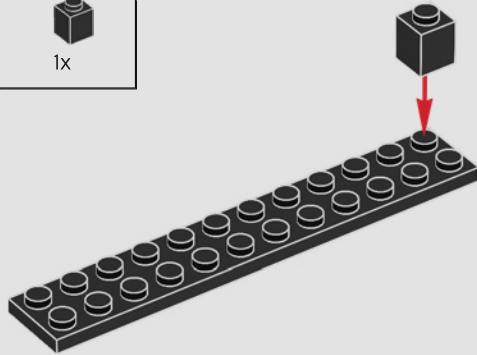

39

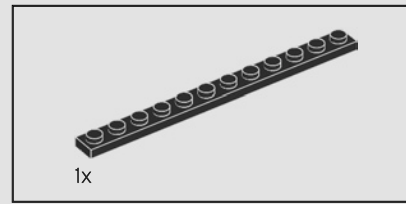
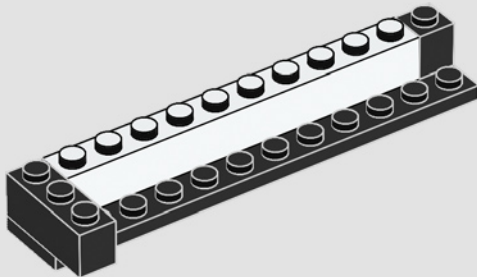

40

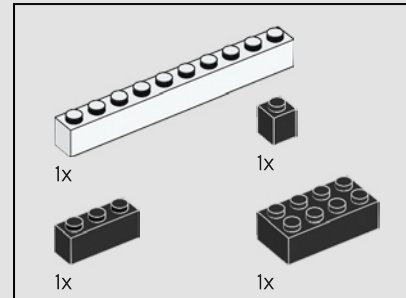
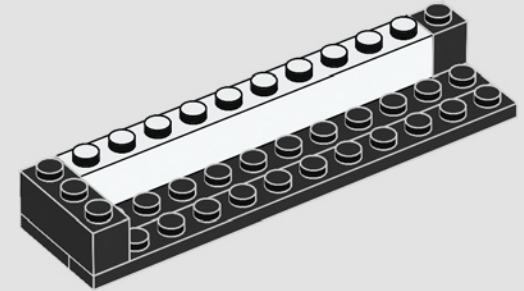

41

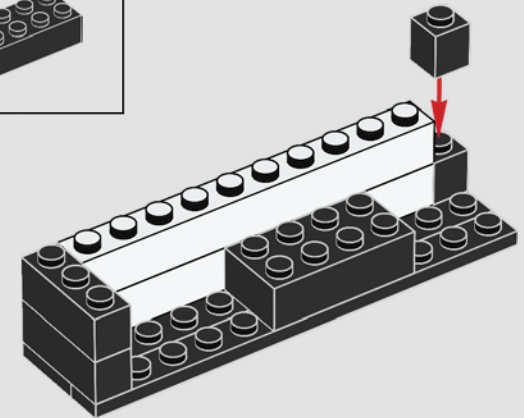



42

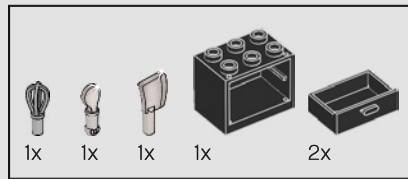
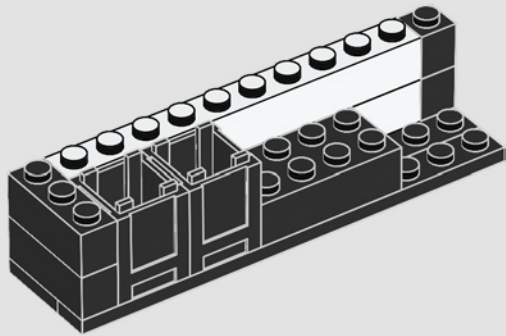

43

1

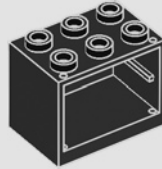

2

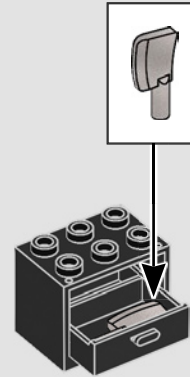

3

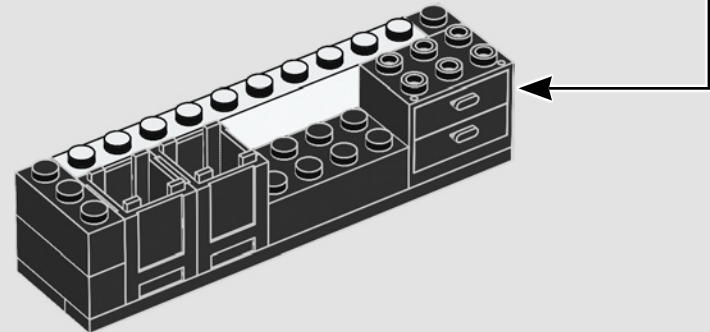
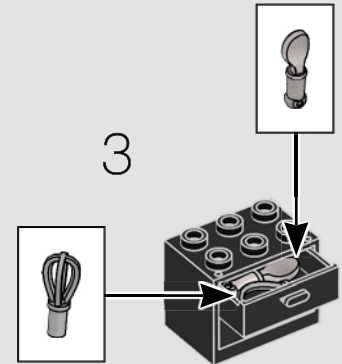

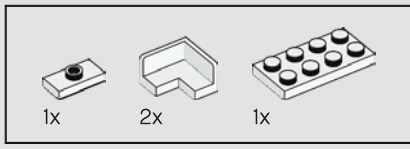

44

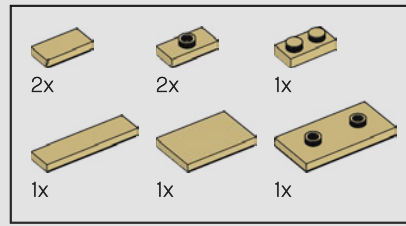
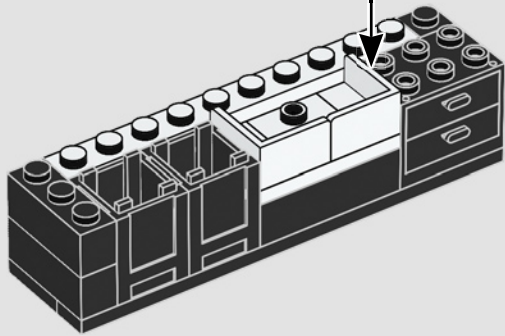
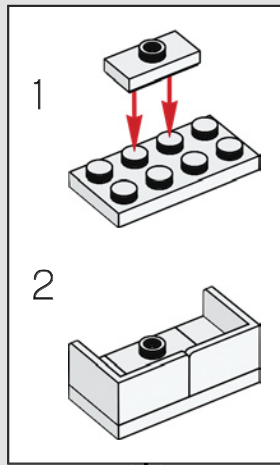

45

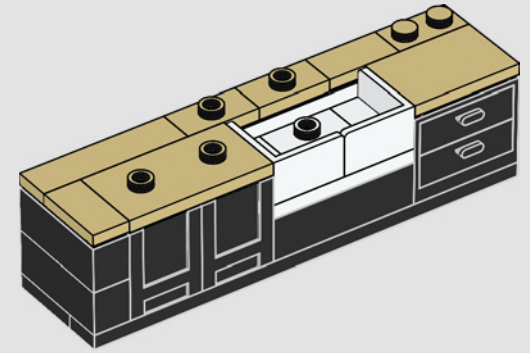

46

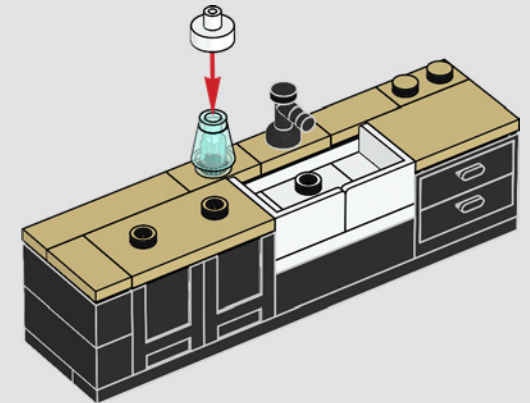

47

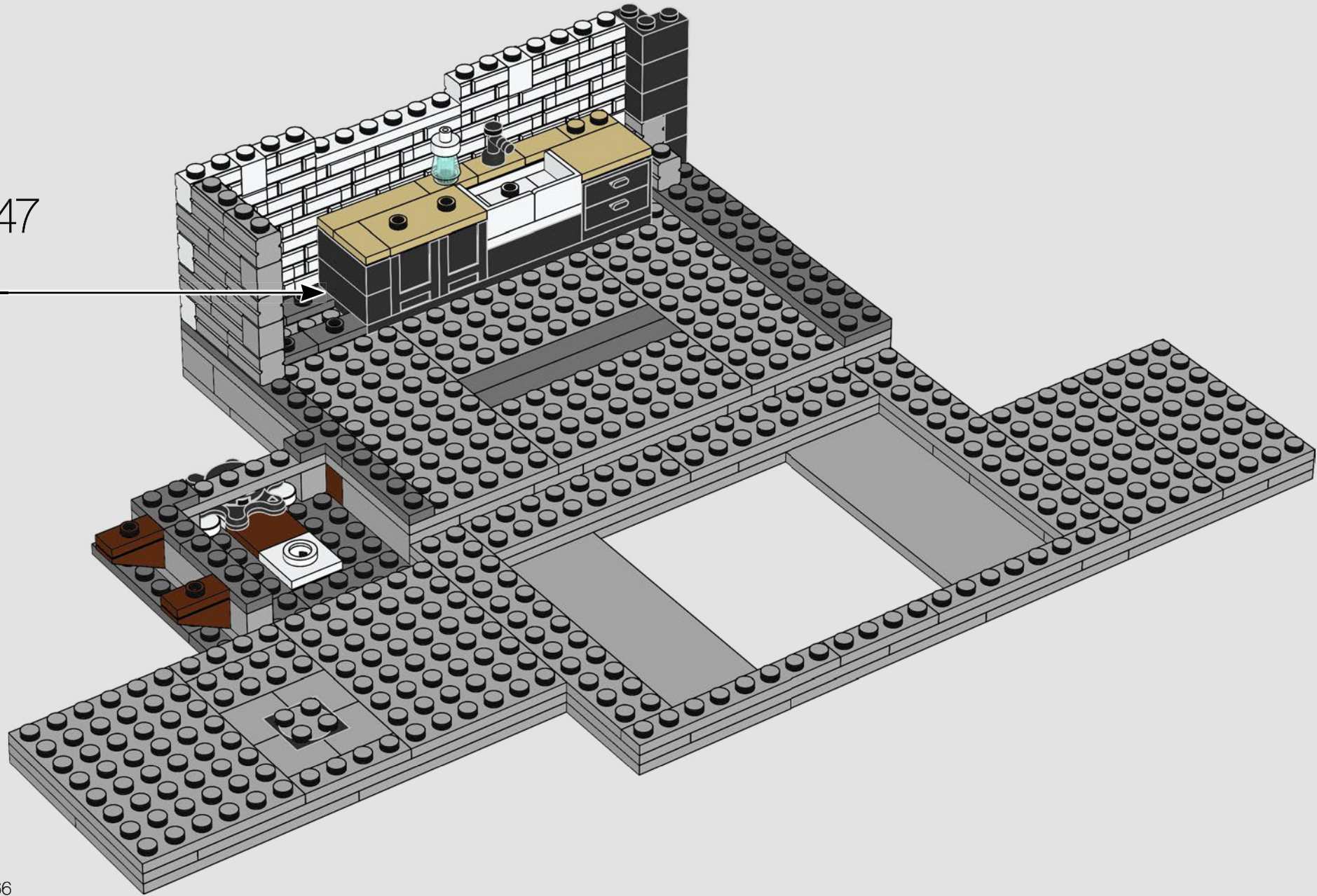

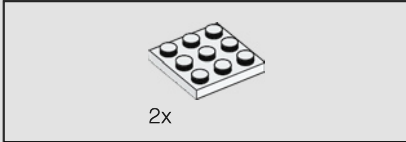
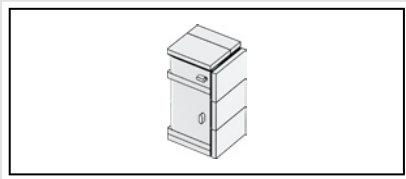

48

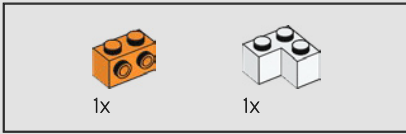
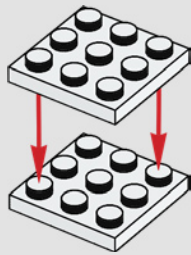

49

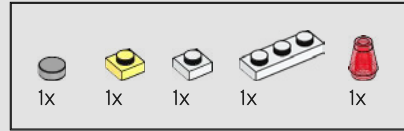
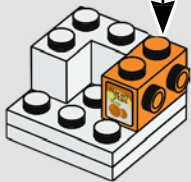
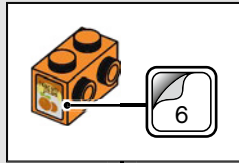

50

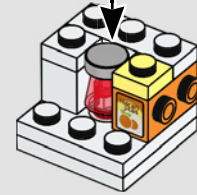
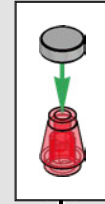

51

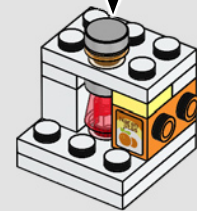
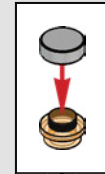

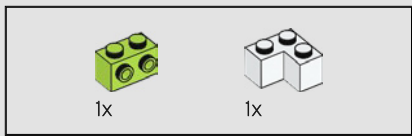

52

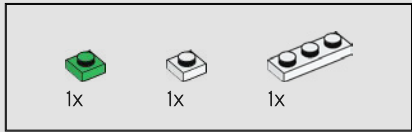
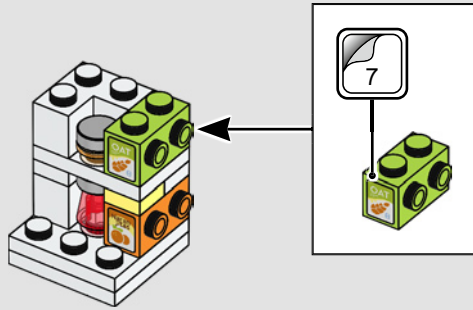

53

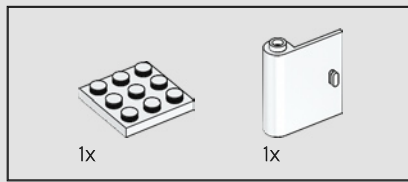

54

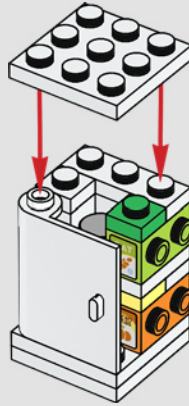

55

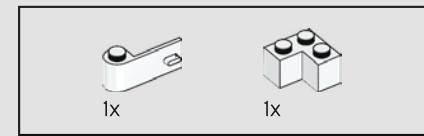
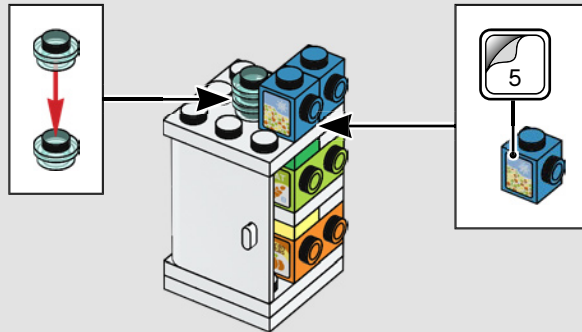

56

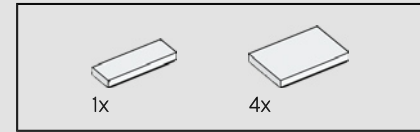

57

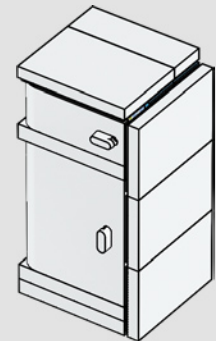

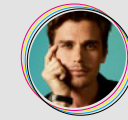

Antoni Porowski

"Building with LEGO® is in some ways very much like cooking a meal. Of course, you can follow the recipe to make the perfect 'tried and tested' end result, or you can get all experimental and come up with your own creation."



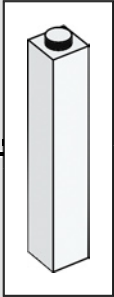
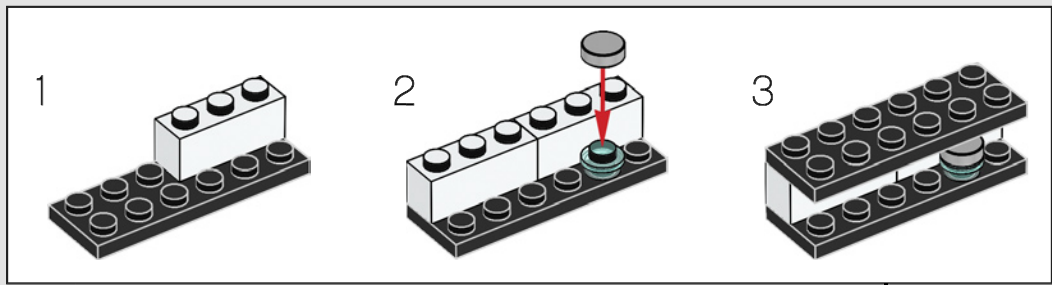
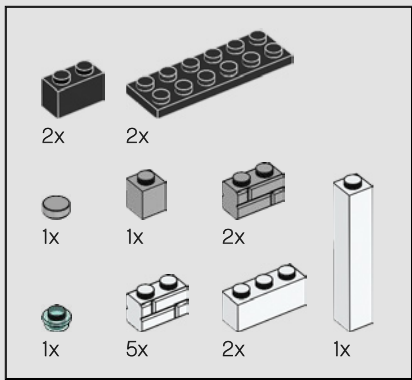

59

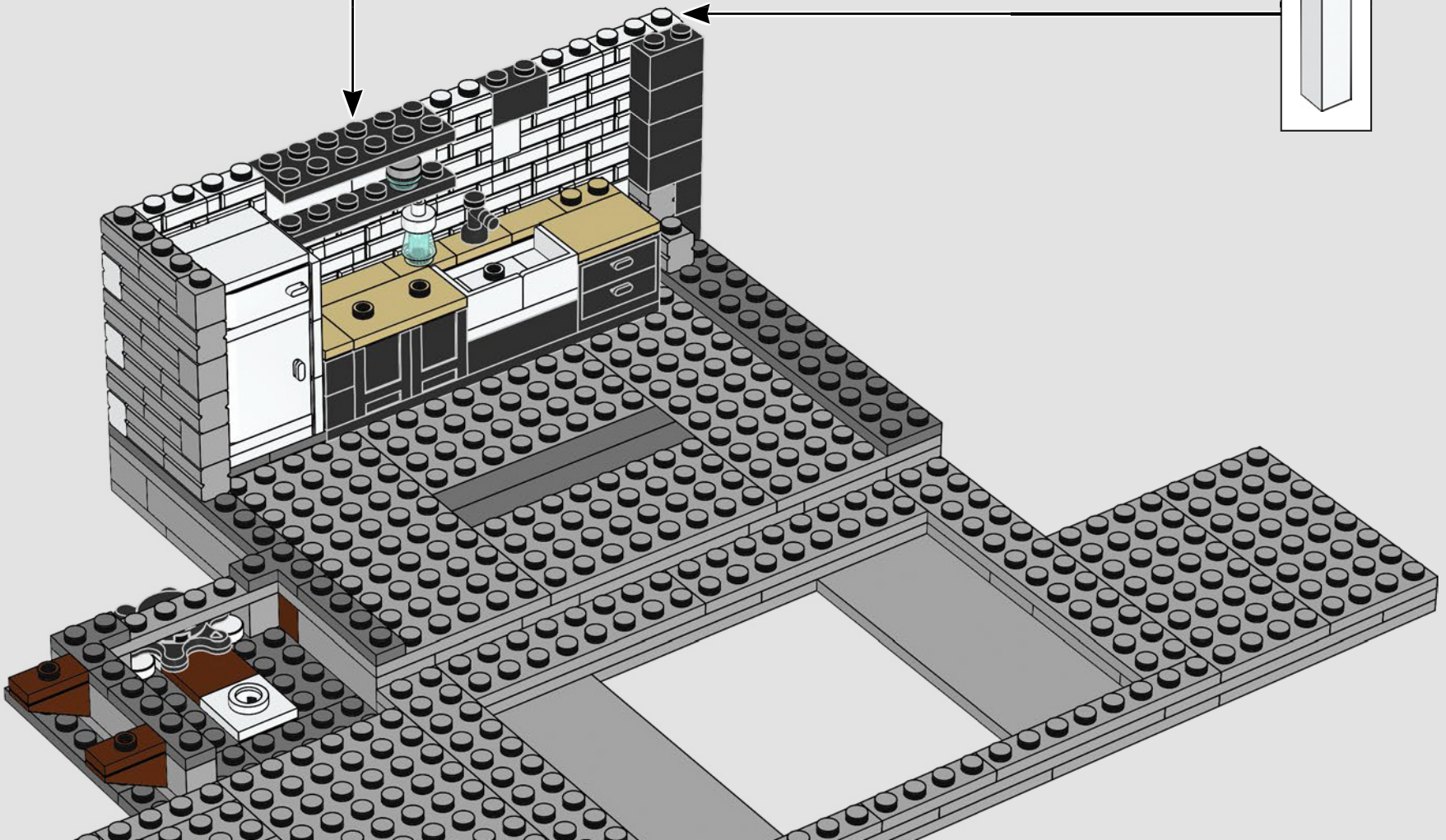

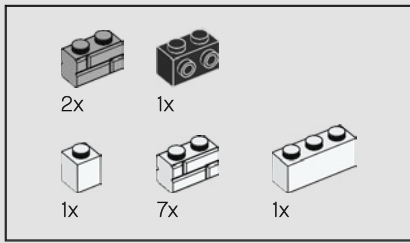

60

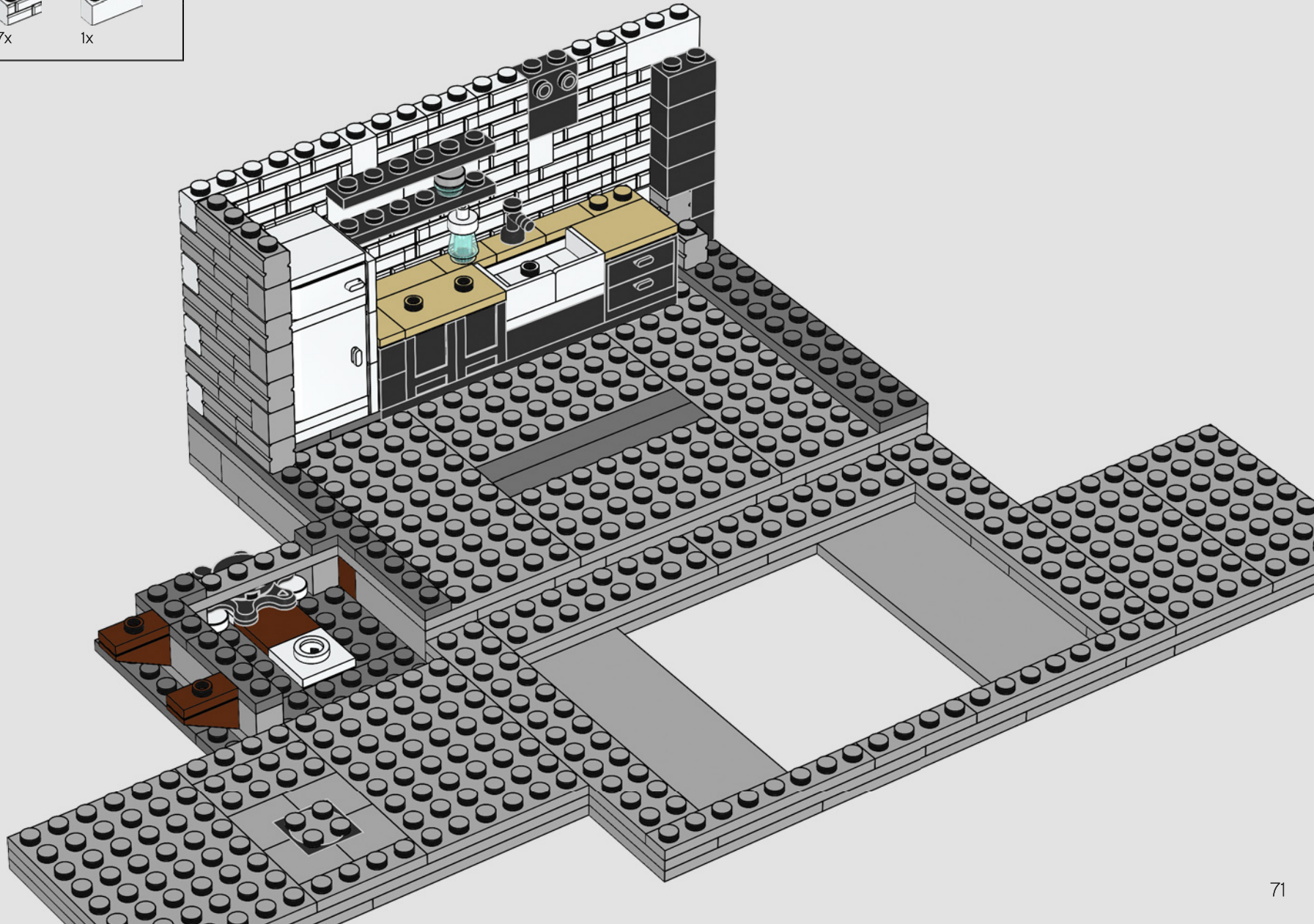

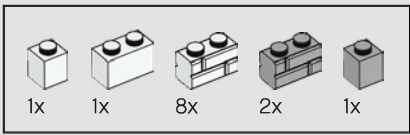

61



Bobby Berk

"On Queer Eye we're all about fresh starts, re-building, and making the best of what you've got - and what better toy is there to celebrate that than LEGO?"



72



62

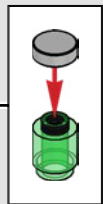
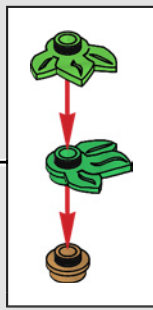
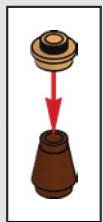
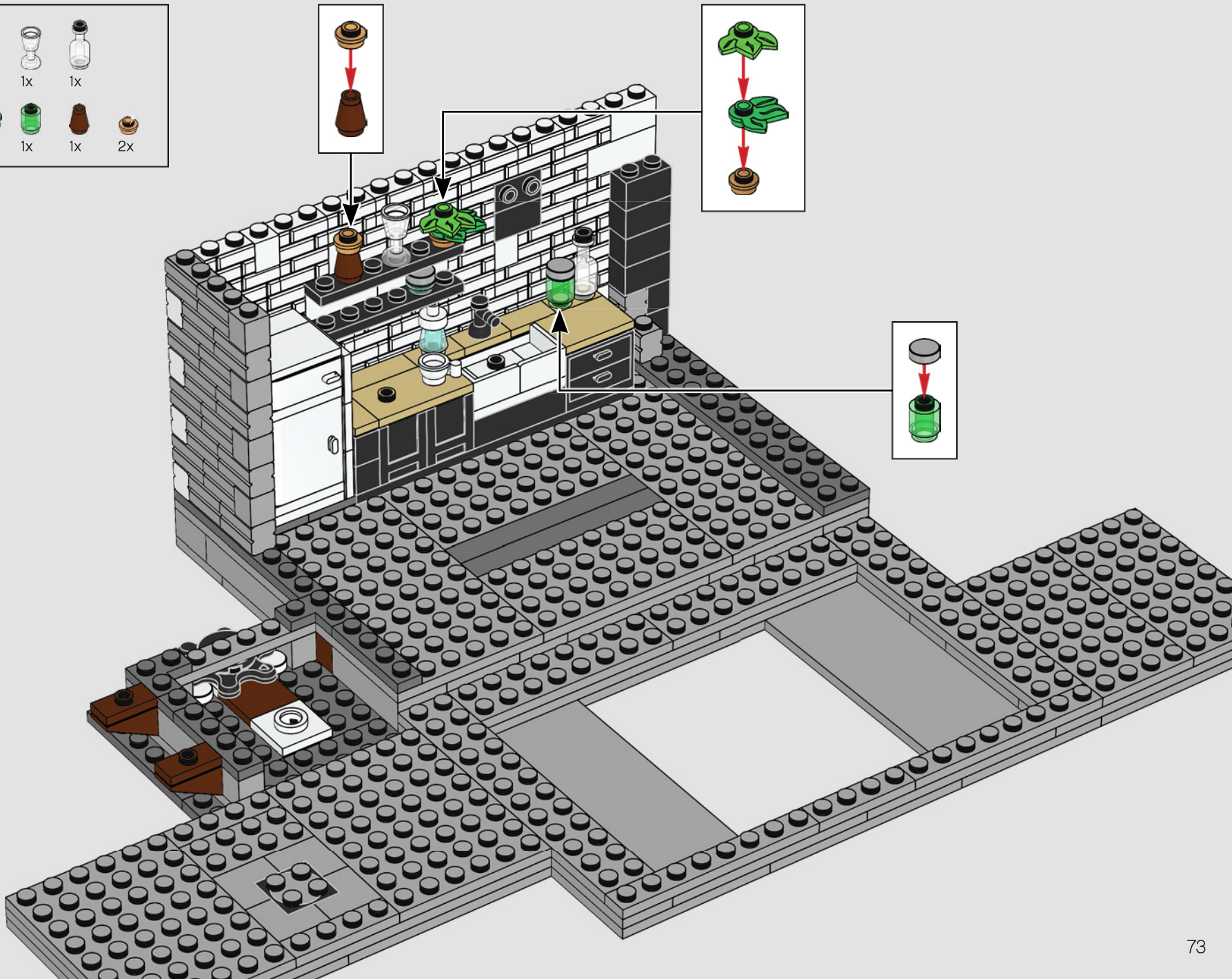

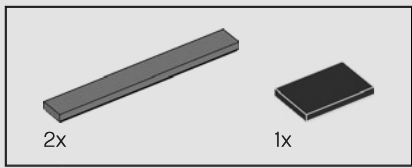

63

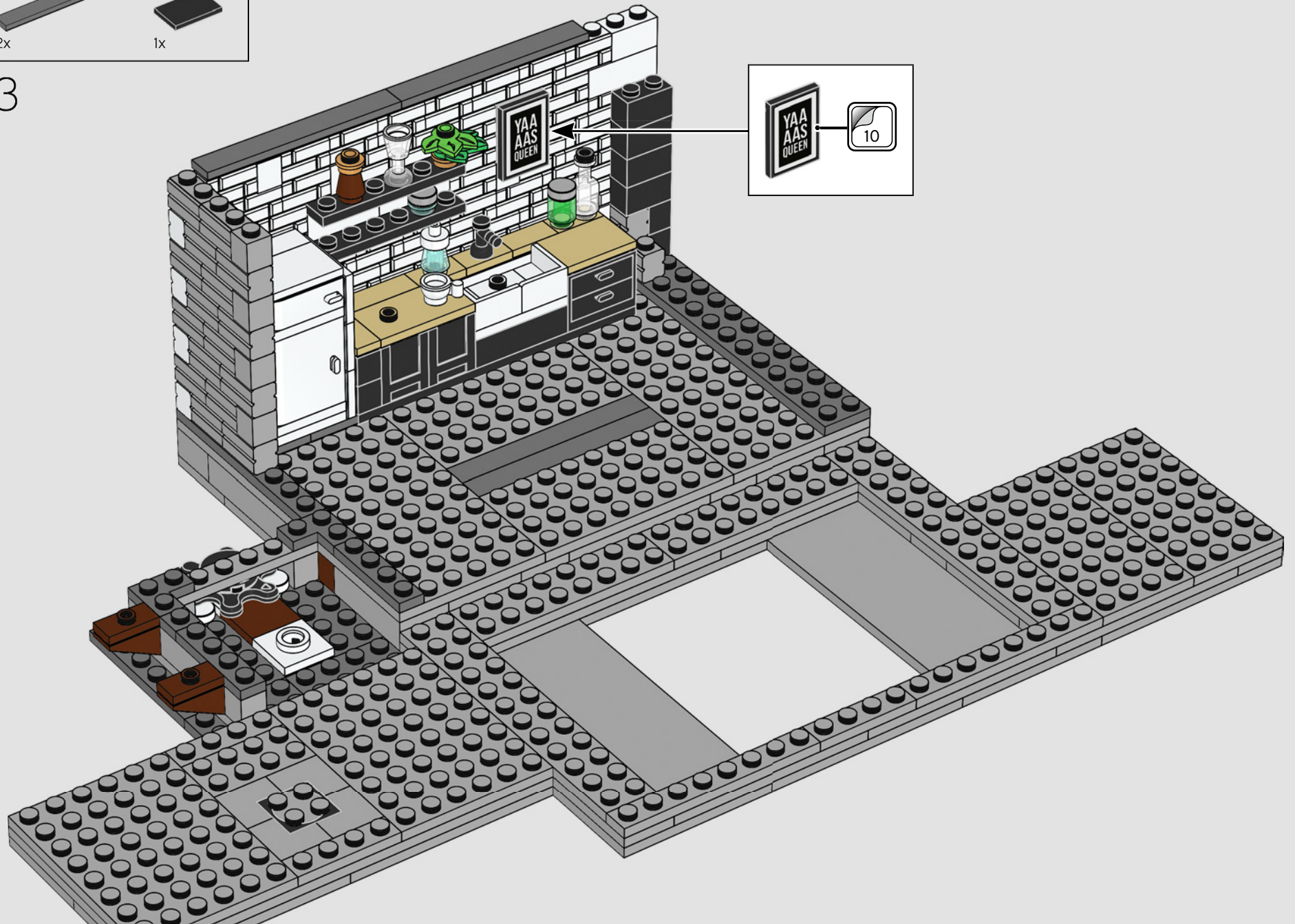

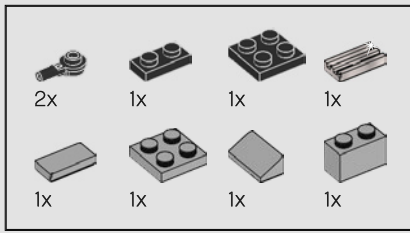

64

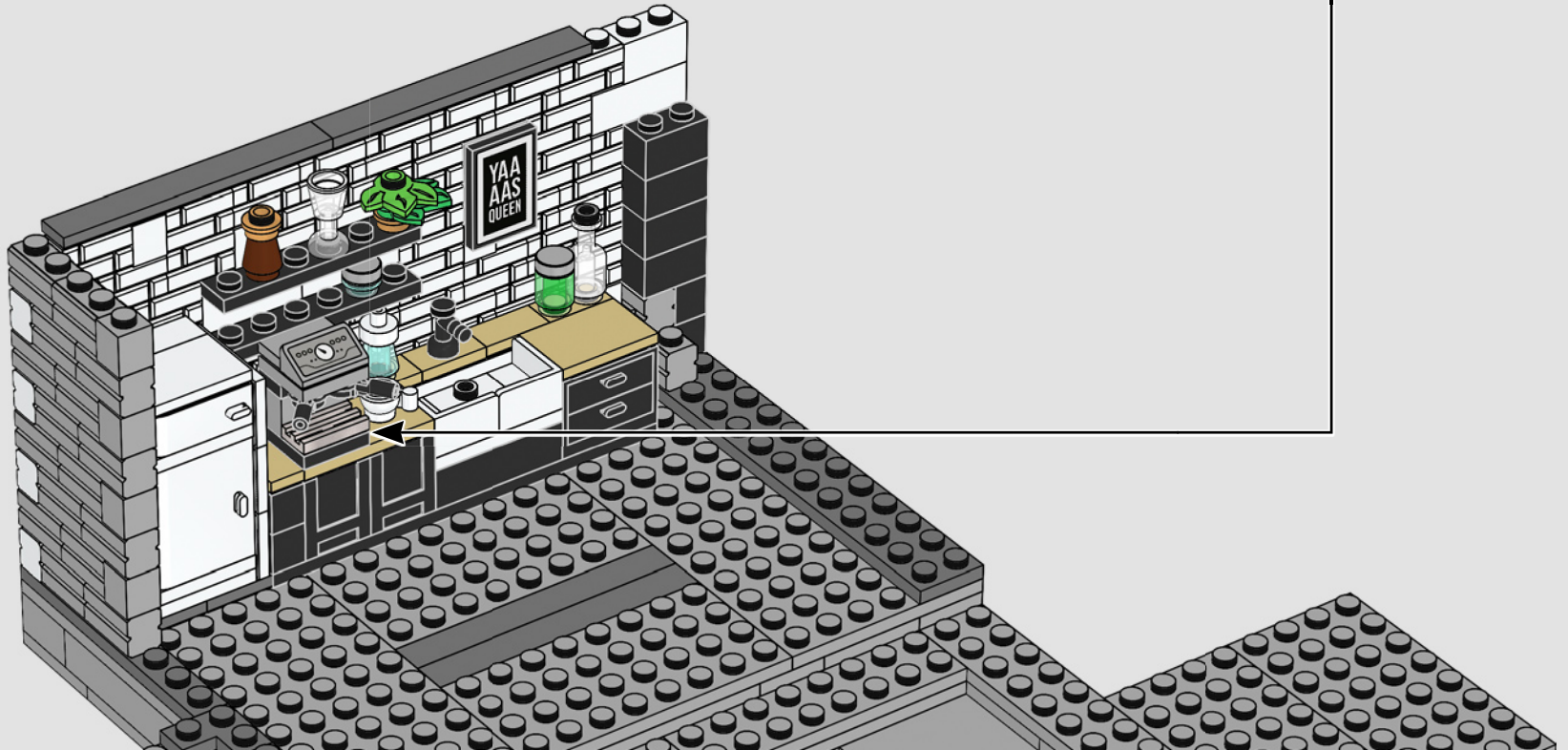
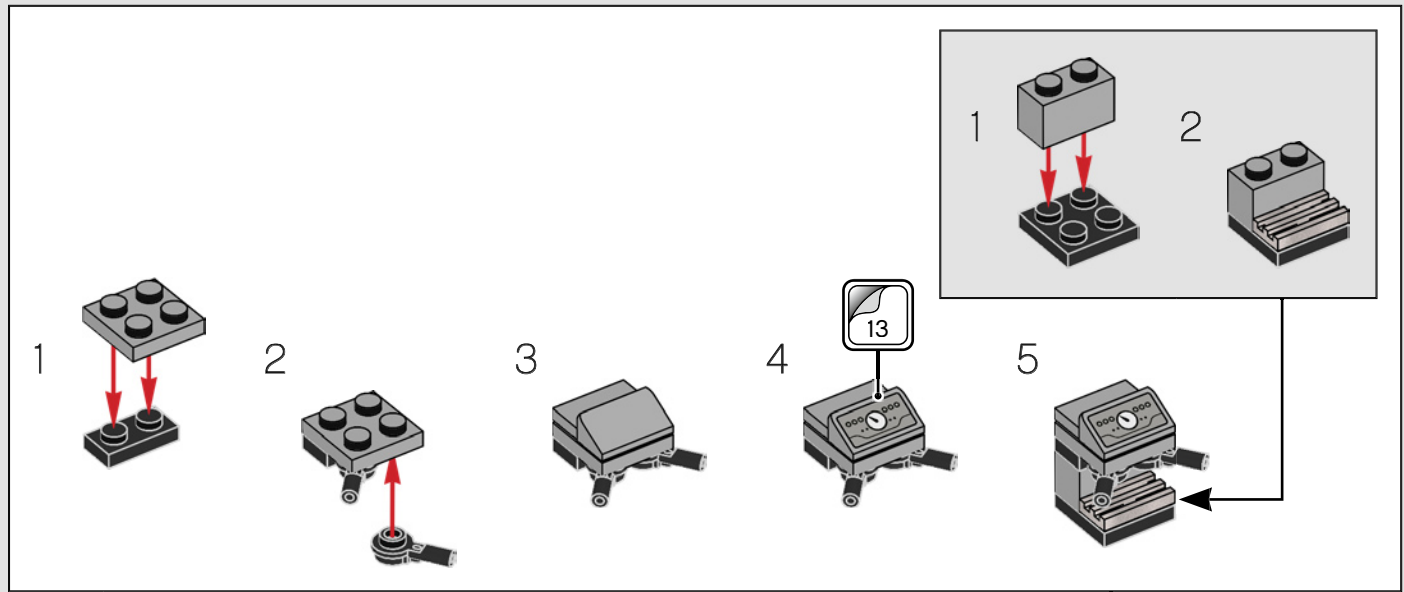

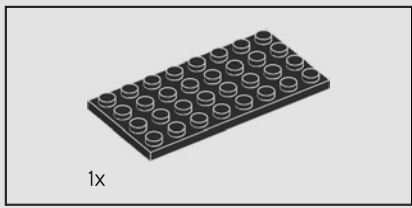

65

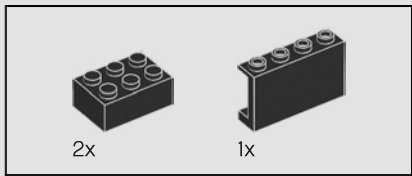
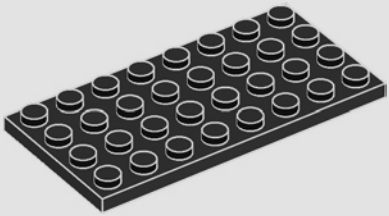

66

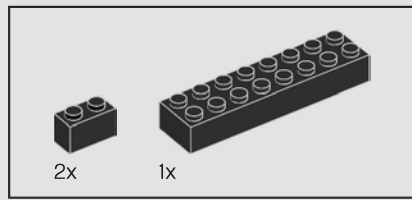
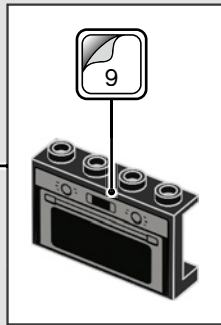
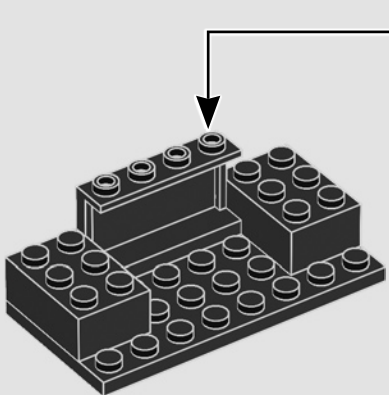

67

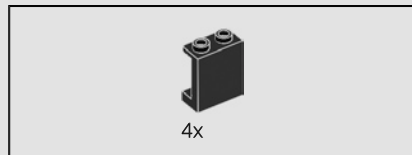
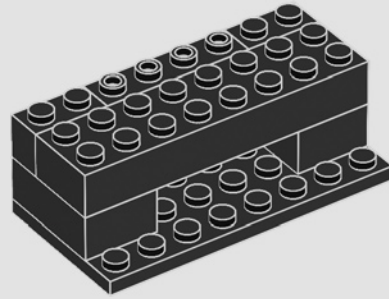

68

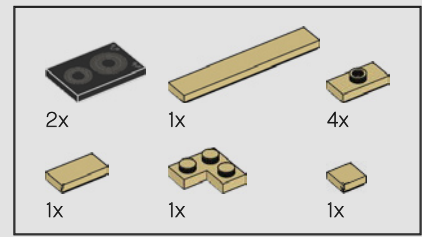
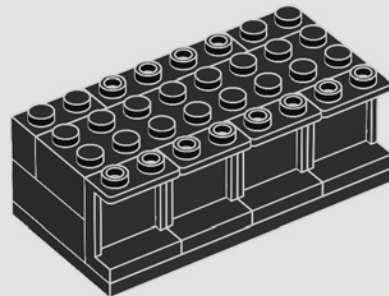

69

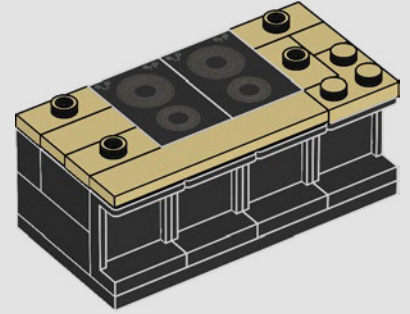

70

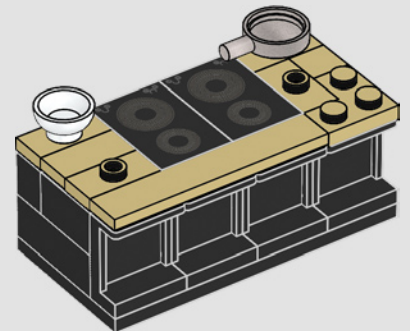

71

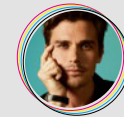
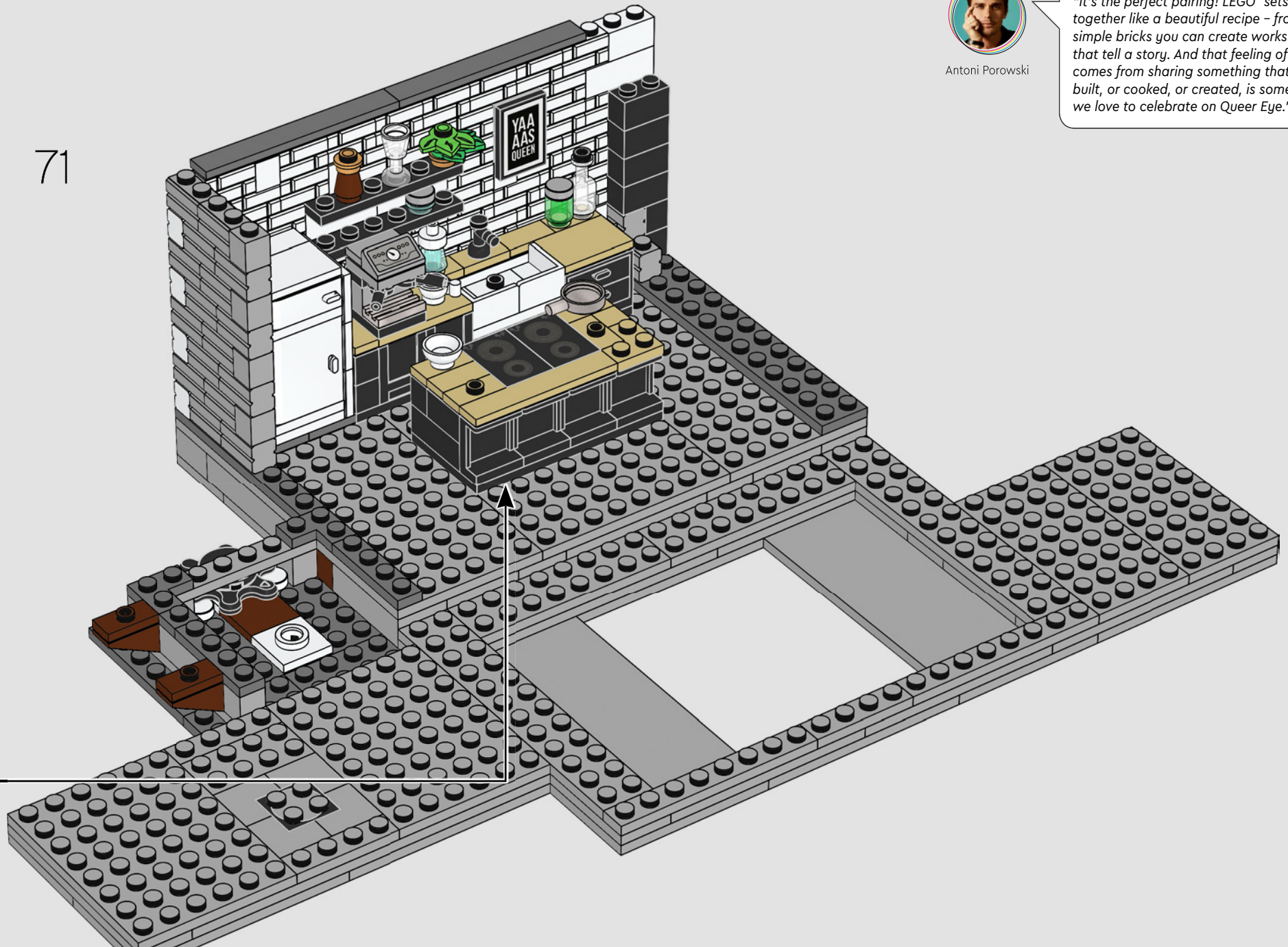

Antoni Porowski

"It's the perfect pairing! LEGO® sets come together like a beautiful recipe - from these simple bricks you can create works of art that tell a story. And that feeling of joy that comes from sharing something that you've built, or cooked, or created, is something we love to celebrate on Queer Eye."

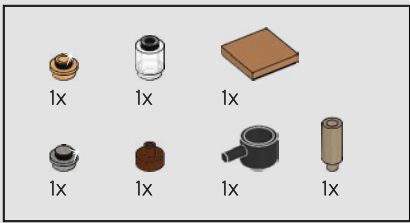

72

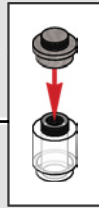
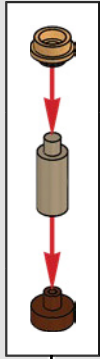
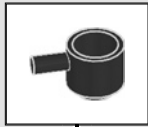
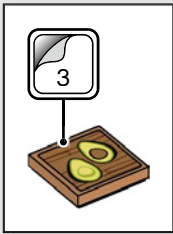

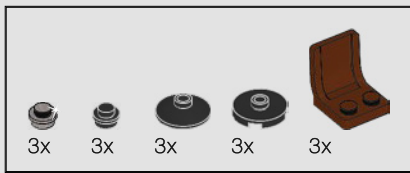

73

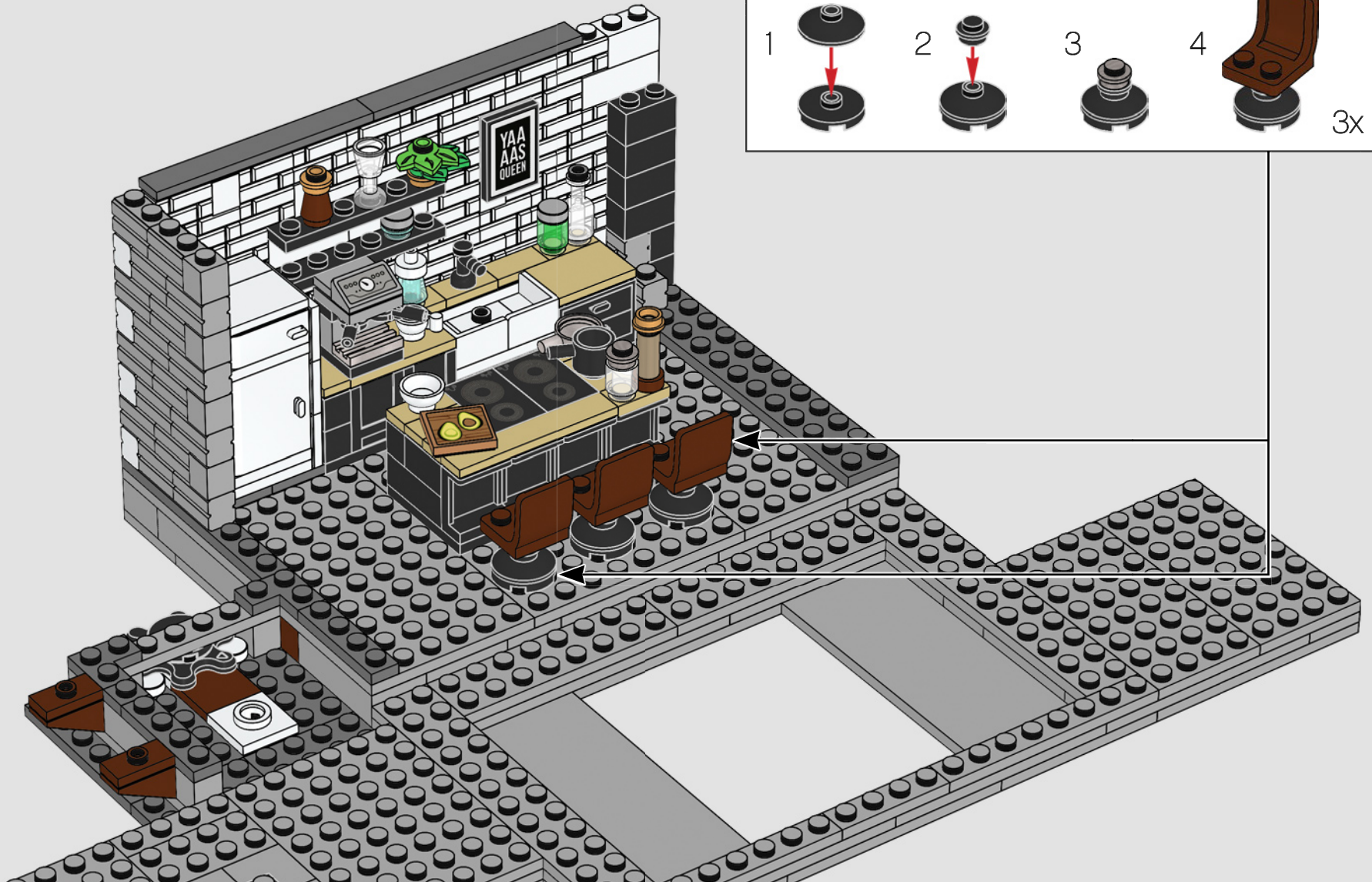
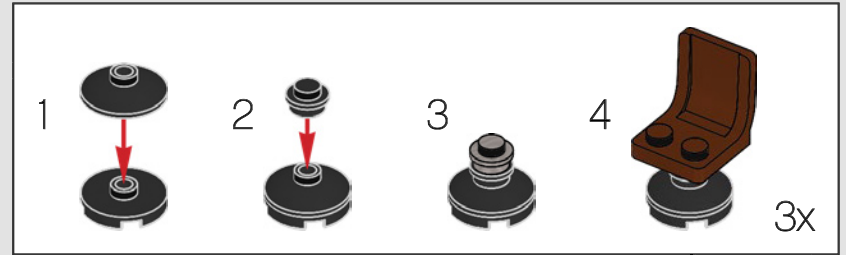

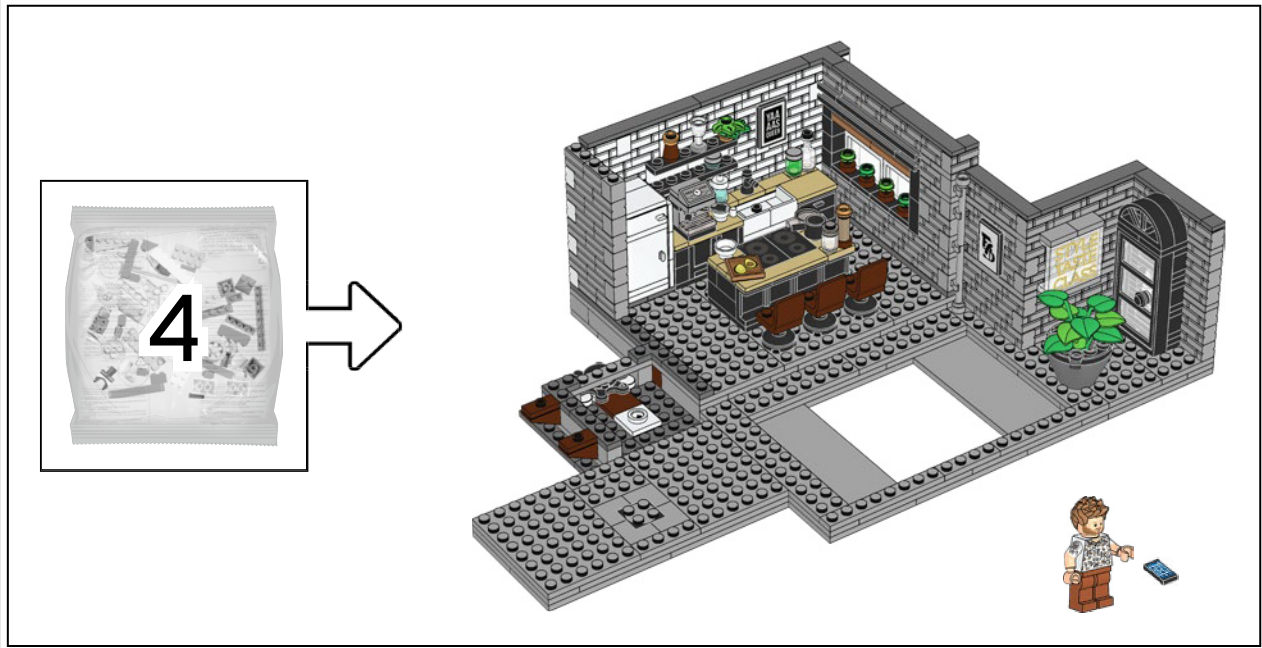

Bobby Berk

*"It's so surreal seeing myself in LEGO®
Minifigure form – 7-year-old me would be
mind-blown to know this was a thing!"*



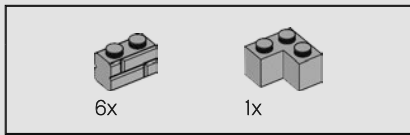

74



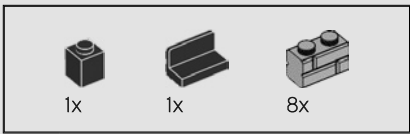

75

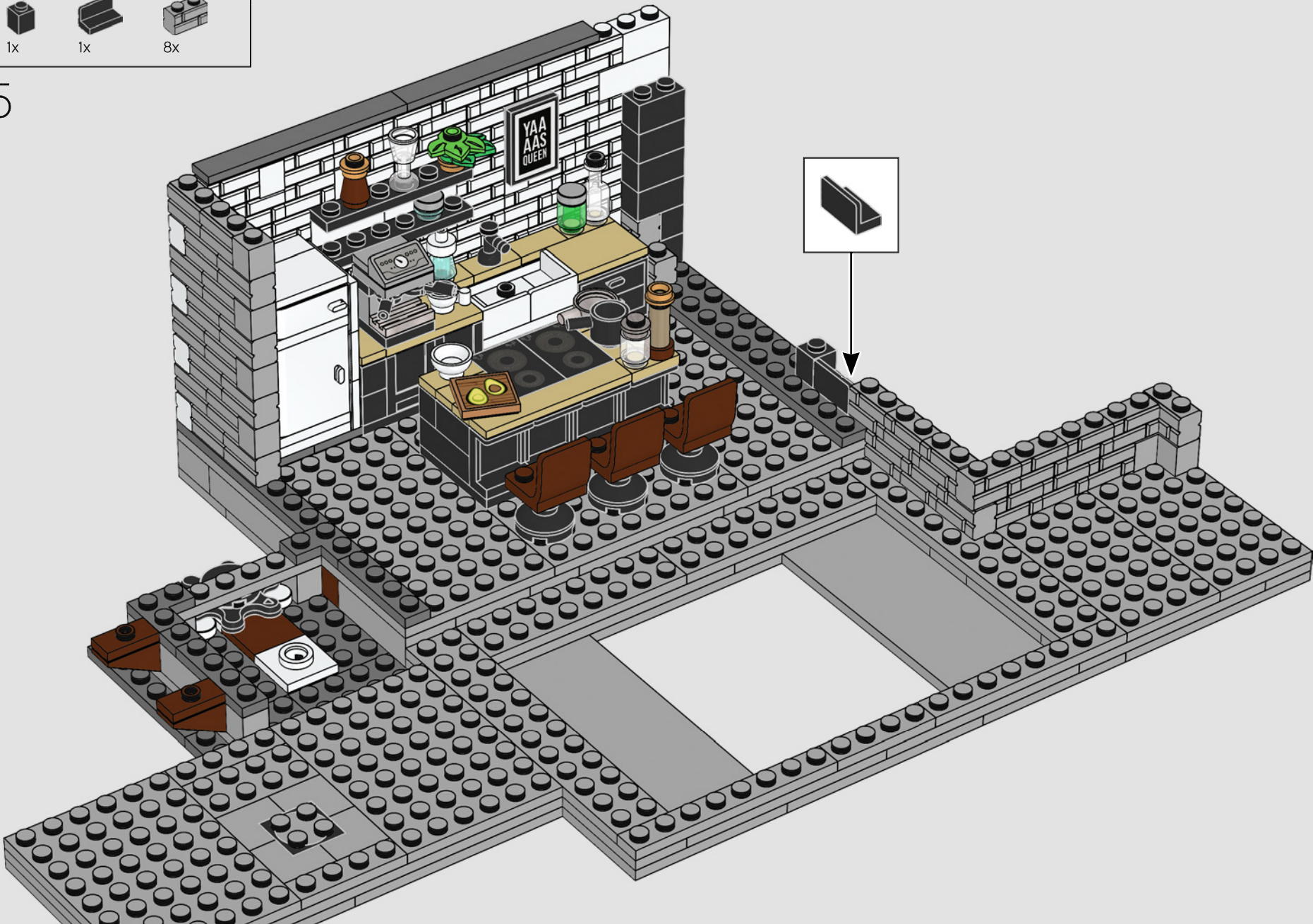

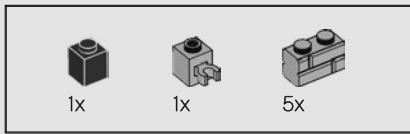

76

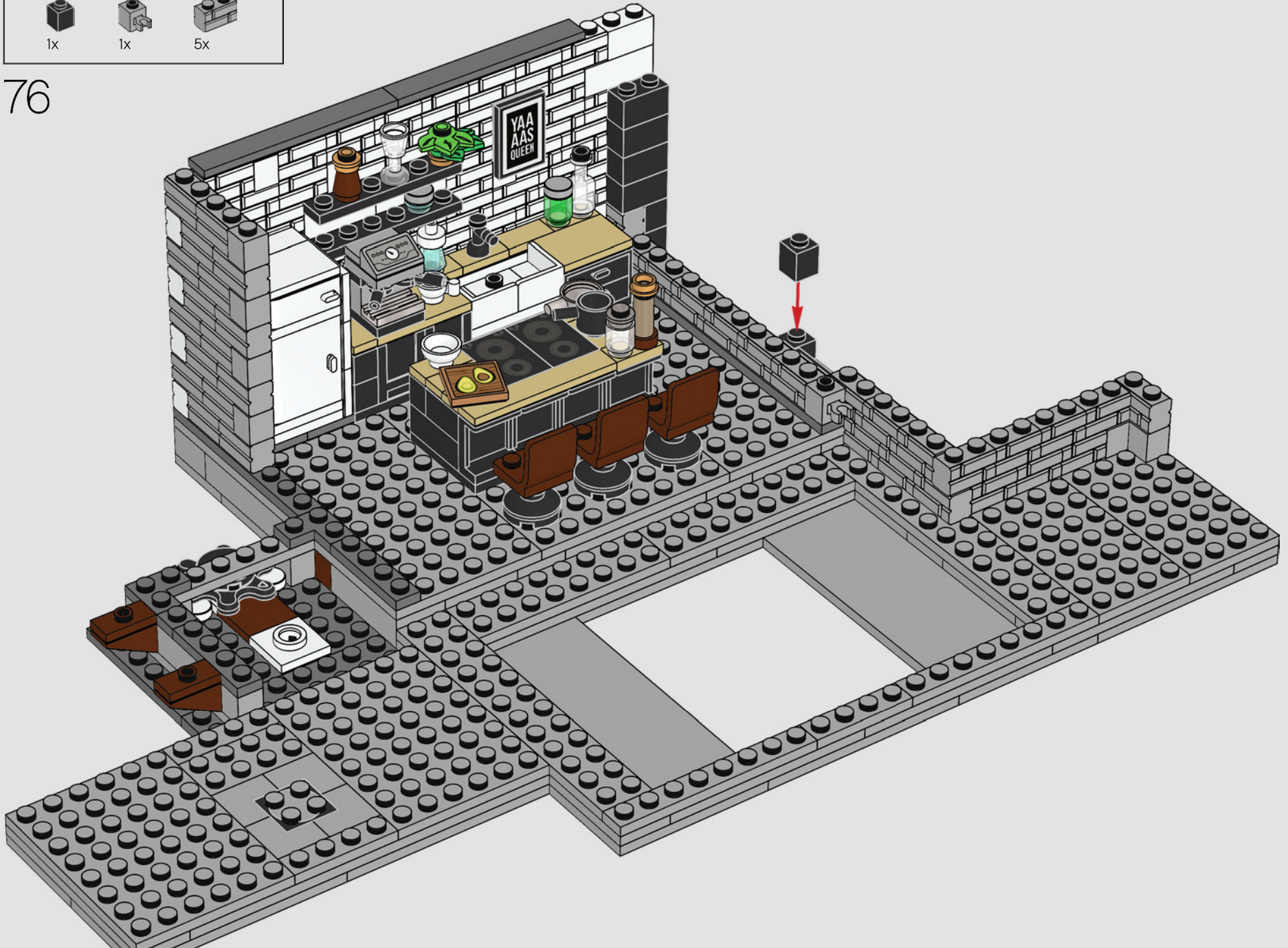

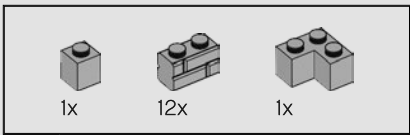

77

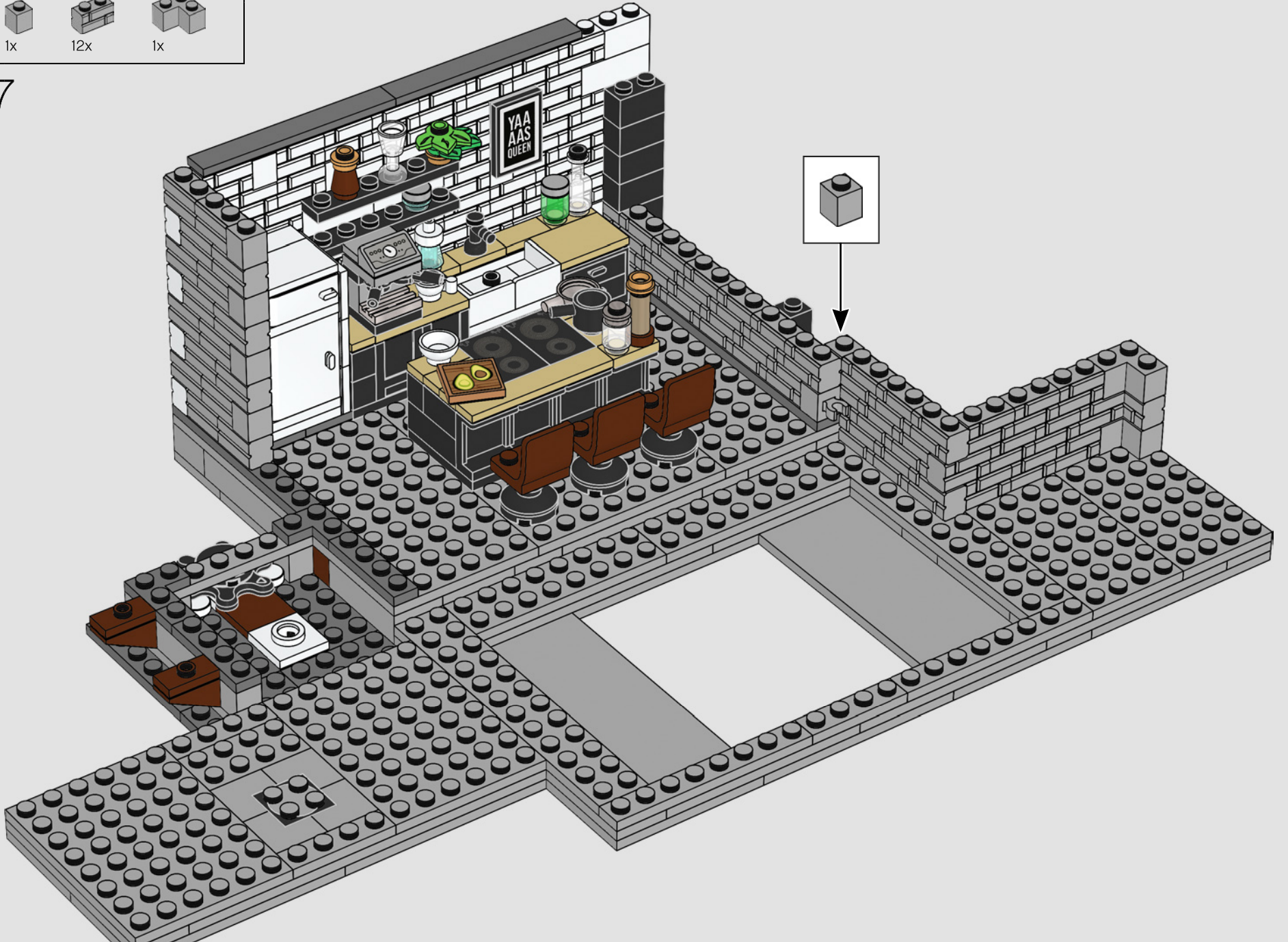



78

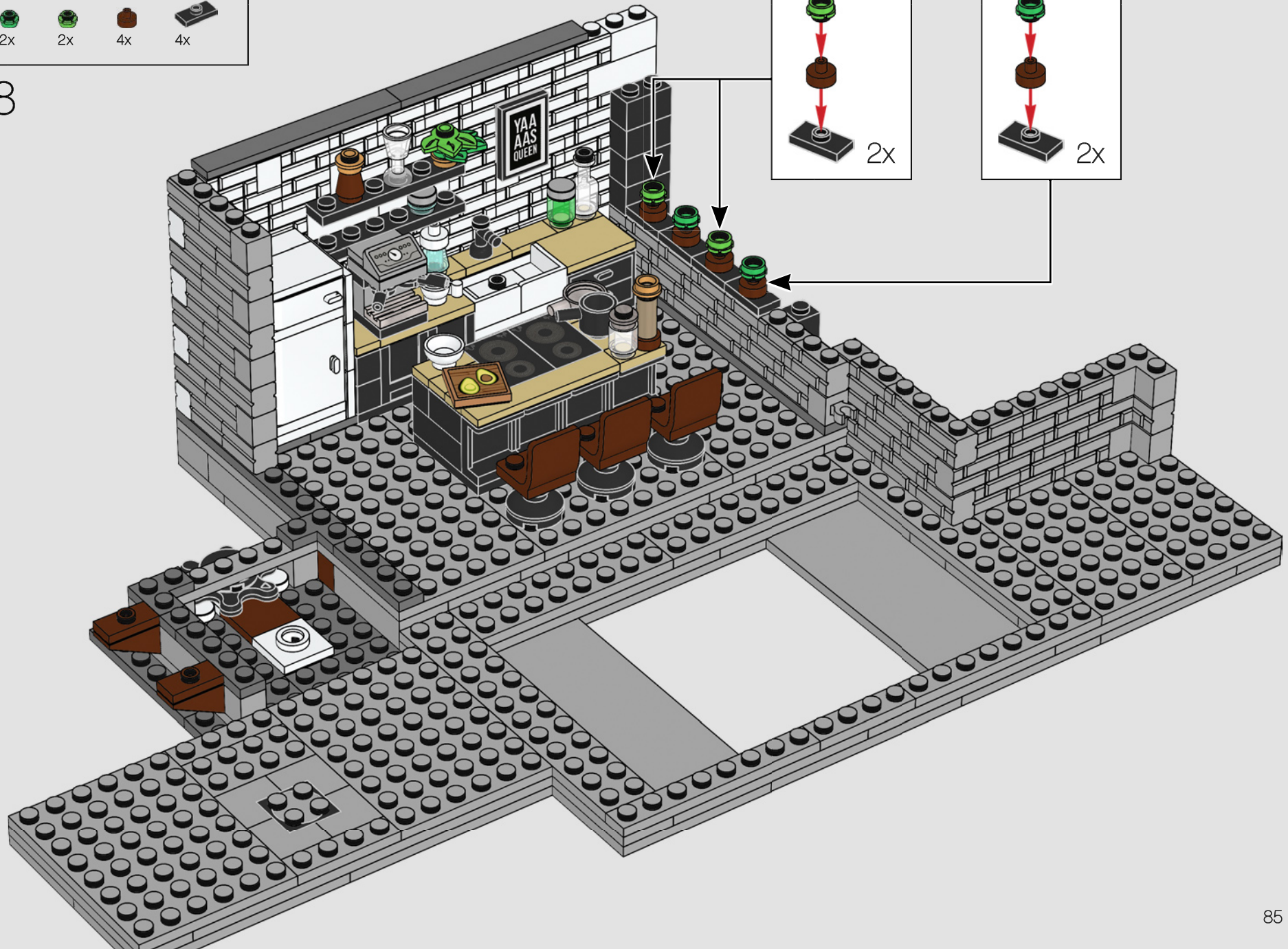
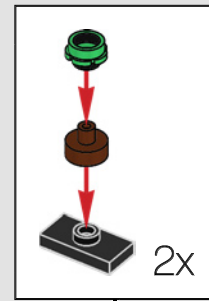
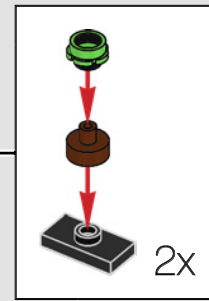

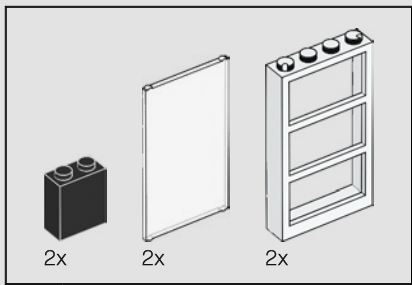

79

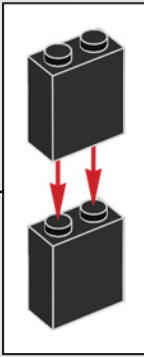
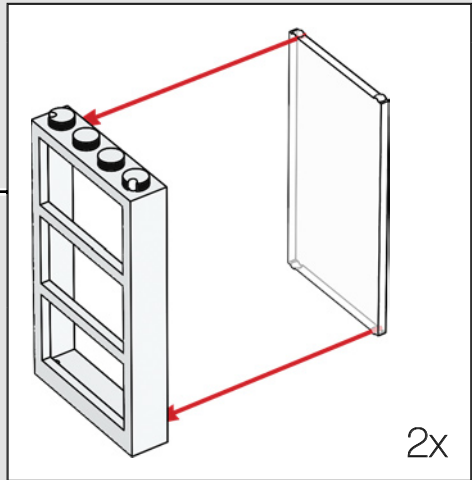
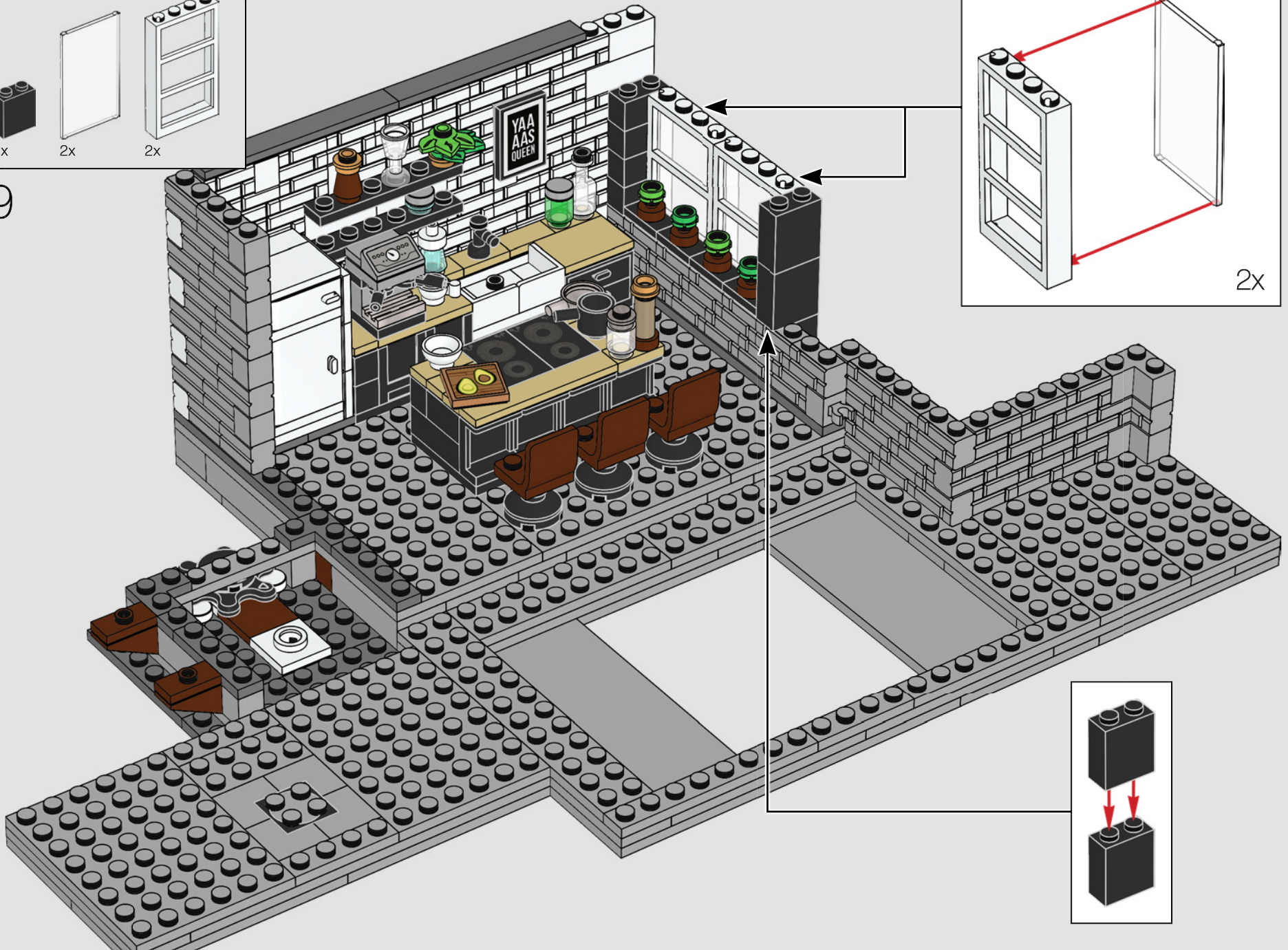

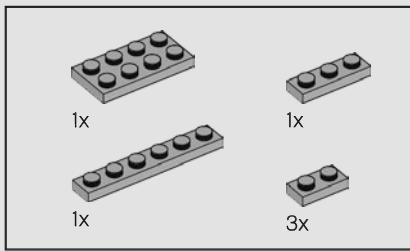

80

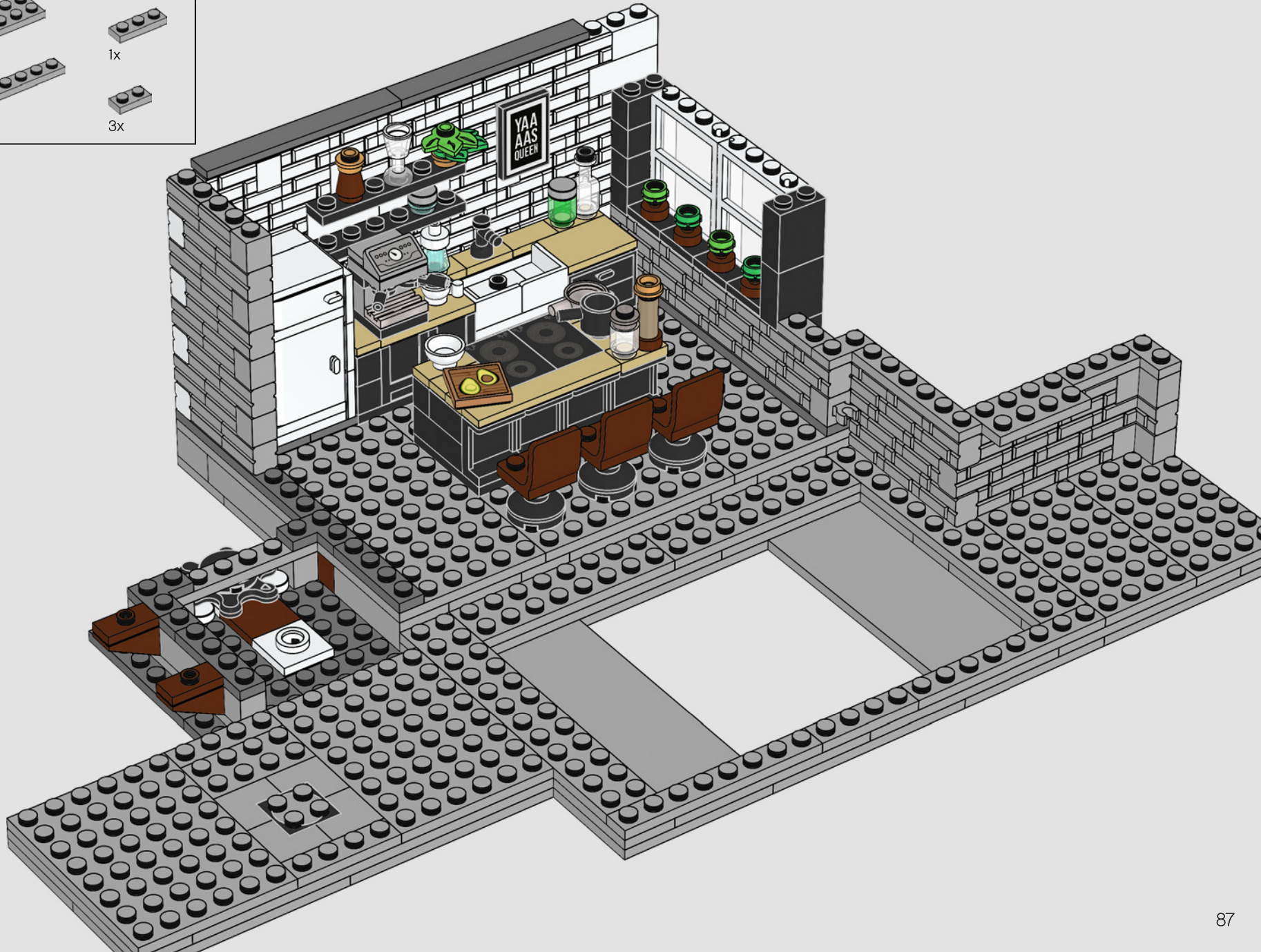

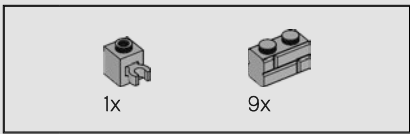

81



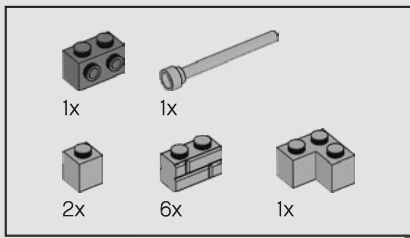

82

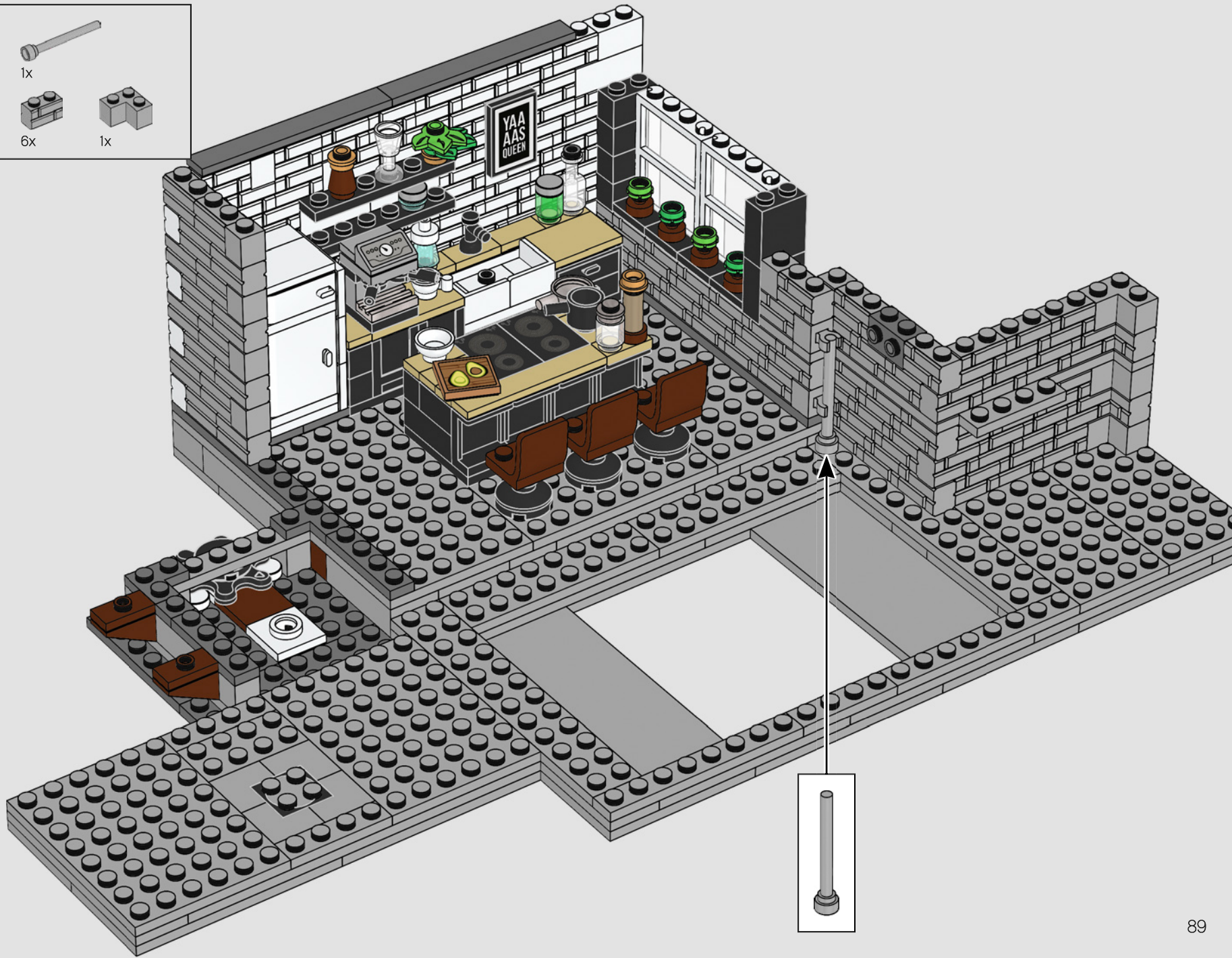

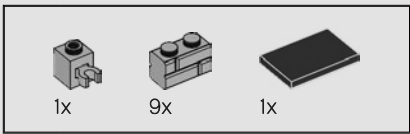

83

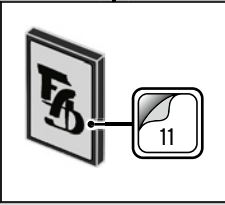
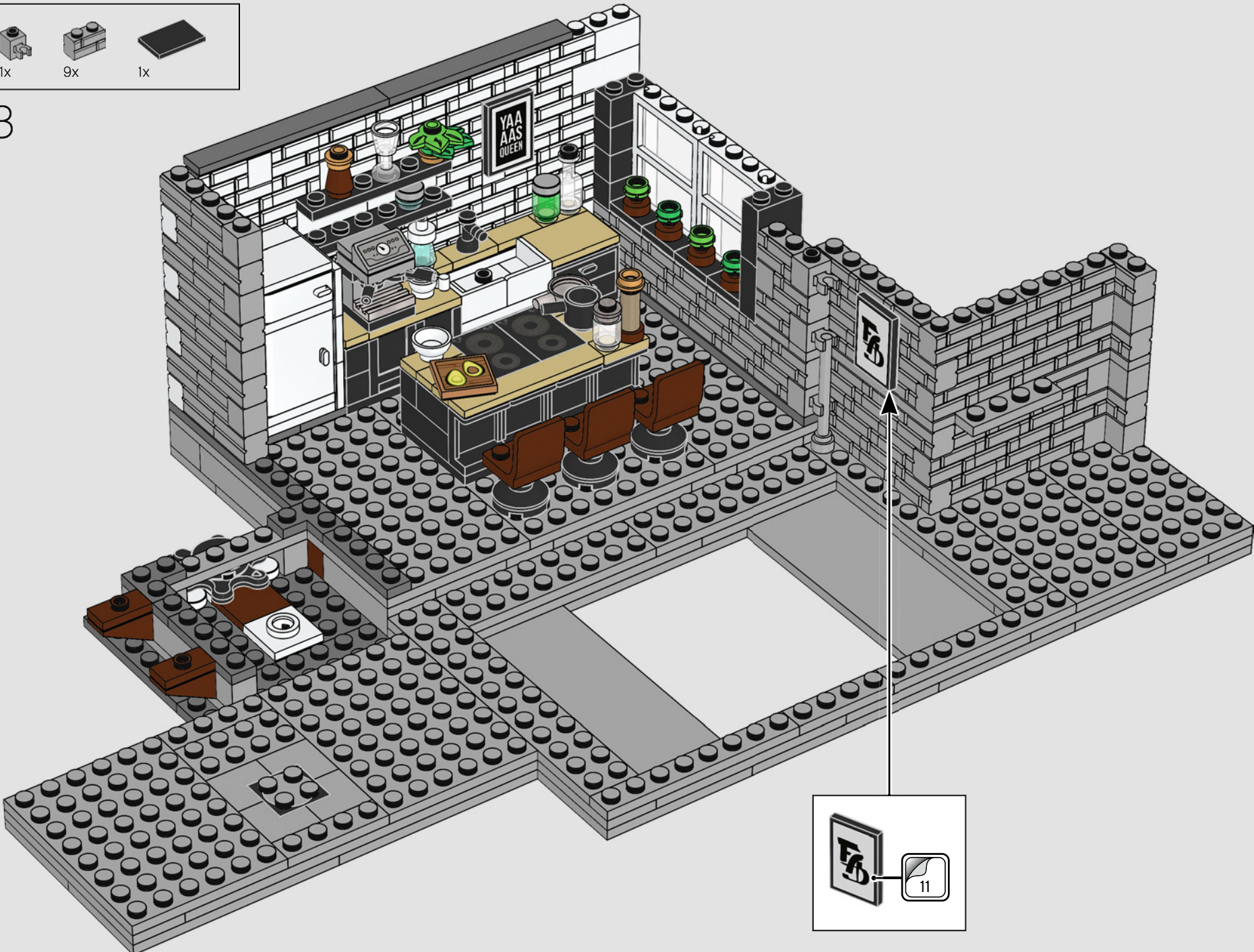

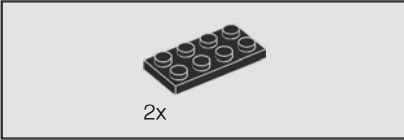
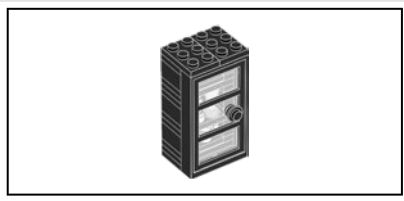

2x

84

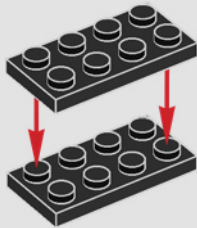

1x

2x

85

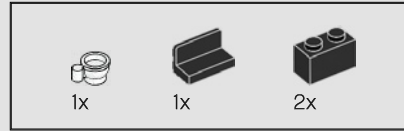
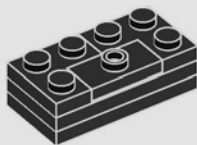

1x

1x

2x

86

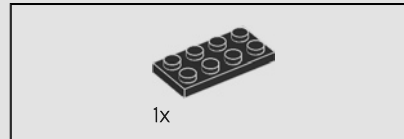
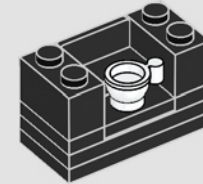

1x

87

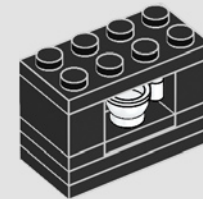



88

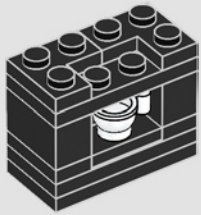

89



90

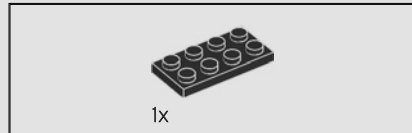

91



92

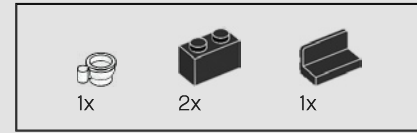
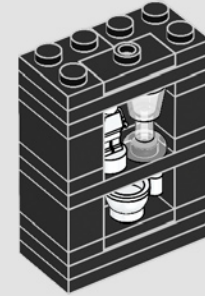

93



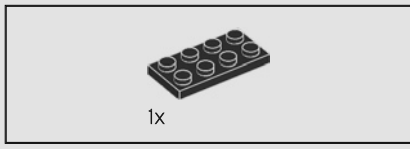

94

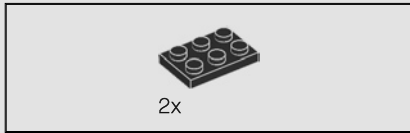

95

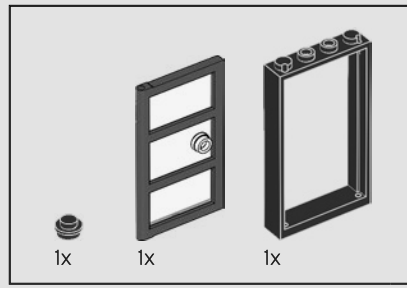
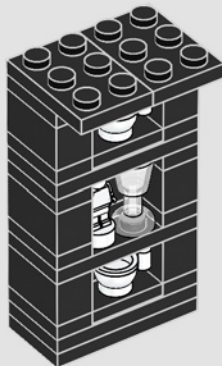

96

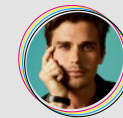
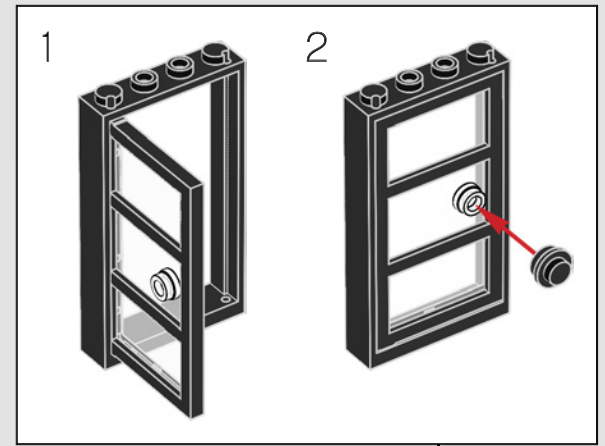
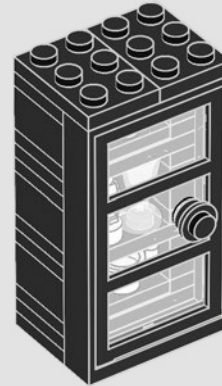

Antoni Porowski

"Growing up, LEGO® was my very favourite toy. I would build cities, pirate ships, destroy them, then start all over again. It's pretty incredible to think that young kids will now have LGBTQ+ options to play and build with. I'm honoured to be a part of this special partnership. Ten-year-old Antoni is internally screaming."

97

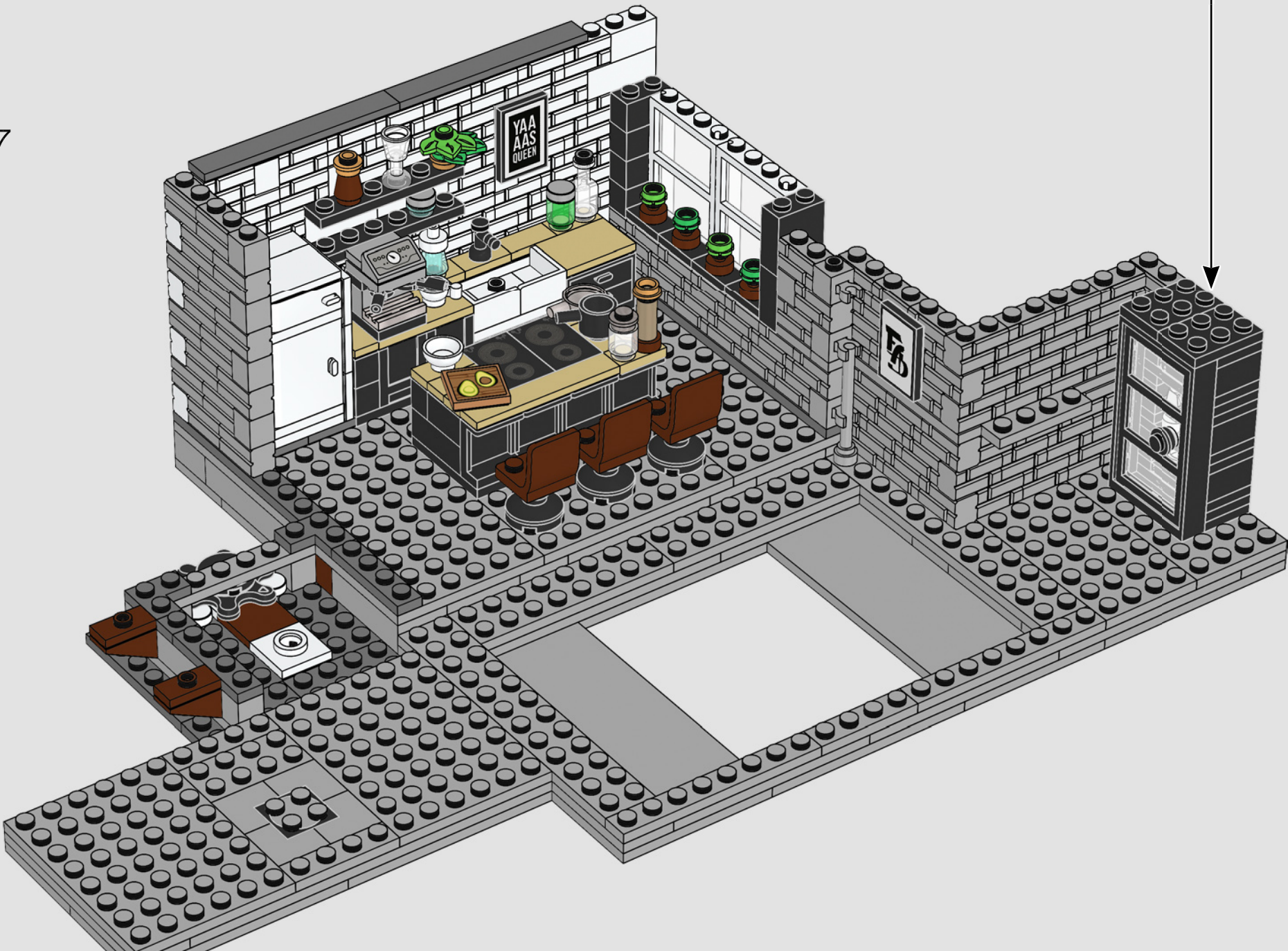

94

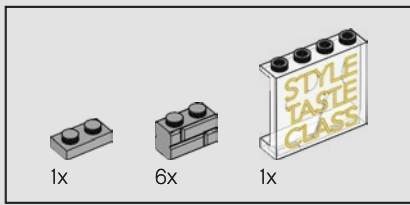

98

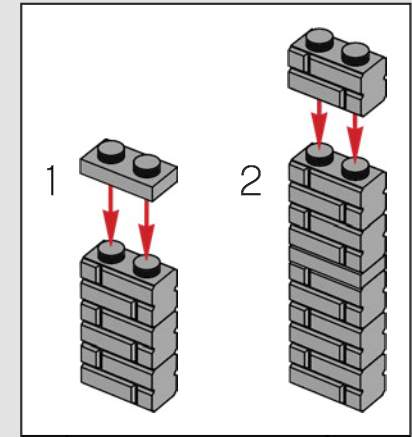
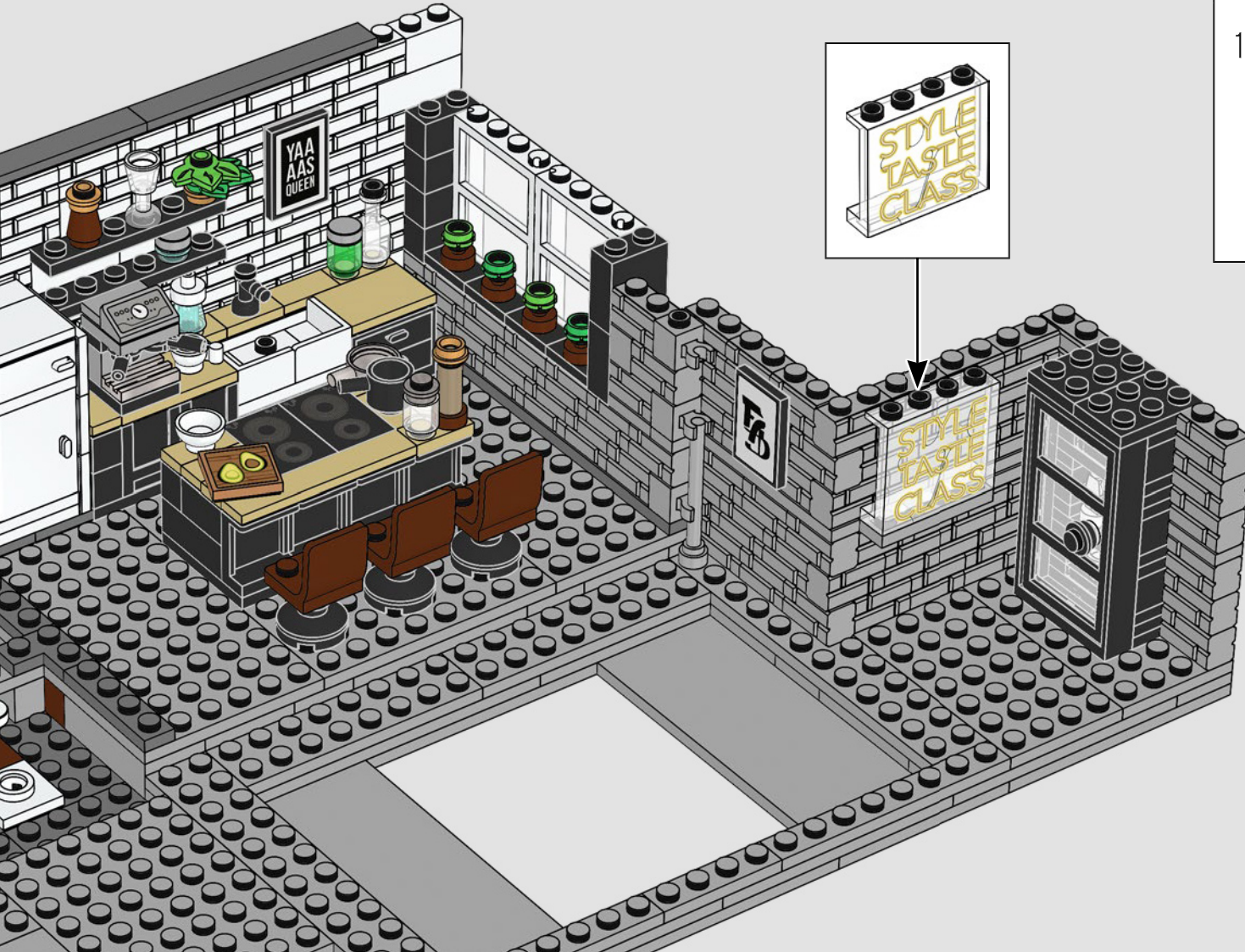

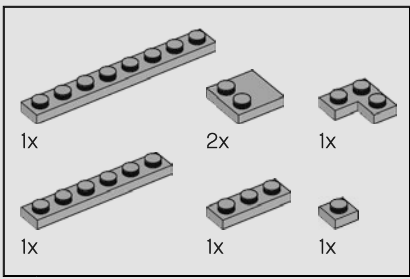

99



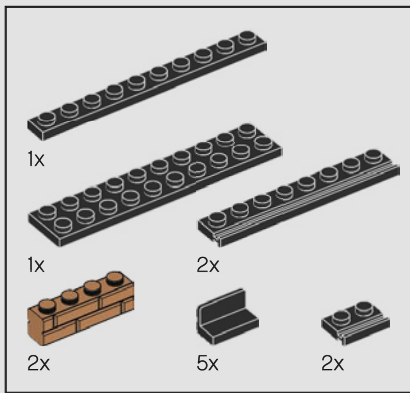

Tan France

"We, the Fab Five, are all big kids at heart, and what we do on *Queer Eye* sometimes feels so much more like play than work. It seems such a natural fit for us to collaborate on this LEGO® set, such a well-loved toy for kids of all ages!"

100

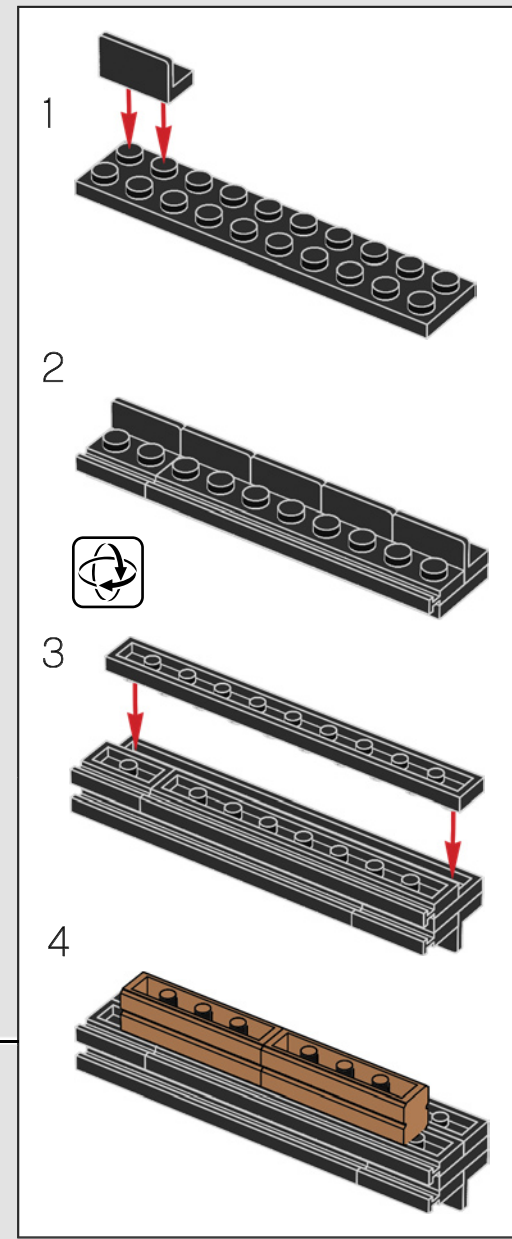



101



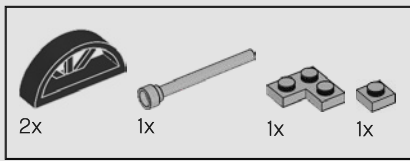

102

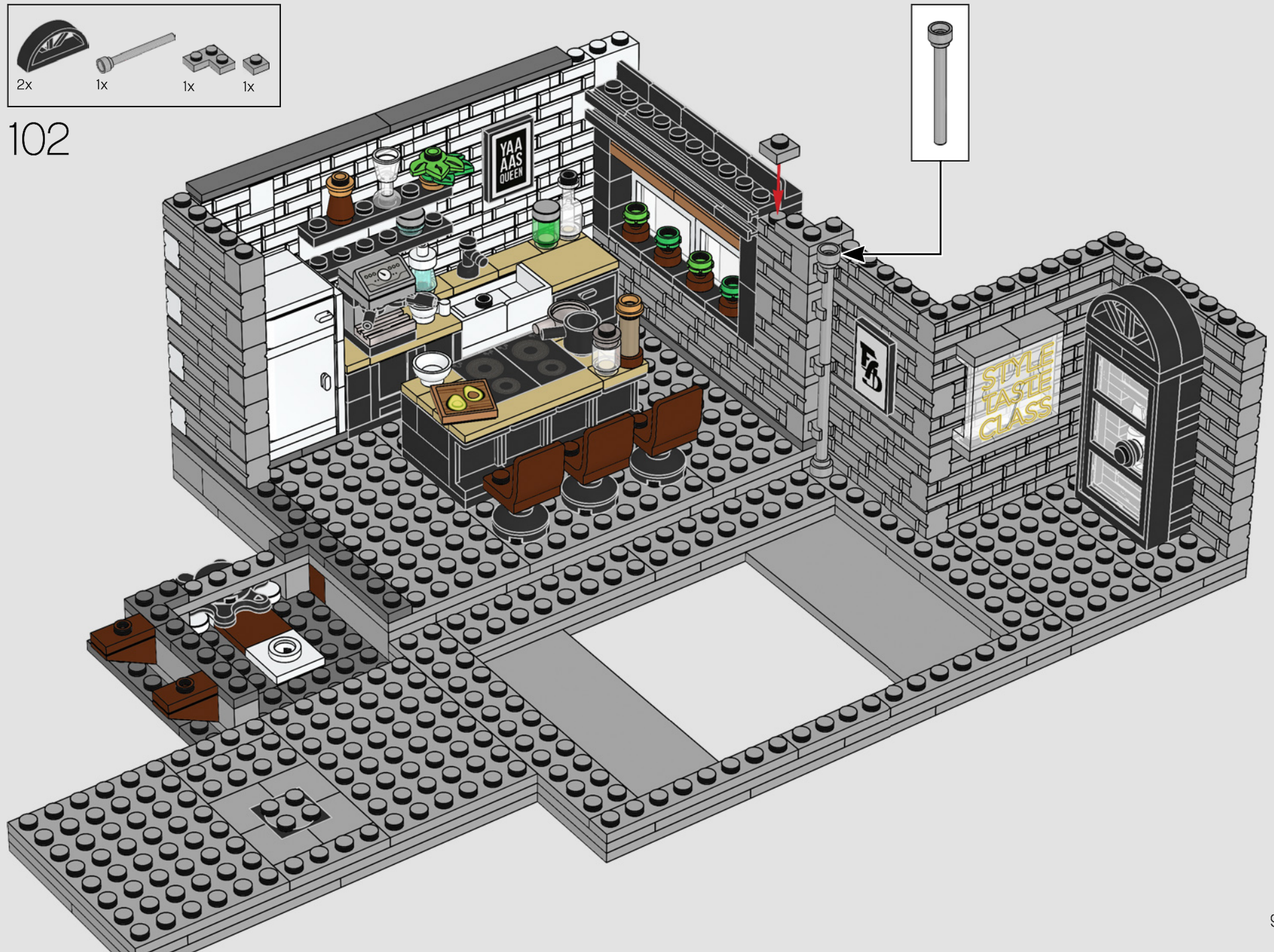



7x

103

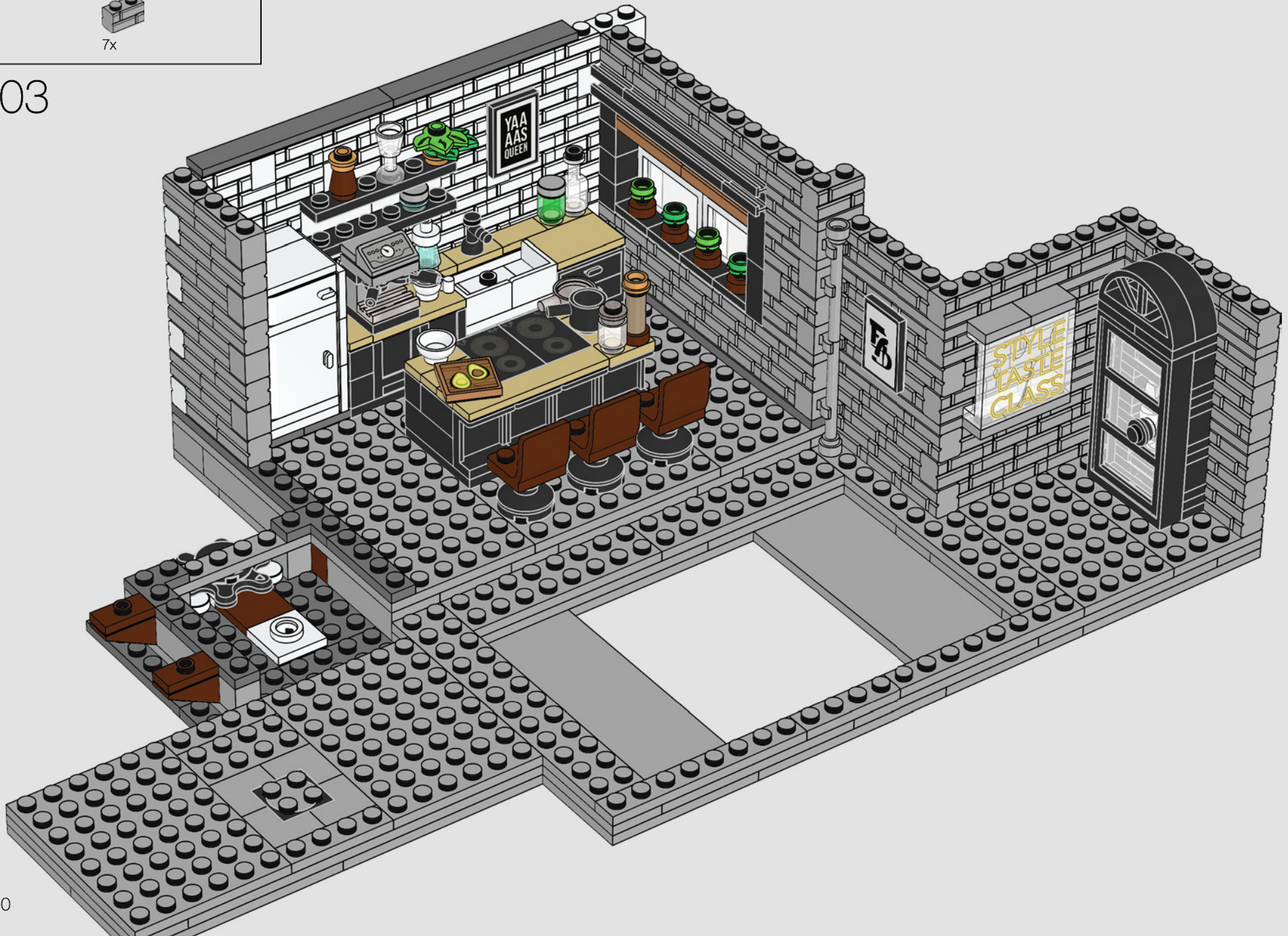

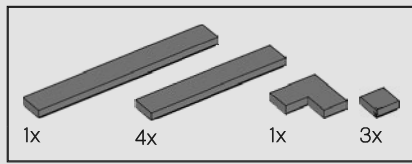

104



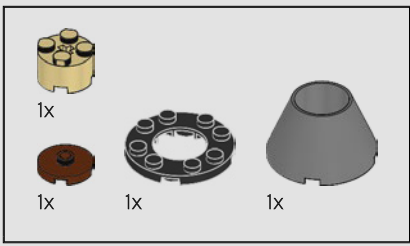

105

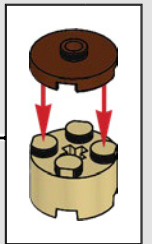
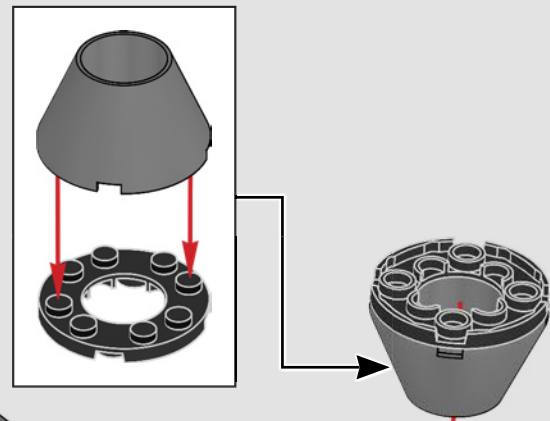

102

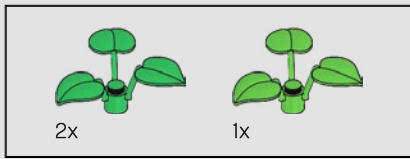

106

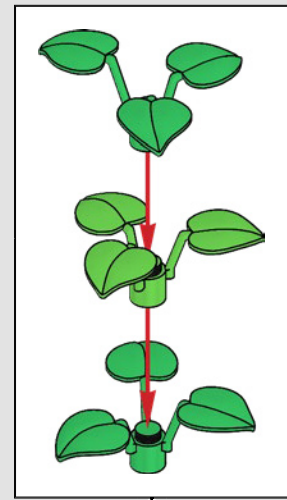
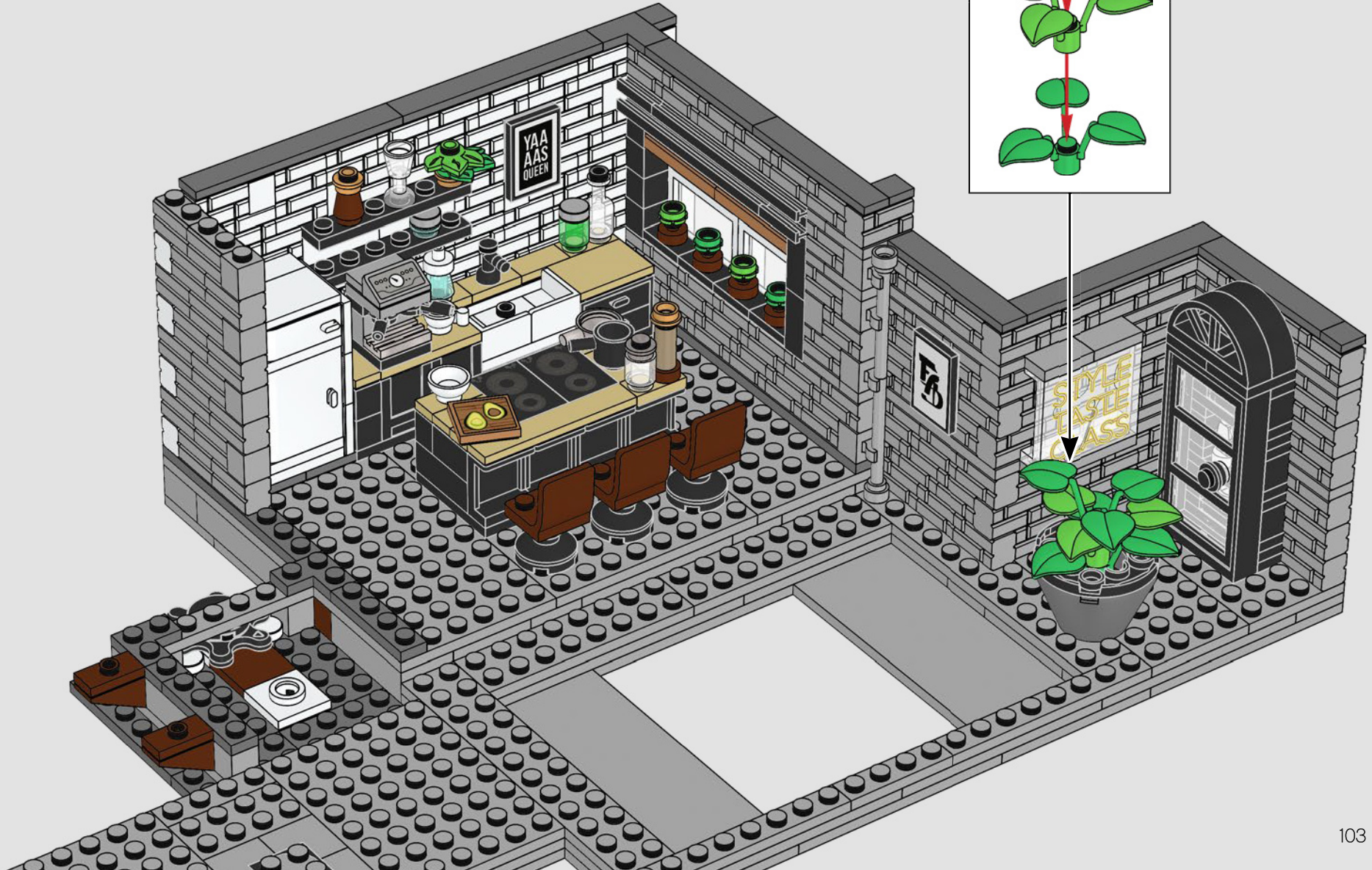

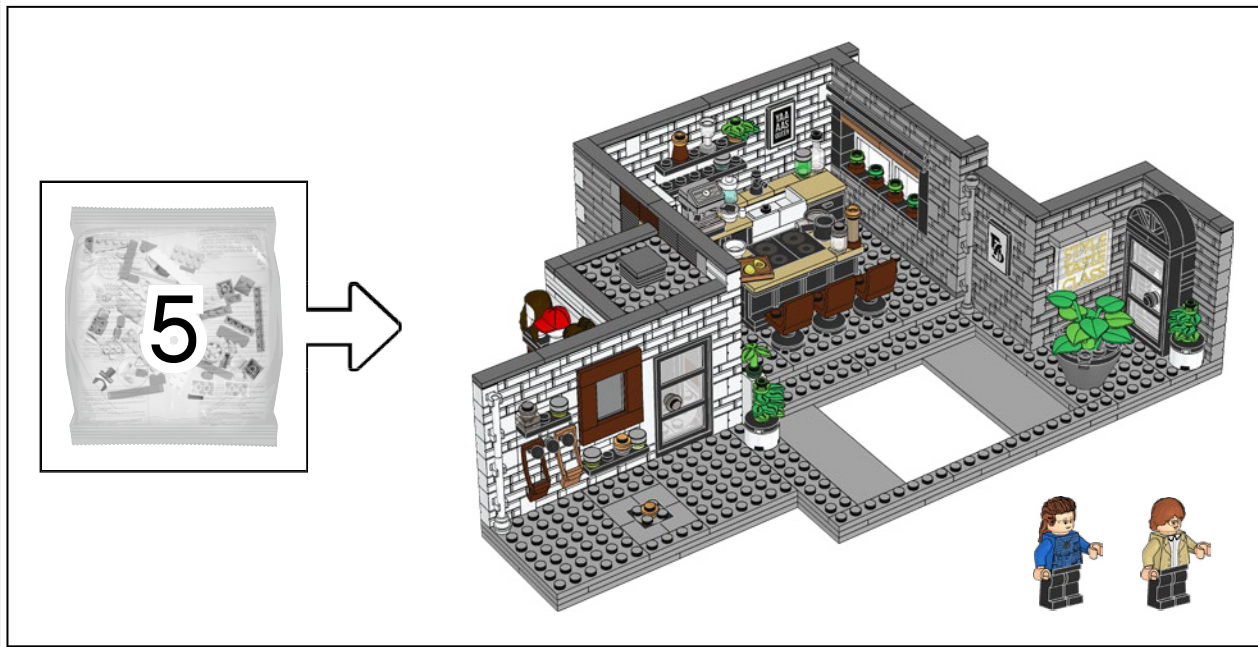

Jonathan Van Ness

"So happy this set comes with Kathi Dooley! She is my childhood hero and means so much to me. Plus, I get to play cutting off her mullet as many times as I want now."



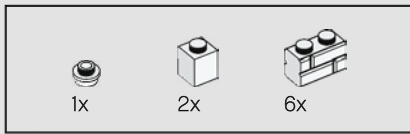

107



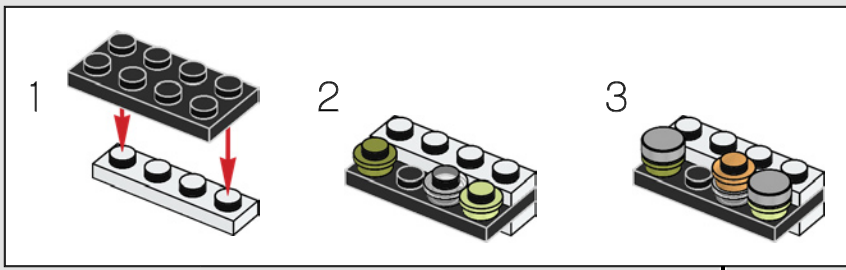
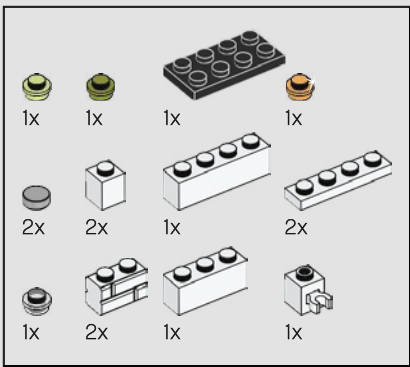

108



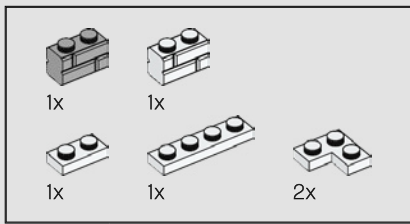

109



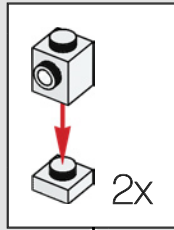
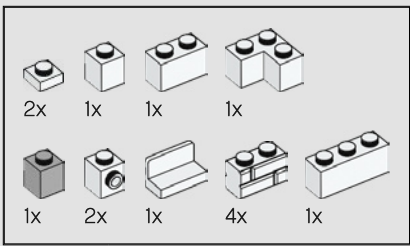

110



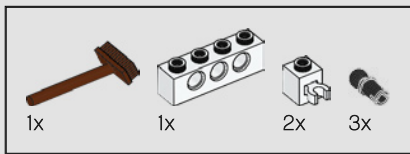

111

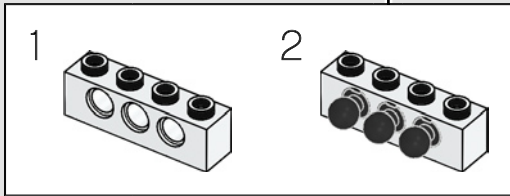
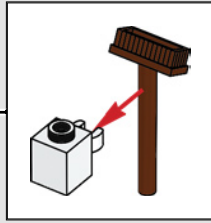

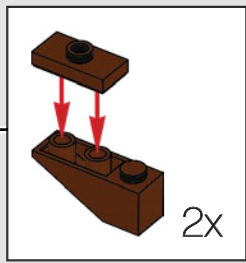
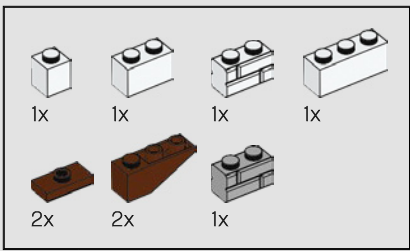

112



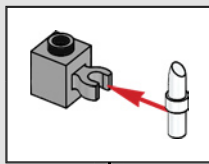
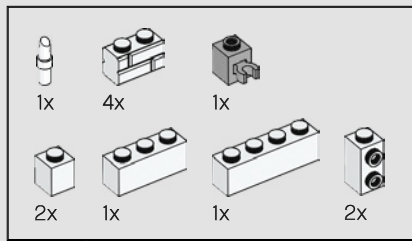

113



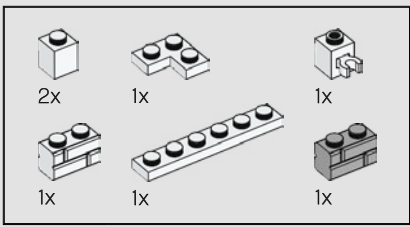

114



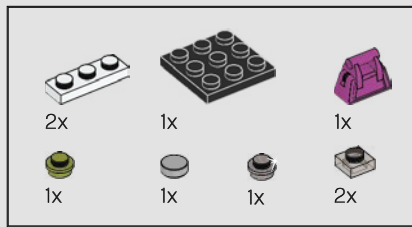

115

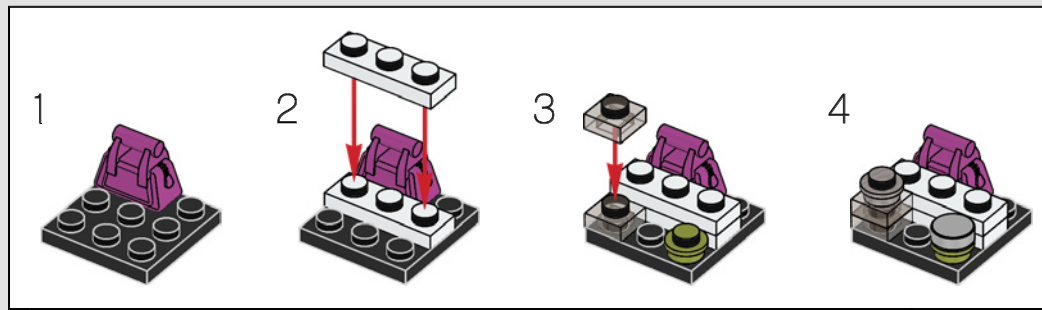

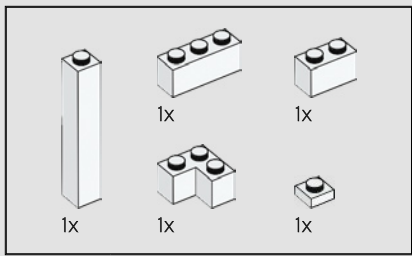

116



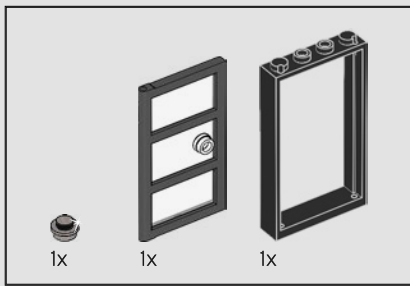

117

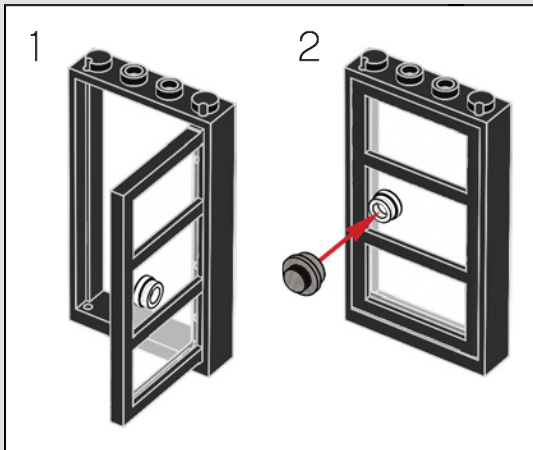

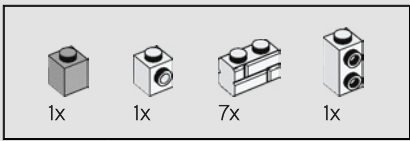

118



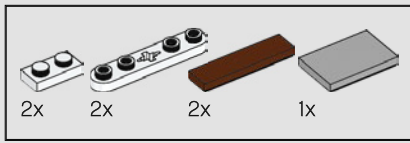

119

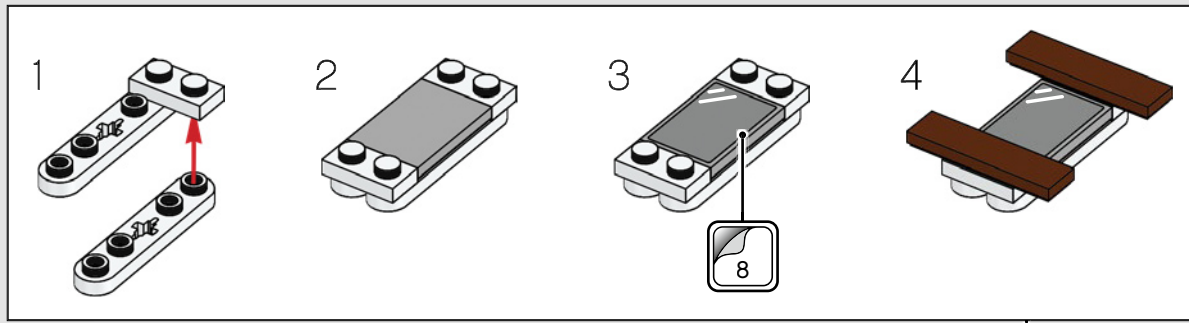

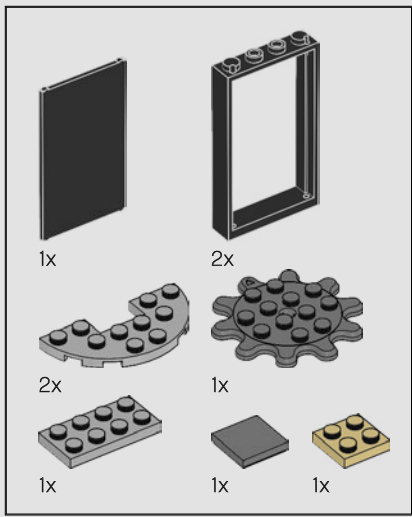

120

1

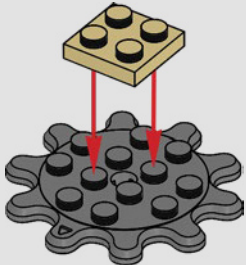

2

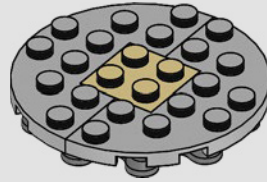

3

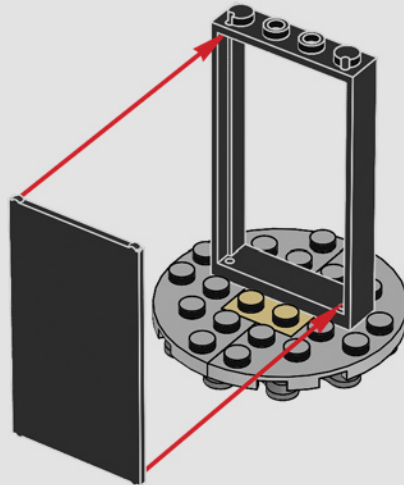

4

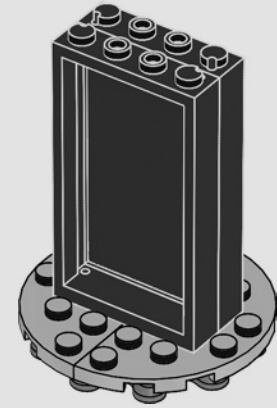

5

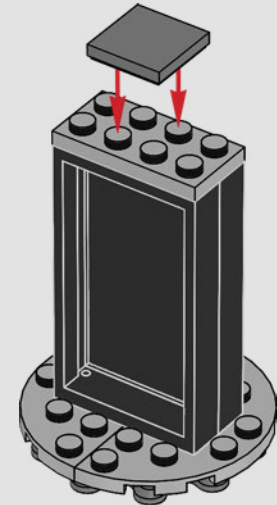

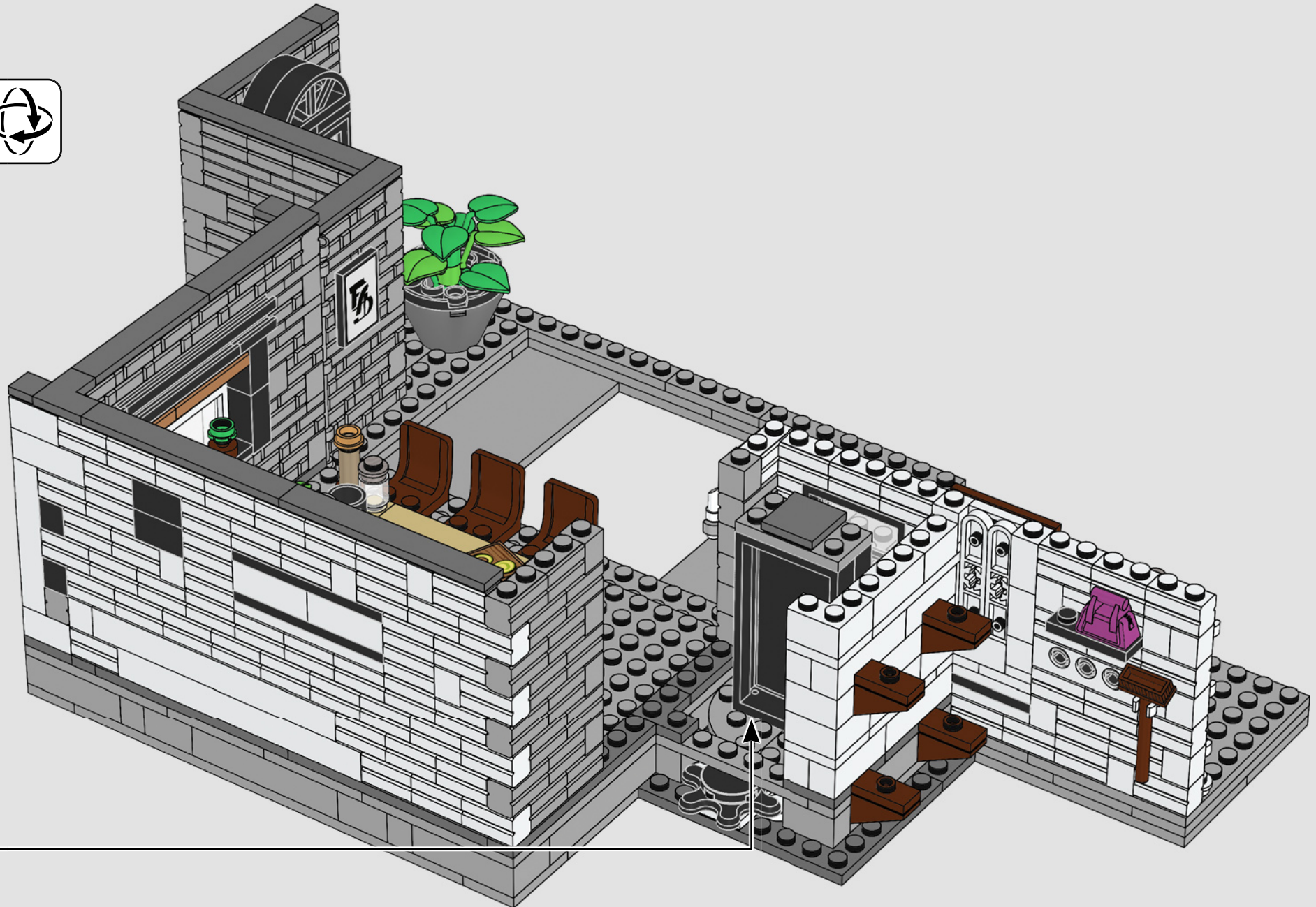

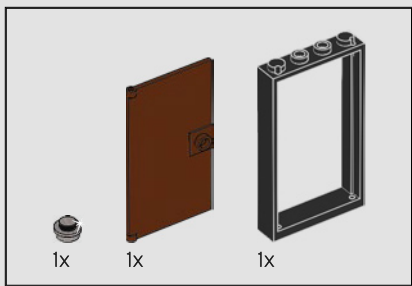

121

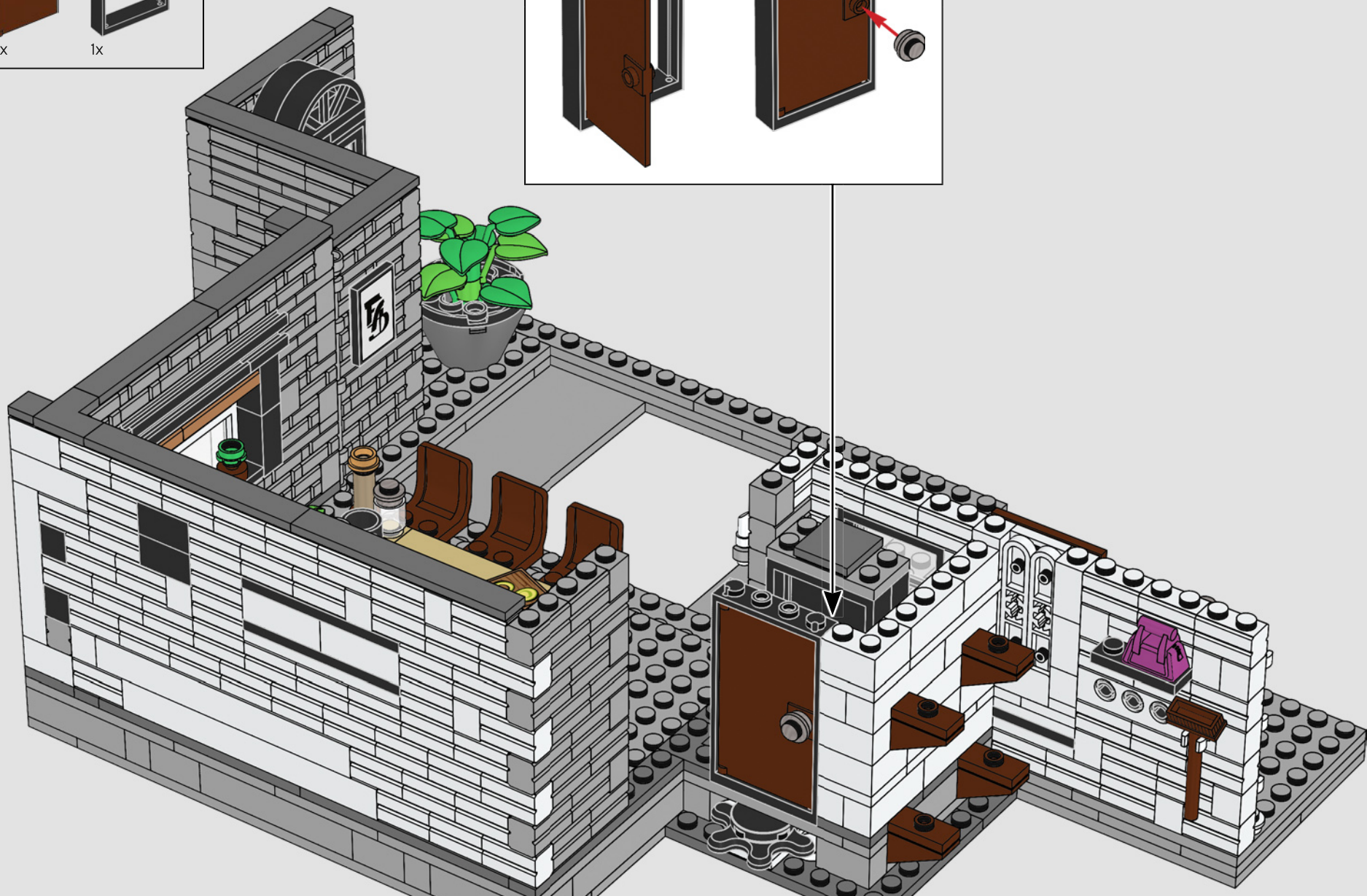
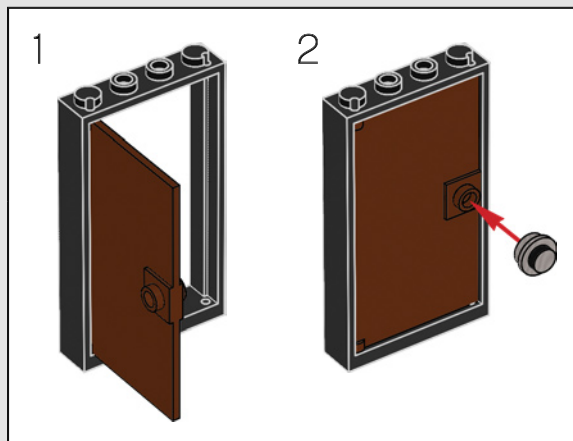

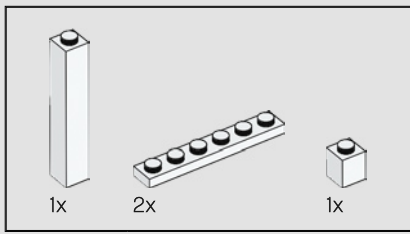

122

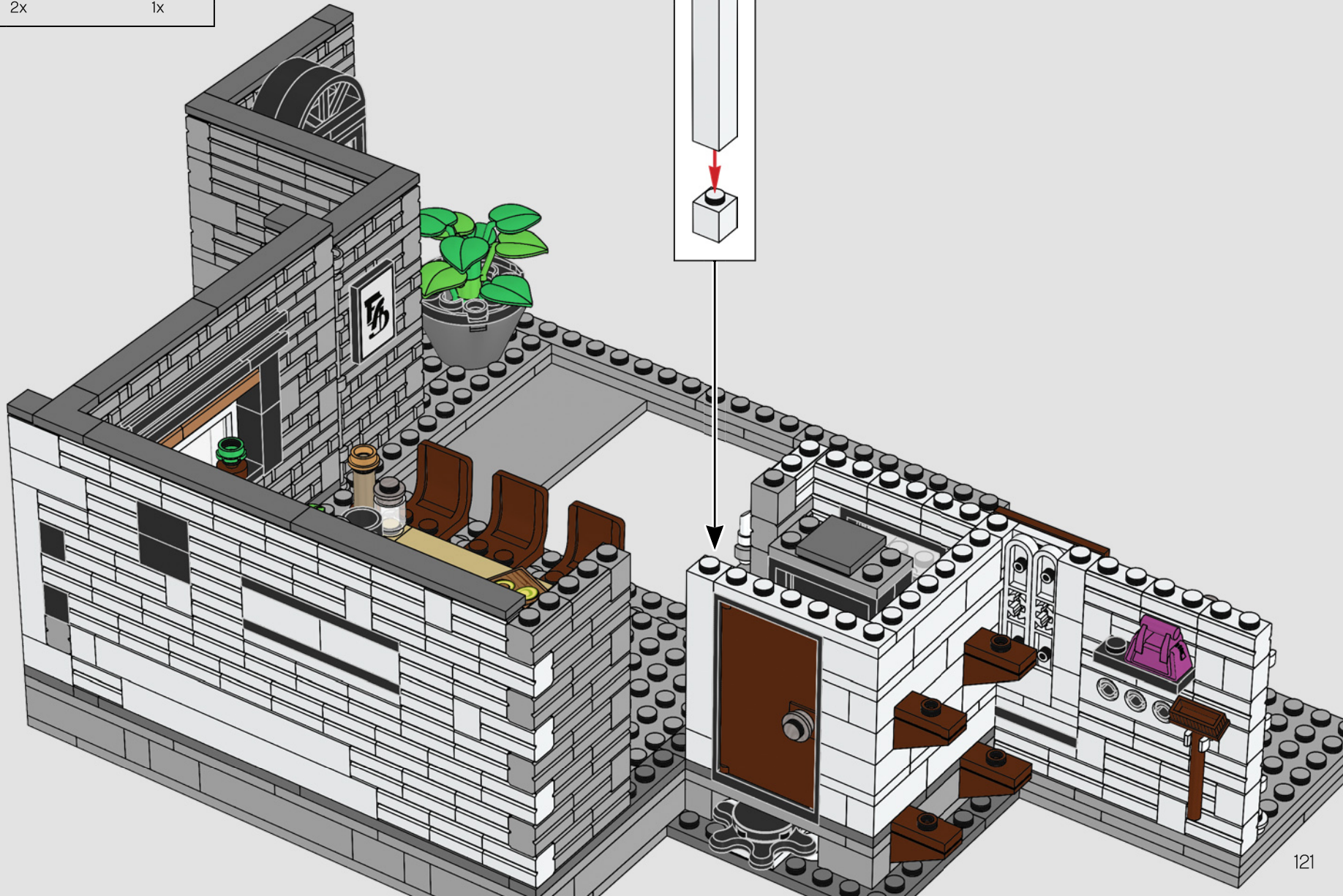

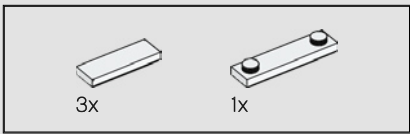

123



Tan France

*"I love being a part of the Fab 5, and through *Queer Eye*, I get to shed light on the beauty of the diversity of our community. That was my main hope, when I auditioned for the show, and I'm so grateful to be in this position."*

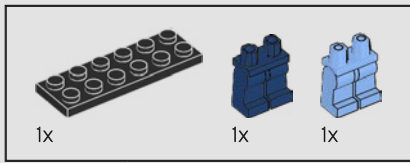

124

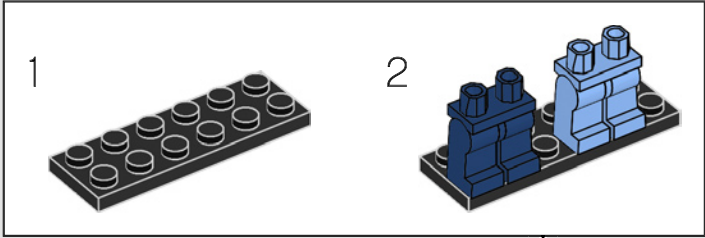
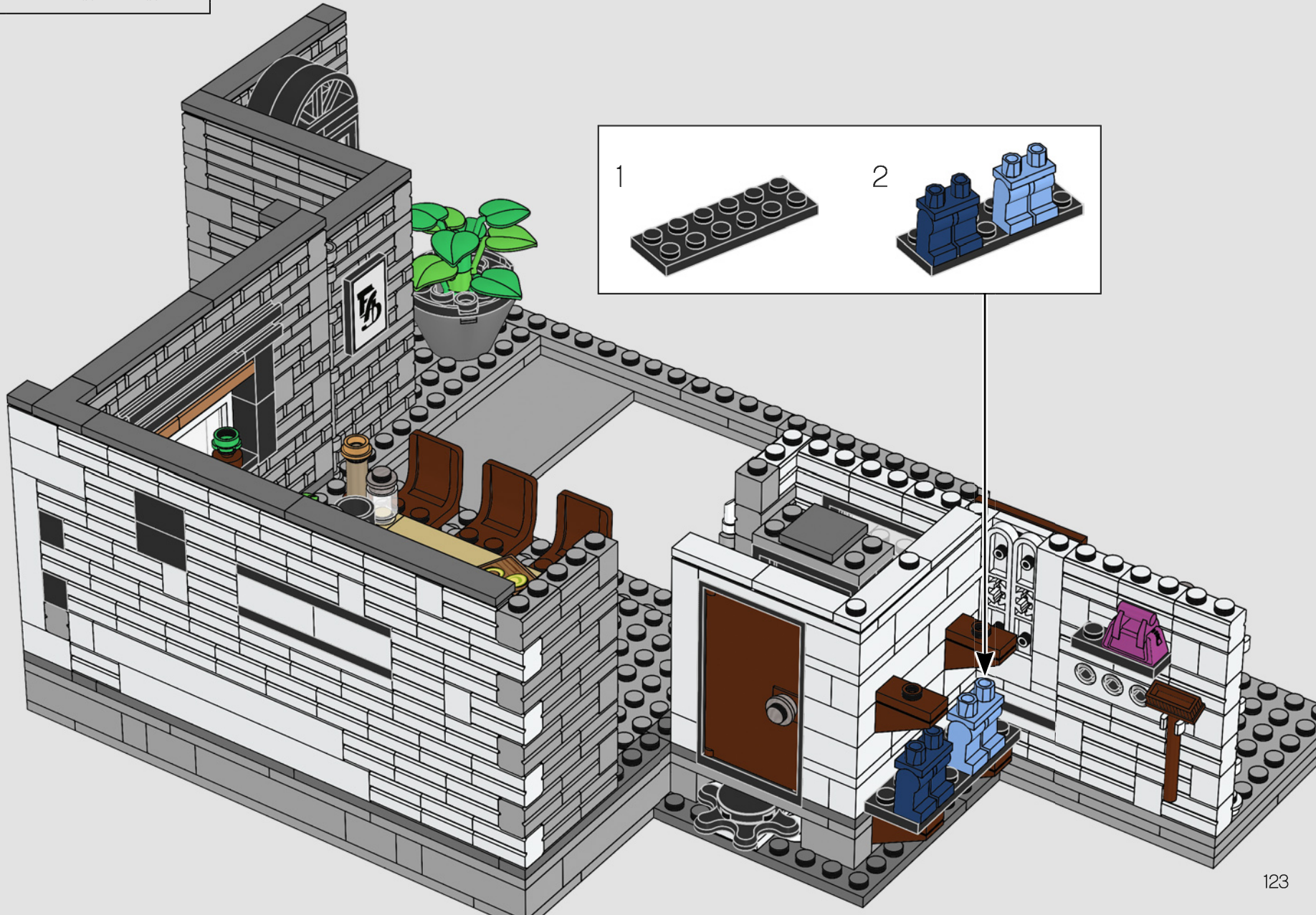

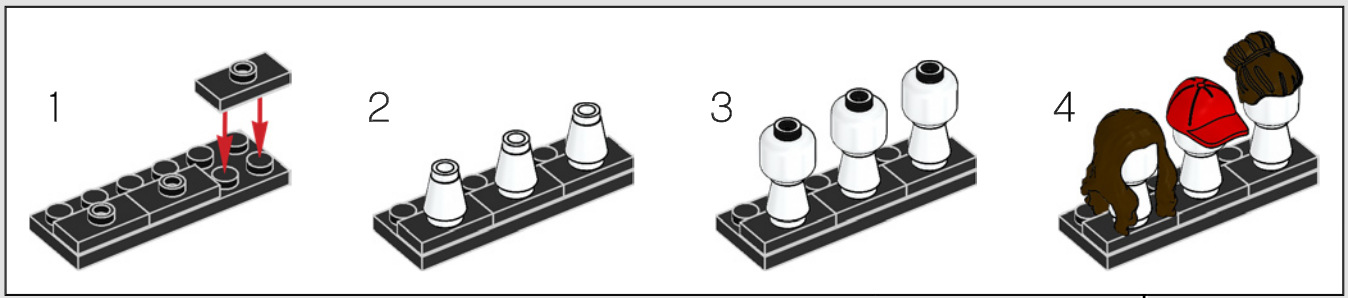
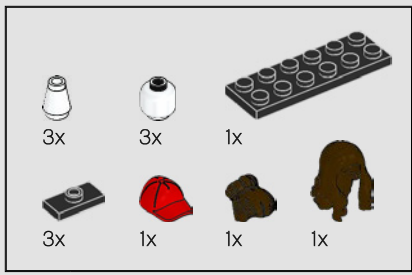

125



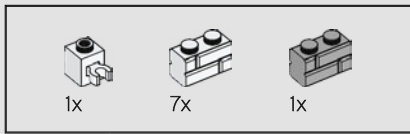

126



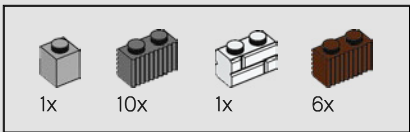

127

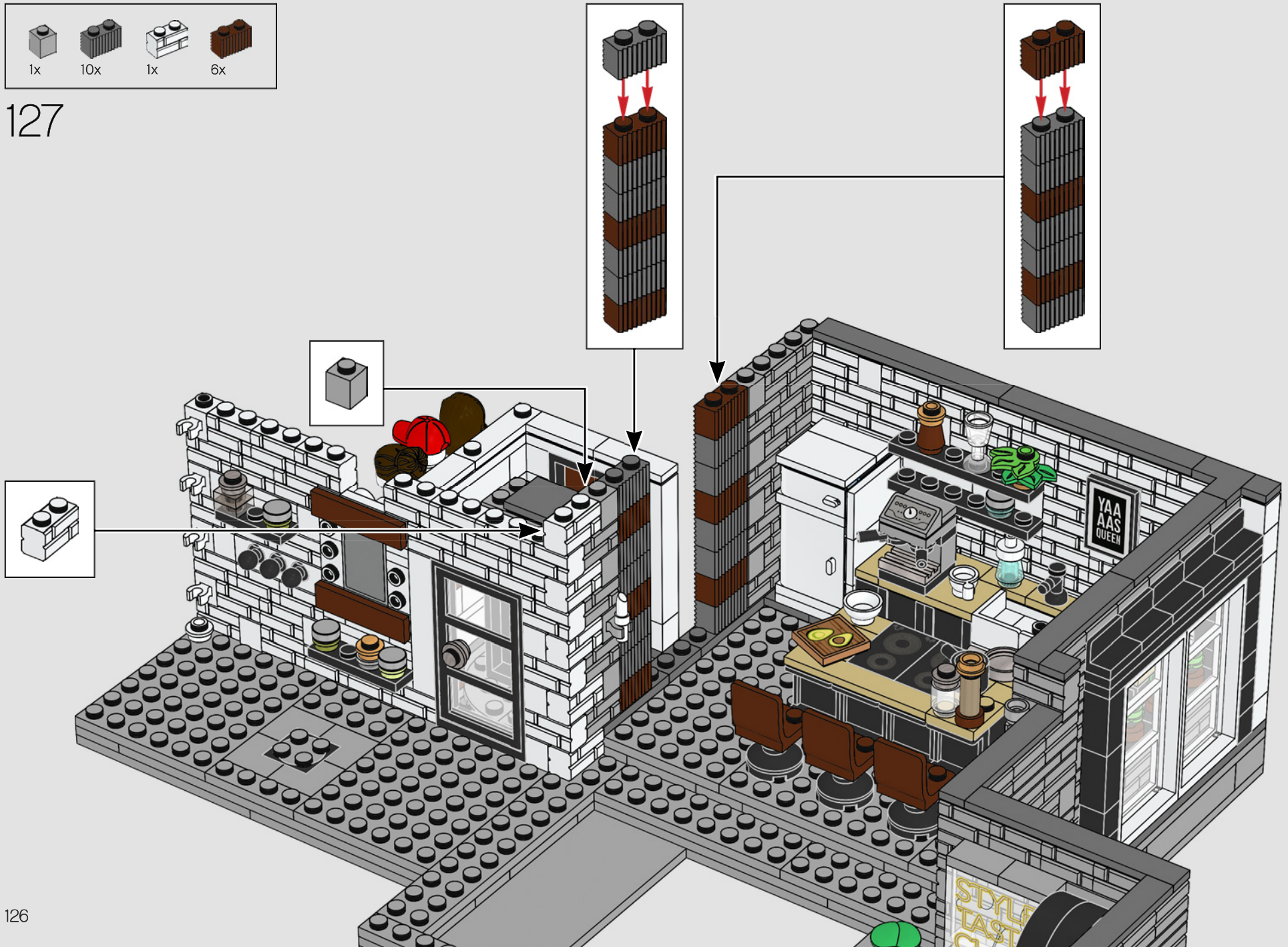

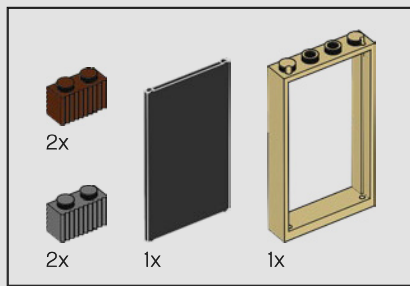

128

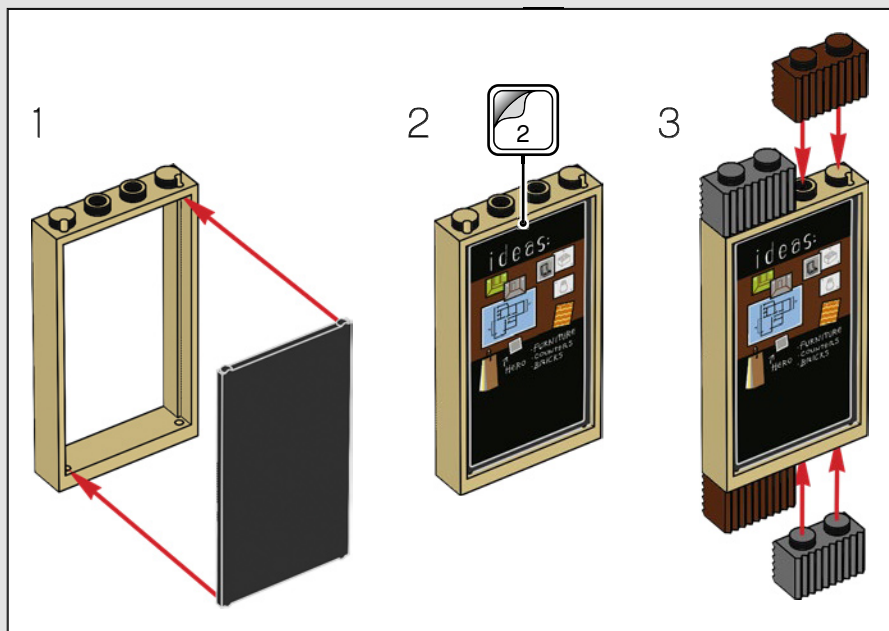

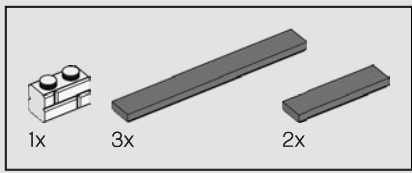

129

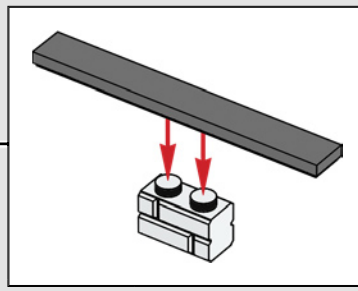

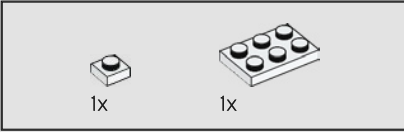
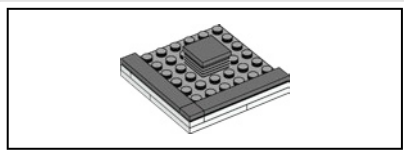

130

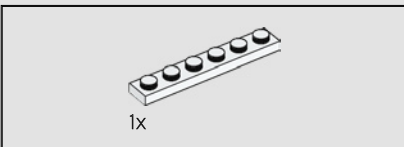
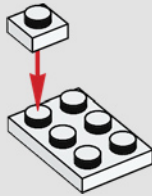

131

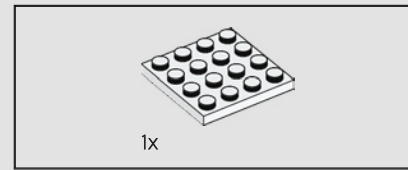
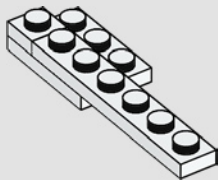

132

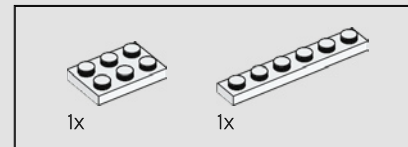
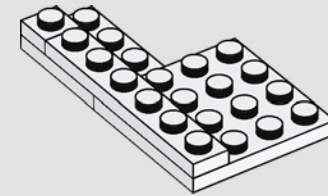

133

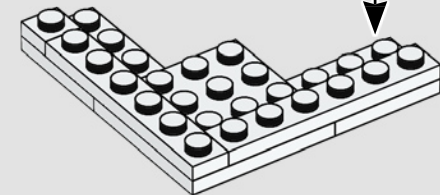
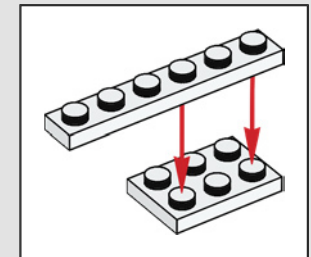

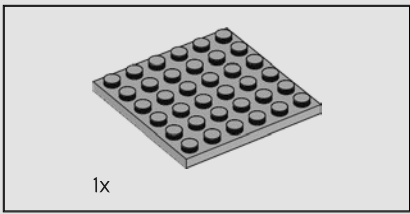

1x

134

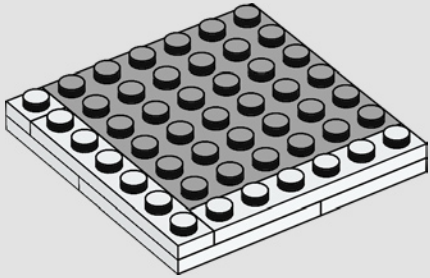

1x

1x

135

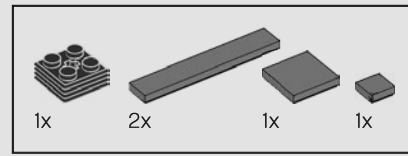
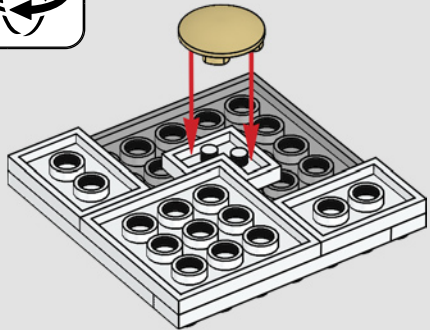

1x

2x

1x

1x

136

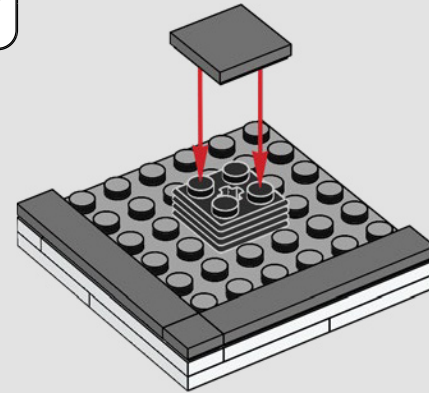
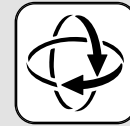

Tan France

"That transformation chamber is genius! One twist and 'Ta-daaa!' the big reveal!"

137



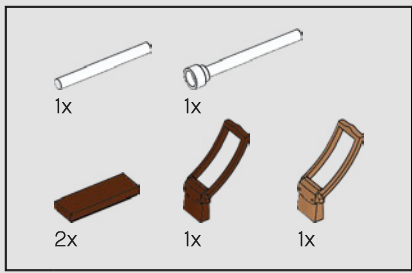

138



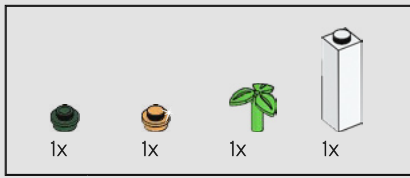

139

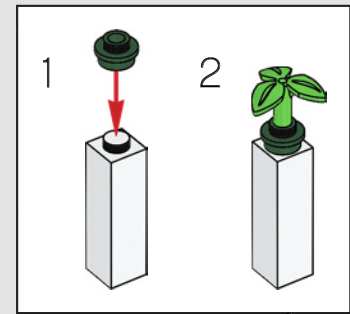



140



Karamo Brown

"As an adult, any creative process can help give you focus and take you out of your own head space. Building with LEGO® is a perfect way to help you unwind and de-stress while also giving you a real sense of accomplishment with whatever you create. So just like our show, LEGO can help in a little way to piece together people's lives. This is the perfect partnership."

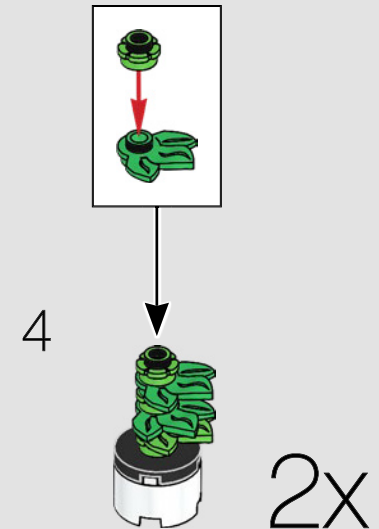
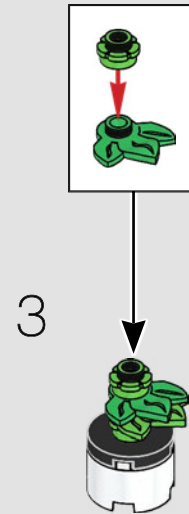
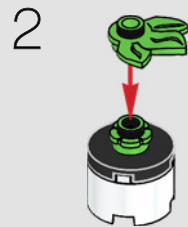
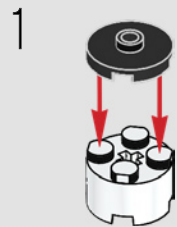





Bobby Berk

"I'm so happy with the finished set. I think we have really managed to capture the essence of everything in our original loft!"





FEEDBACK AND WIN



FEEDBACK AND WIN

Your feedback will help shape the future development of this product series.

Please visit:

FEEDBACK UND GEWINNEN

Dein Feedback trägt zur Weiterentwicklung dieser Produktreihe bei.

Geh auf:

COMMENTEZ ET GAGNEZ

Vos commentaires nous aideront à concevoir les futurs produits de cette gamme.

Rendez-vous sur :

COMENTA Y GANA

Tu opinión nos ayudará a dar forma al desarrollo de esta serie de productos en el futuro.

Visita:

反馈有奖

您的反馈将有助于我们在今后改进本系列产品。

请访问：

[LEGO.com/productfeedback](https://www.lego.com/productfeedback)

By completing, you will automatically enter a drawing to win a LEGO® set.

Terms & Conditions apply.

Durch Ausfüllen nimmst du automatisch an der Verlosung eines LEGO® Preises teil.

Es gelten die Teilnahmebedingungen.

En envoyant vos commentaires, vous serez automatiquement inscrit(e) à un tirage au sort qui vous permettra de remporter un prix LEGO®.

Offre soumise à conditions.

Al contestar, participarás automáticamente en el sorteo y podrás ganar un set LEGO®.

Sujeto a Términos y Condiciones.

完成我们的反馈调查，即可自动进入抽奖环节，赢取乐高®套装。

适用《条款和条件》。

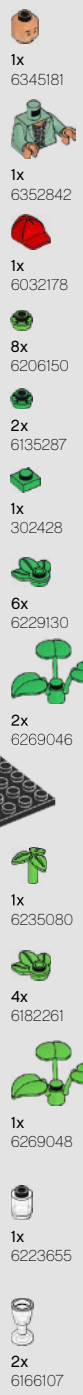



Customer Service
 Kundenservice
 Service Consommateurs
 Servicio Al Consumidor
 LEGO.com/service or dial



