



NINJAGO



DRAGONS RISING

71789





 **FR**
DONNEZ
OU
RECYCLEZ

 OU  OU 
ASSOCIATION MAGASIN DÉCHÈTERIE

Adresses sur quefairedemesdechets.fr



LEGO.com/sustainable-packaging



BUILDER



Apple and the Apple logo are trademarks of Apple Inc., registered in the U.S. and other countries and regions. App Store is a service mark of Apple Inc. Google Play and the Google Play logo are trademarks of Google LLC. Tencent and the Tencent logo are trademarks of Tencent Inc.

🔍 LEGO.com/devicecheck

EN Ask parents' permission before going online | **DE** Eltern um Erlaubnis bitten, bevor du online gehst | **FR** Demande l'autorisation d'un parent avant d'aller en ligne | **IT** Chiedi il permesso ai tuoi genitori prima di andare online | **ES** Pídeles permiso a tus papás antes de conectarte a Internet | **PT** Peça autorização aos pais antes de acederes online | **ZH** 上网前应先征得父母的同意 | **PL** Poproś rodziców o zgodę, zanim wejdiesz do Internetu | **CS** Než půjdeš na internet, požádej rodiče o svolení | **SK** Skôr než pôjdeš na internet, vypýtaj si povolenie od rodičov | **HU** Kérj szülői engedélyt, mielőtt online csatlakoznál! | **RO** Cere permisiunea părinților înainte de a te conecta online | **BG** Поискайте разрешение от родител, преди да влезете онлайн | **LV** Pirms došanās tiešsaistē palūdz atļauju vecākiem | **ET** Enne Interneti kasutamist küsi vanematelt luba | **LT** Prieš prisijungdami prie interneto, atsiklauskite tėvų





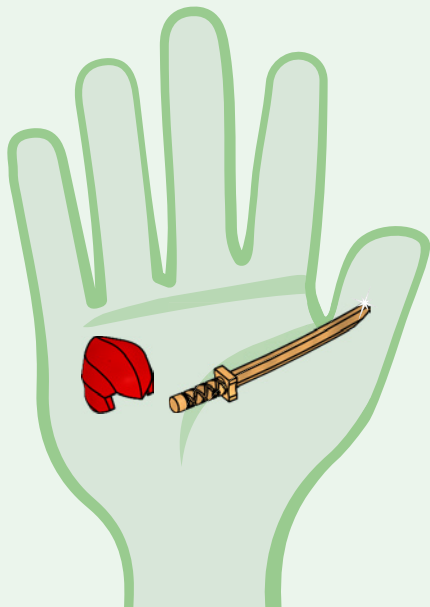
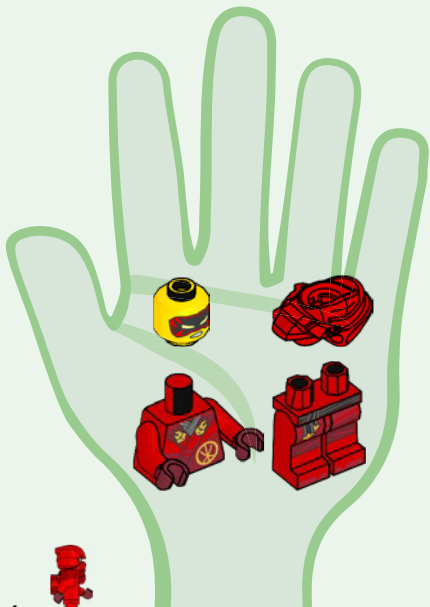



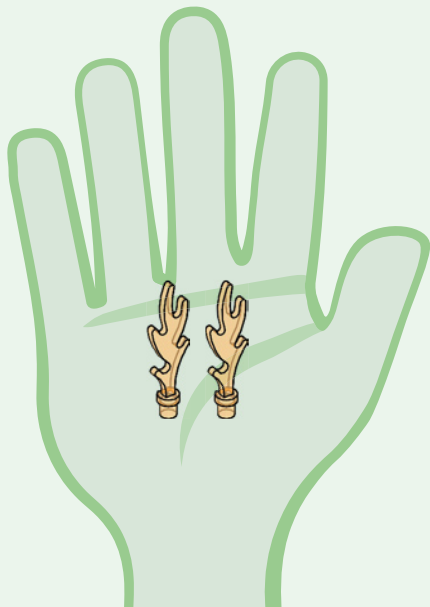
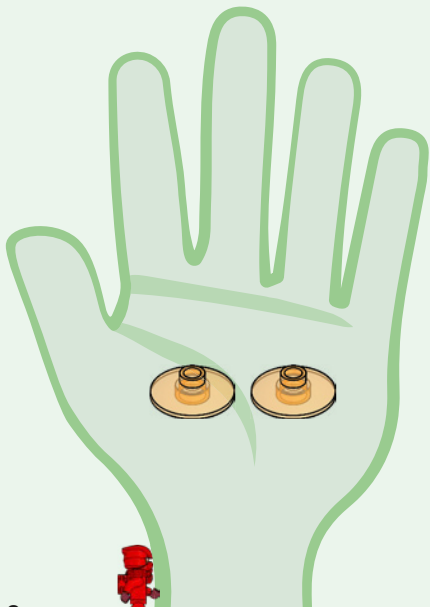

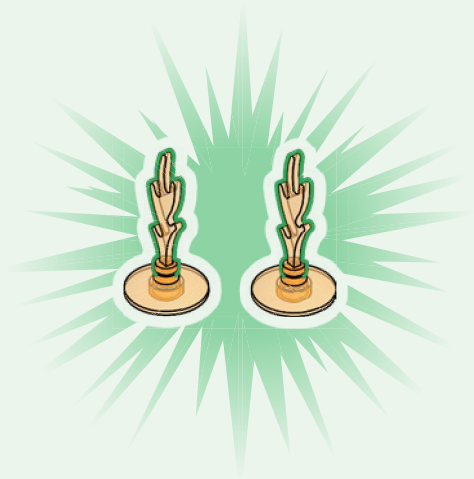

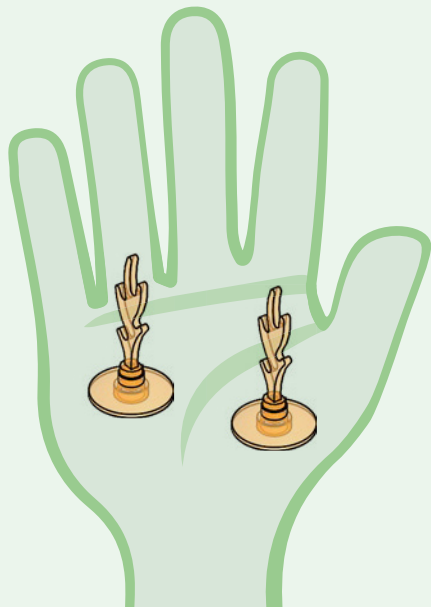



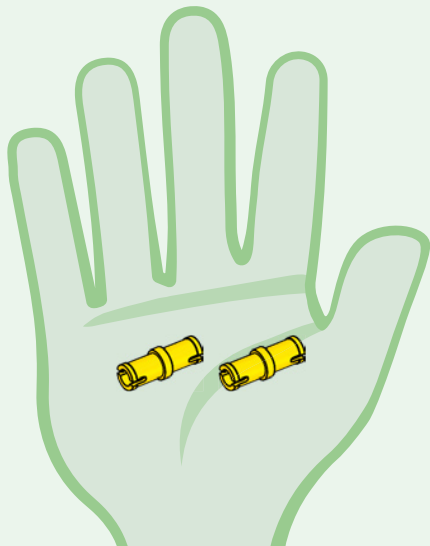
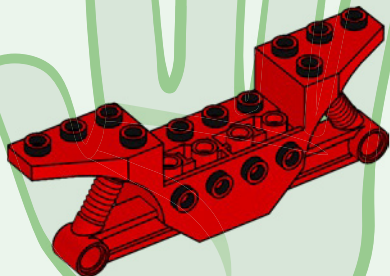

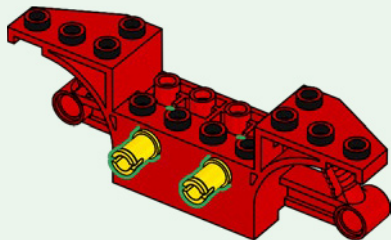
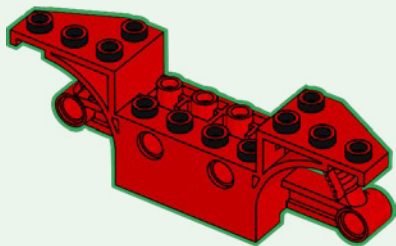

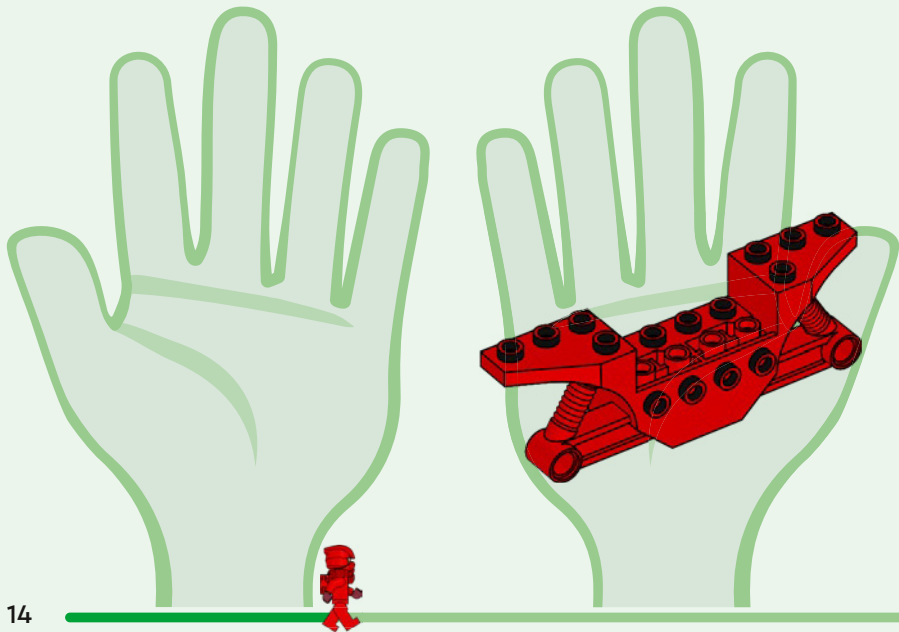

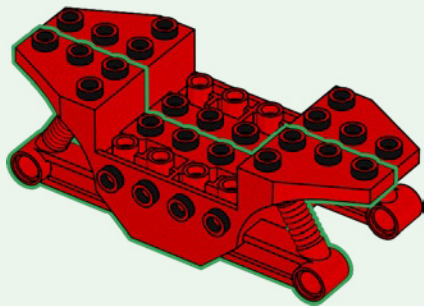

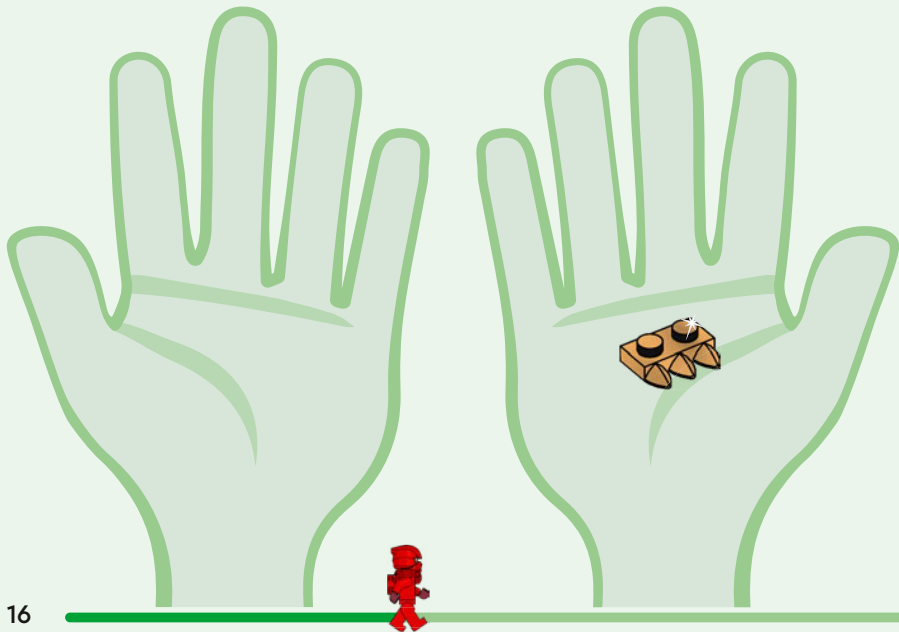

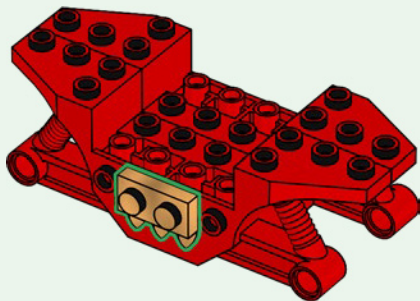

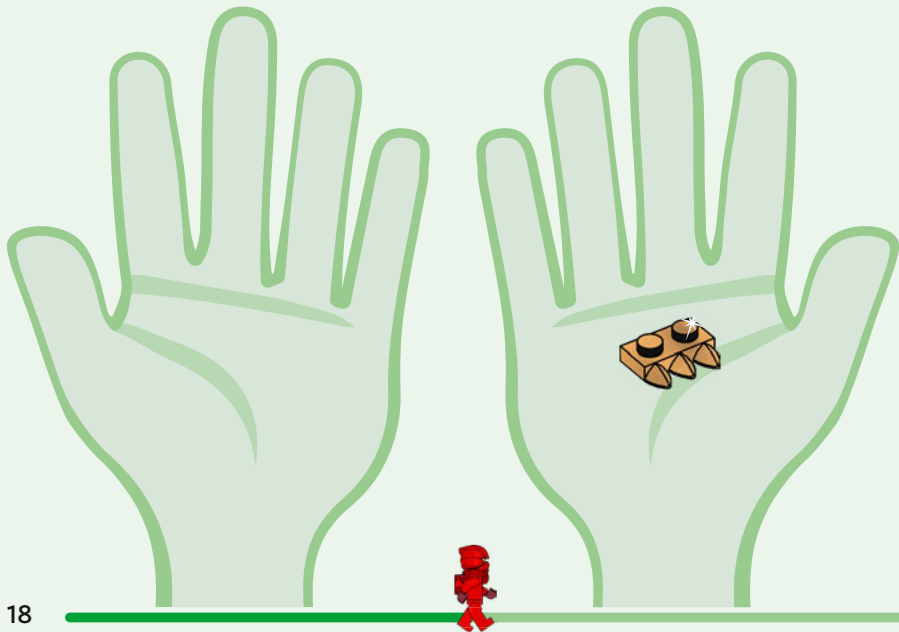

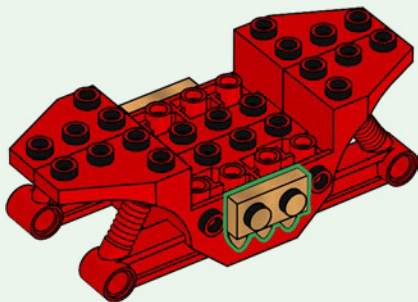

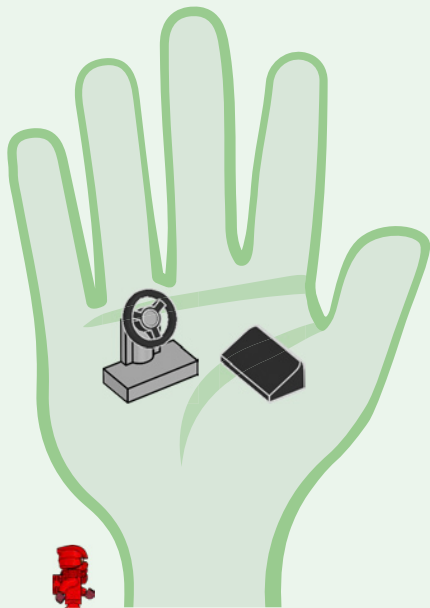

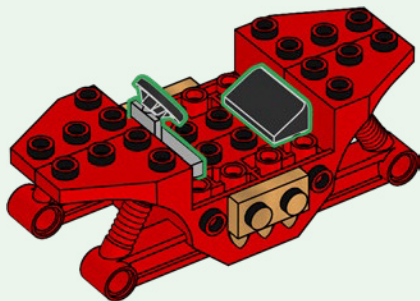

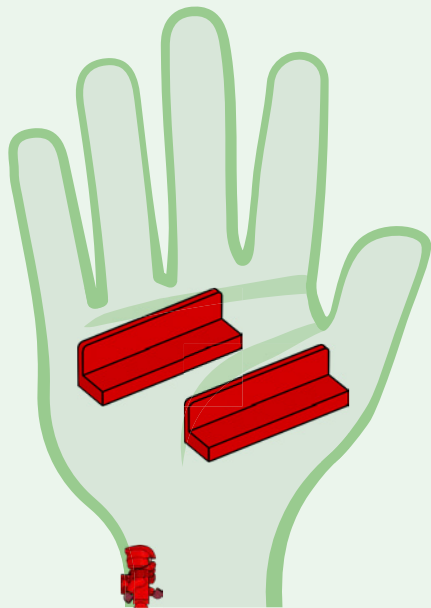

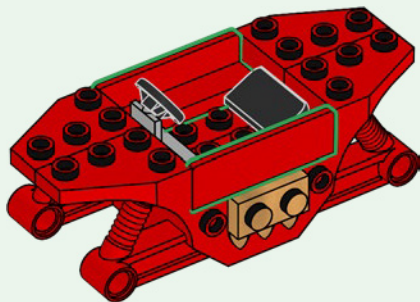

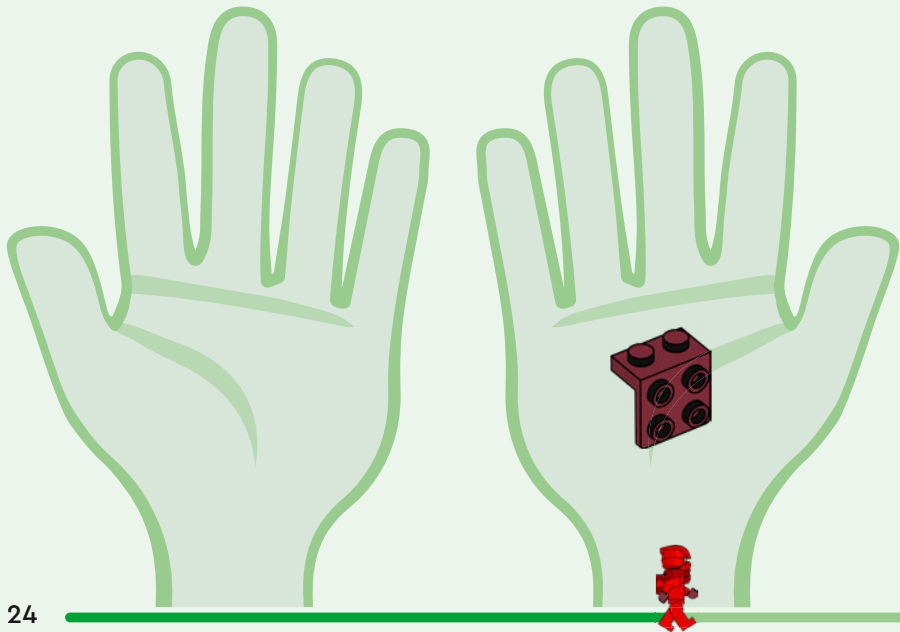

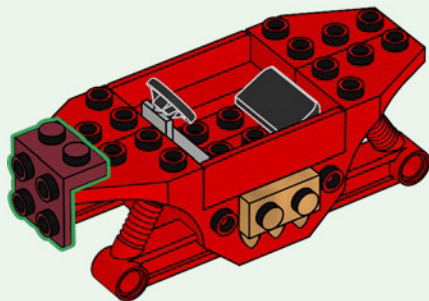

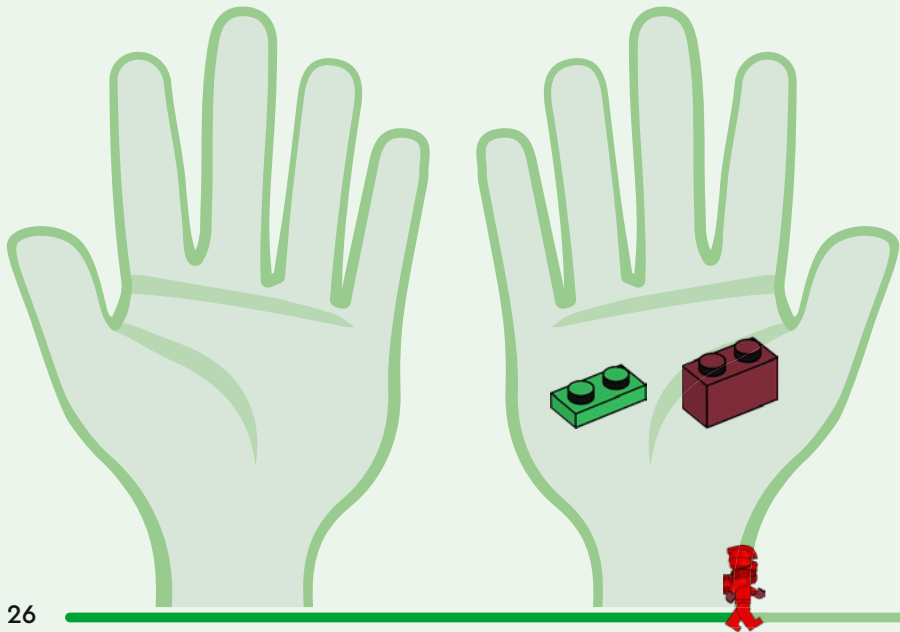

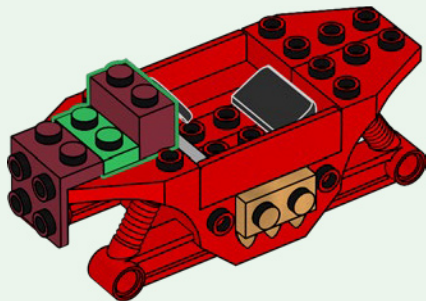

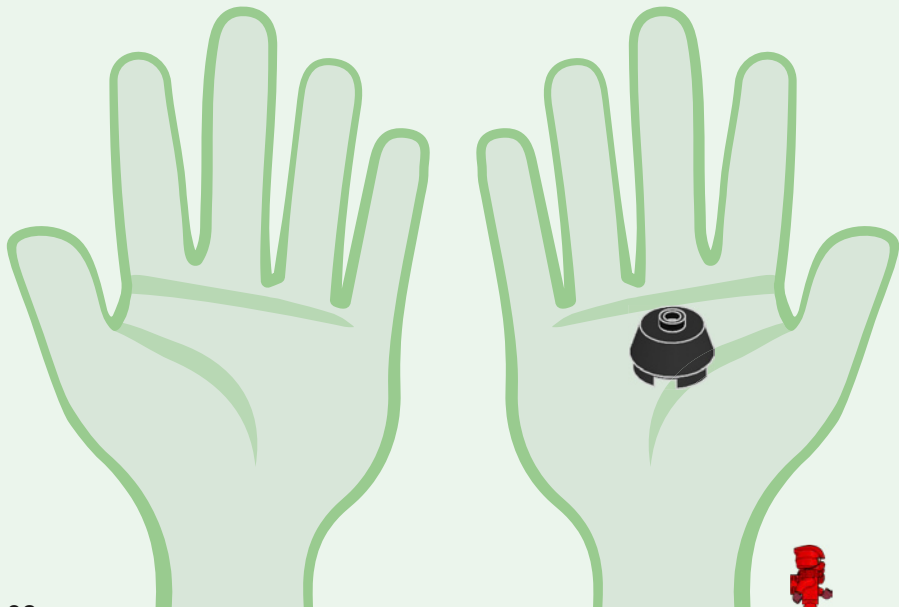

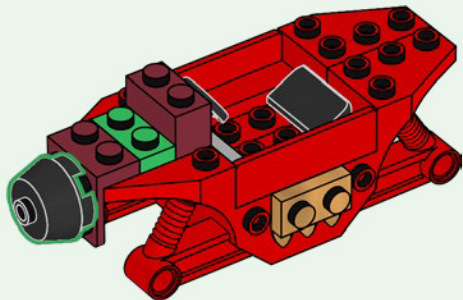

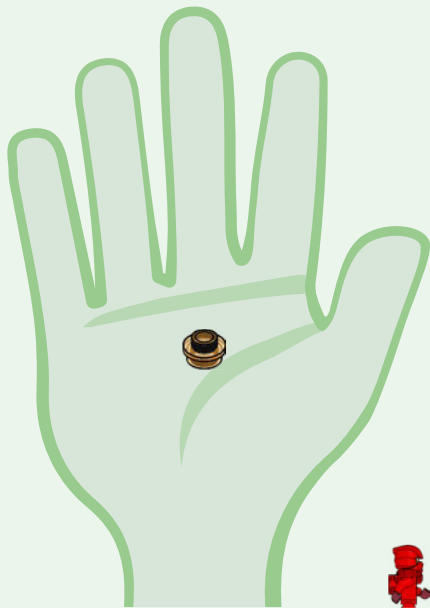

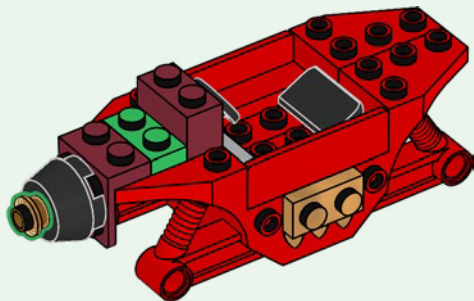

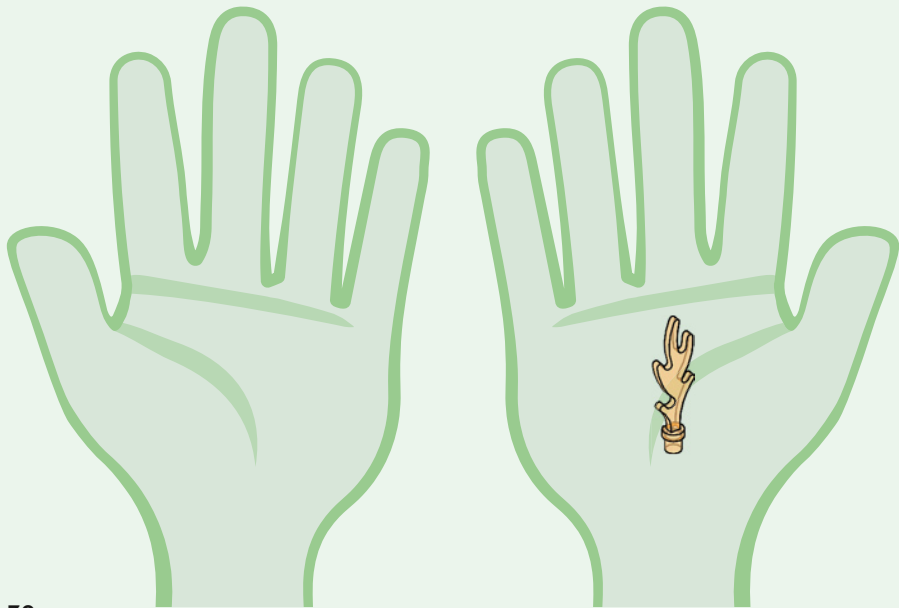

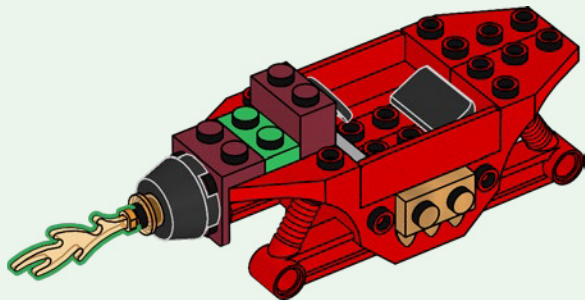

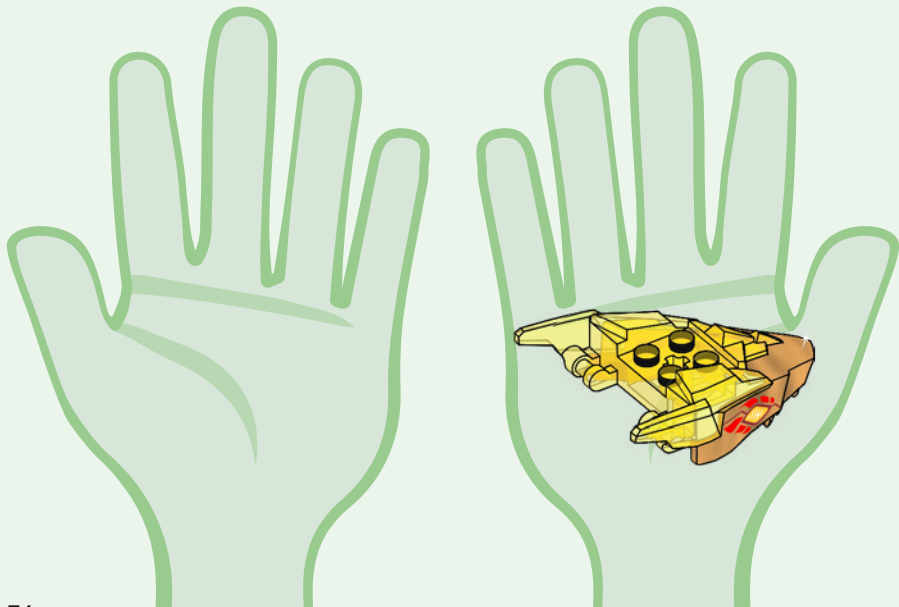

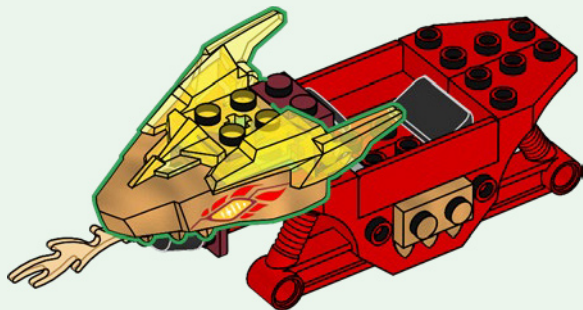

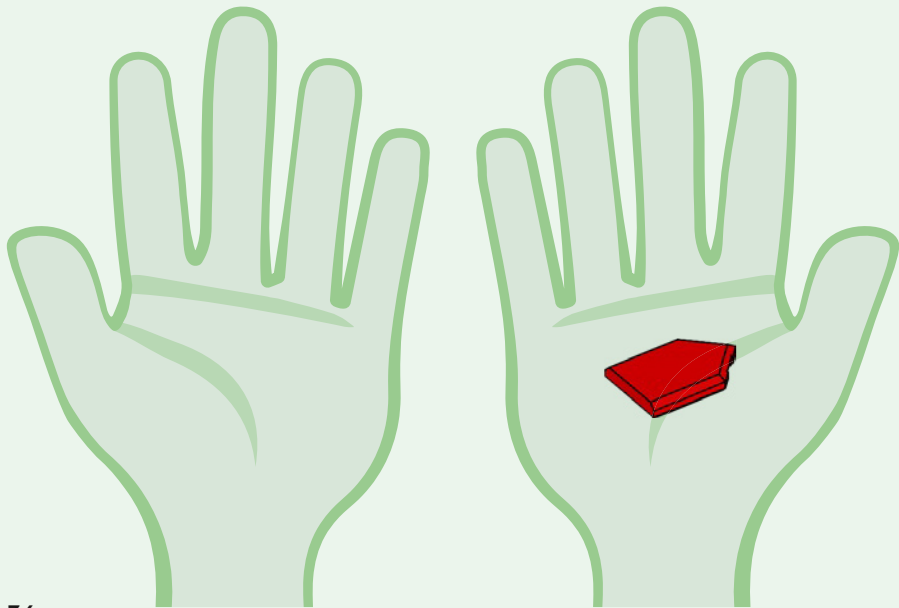

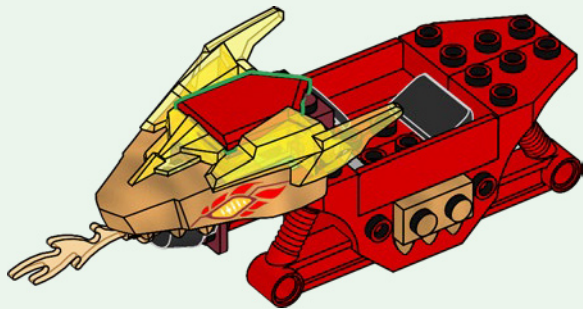

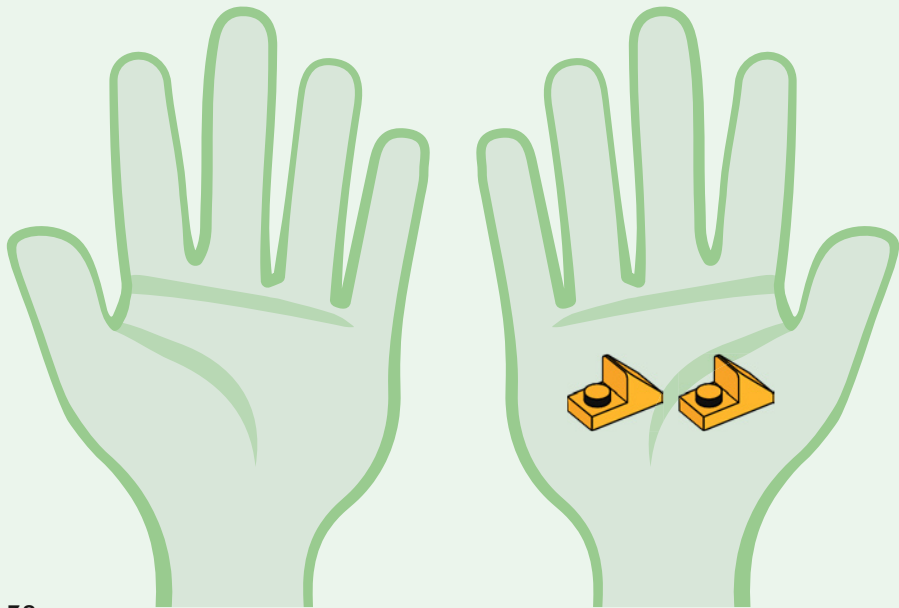

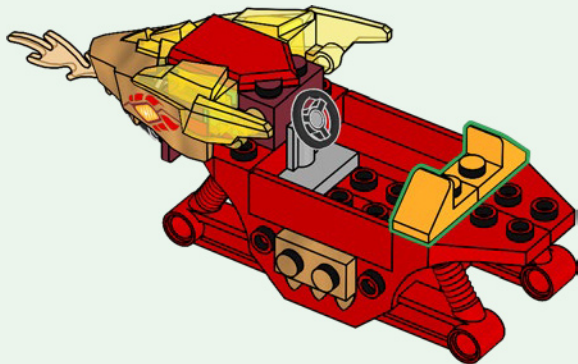

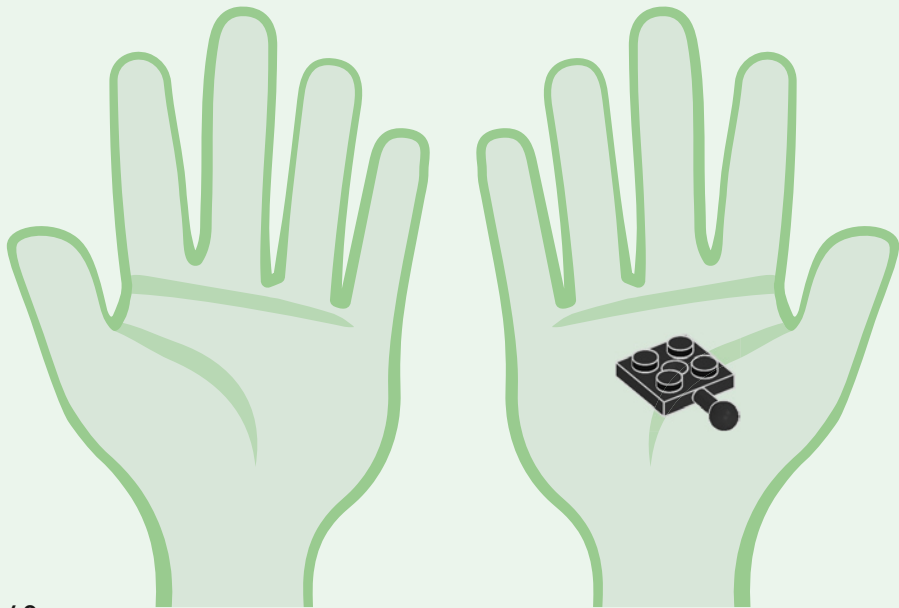

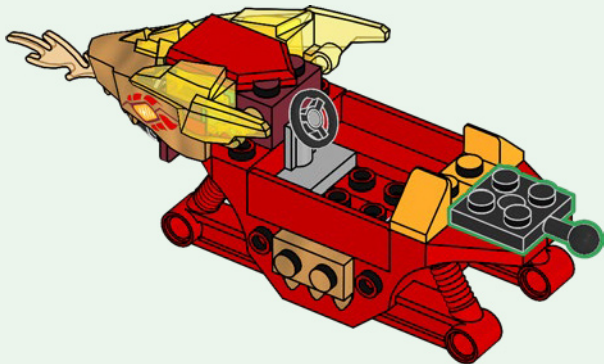

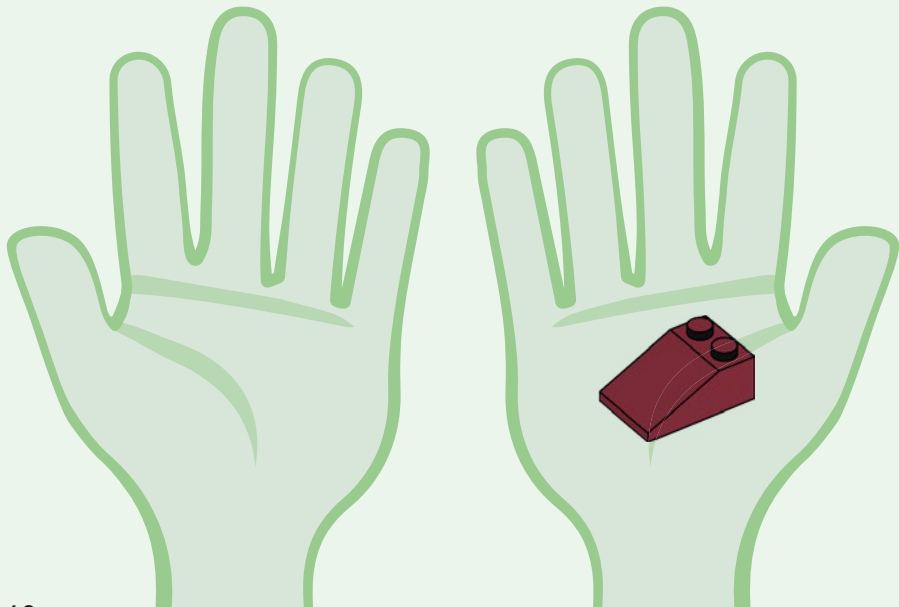

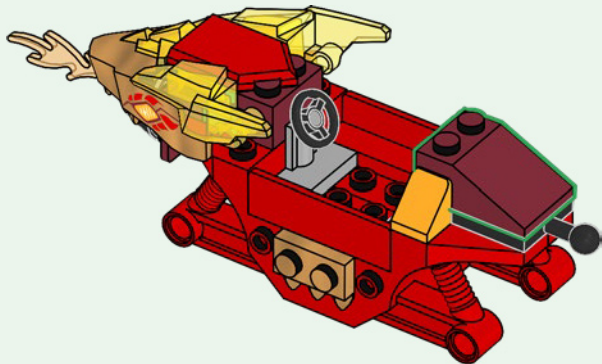

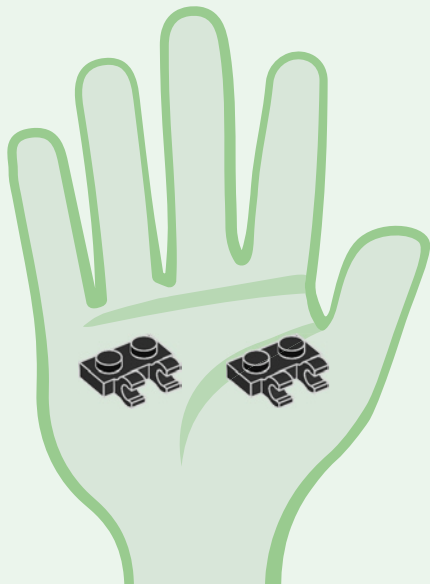
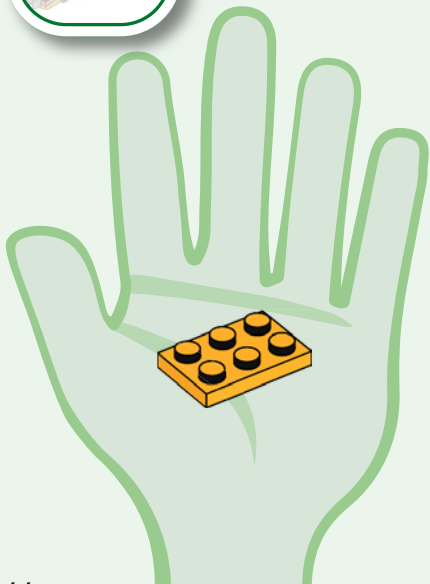

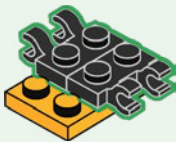

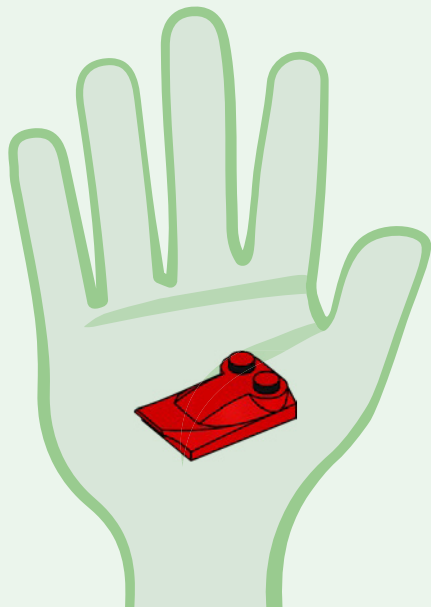
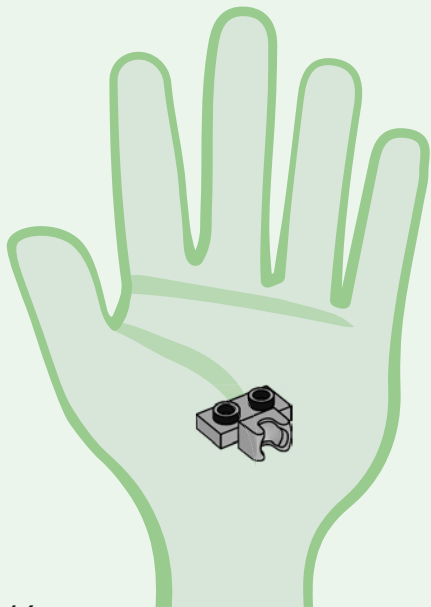

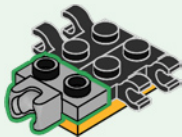

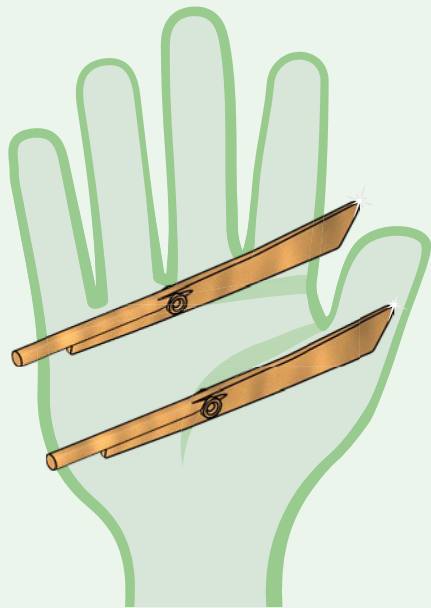

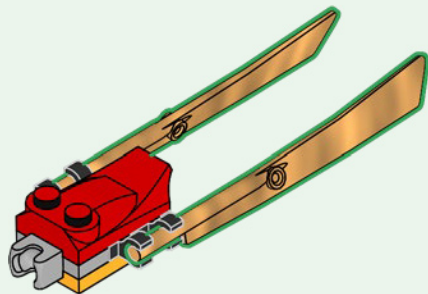

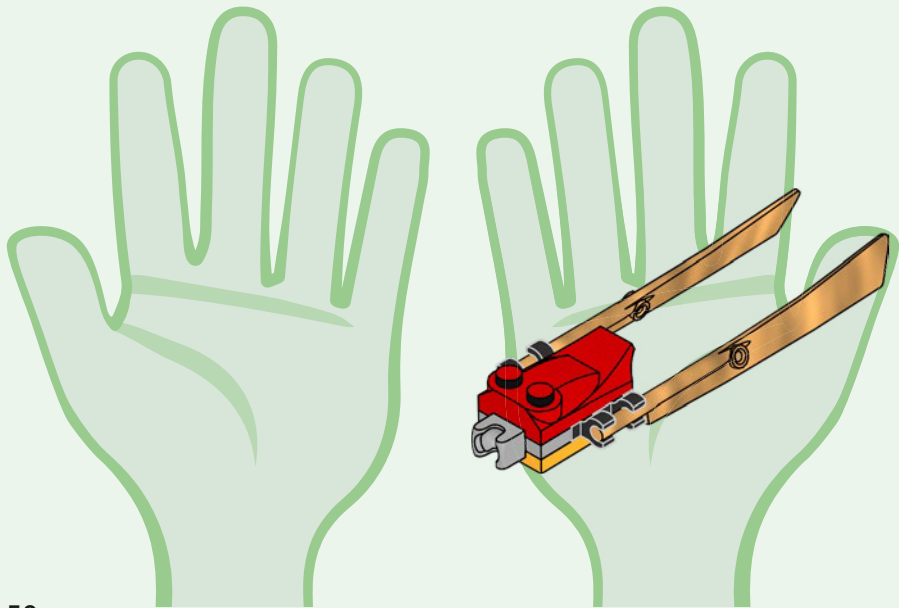

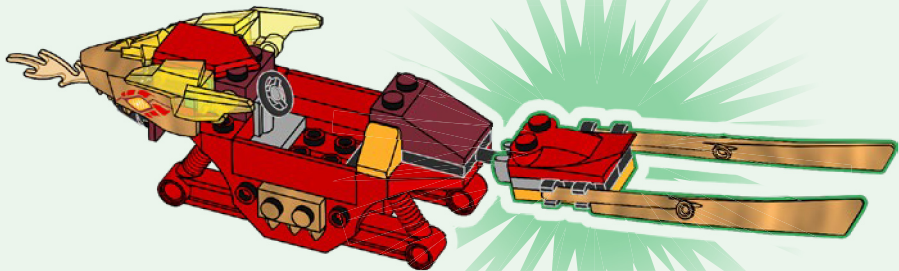

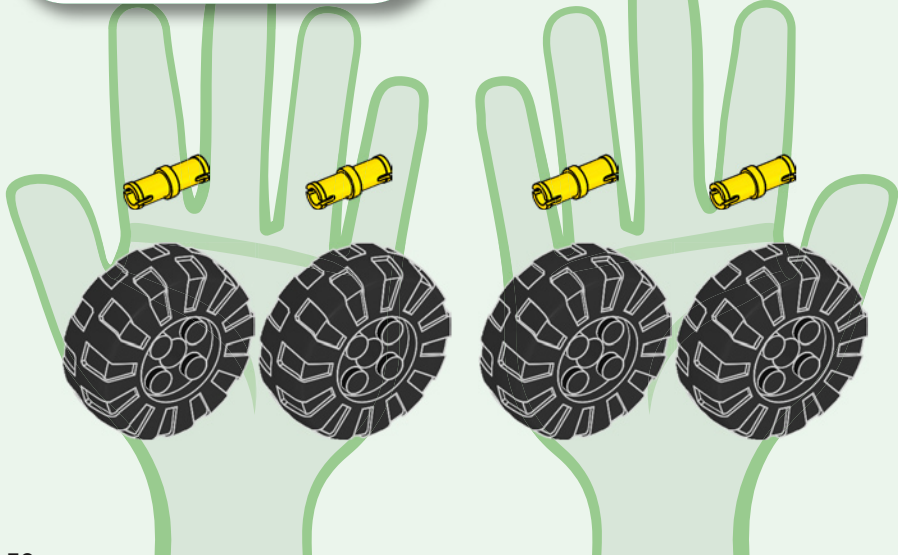
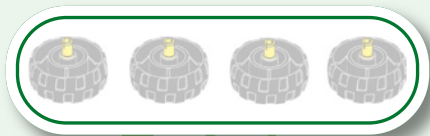

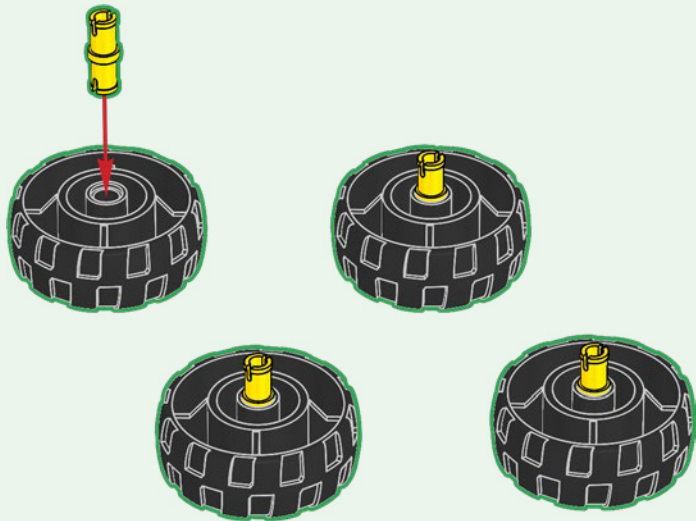

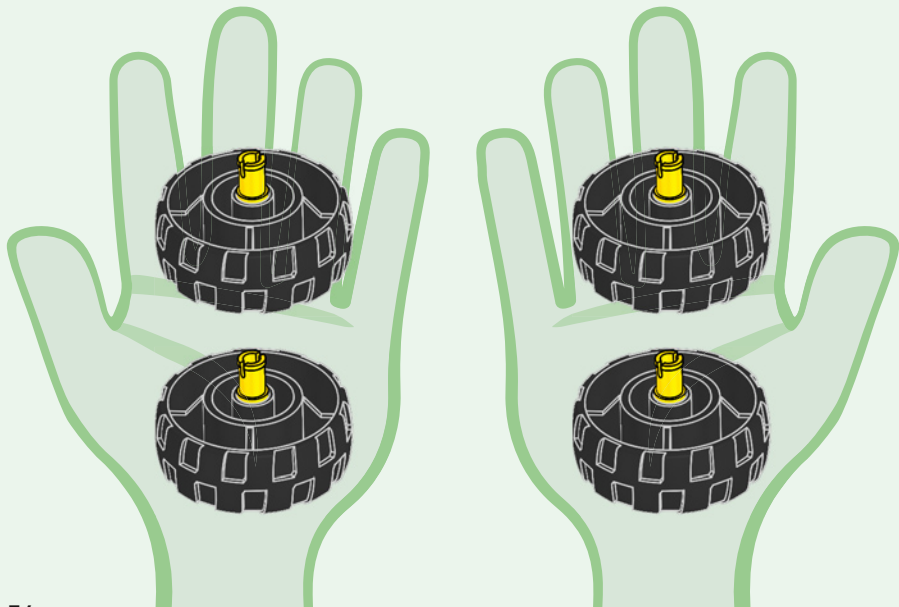

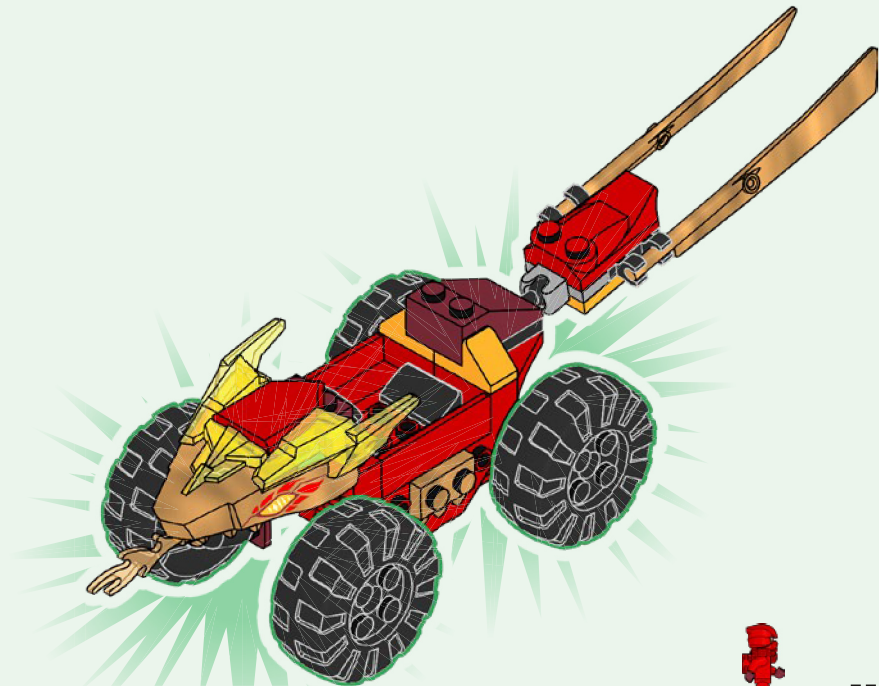

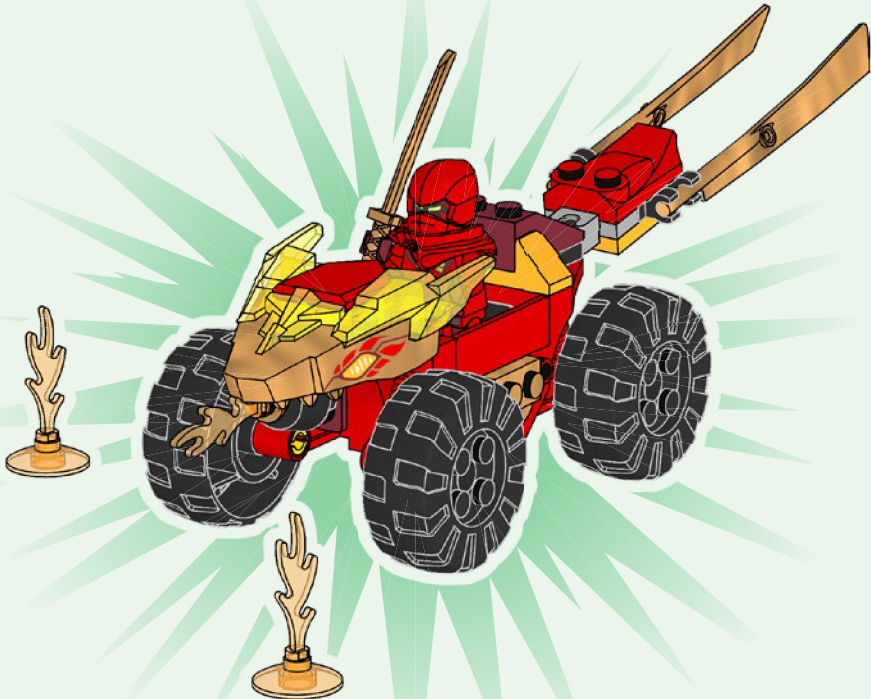

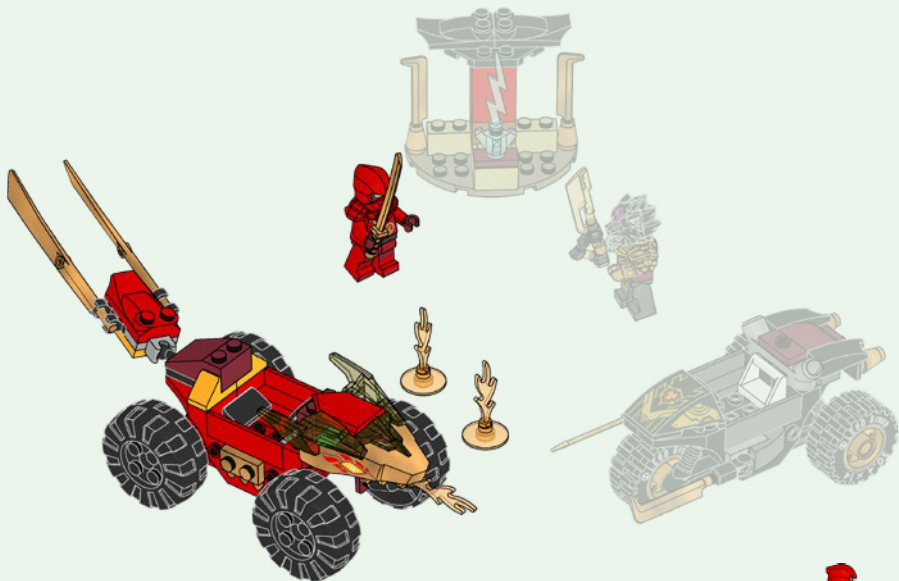



NINJAGO

DRAGONS RISING





71799



71796



71792



71793



71794



Rebuild
the
world™





NINJAGO

DRAGONS RISING

71789





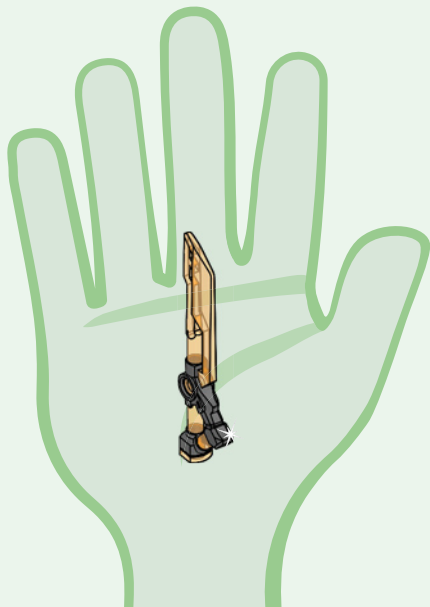



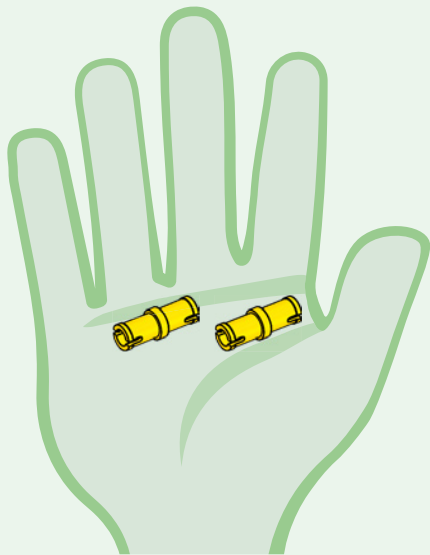
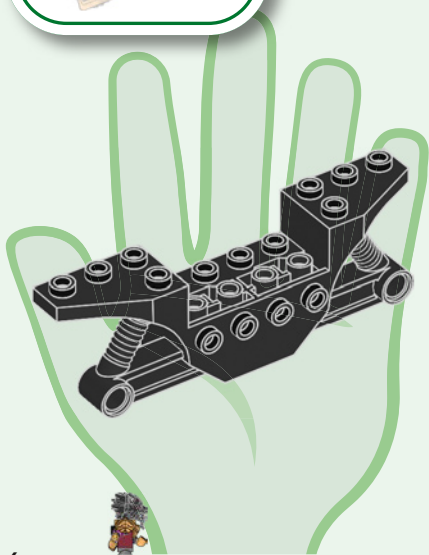

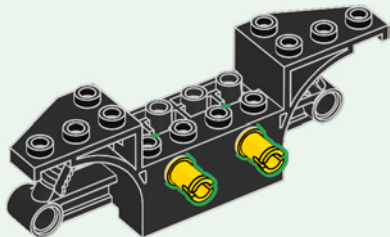
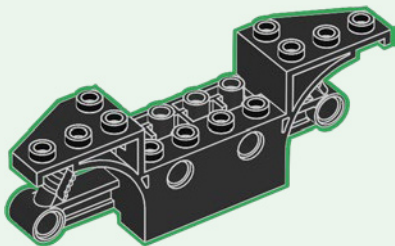

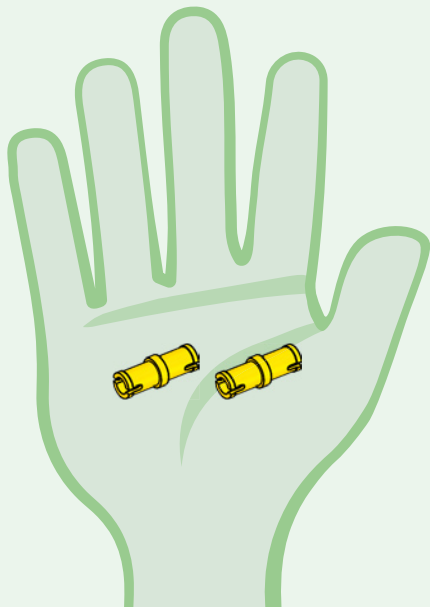

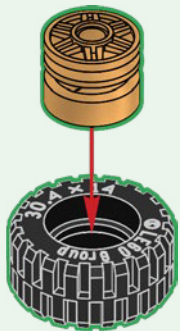



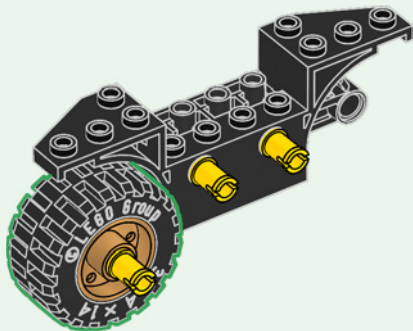

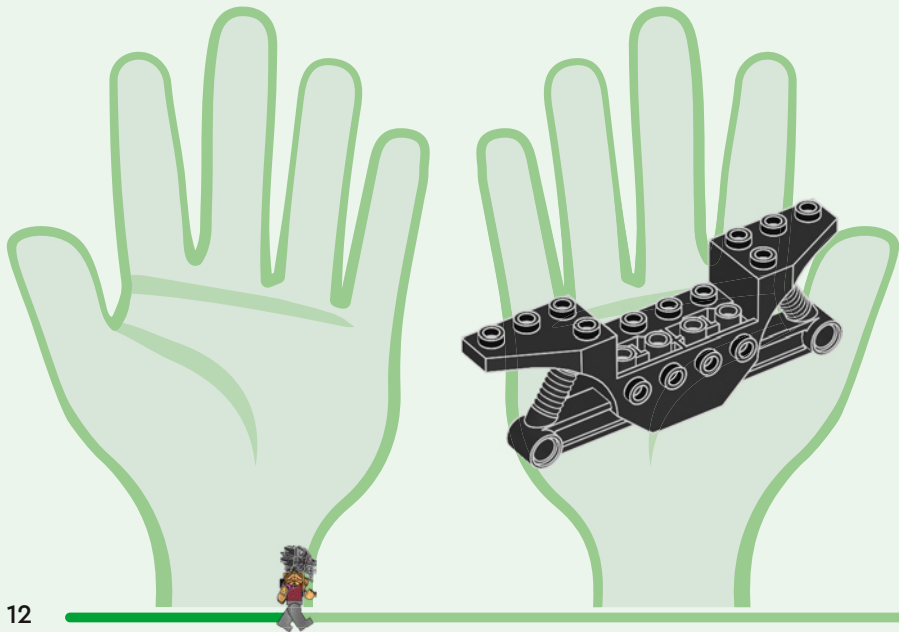

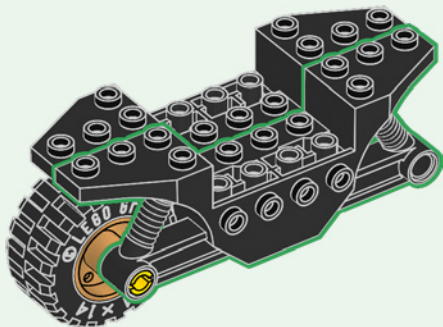

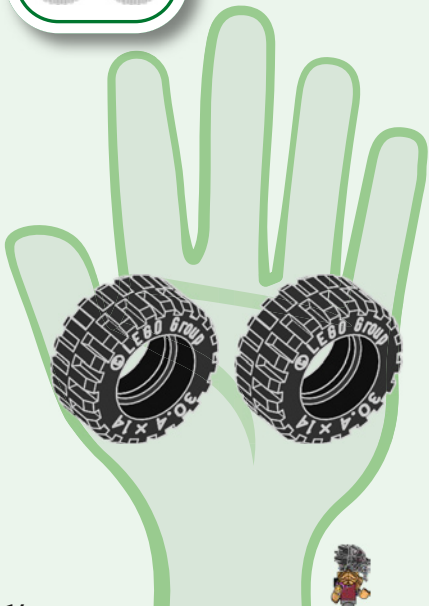

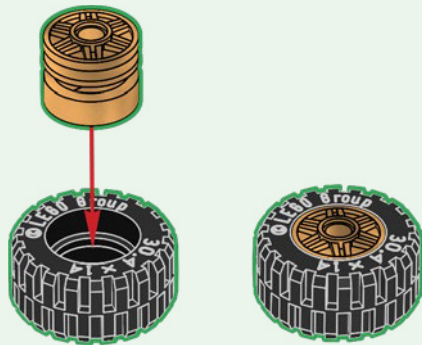

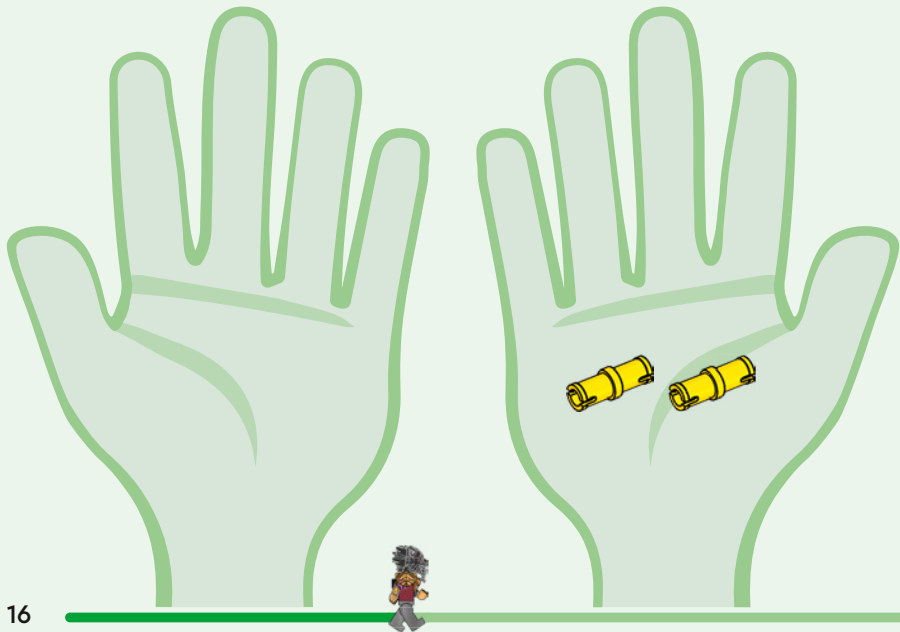

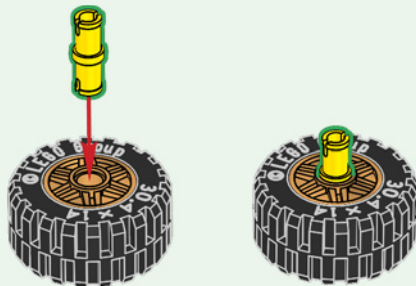



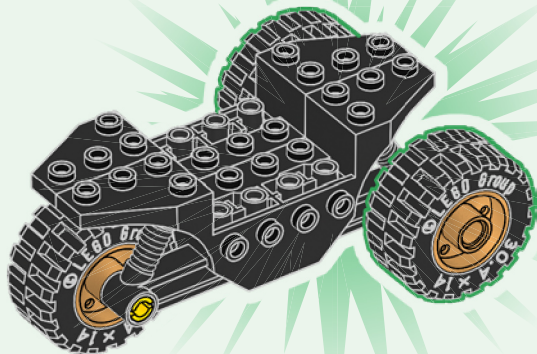

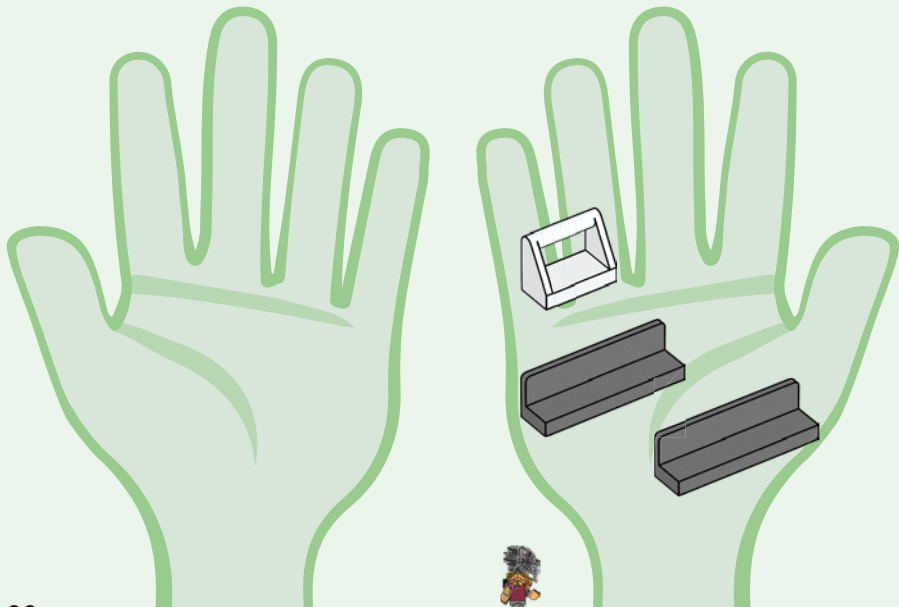

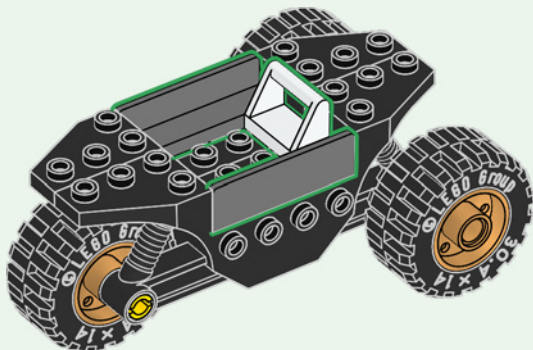

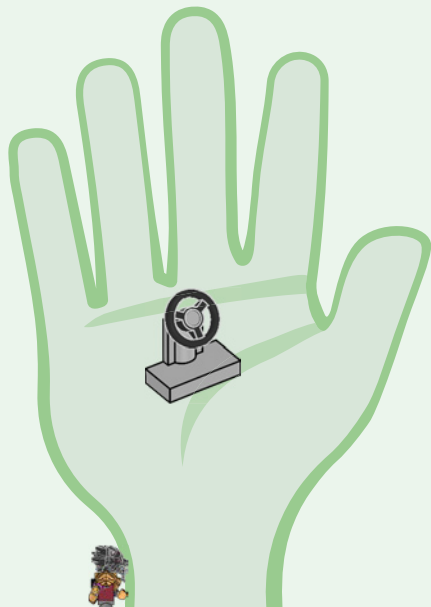

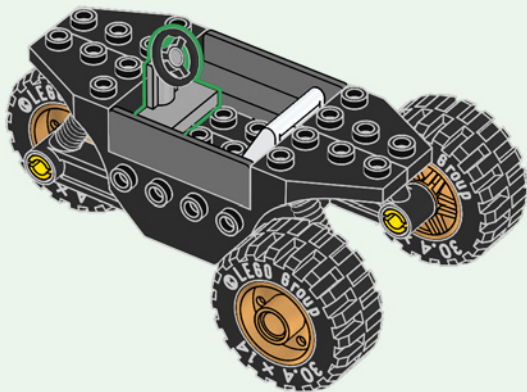



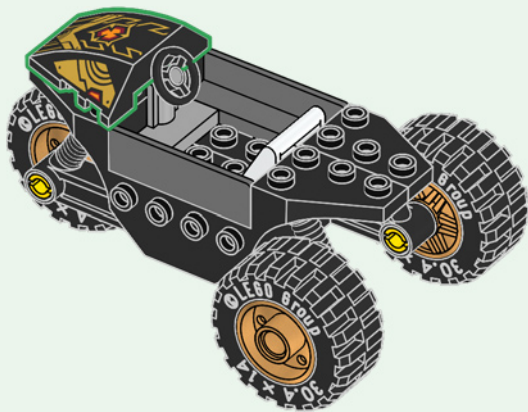

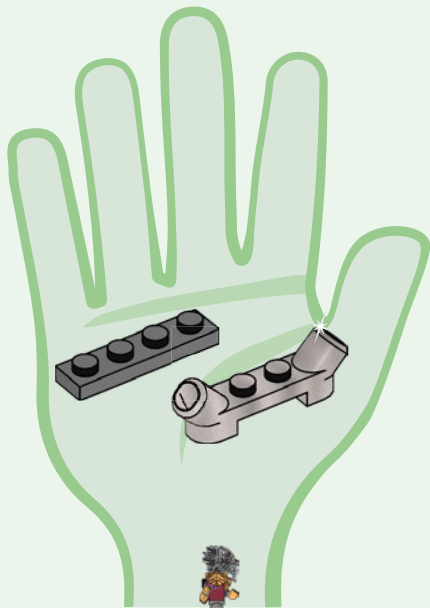

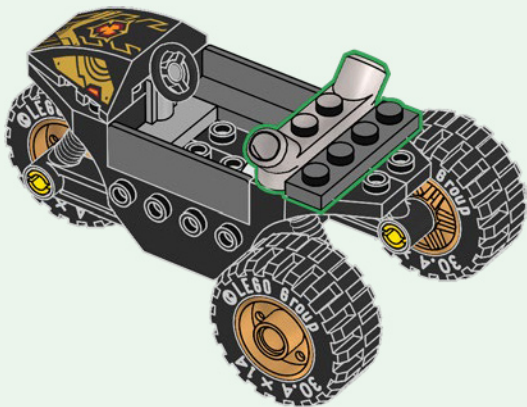

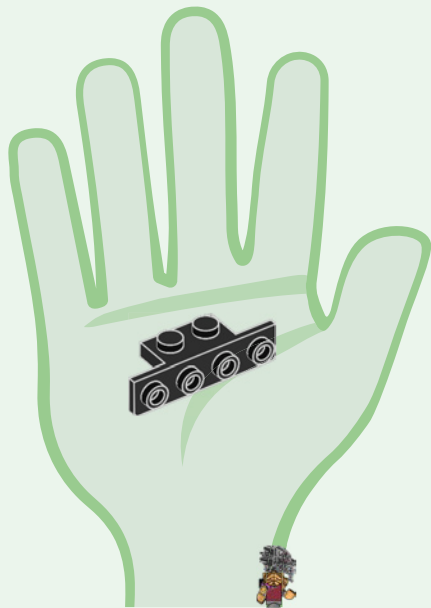

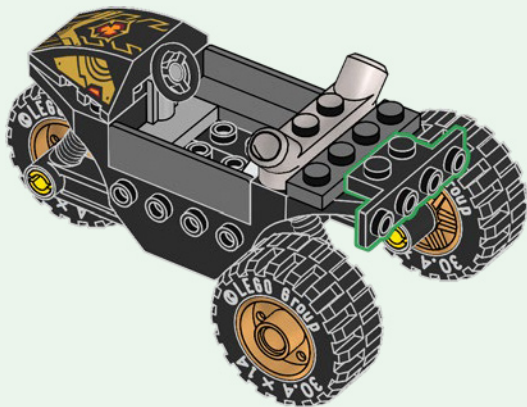

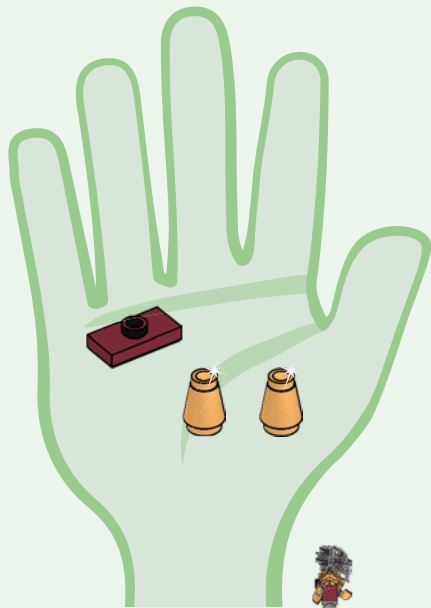

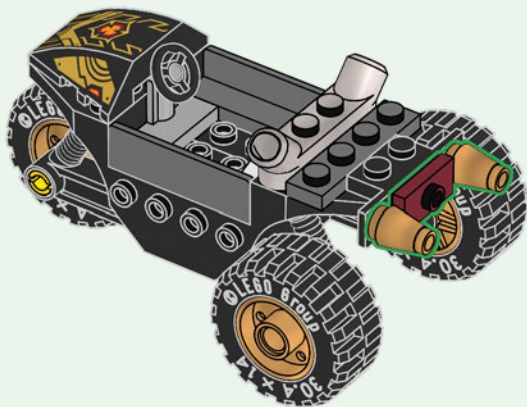

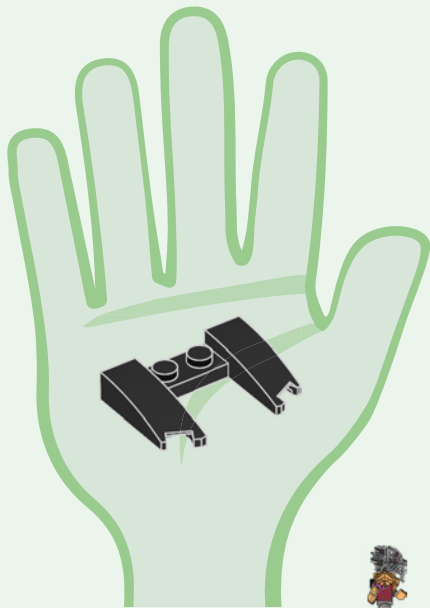

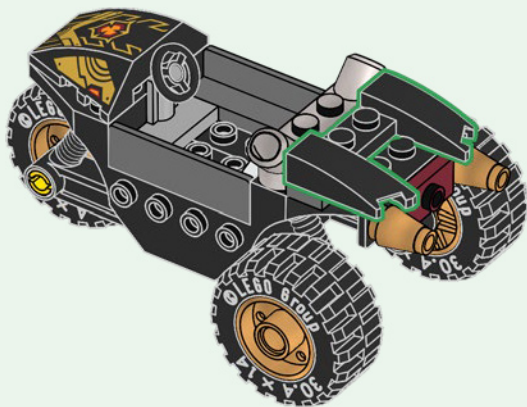

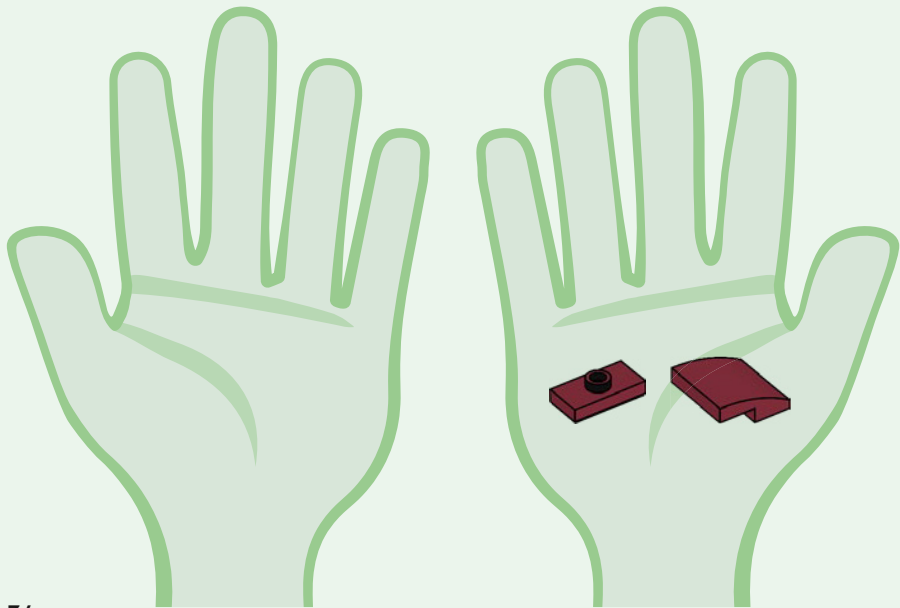

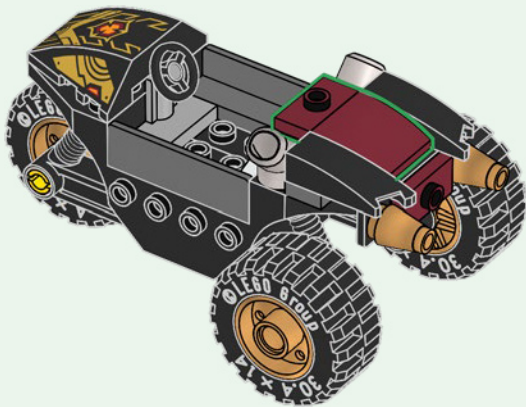

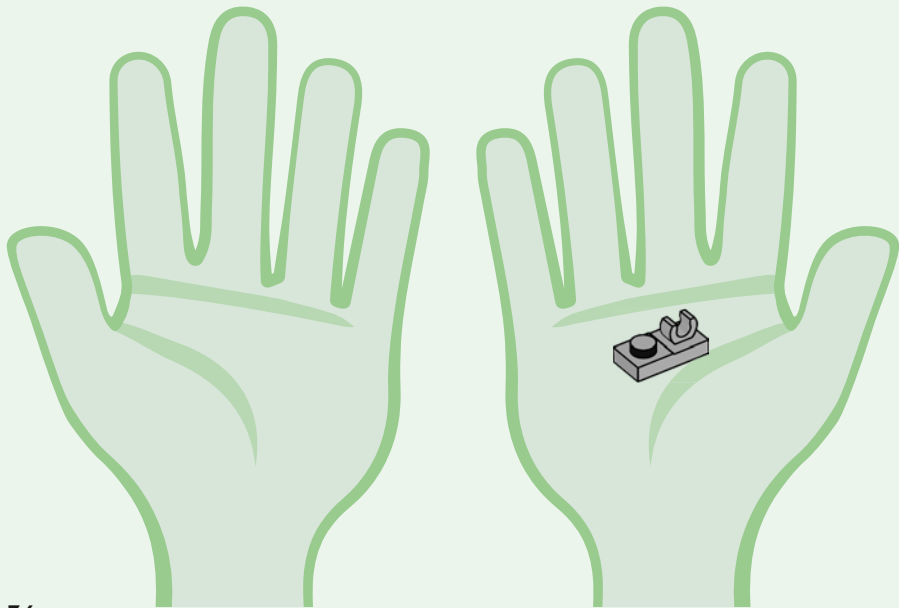

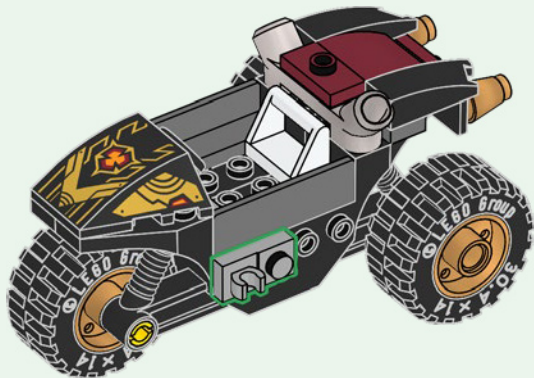

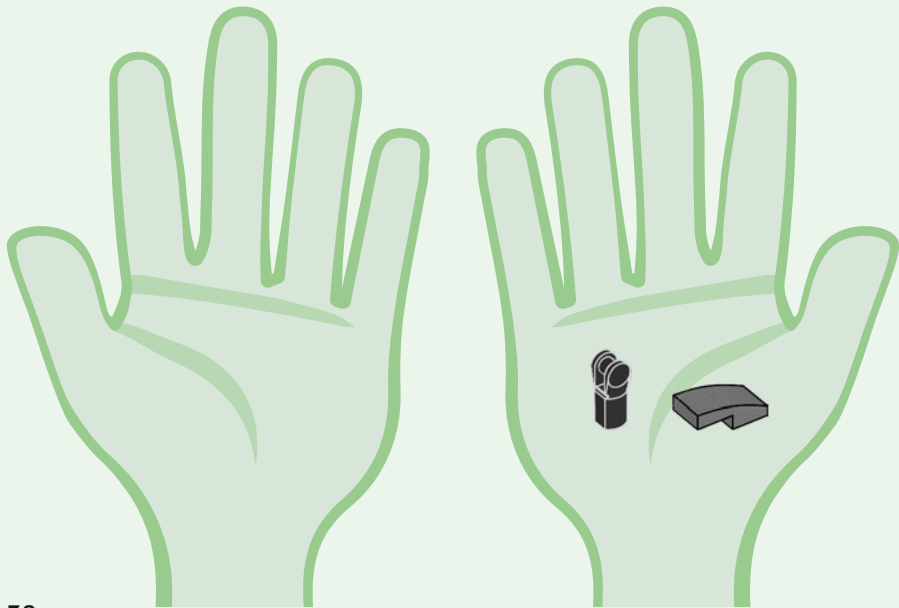

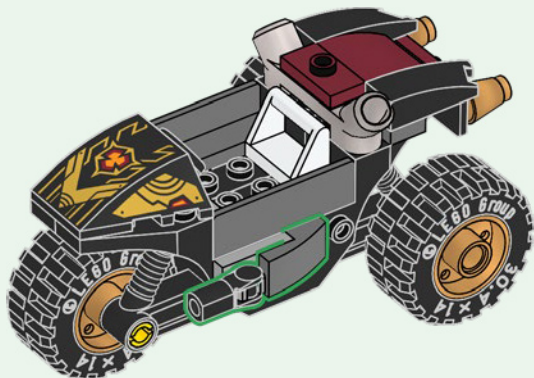

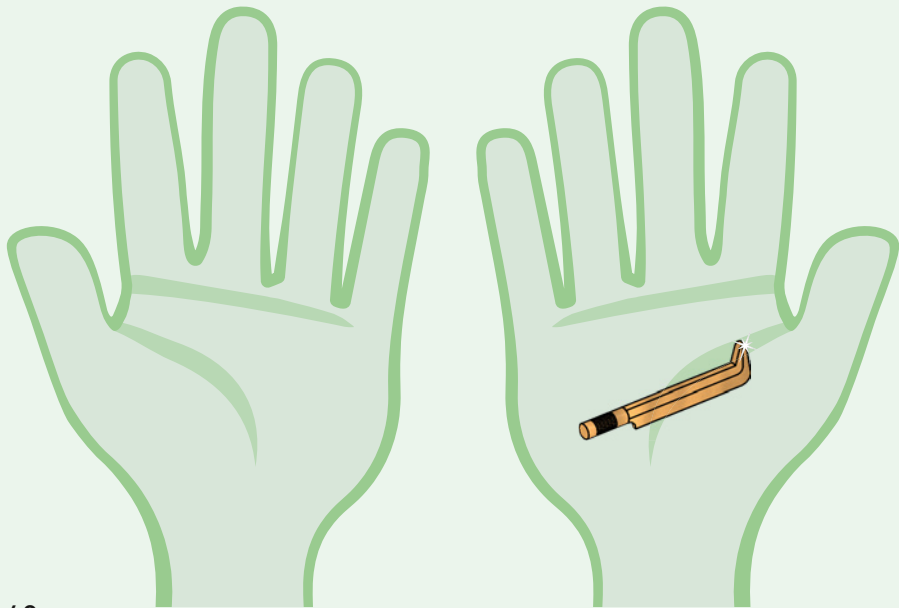

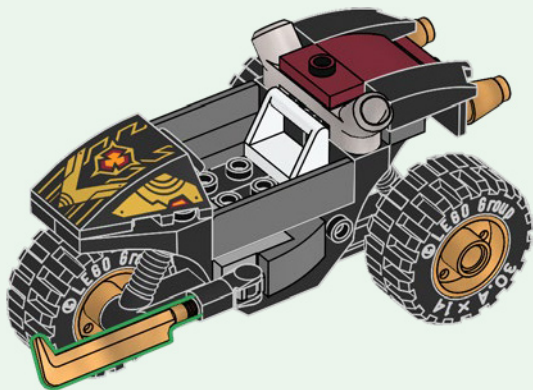

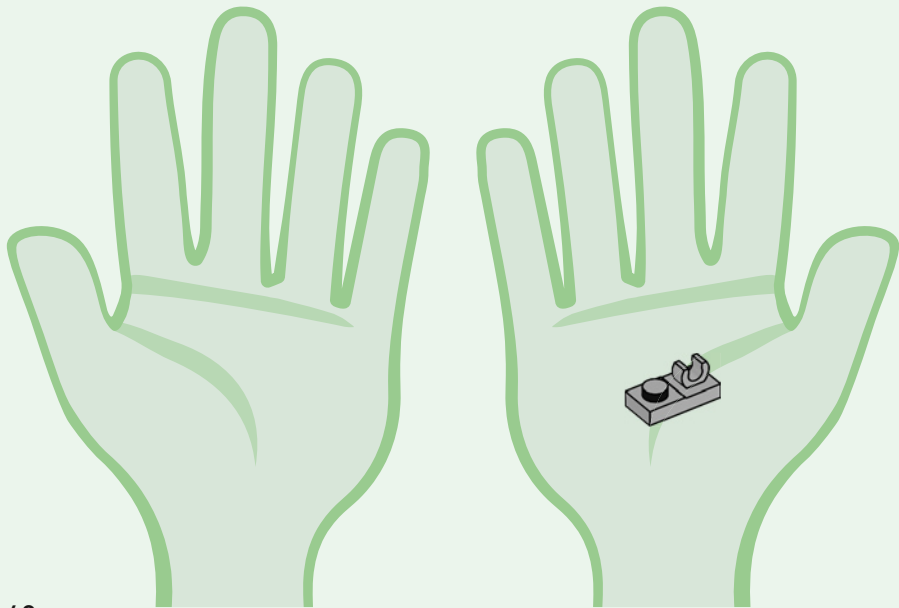

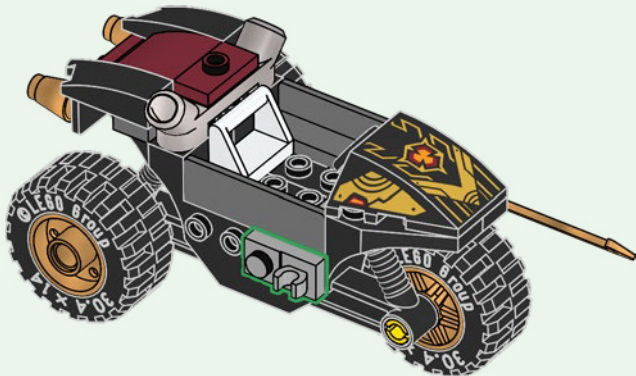

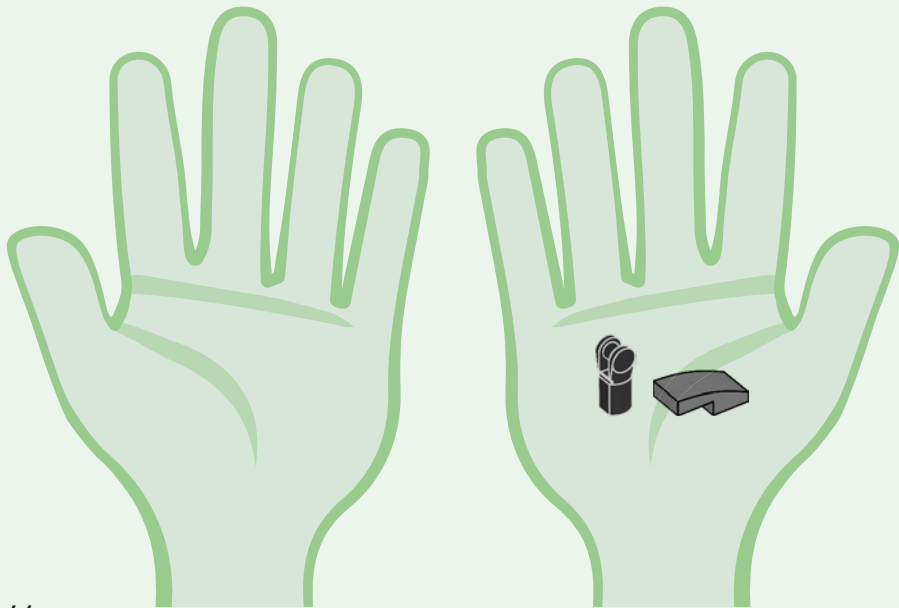

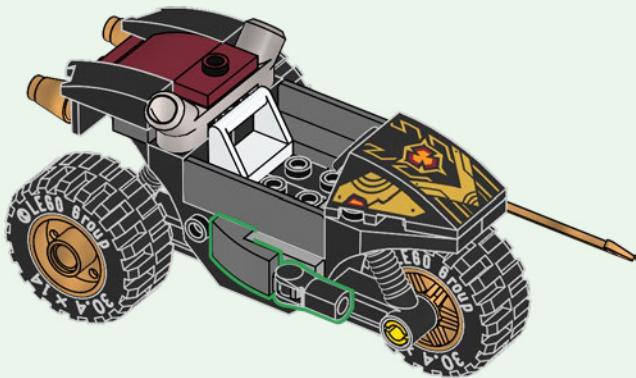

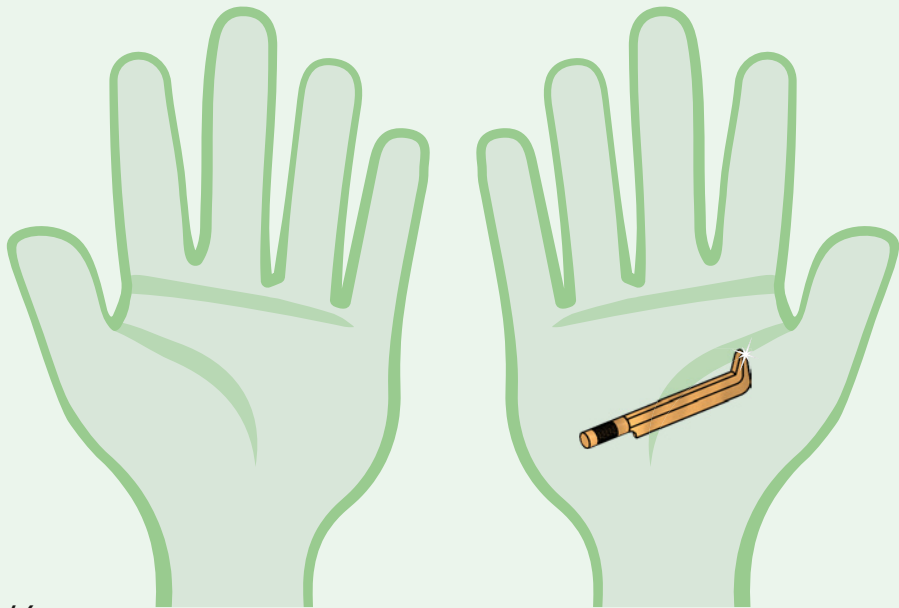

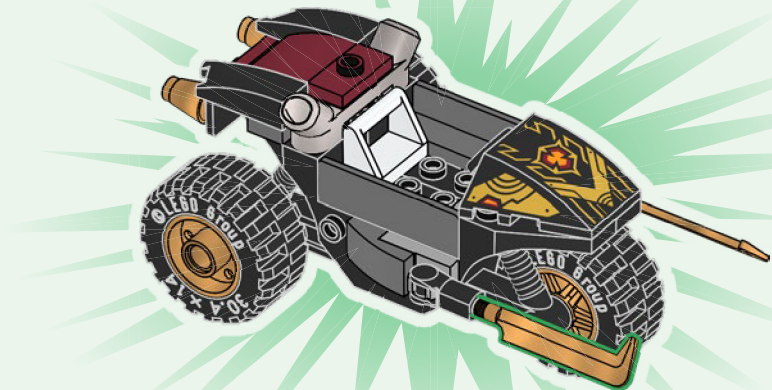

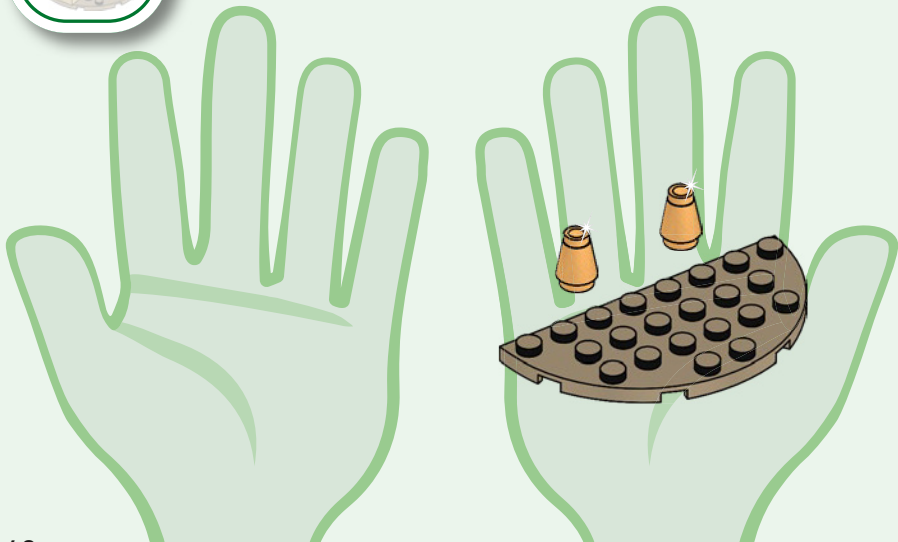

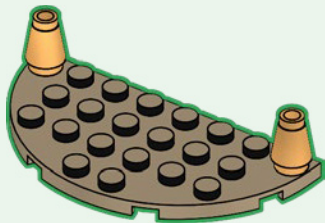

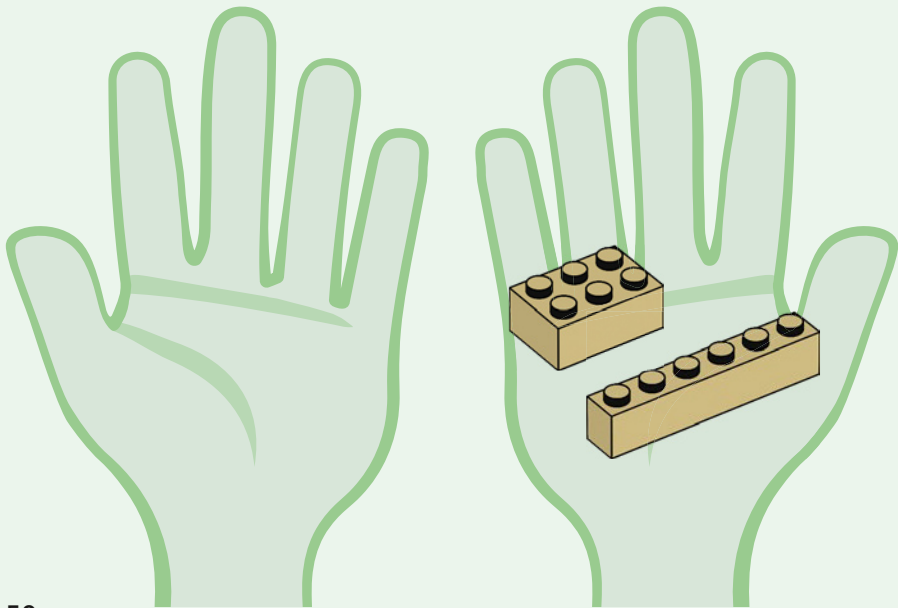

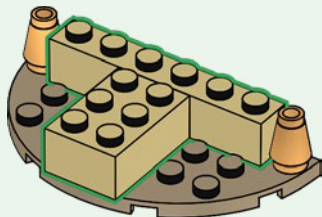

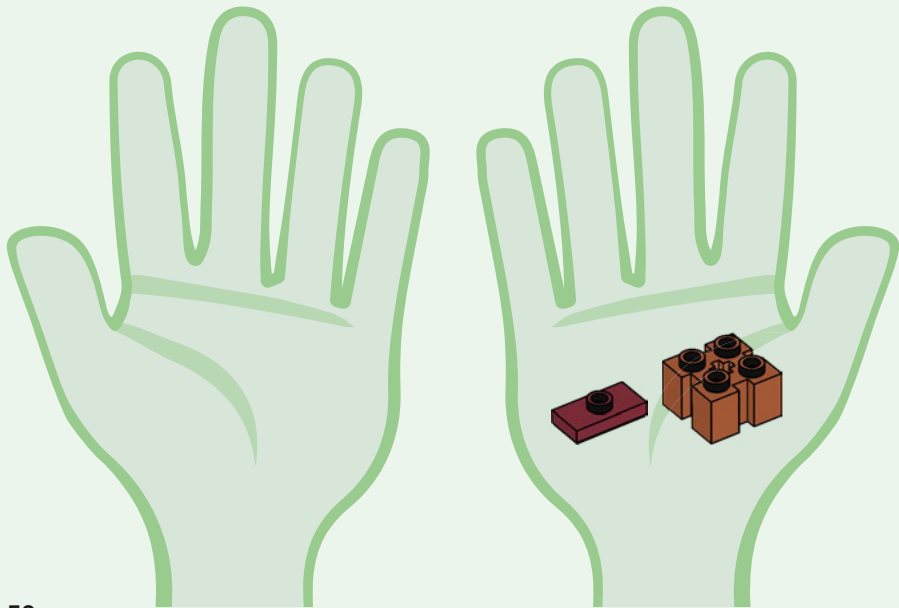

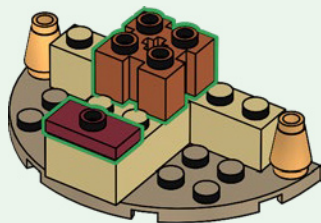

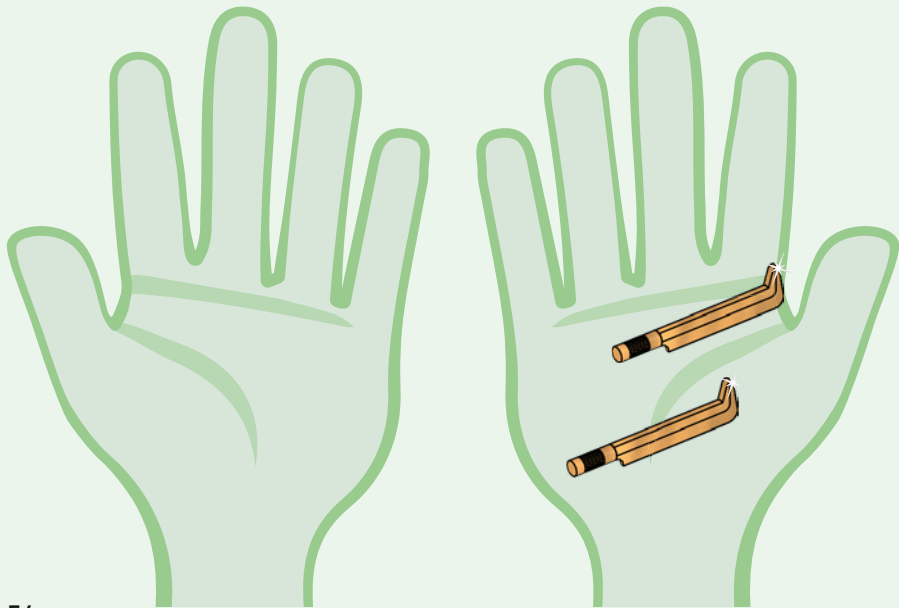

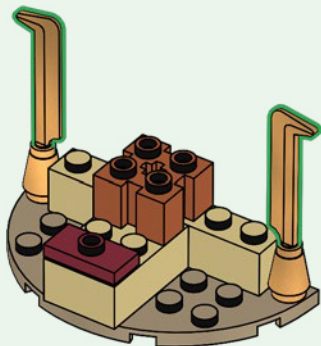

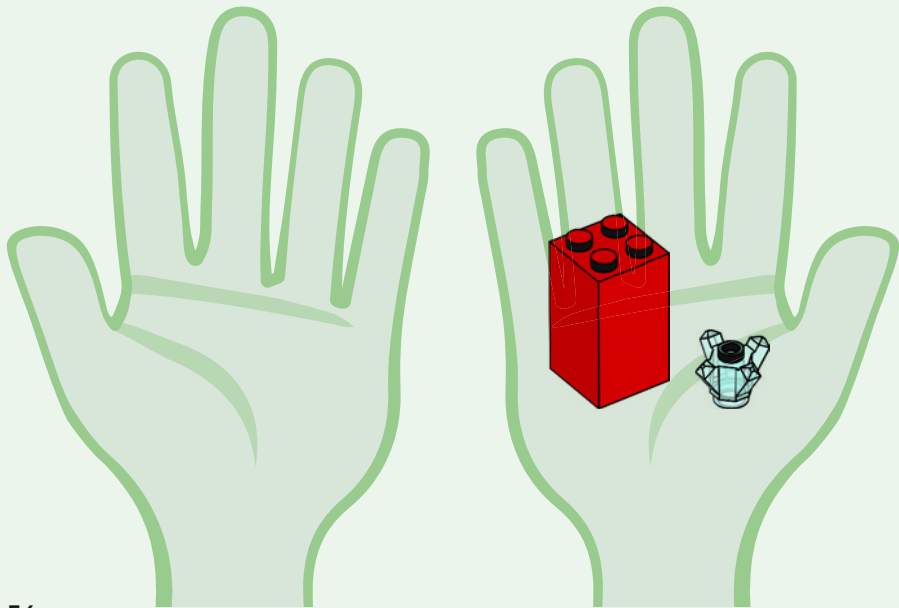

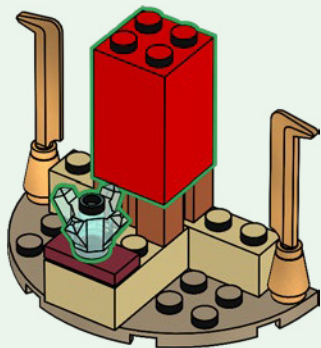

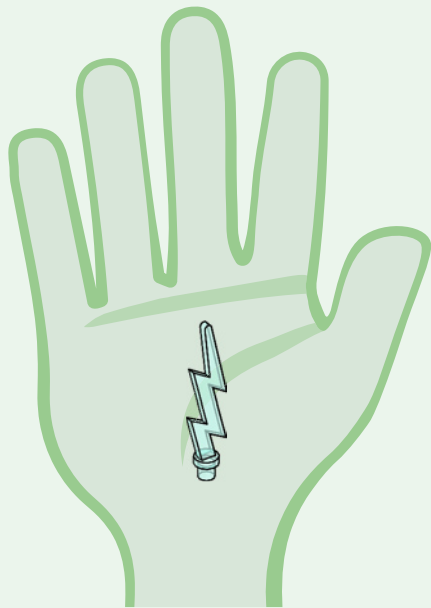

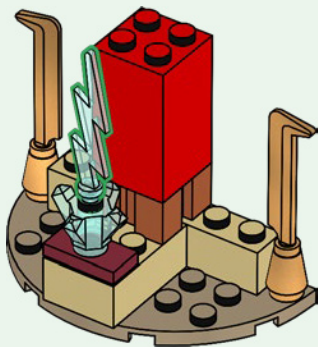

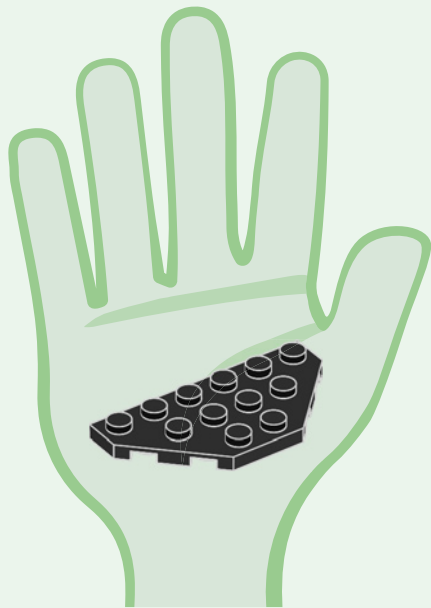

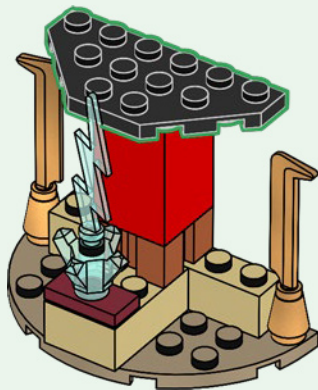

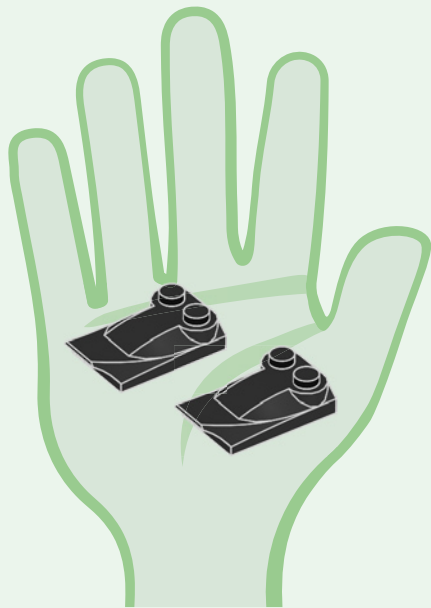
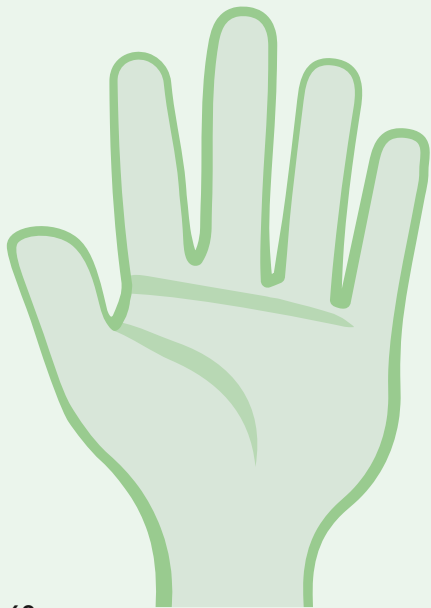



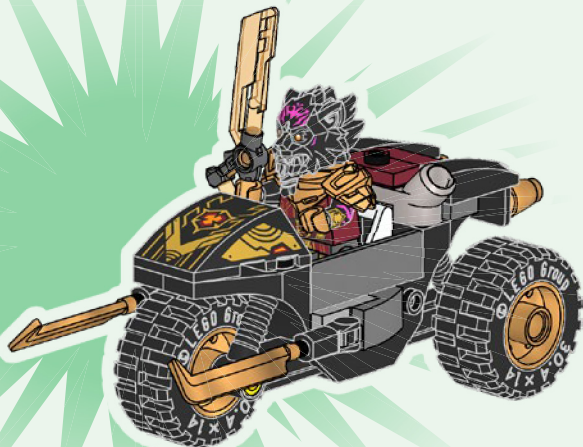

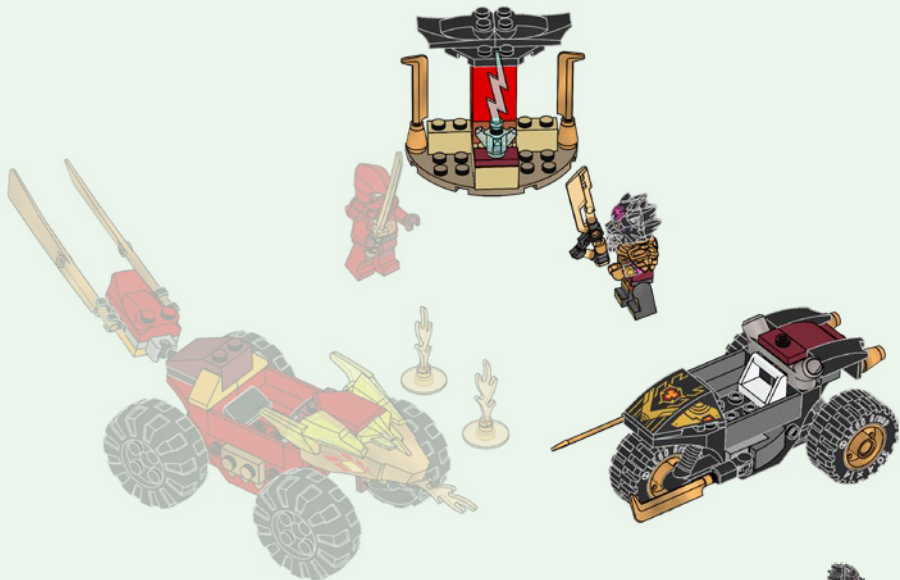



1x
6168590



1x
6248885



1x
302328



1x
6315198



1x
6434539



1x
6146989

66



3x
6092597



1x
4539102



1x
6267486



1x
6107758



1x
6437743



1x
6366021



1x
6174023



3x
6167741



1x
6430281



2x
6245310



2x
6330901



1x
6097503



2x
6029948



1x
4211001



2x
6092649



2x
6207764



3x
6109685



1x
6430283



4x
4529247



4x
6398659



1x
6116596



2x
6270131



1x
4632100



1x
6434482



1x
243201



1x
6043656



2x
6326078



2x
4226995



1x
6437149



1x
6434429



1x
6437147



1x
6294045



1x
6438255



2x
6046379



1x
6143425



1x
6138839

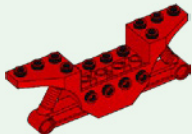

2x
6320082



1x
4159739

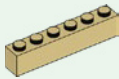

1x
4112982



1x
6434427



12x
6331822



1x
4548180



1x
6434480



2x
4285883



2x
6321194



1x
4653822



1x
6359224



1x
6168620



1x
6434501



3x
4619323



2x
6310268



1x
6179660



4x
6440829



1x
241926

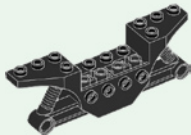

2x
6409846



[LEGO.com/service](https://www.LEGO.com/service)

YOU COULD

WIN



Scan this QR code or go to
LEGO.COM/PRODUCTFEEDBACK and give us
your short feedback about this LEGO® set
for a chance to win a cool LEGO prize.

Terms and Conditions apply*

EN: YOU COULD WIN. Terms and Conditions apply* **DE: Du könntest GEWINNEN.** Es gelten die Teilnahmebedingungen* **FR: Tu pourrais GAGNER.** Des conditions s'appliquent* **IT: Potresti VINCERE tu.** Termini e condizioni sono applicabili* **ES: Puedes GANAR.** Aplican términos y condiciones* **PT: Poderá GANHAR.** Aplicam-se termos e condições* **ZH: 轻松获奖.** 条款和条件适用* **PL: Szansa na WYGRANĄ.** Obowiązują warunki korzystania* **CS: Máte šanci VYHRÁT.** Platí všeobecné smluvní podmínky* **SK: Máte šancu VYHRÁT.** Platia všeobecné zmluvné podmienky* **HU: TE IS NYERHETSZ.** Felhasználási feltételek érvényesek* **RO: Ai putea CÂȘTIGA.** Se aplică termenii și condiții* **BG: Можете да СПЕЧЕЛИТЕ.** Има определени правила и условия* **LV: Tu vari LAIMĒT.** Ir spēkā noteikumi un nosacījumi.* **ET: Sul on võimalus VÕITA.** Kehtivad tingimused* **LT: Jūs galite LAIMĖTI.** Taikomos sąlygos*

*[LEGO.com/productfeedback-terms](https://www.lego.com/productfeedback-terms)

LEGO, the LEGO logo and NINJAGO are trademarks of the LEGO Group. ©2023 The LEGO Group.

6466998